



US00D838467S

(12) **United States Design Patent**  
**Hughes**

(10) **Patent No.:** **US D838,467 S**

(45) **Date of Patent:** **\*\* Jan. 22, 2019**

- (54) **FLIP FLOP HEEL BAND**
- (71) Applicant: **Richard D Hughes**, Aurora, CO (US)
- (72) Inventor: **Richard D Hughes**, Aurora, CO (US)
- (\*\*) Term: **15 Years**
- (21) Appl. No.: **29/596,906**
- (22) Filed: **Mar. 13, 2017**
- (51) **LOC (11) Cl.** ..... **02-99**
- (52) **U.S. Cl.**  
USPC ..... **D2/978**; D2/916; D2/976
- (58) **Field of Classification Search**  
USPC ..... D2/896, 916-918, 946, 968, 969, 976,  
D2/977, 978  
CPC ..... A43B 3/105; A43B 3/122; A43B 3/12;  
A43B 9/00; A43B 23/28; A43C 11/08;  
E05C 17/36  
See application file for complete search history.

- D719,341 S \* 12/2014 Lee ..... E05C 17/36  
D2/978
- D732,286 S \* 6/2015 Romo ..... A43B 3/105  
D2/946
- D769,609 S \* 10/2016 Rhymes ..... A43B 23/28  
D2/946

\* cited by examiner

*Primary Examiner* — Rashida C. Walshon  
(74) *Attorney, Agent, or Firm* — Patent Law Offices of  
Rick Martin, P.C.

(57) **CLAIM**

The ornamental design for a flip flop heel band, as shown  
and described.

**DESCRIPTION**

FIG. 1 is a front perspective view for my flip flop heel band;  
FIG. 2 is a left elevation view of my design;  
FIG. 3 is a right elevation view of my design;  
FIG. 4 is a front elevation view of my design;  
FIG. 5 is a top plan view of my design in a neutral mode;  
FIG. 6 is a bottom plan view of my design;  
FIG. 7 is a rear elevation view of my design;  
FIG. 8 is a rear perspective view of my design in use;  
FIG. 9 is a top plan view of my design in use;  
FIG. 10 is a bottom plan view of my design in use;  
FIG. 11 is a right side elevation view of my design in use;  
FIG. 12 is a left side elevation view of my design in use;  
FIG. 13 is a rear elevation view of my design in use; and,  
FIG. 14 is a front elevation view of my design in use.  
The broken lines indicate logo and environmental uses for  
my new design and form no part of the claimed design.

**1 Claim, 7 Drawing Sheets**

- (56) **References Cited**  
U.S. PATENT DOCUMENTS  
366,266 A \* 7/1887 Smithers ..... A43B 23/28  
36/58.5  
5,467,507 A \* 11/1995 Marsh ..... E05C 17/36  
24/298  
D591,037 S \* 4/2009 Ghee ..... D2/978  
7,823,299 B1 \* 11/2010 Brigham ..... A43B 3/105  
36/100  
D665,160 S \* 8/2012 Little-Thomas ..... D2/946  
D694,995 S \* 12/2013 Nguyen ..... D2/916

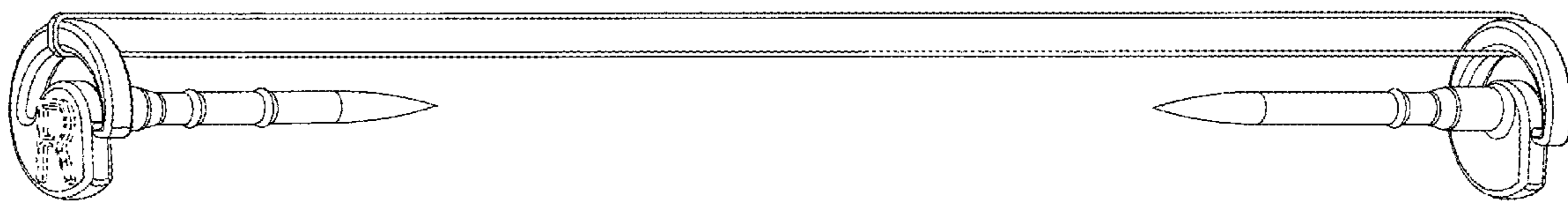

Fig. 1

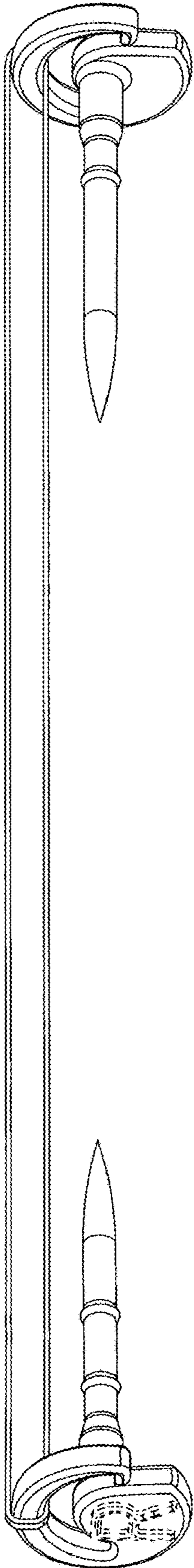

Fig. 2

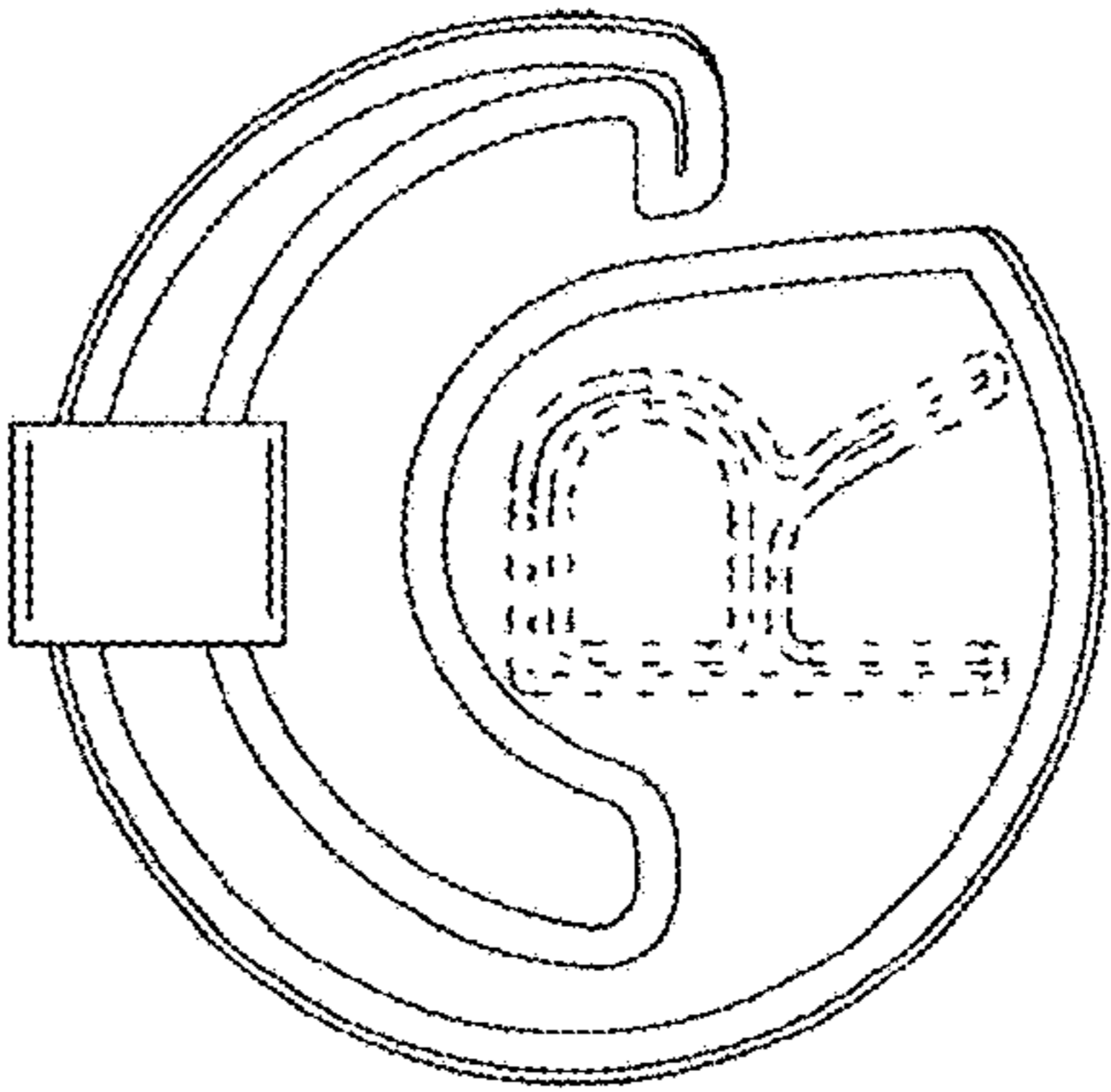

Fig. 3

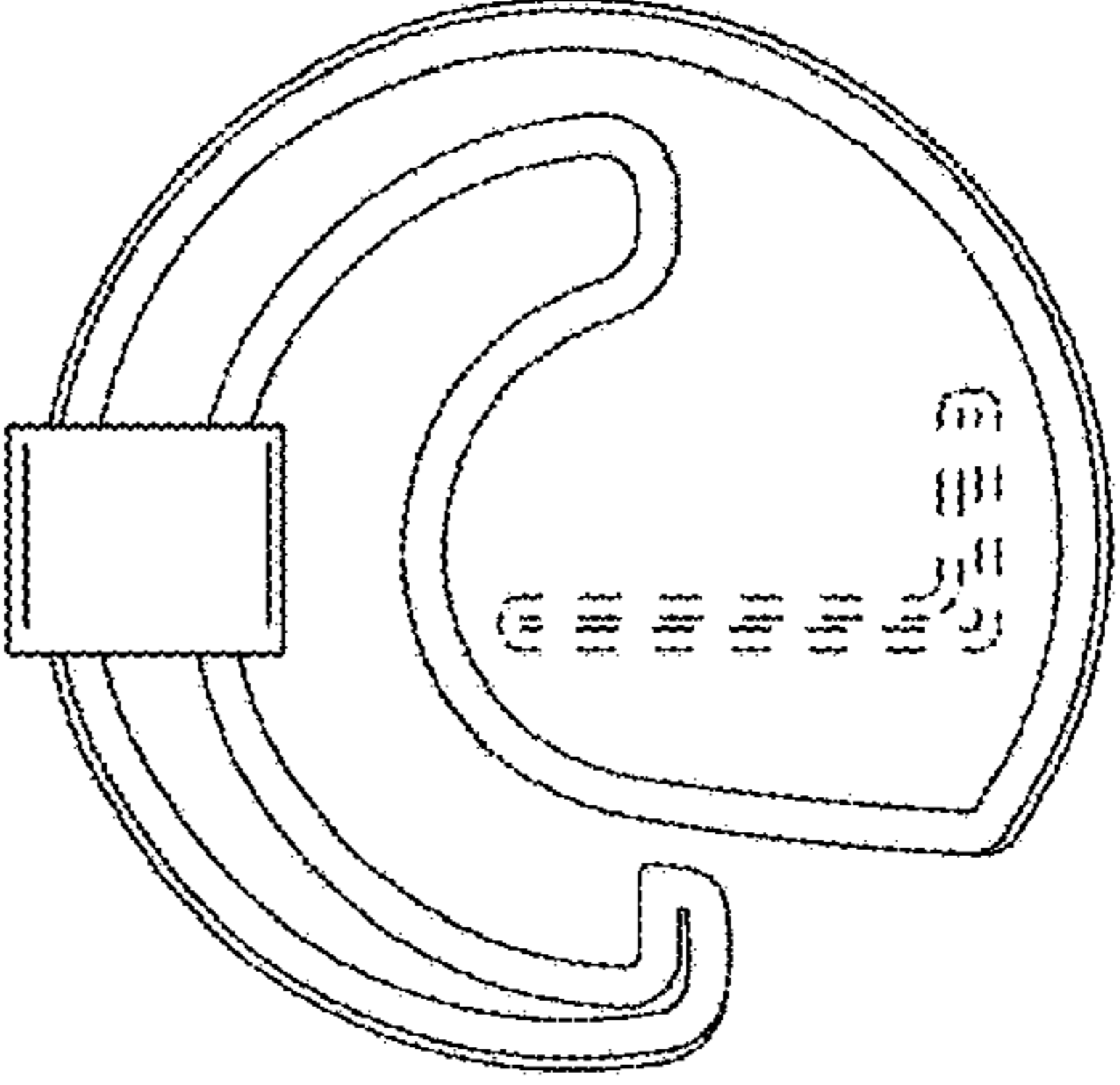

Fig. 4

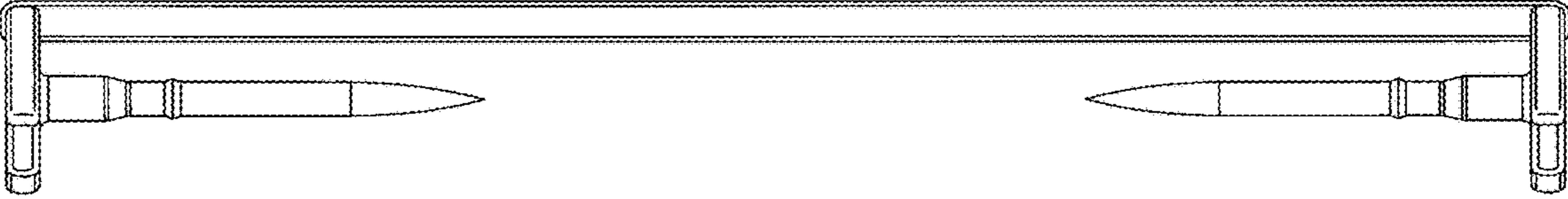

Fig. 5

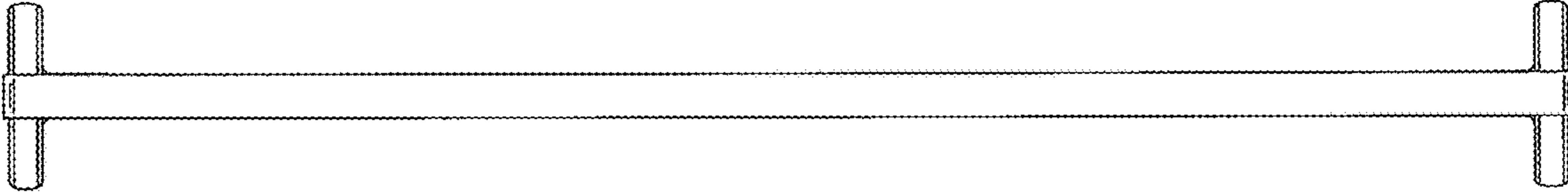

Fig. 6

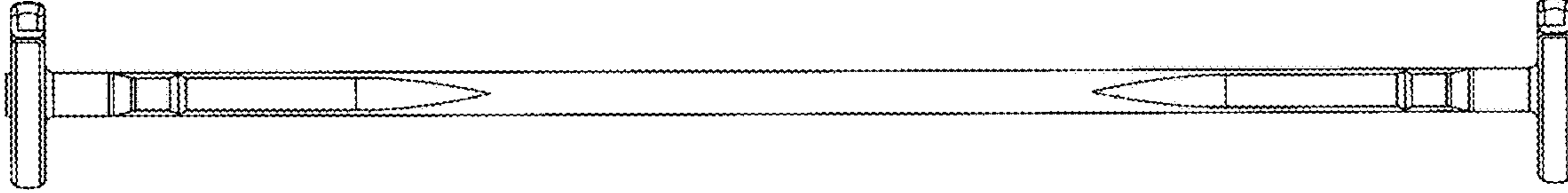

Fig. 7

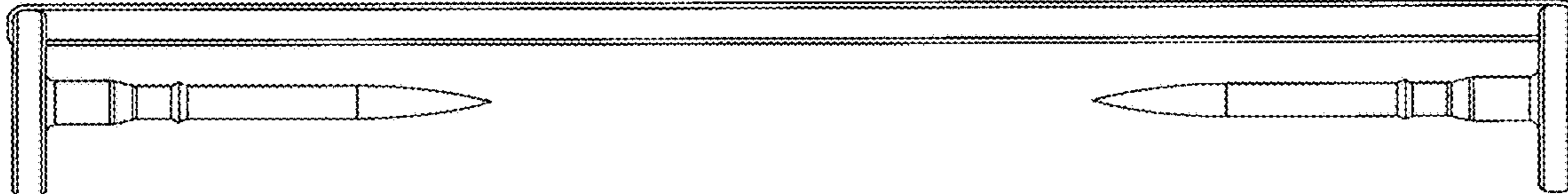

Fig. 8

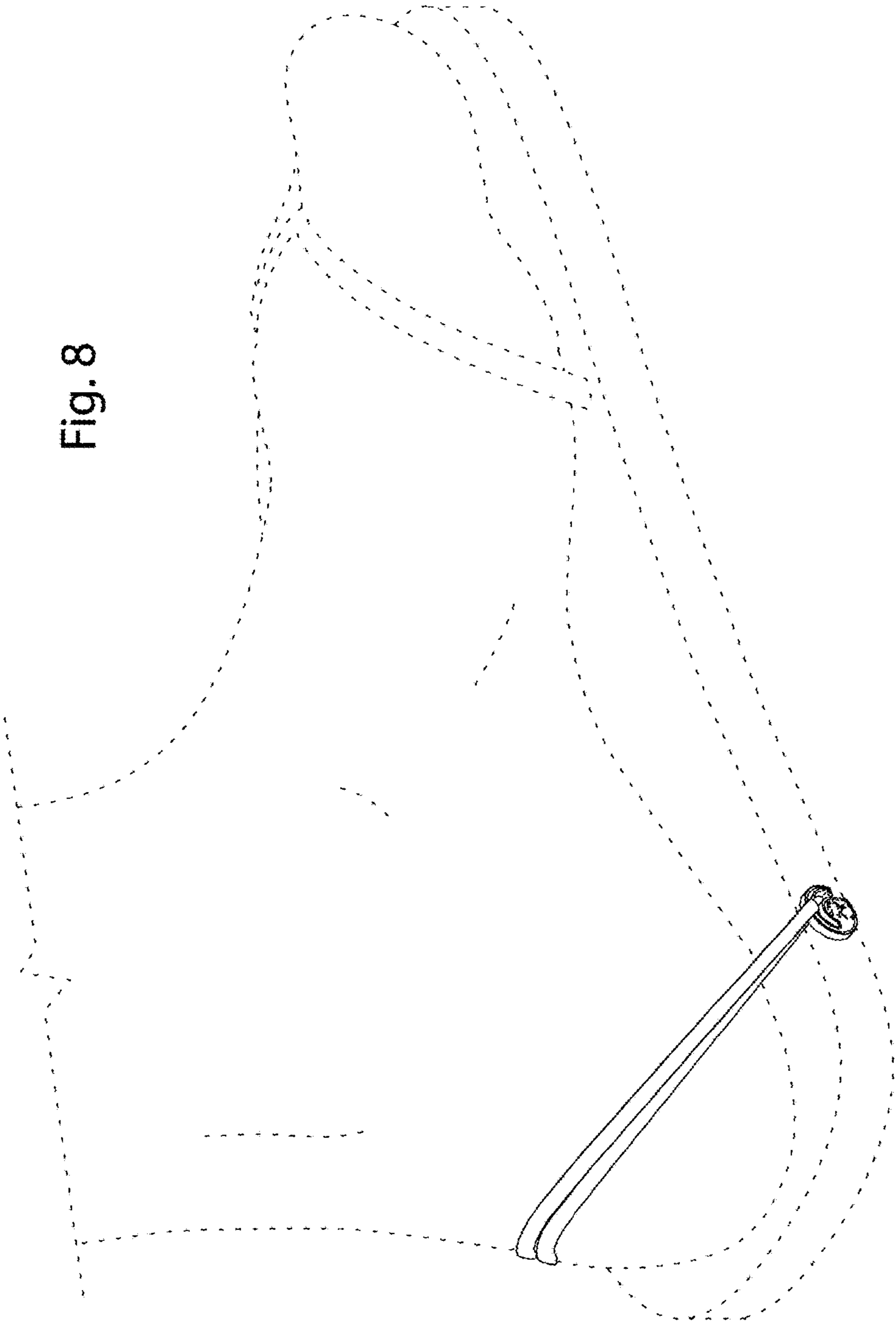

Fig. 9

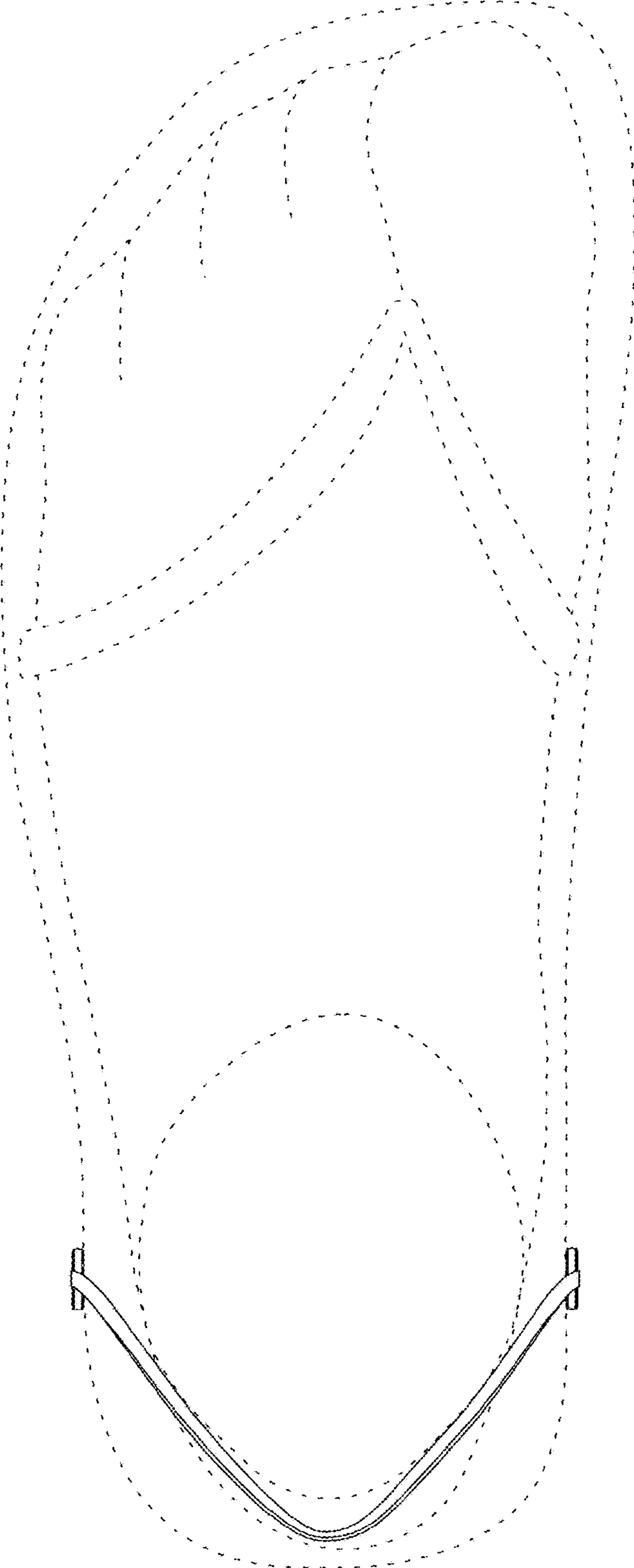
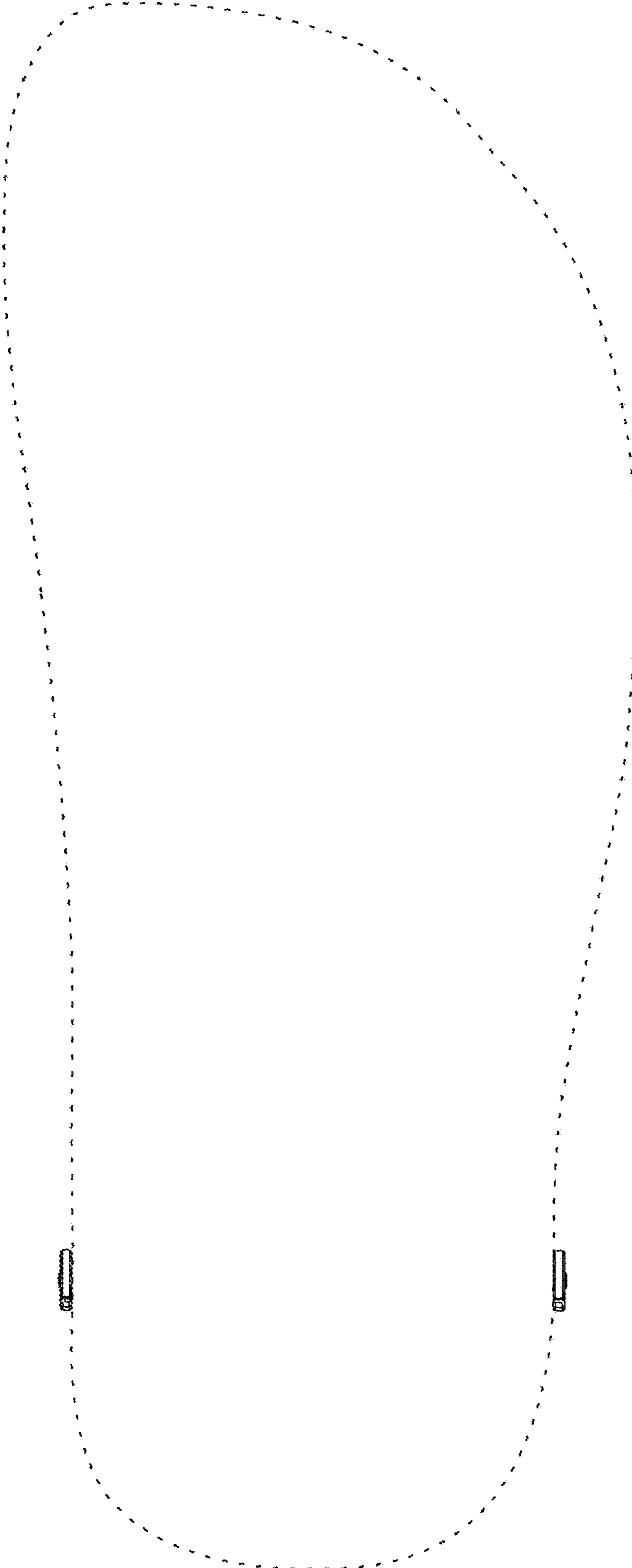

Fig. 10



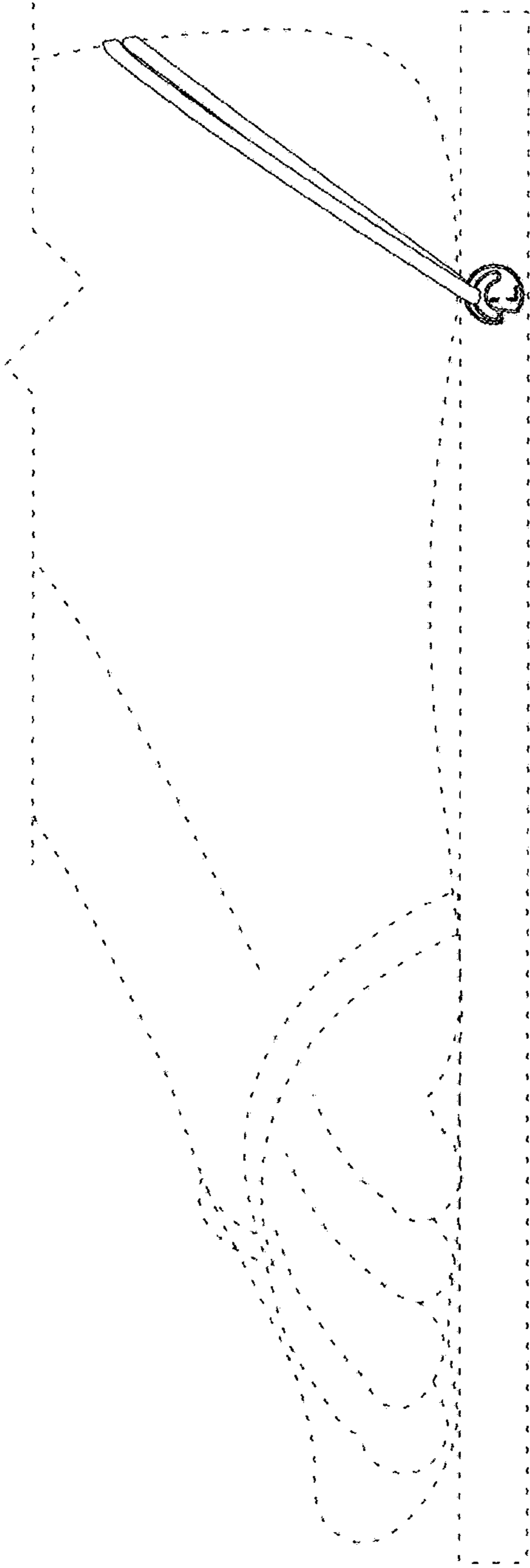

Fig. 11

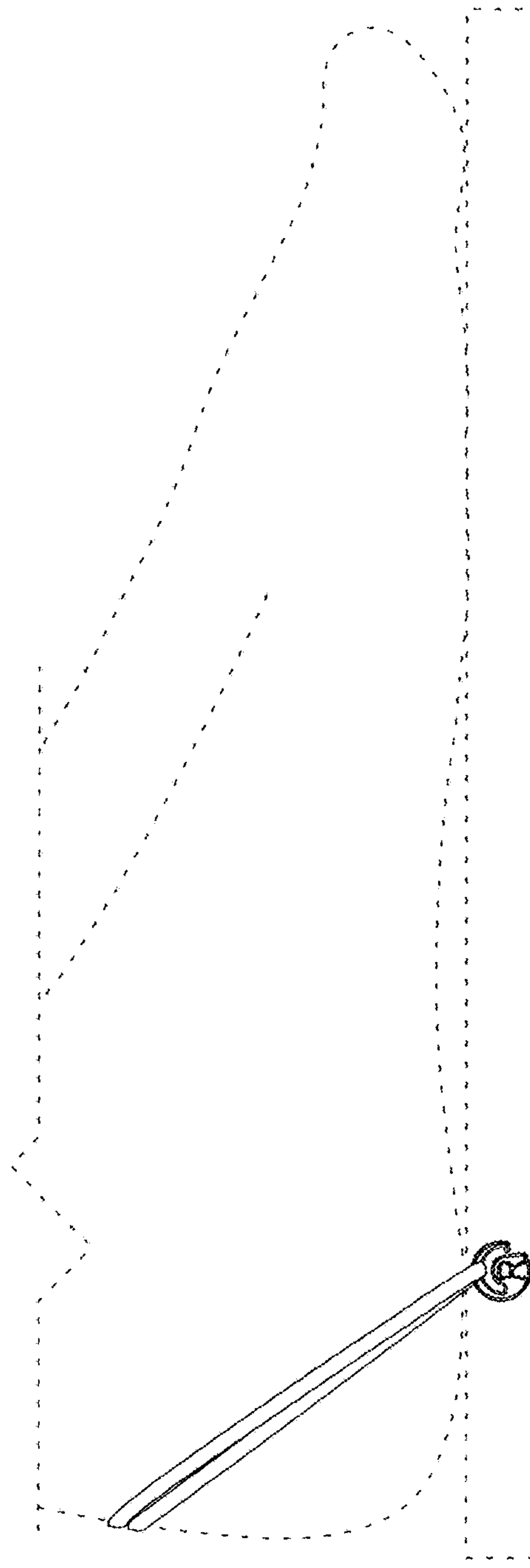

Fig. 12

Fig. 13

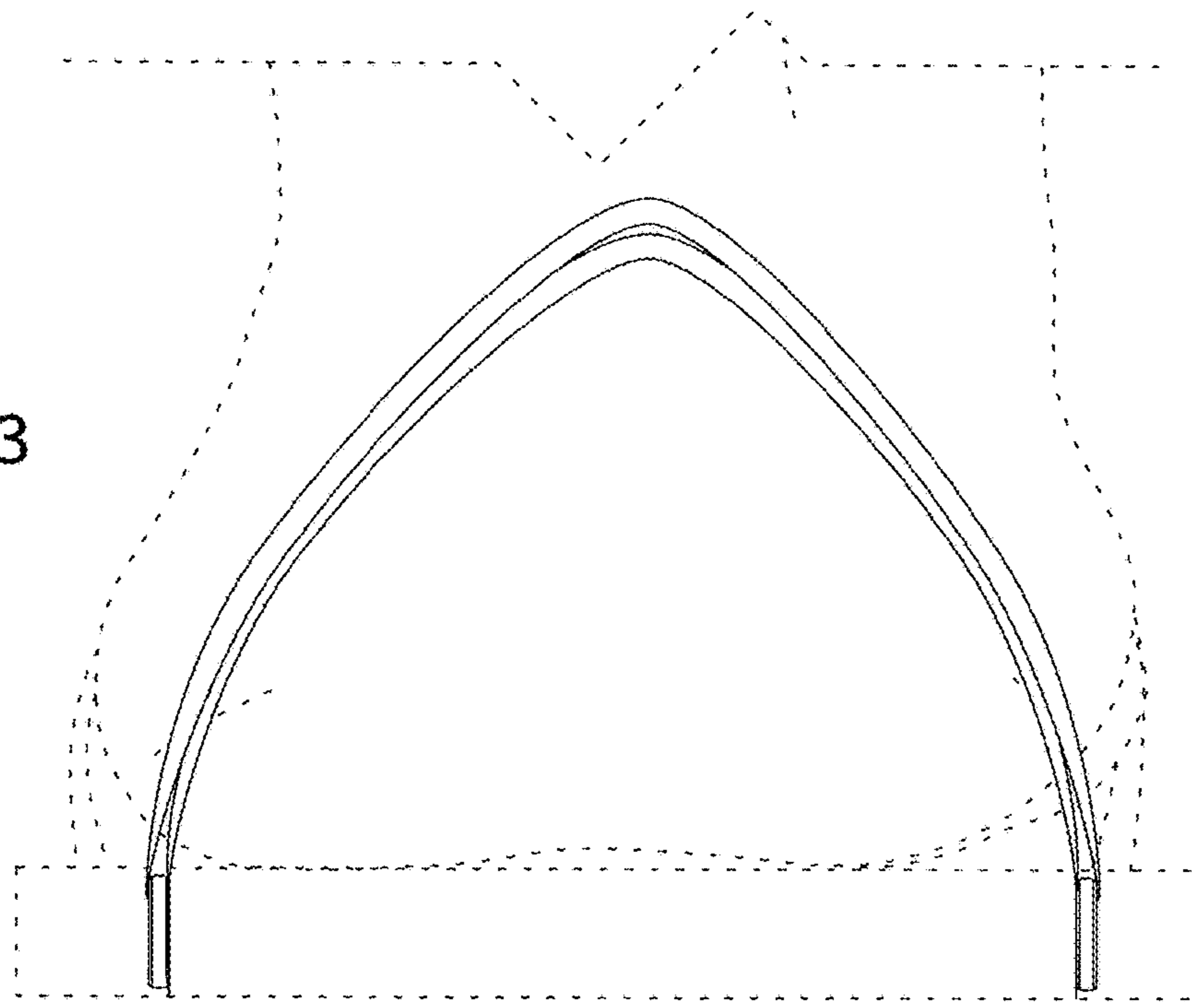

Fig. 14

