



US00D838433S

(12) **United States Design Patent**
Florek

(10) **Patent No.:** **US D838,433 S**

(45) **Date of Patent:** **** Jan. 22, 2019**

(54) **SHIRT**

(71) Applicant: **Woolmed Sp.z.o.o.**, Nowy Sacz (PL)

(72) Inventor: **Ryszard Florek**, Labowa (PL)

(73) Assignee: **Woolmed Sp z.o.o.**, Nowy Sacz (PL)

(**) Term: **15 Years**

(21) Appl. No.: **29/591,932**

(22) Filed: **Jan. 25, 2017**

(51) **LOC (11) Cl.** **02-02**

(52) **U.S. Cl.**
USPC **D2/717**

(58) **Field of Classification Search**
USPC D2/712, 713, 731, 734, 737, 738, 742,
D2/743, 831, 840, 851, 857
CPC A41D 1/04; A41D 27/10; A41D 13/00;
A41D 13/088; A41D 13/0015
See application file for complete search history.

(56) **References Cited**

U.S. PATENT DOCUMENTS

D619,782 S *	7/2010	Rhodes	D2/717
D620,228 S *	7/2010	Jones	D2/717
D627,134 S *	11/2010	Rhodes	D2/700
D628,771 S *	12/2010	Kanada	D2/717
D655,478 S *	3/2012	McCollum	D2/829
D721,872 S *	2/2015	Cooper	D2/840
D732,271 S *	6/2015	Fischer	D2/731

D755,472 S *	5/2016	Bhunoo	D2/717
D758,701 S *	6/2016	Chiang	D2/840
D764,764 S *	8/2016	Campbell	D2/840
D771,904 S	11/2016	McArthur et al.		
D778,536 S *	2/2017	Adrovic	D2/731
D795,535 S *	8/2017	Azoulay	D2/840
D798,545 S *	10/2017	Lomax	D2/828
D808,613 S *	1/2018	Moseri	D2/717
2005/0112976 A1 *	5/2005	McMurray	D04B 21/04
2011/0296580 A1 *	12/2011	Demarest	A41D 27/28 2/69

* cited by examiner

Primary Examiner — R. Johnson

(74) *Attorney, Agent, or Firm* — Grossman, Tucker,
Perreault & Pfleger, PLLC

(57) **CLAIM**

The ornamental design for a shirt, as shown and described.

DESCRIPTION

FIG. 1 is a perspective view of a shirt of the present invention;

FIG. 2 is a front view of the shirt of FIG. 1;

FIG. 3 is a back view of the shirt of FIG. 1;

FIG. 4 is a side view of the shirt of FIG. 1; and,

FIG. 5 is a top view of the shirt of FIG. 1.

The stippled shading represents a contrast in appearance.

1 Claim, 5 Drawing Sheets

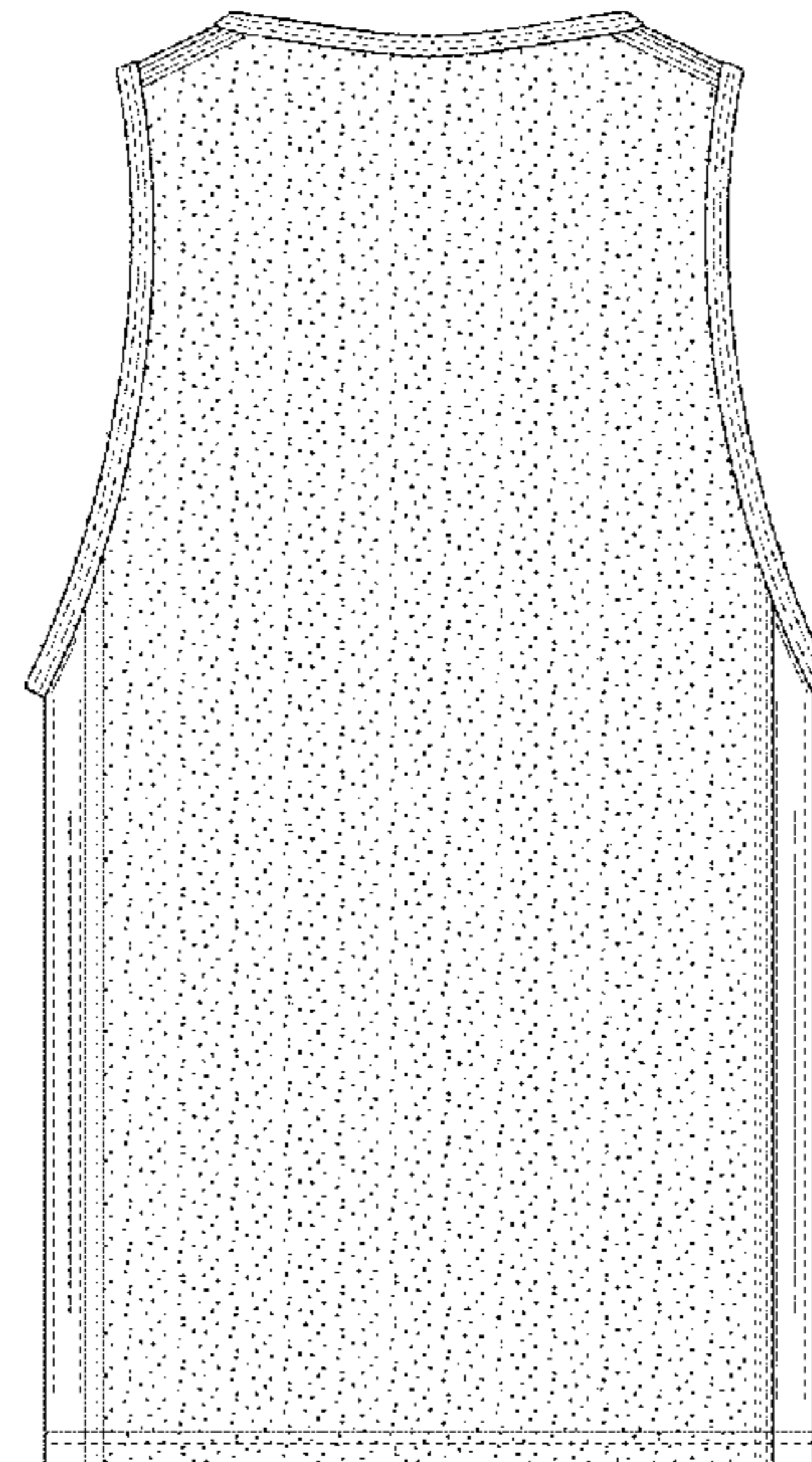
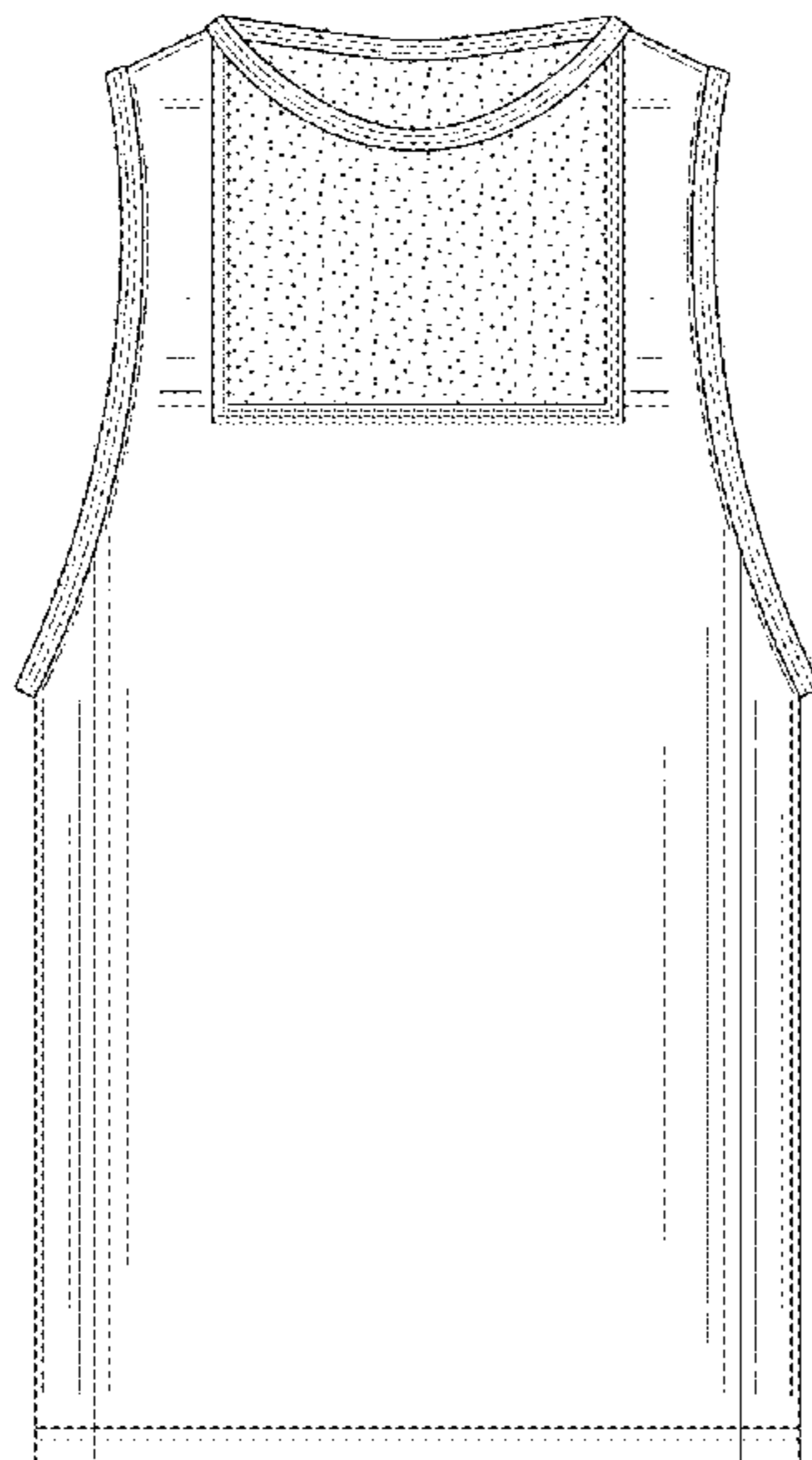

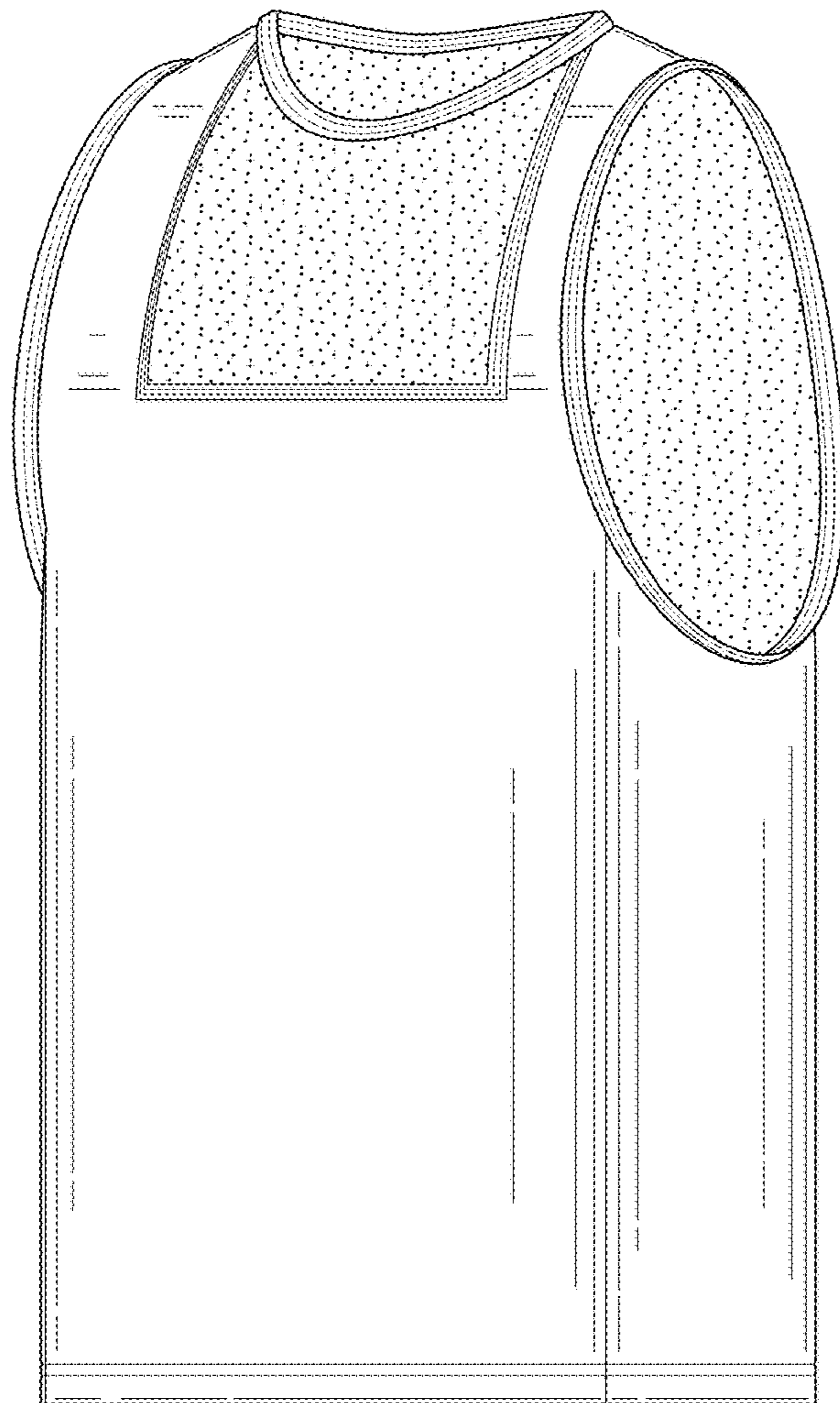

FIG. 1

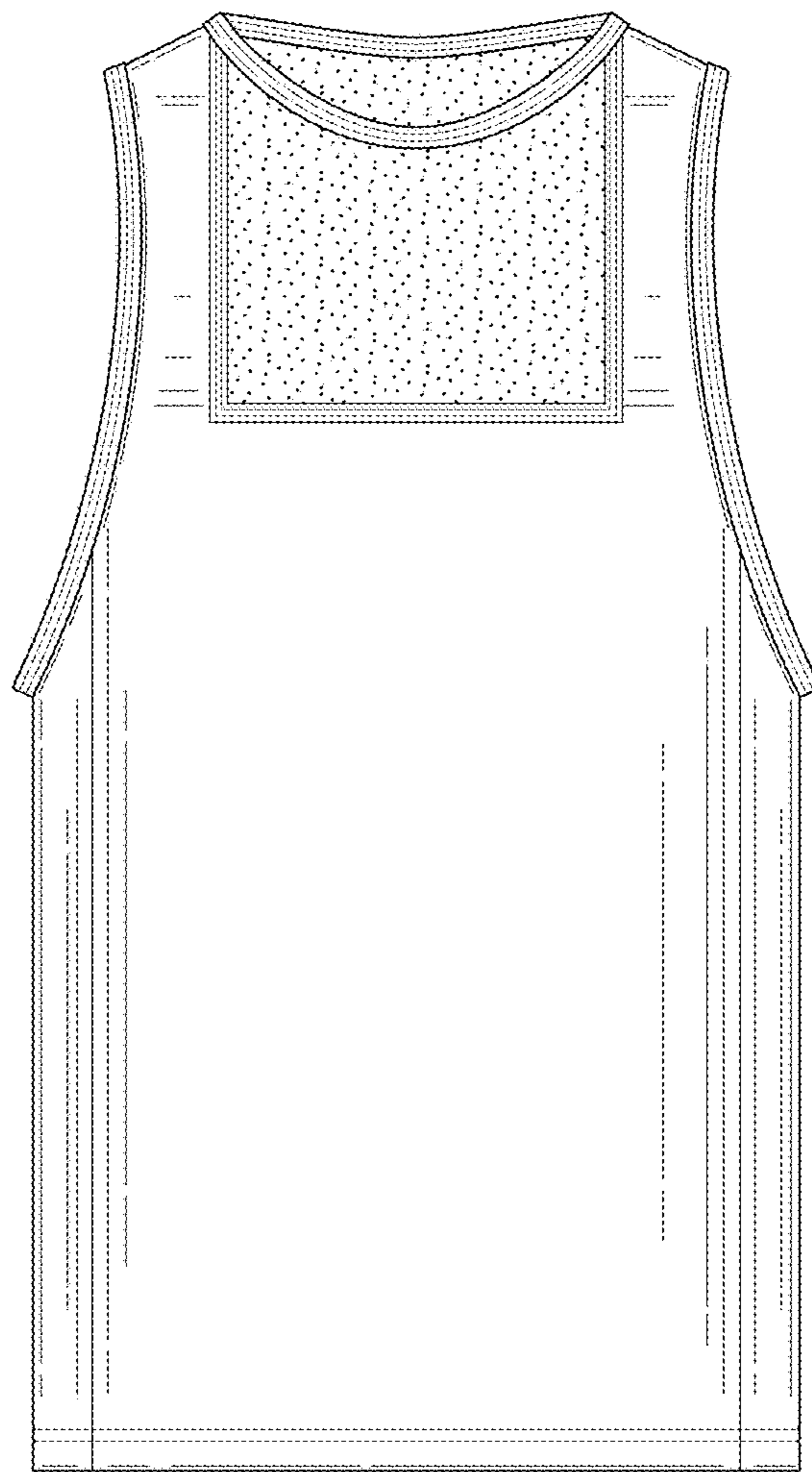

FIG. 2

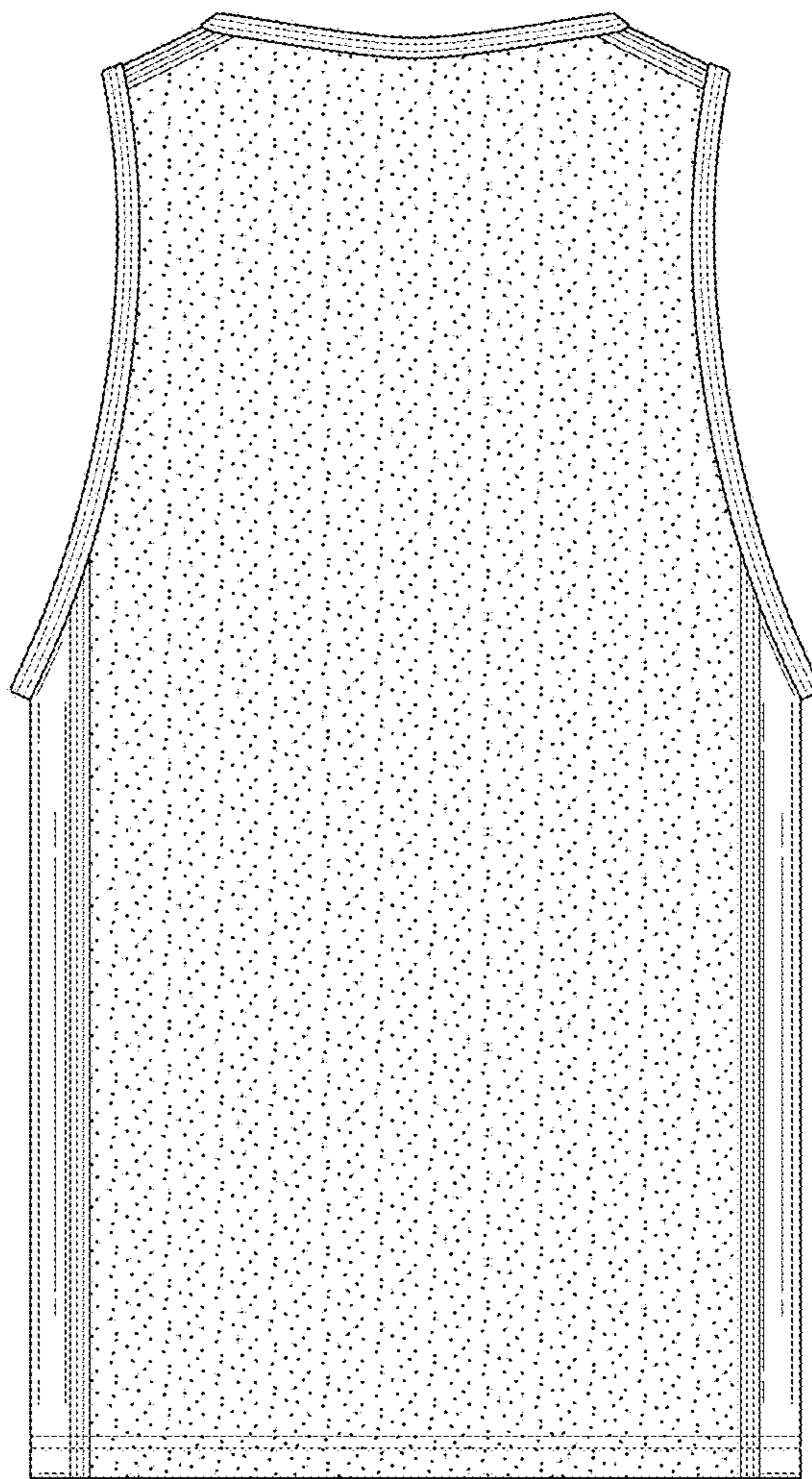

FIG. 3

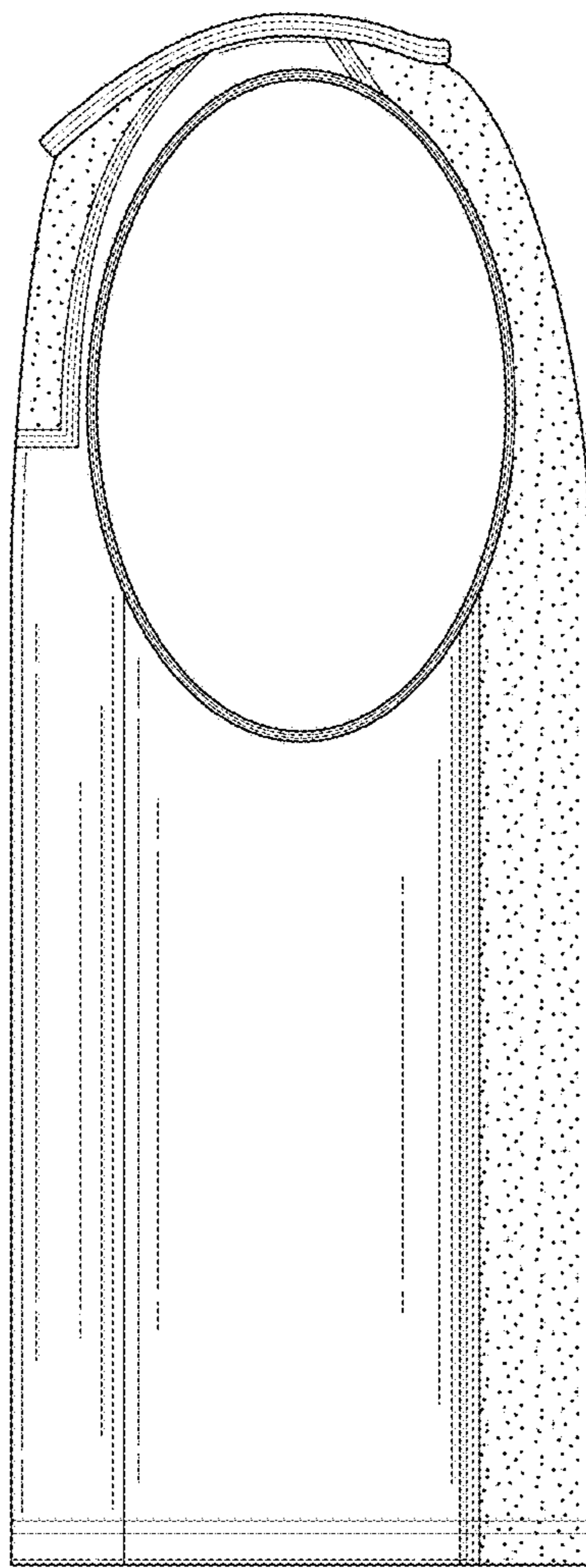

FIG. 4

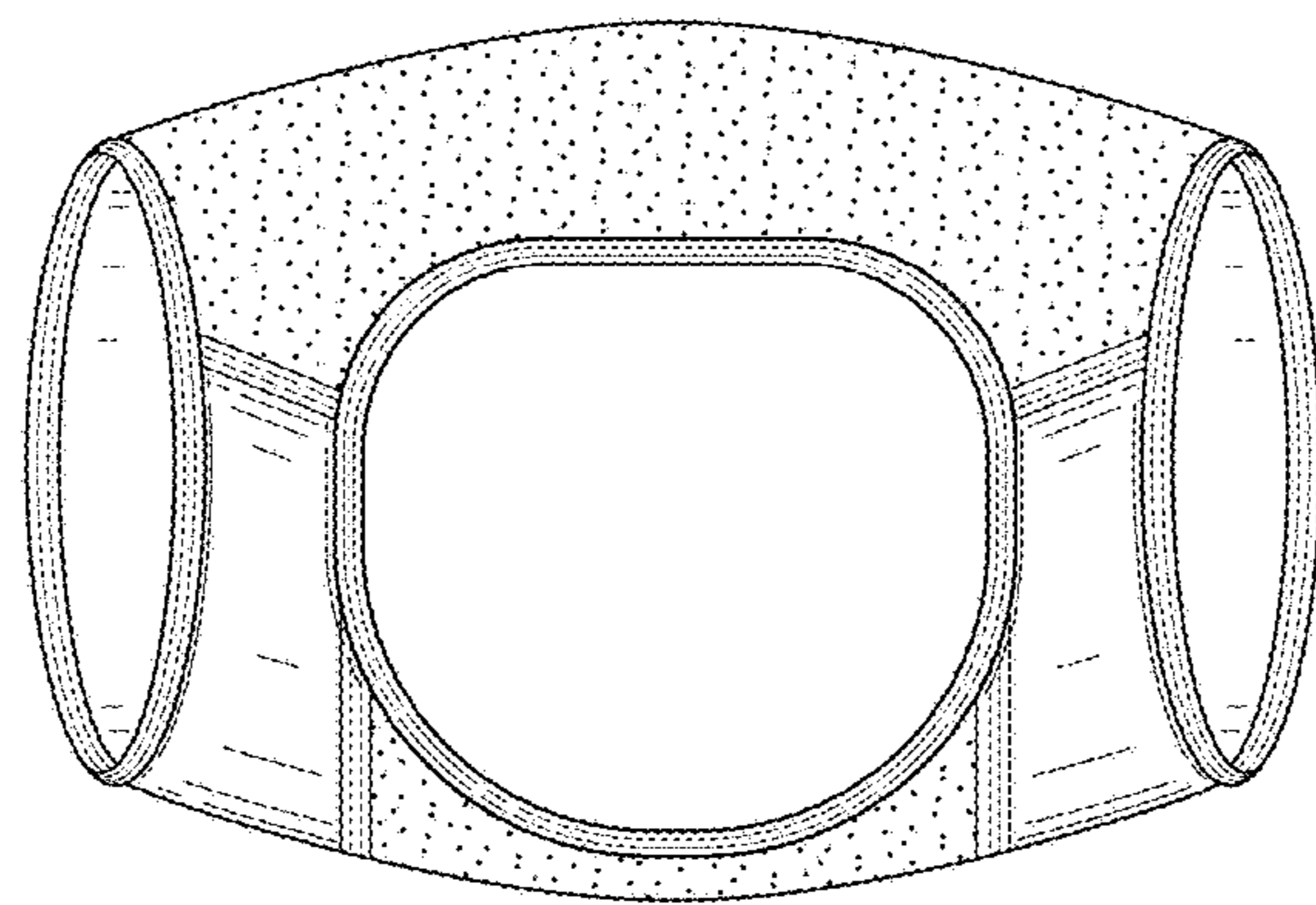

FIG. 5

UNITED STATES PATENT AND TRADEMARK OFFICE
CERTIFICATE OF CORRECTION

PATENT NO. : D838,433 S
APPLICATION NO. : 29/591932
DATED : January 22, 2019
INVENTOR(S) : Ryszard Florek

Page 1 of 7

It is certified that error appears in the above-identified patent and that said Letters Patent is hereby corrected as shown below:

On the Title Page

Please replace the title page with corrected illustrative figures.

In the Drawings

Please replace FIGS. 1 through 5 with the attached FIGS. 1 through 5.

Signed and Sealed this
Twenty-fifth Day of June, 2019

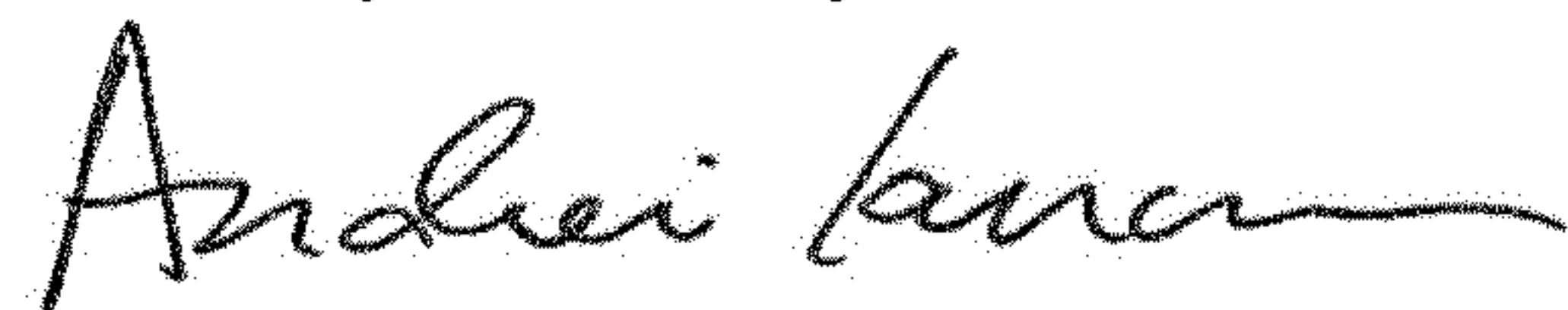

Andrei Iancu
Director of the United States Patent and Trademark Office

(12) **United States Design Patent** (10) **Patent No.:** **US D838,433 S**
Florek (45) **Date of Patent:** **** Jan. 22, 2019**

(54) **SHIRT**
 (71) Applicant: **Woolmed Sp.z.o.o., Nowy Sacz (PL)**
 (72) Inventor: **Ryszard Florek, Labowa (PL)**
 (73) Assignee: **Woolmed Sp z.o.o., Nowy Sacz (PL)**
 (**) Term: **15 Years**
 (21) Appl. No.: **29/591,932**
 (22) Filed: **Jan. 25, 2017**
 (51) **LOC (11) Cl.** **02-02**
 (52) **U.S. Cl.**
 USPC **D2/717**
 (58) **Field of Classification Search**
 USPC D2/712, 713, 731, 734, 737, 738, 742,
 D2/743, 831, 840, 851, 857
 CPC A41D 1/04; A41D 27/10; A41D 13/00;
 A41D 13/088; A41D 13/0015
 See application file for complete search history.

D755,472 S * 5/2016 Bhunnoo D2/717
 D758,701 S * 6/2016 Chiang D2/840
 D764,764 S * 8/2016 Campbell D2/840
 D771,904 S 11/2016 McArthur et al.
 D778,536 S * 2/2017 Adrovic D2/731
 D795,535 S * 8/2017 Azoulay D2/840
 D798,545 S * 10/2017 Lomax D2/828
 D808,613 S * 1/2018 Moseri D2/717
 2005/0112976 A1* 5/2005 McMurray D04B 21/04
 2011/0296580 A1* 12/2011 Demarest A41D 27/28
 2/69

* cited by examiner

Primary Examiner — R. Johnson
 (74) *Attorney, Agent, or Firm* — Grossman, Tucker,
 Perreault & Pflieger, PLLC

(57) **CLAIM**

The ornamental design for a shirt, as shown and described.

DESCRIPTION

FIG. 1 is a perspective view of a shirt of the present invention;
 FIG. 2 is a front view of the shirt of FIG. 1;
 FIG. 3 is a back view of the shirt of FIG. 1;
 FIG. 4 is a side view of the shirt of FIG. 1; and,
 FIG. 5 is a top view of the shirt of FIG. 1.
 The stippled shading represents a contrast in appearance.

1 Claim, 5 Drawing Sheets

(56) **References Cited**
 U.S. PATENT DOCUMENTS
 D619,782 S * 7/2010 Rhodes D2/717
 D620,228 S * 7/2010 Jones D2/717
 D627,134 S * 11/2010 Rhodes D2/700
 D628,771 S * 12/2010 Kanada D2/717
 D655,478 S * 3/2012 McCollum D2/829
 D721,872 S * 2/2015 Cooper D2/840
 D732,271 S * 6/2015 Fischer D2/731

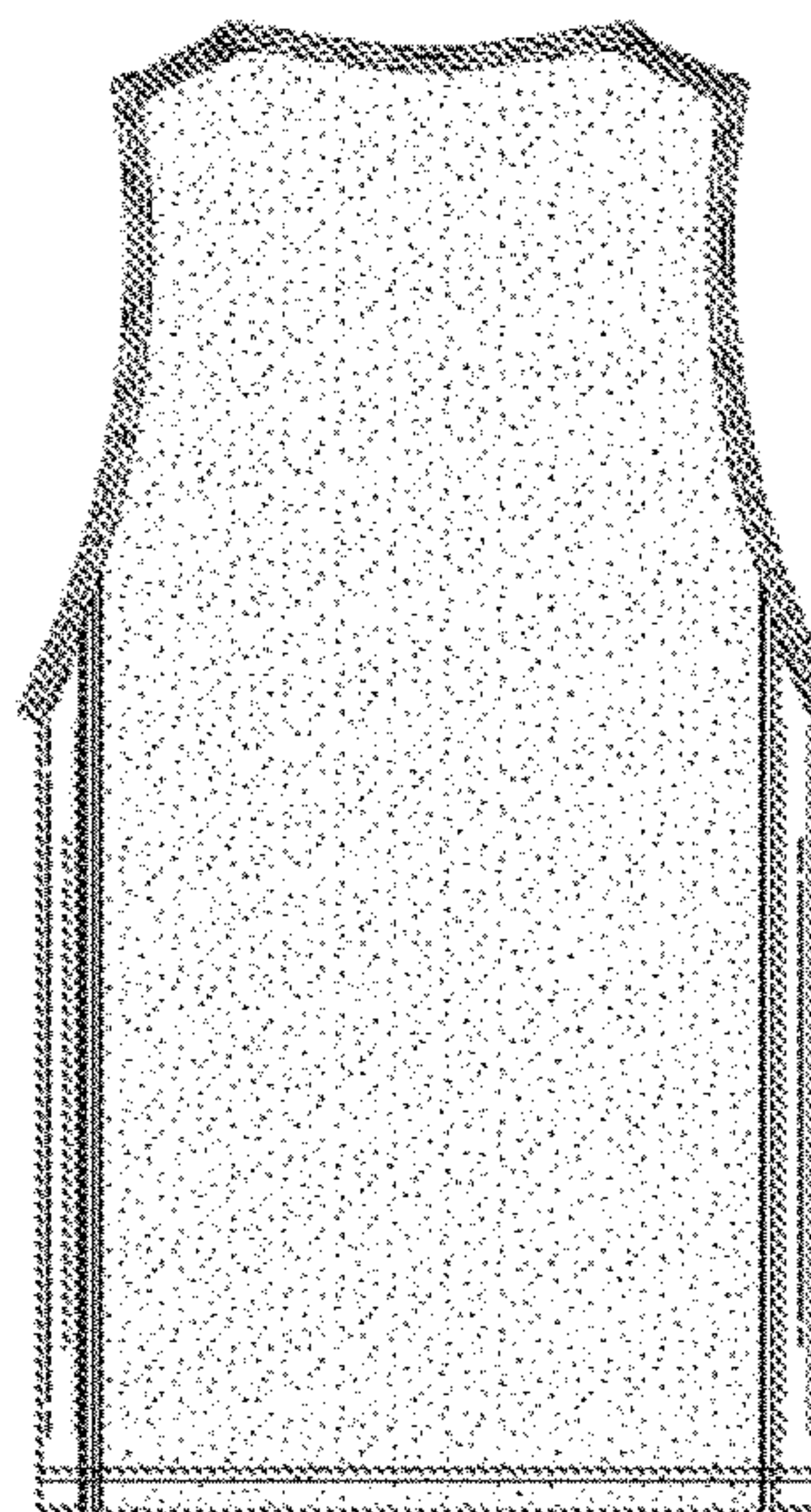
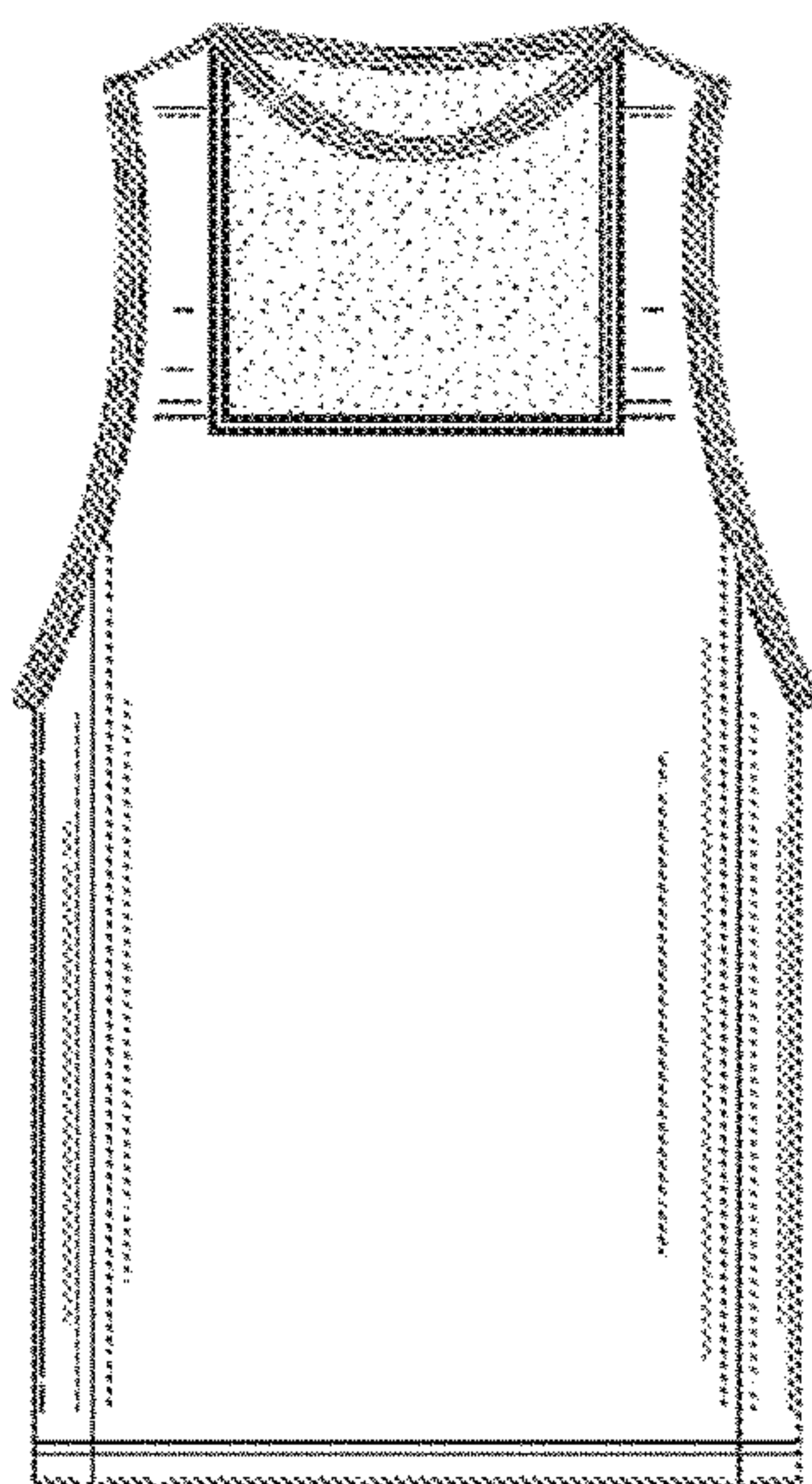

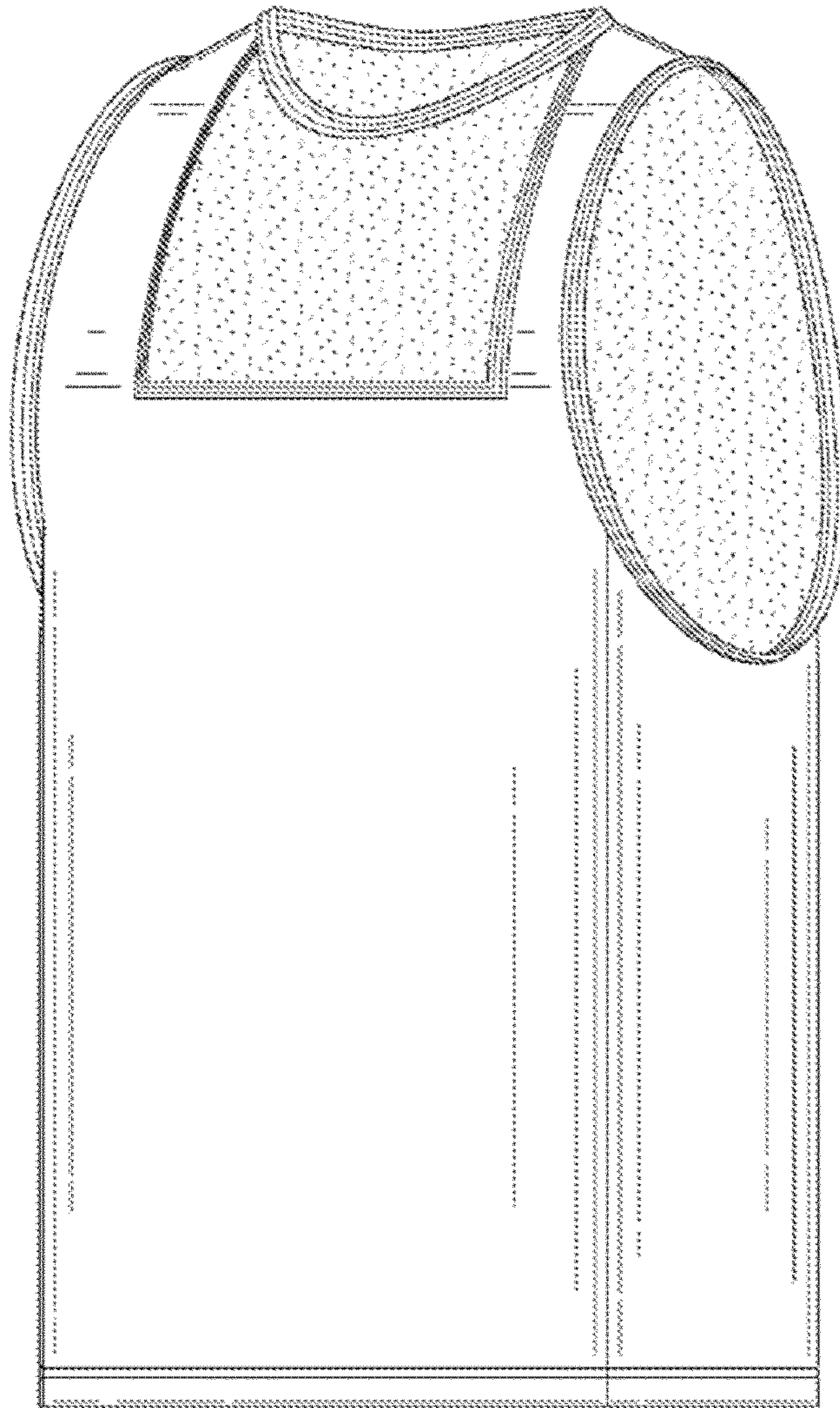

FIG. 1

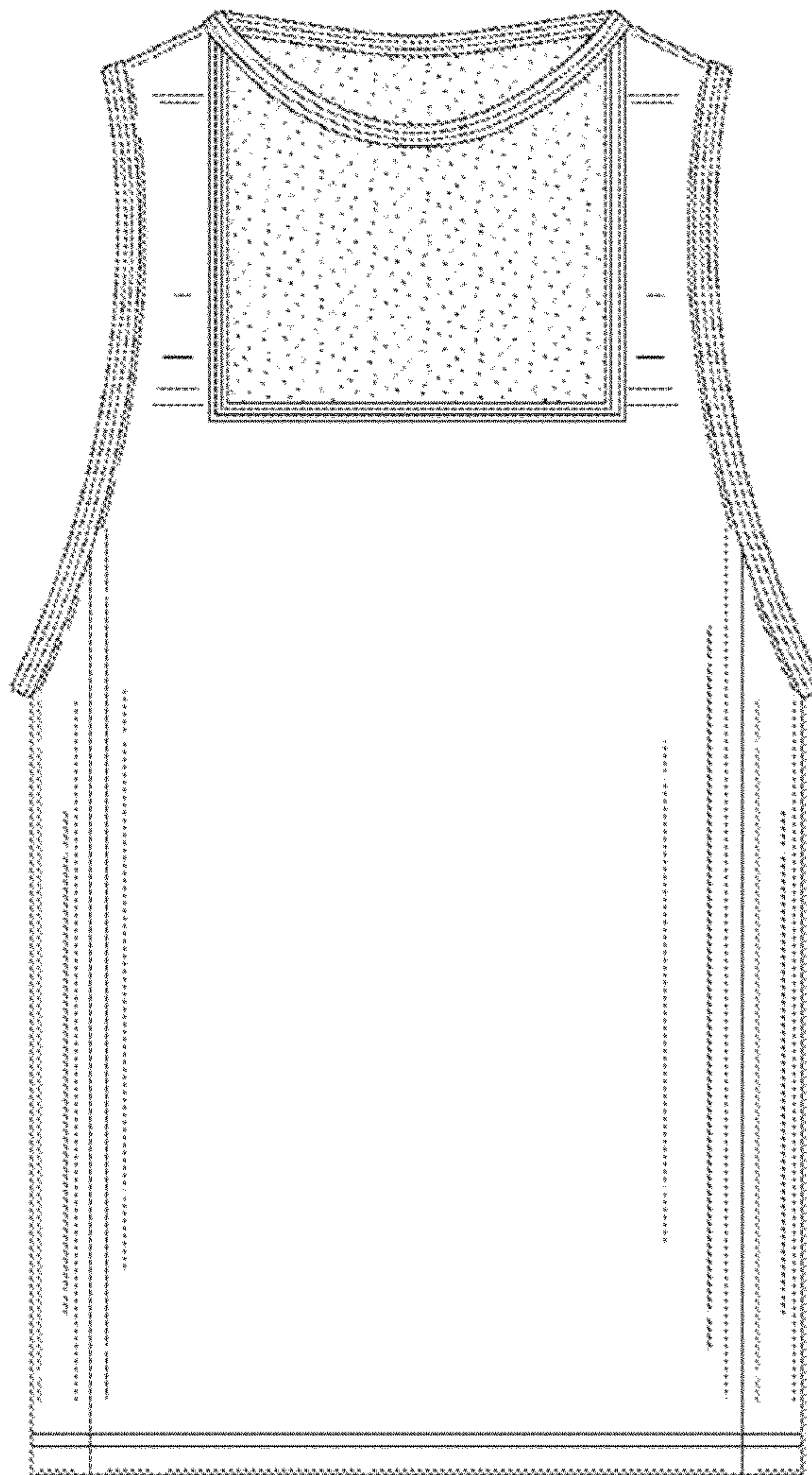

FIG. 2

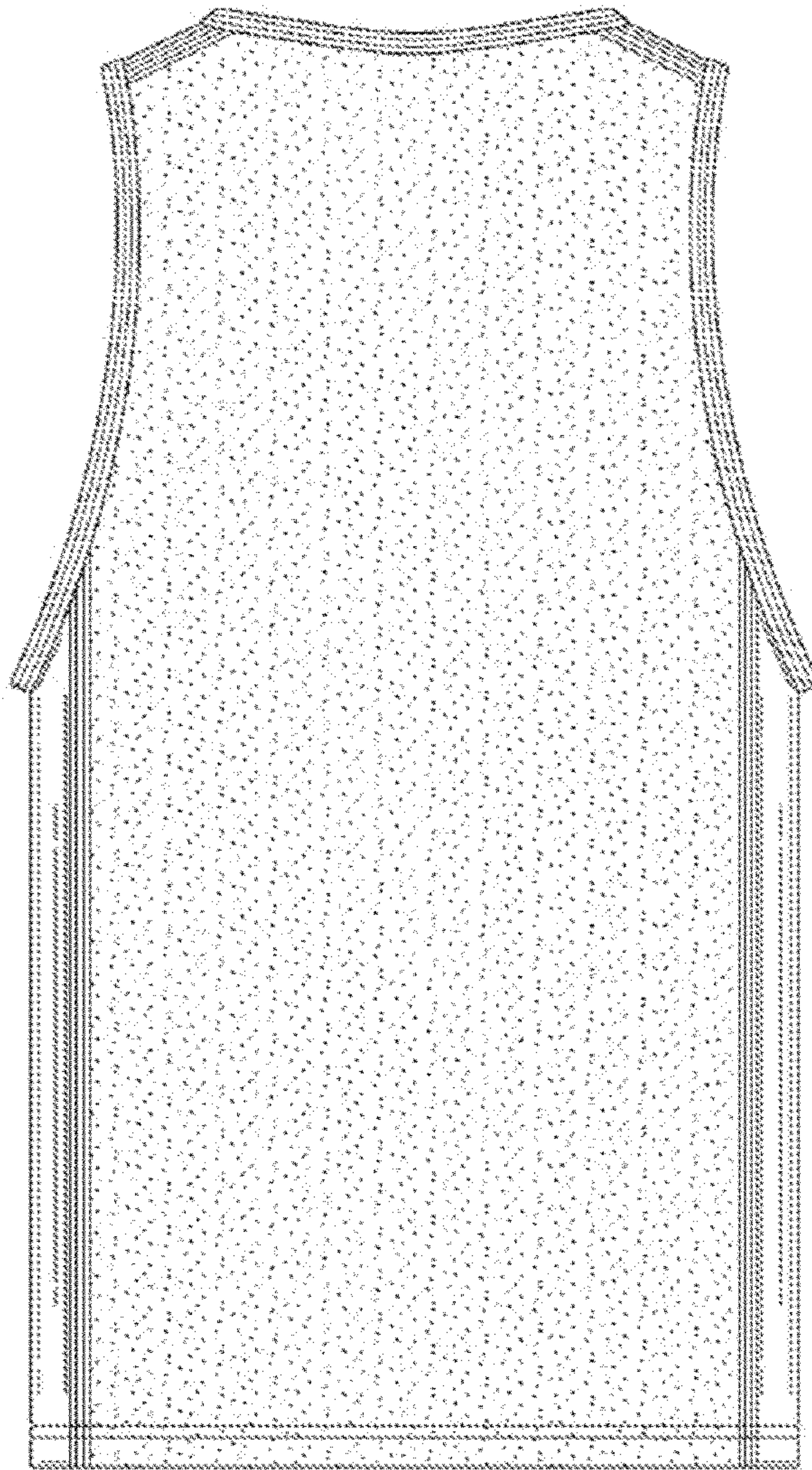

FIG. 3

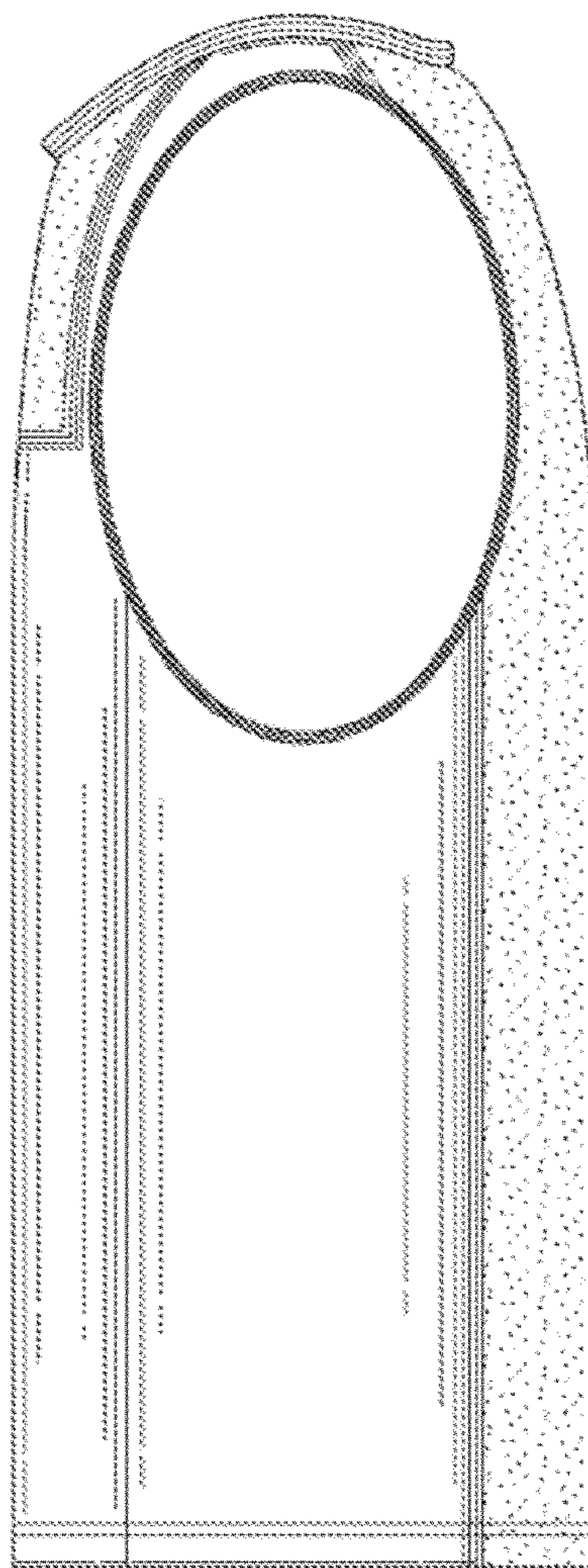

FIG. 4

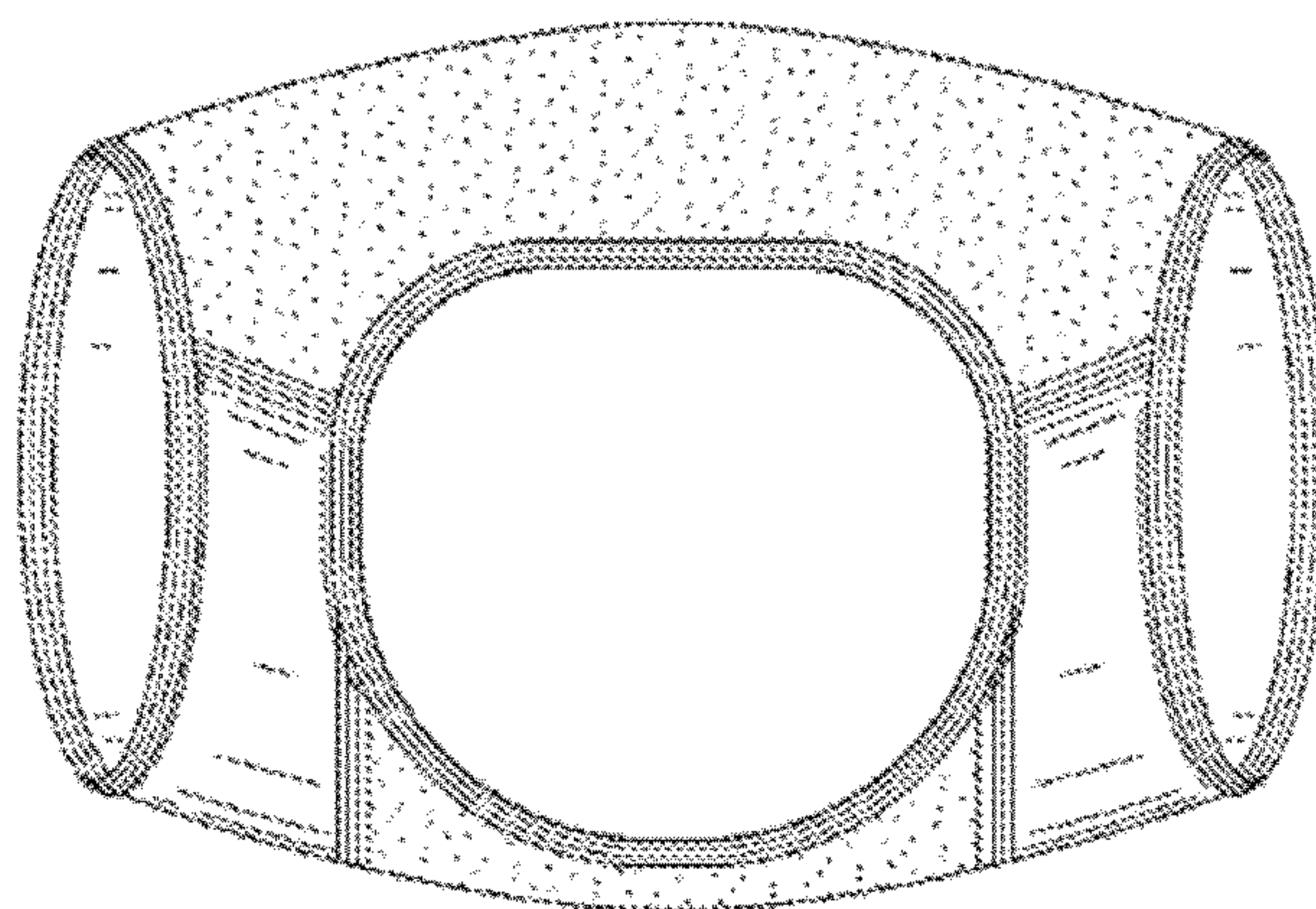

FIG. 5

UNITED STATES PATENT AND TRADEMARK OFFICE
CERTIFICATE OF CORRECTION

PATENT NO. : D838,433 S
APPLICATION NO. : 29/591932
DATED : January 22, 2019
INVENTOR(S) : Ryszard Florek

Page 1 of 7

It is certified that error appears in the above-identified patent and that said Letters Patent is hereby corrected as shown below:

On the Title Page

Please replace the title page with corrected illustrative figures.

In the Drawings

Please replace FIGS. 1 through 5 with the attached FIGS. 1 through 5.

This certificate supersedes the Certificate of Correction issued June 25, 2019.

Signed and Sealed this
Twelfth Day of November, 2019

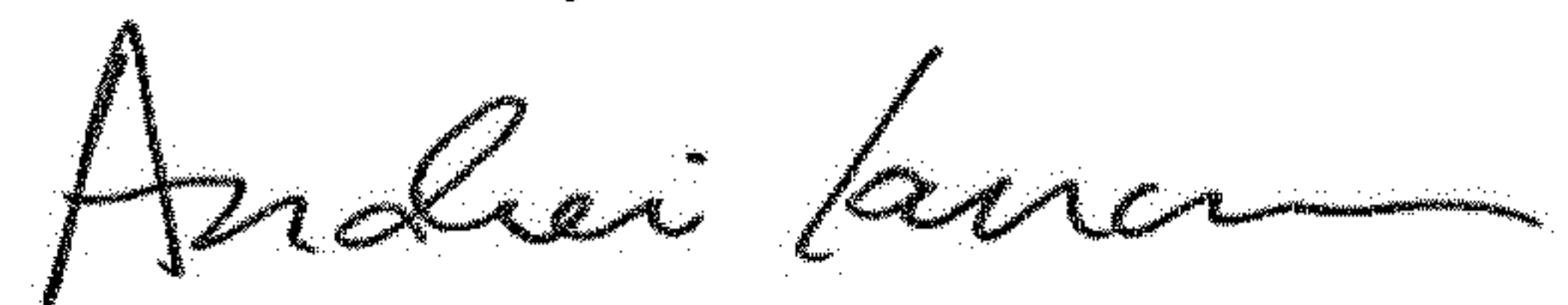

Andrei Iancu
Director of the United States Patent and Trademark Office

(12) **United States Design Patent** (10) **Patent No.:** **US D838,433 S**
Florek (45) **Date of Patent:** **** Jan. 22, 2019**

(54) **SHIRT**
 (71) Applicant: **Woolmed Sp.z.o.o., Nowy Sacz (PL)**
 (72) Inventor: **Ryszard Florek, Labowa (PL)**
 (73) Assignee: **Woolmed Sp z.o.o., Nowy Sacz (PL)**
 (**) Term: **15 Years**
 (21) Appl. No.: **29/591,932**
 (22) Filed: **Jan. 25, 2017**
 (51) **LOC (11) Cl.** **02-02**
 (52) **U.S. Cl.**
 USPC **D2/717**
 (58) **Field of Classification Search**
 USPC D2/712, 713, 731, 734, 737, 738, 742,
 D2/743, 831, 840, 851, 857
 CPC A41D 1/04; A41D 27/10; A41D 13/00;
 A41D 13/088; A41D 13/0015
 See application file for complete search history.

(56) **References Cited**
 U.S. PATENT DOCUMENTS
 D619,782 S * 7/2010 Rhodes D2/717
 D620,228 S * 7/2010 Jones D2/717
 D627,134 S * 11/2010 Rhodes D2/700
 D628,771 S * 12/2010 Kanada D2/717
 D655,478 S * 3/2012 McCollum D2/829
 D721,872 S * 2/2015 Cooper D2/840
 D732,271 S * 6/2015 Fischer D2/731

D755,472 S * 5/2016 Bhunnoo D2/717
 D758,701 S * 6/2016 Chiang D2/840
 D764,764 S * 8/2016 Campbell D2/840
 D771,904 S 11/2016 McArthur et al.
 D778,536 S * 2/2017 Adrovic D2/731
 D795,535 S * 8/2017 Azoulay D2/840
 D798,545 S * 10/2017 Lomax D2/828
 D808,613 S * 1/2018 Moseri D2/717
 2005/0112976 A1 * 5/2005 McMurray D04B 21/04
 2011/0296580 A1 * 12/2011 Demarest A41D 27/28
 2/69

* cited by examiner
 Primary Examiner — R. Johnson
 (74) Attorney, Agent, or Firm — Grossman, Tucker,
 Perreault & Pflieger, PLLC

(57) **CLAIM**
 The ornamental design for a shirt, as shown and described.

DESCRIPTION
 FIG. 1 is a perspective view of a shirt of the present invention;
 FIG. 2 is a front view of the shirt of FIG. 1;
 FIG. 3 is a back view of the shirt of FIG. 1;
 FIG. 4 is a side view of the shirt of FIG. 1; and,
 FIG. 5 is a top view of the shirt of FIG. 1.
 The stippled shading represents a contrast in appearance.

1 Claim, 5 Drawing Sheets

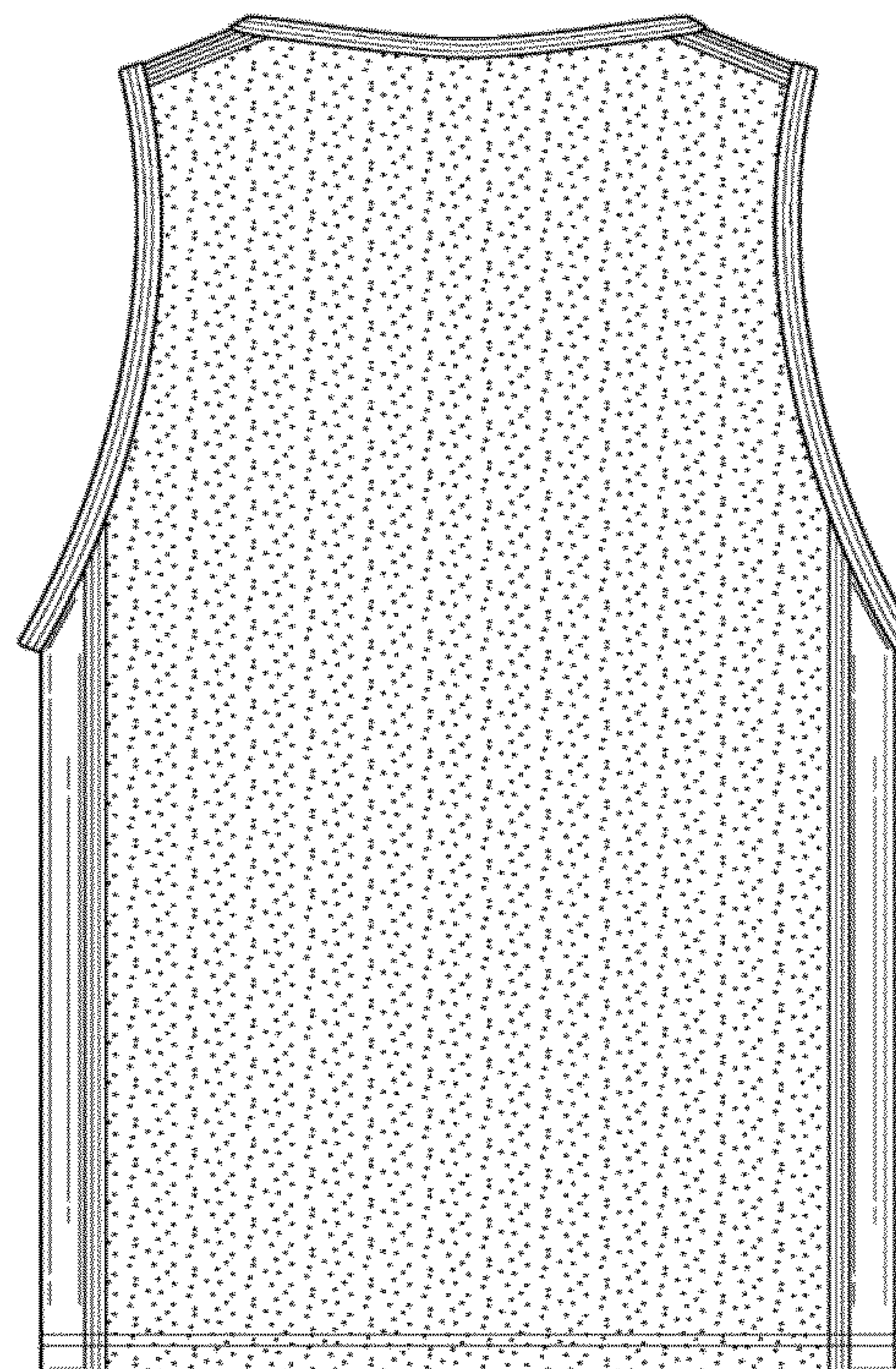
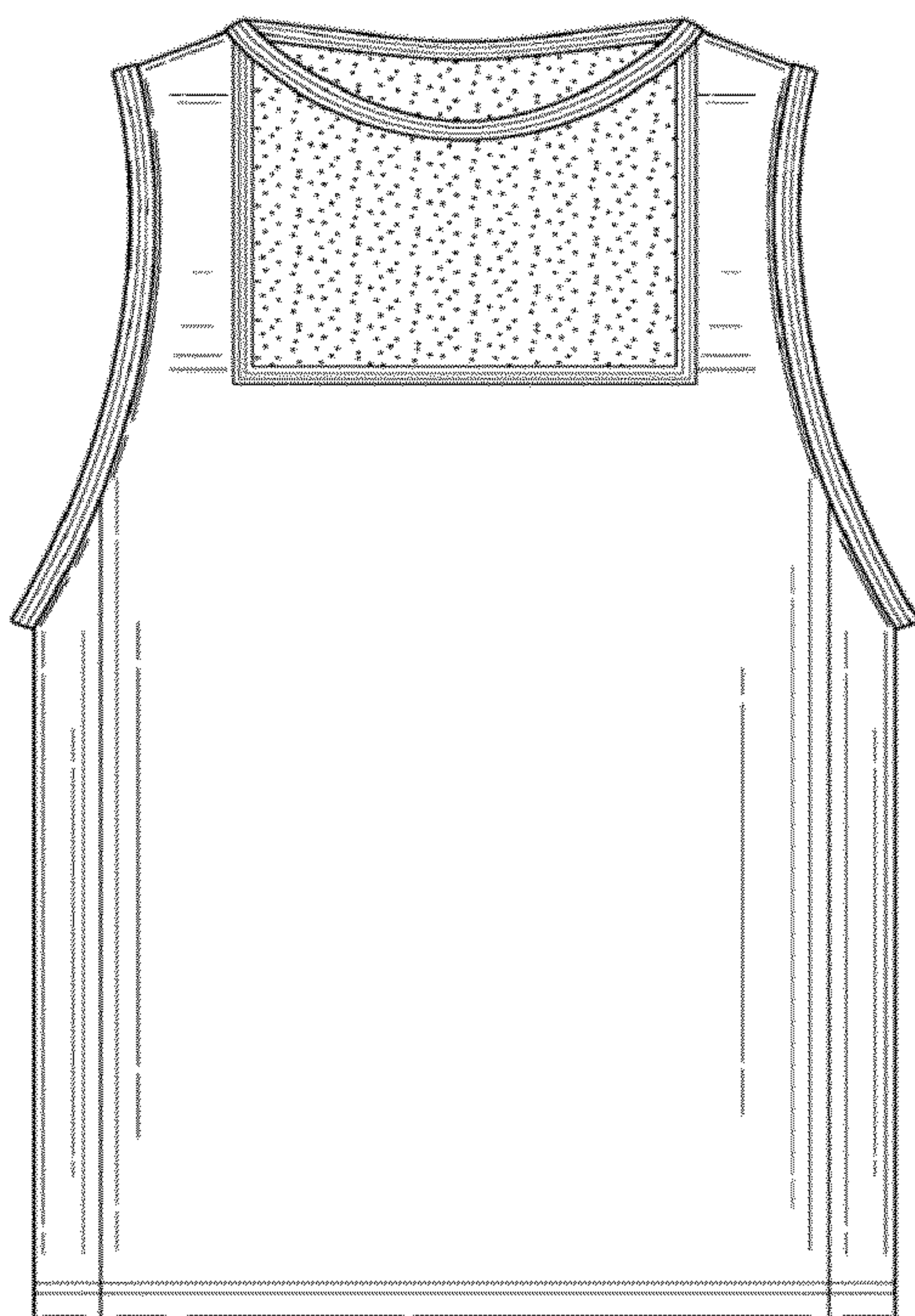

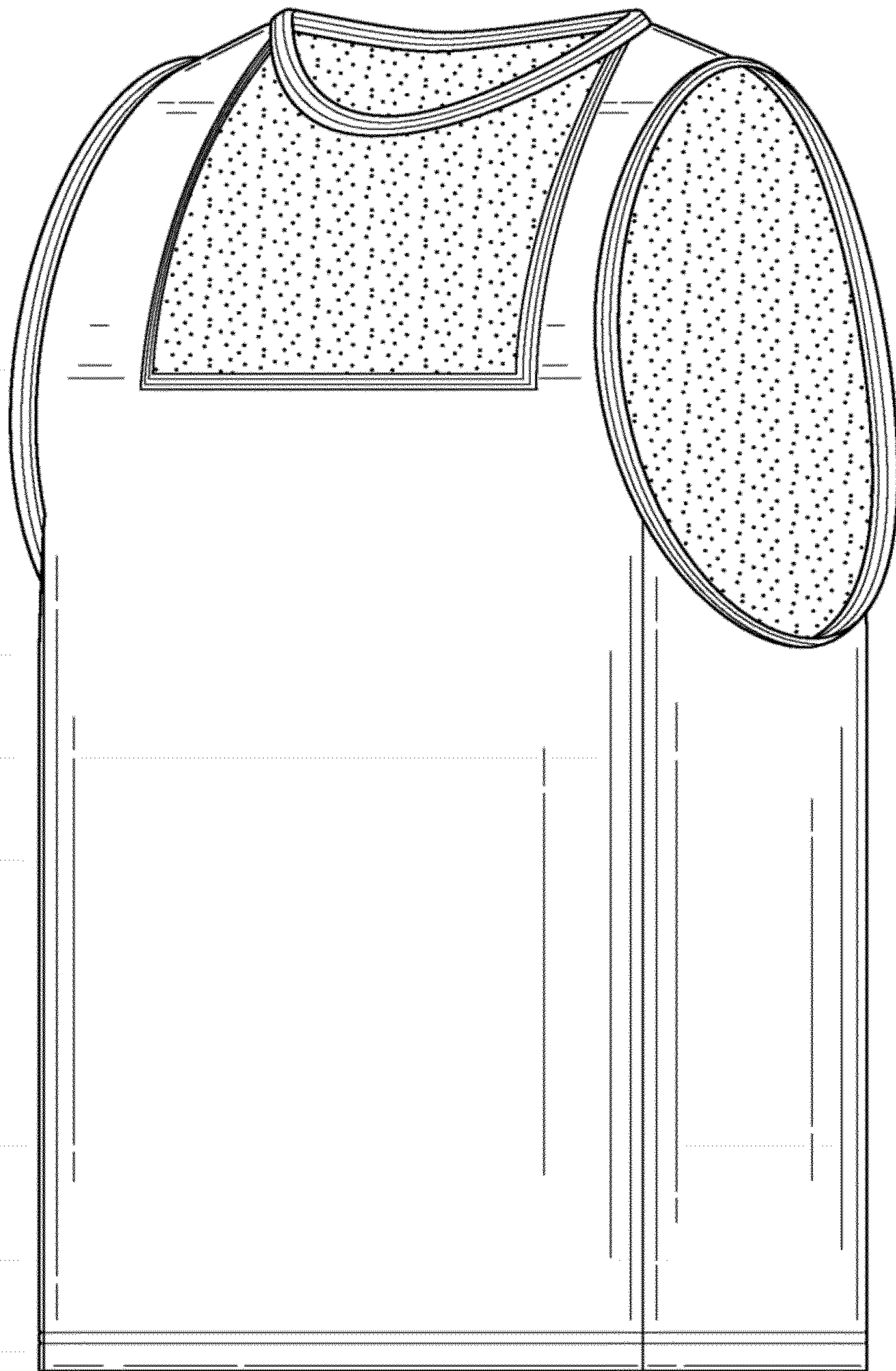

FIG. 1

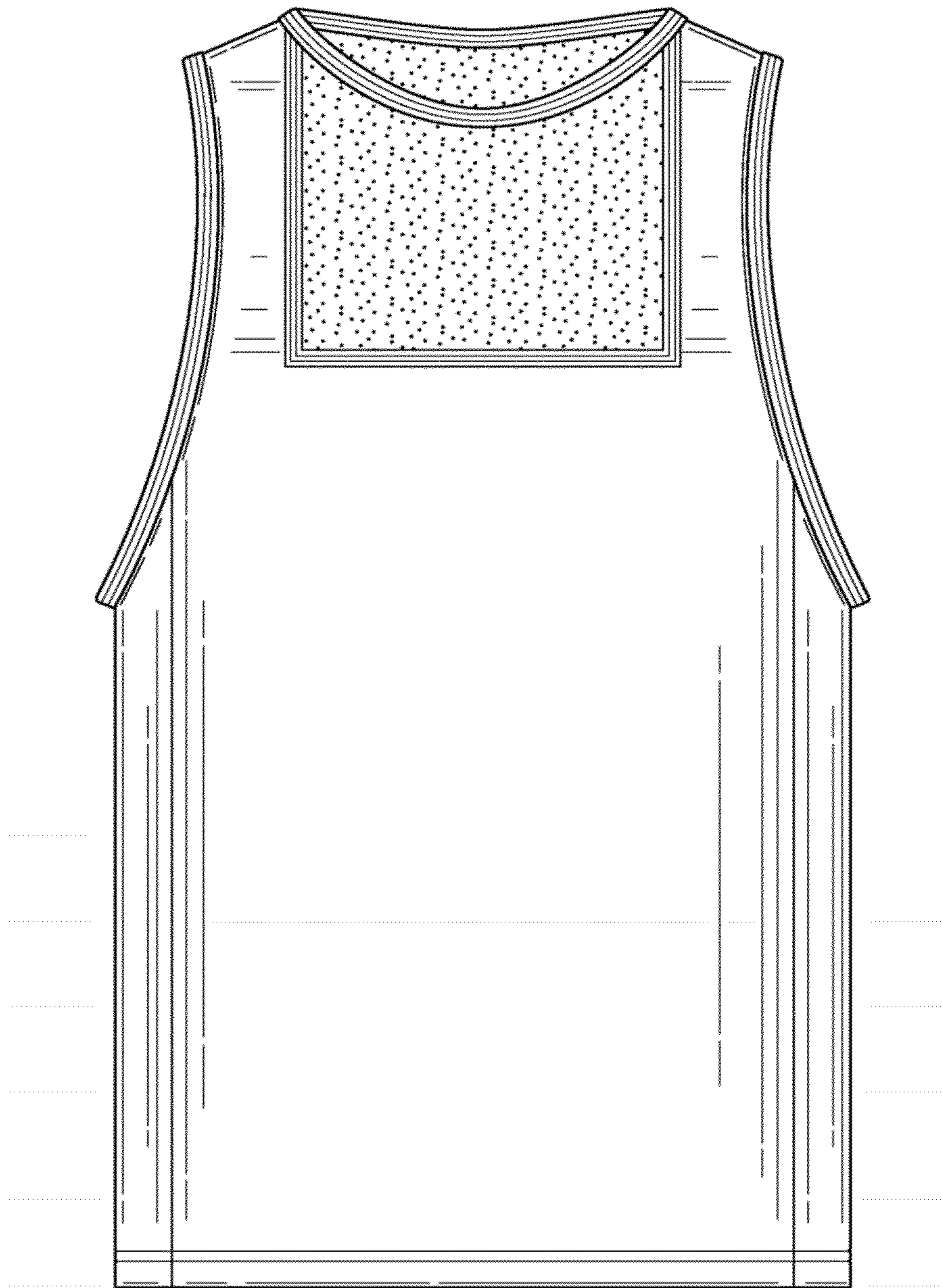

FIG. 2

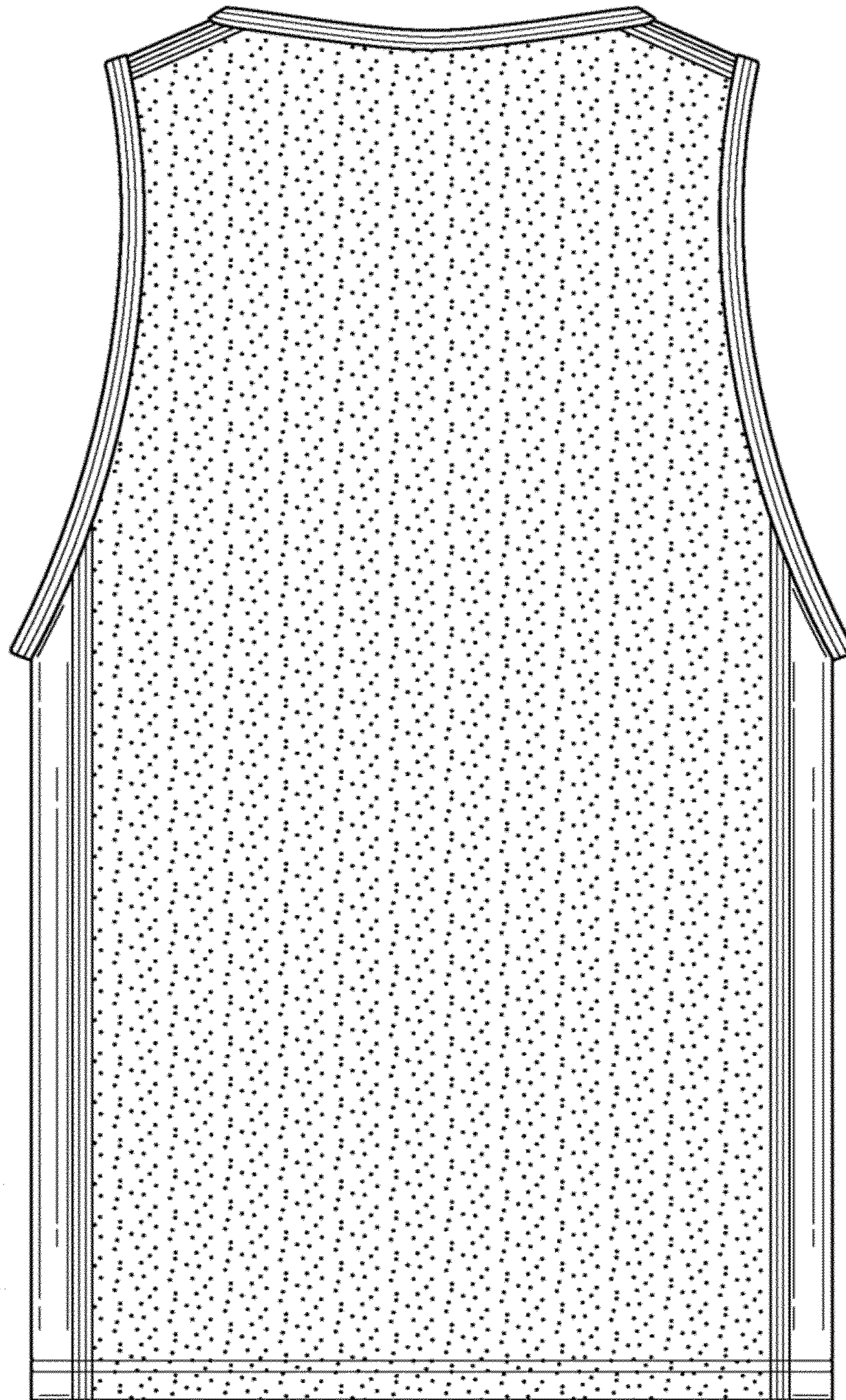

FIG. 3

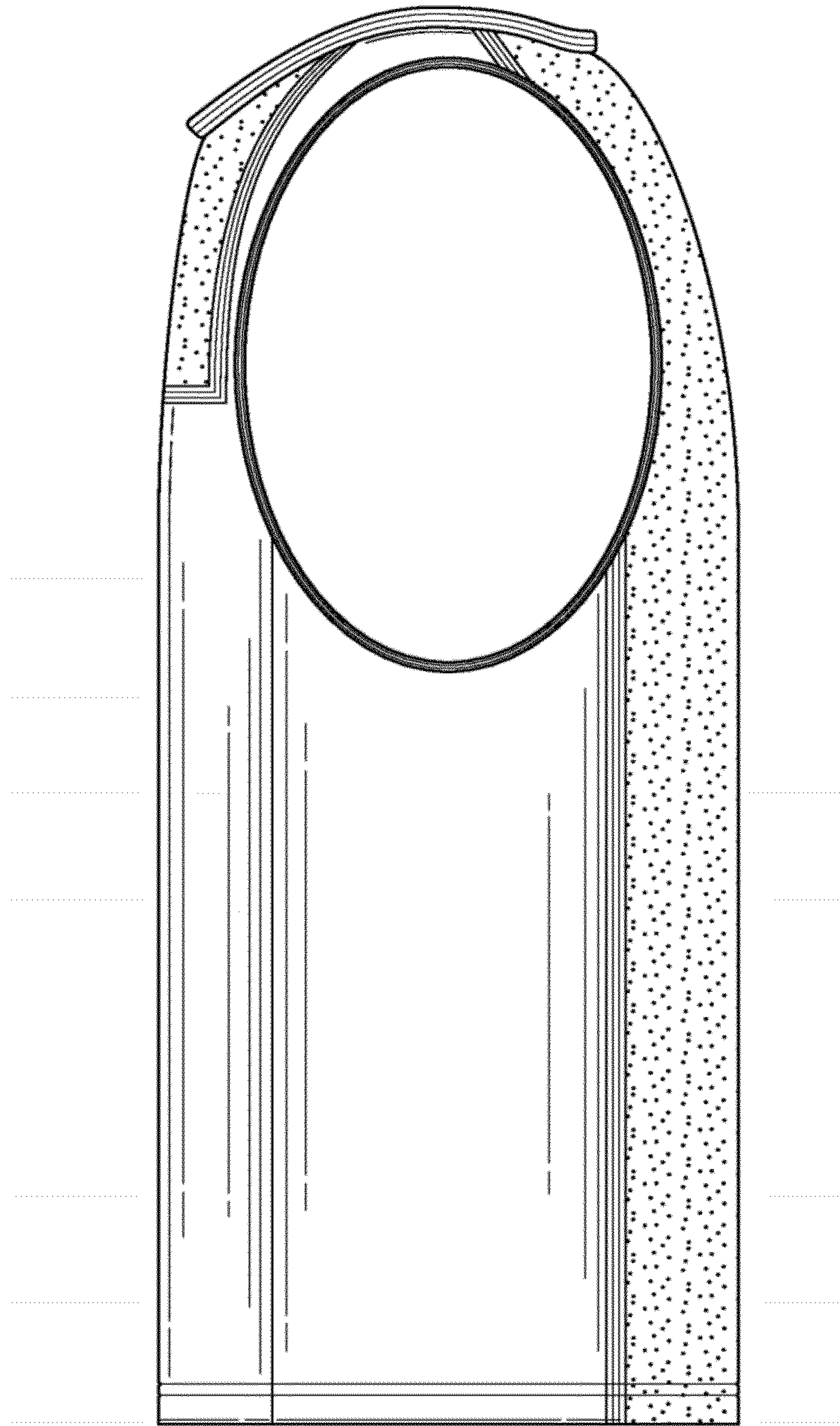

FIG. 4

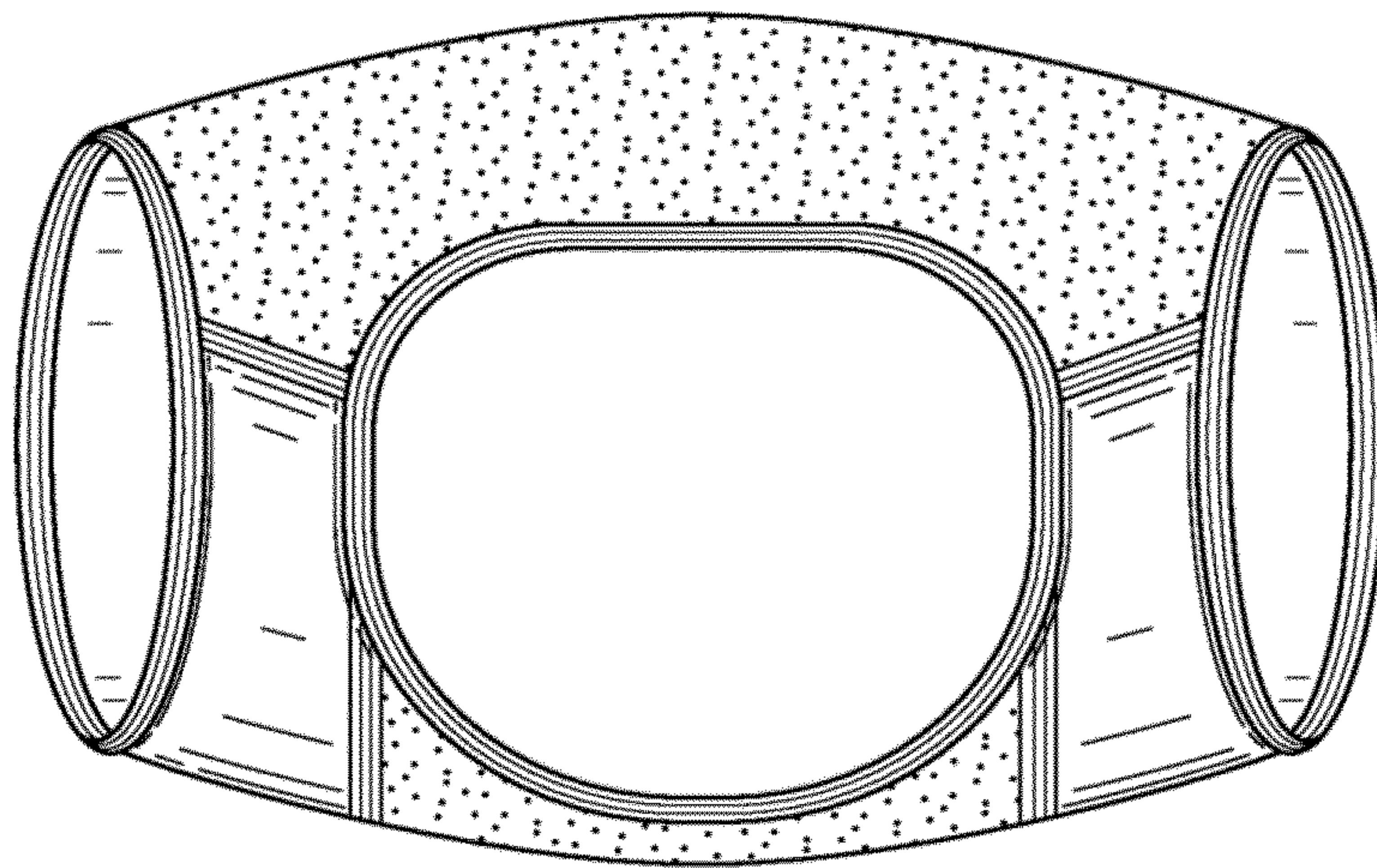

FIG. 5