



US00D838344S

(12) **United States Design Patent**  
**Lai et al.**

(10) **Patent No.:** **US D838,344 S**

(45) **Date of Patent:** **\*\* Jan. 15, 2019**

(54) **SHOWER HEAD**

(71) Applicant: **KYLIN SANITARY TECHNOLOGY (XIAMEN) CO., LTD.**, Xiamen, Fujian Province (CN)

(72) Inventors: **Cun Gui Lai**, Xiamen (CN); **Shu Qiang Liang**, Xiamen (CN); **Xi Jie Deng**, Xiamen (CN); **Qing Shuang Li**, Xiamen (CN)

(73) Assignee: **KYLIN SANITARY TECHNOLOGY (XIAMEN) CO., LTD.**, Xiamen, Fujian Province (CN)

(\*\*) Term: **15 Years**

(21) Appl. No.: **29/630,898**

(22) Filed: **Dec. 22, 2017**

(51) **LOC (11) Cl.** ..... **23-01**

(52) **U.S. Cl.**  
USPC ..... **D23/229**

(58) **Field of Classification Search**  
USPC ..... D23/213, 229, 230, 255, 257; 137/801; 4/678, 615  
CPC .... A47K 7/00; B05B 1/00; B05B 1/05; B05B 1/18; B05B 1/185; B05B 1/14; B05B 1/02  
See application file for complete search history.

(56) **References Cited**

**U.S. PATENT DOCUMENTS**

5,398,872 A \* 3/1995 Joubran ..... B05B 1/1654 239/99  
D531,261 S \* 10/2006 Tse ..... D23/213

D531,262 S \* 10/2006 Tse ..... D23/213  
D557,765 S \* 12/2007 Schonherr ..... D23/213  
D612,907 S \* 3/2010 Wu ..... D23/229  
D681,779 S \* 5/2013 Cutler ..... D23/229  
D705,896 S \* 5/2014 Bailey ..... D23/213  
D707,328 S \* 6/2014 Schoenherr ..... B05B 1/1654 D23/213

\* cited by examiner

*Primary Examiner* — Robin V Webster

(74) *Attorney, Agent, or Firm* — Muncy, Geissler, Olds & Lowe, P.C.

(57) **CLAIM**

The ornamental design for a shower head, as shown and described.

**DESCRIPTION**

FIG. 1 is a perspective view of a shower head showing our new design;  
FIG. 2 is a front elevational view thereof;  
FIG. 3 is a rear elevational view thereof;  
FIG. 4 is a left side elevational view thereof;  
FIG. 5 is a right side elevational view thereof;  
FIG. 6 is a top plan view thereof; and,  
FIG. 7 is a bottom plan view thereof.  
The broken lines illustrate portions of the shower head which form no part of the claimed design.

**1 Claim, 7 Drawing Sheets**

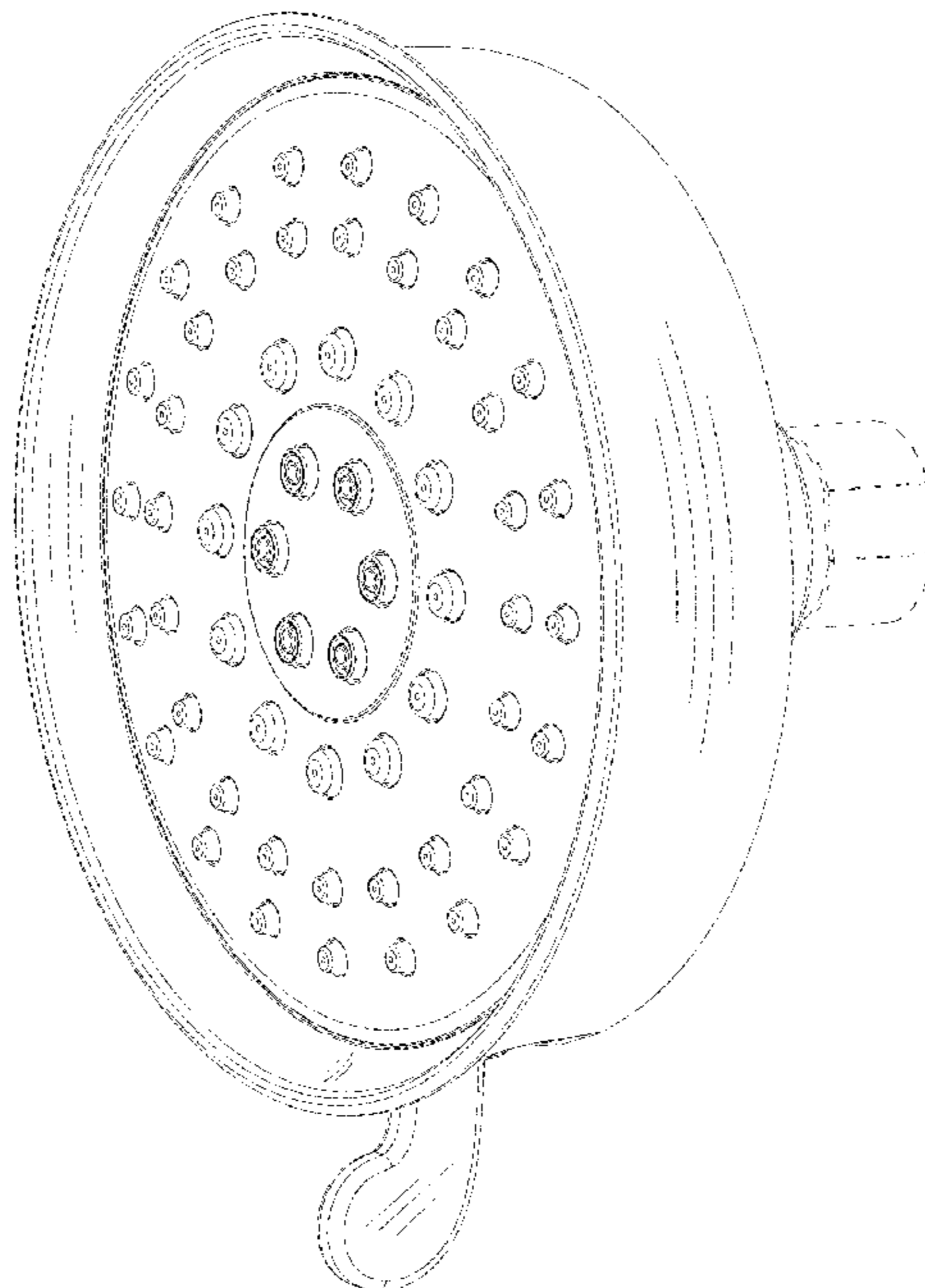

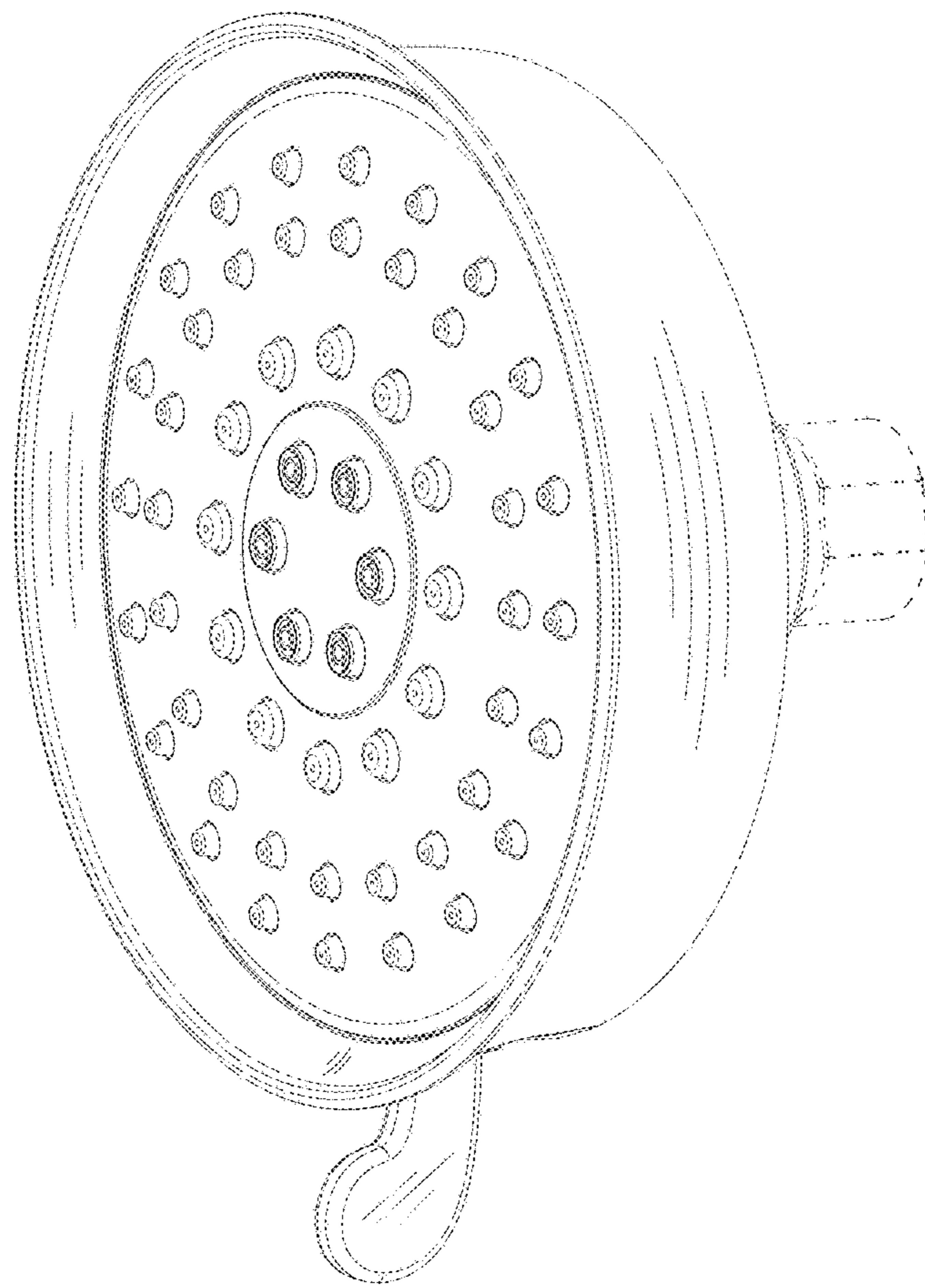

FIG. 1

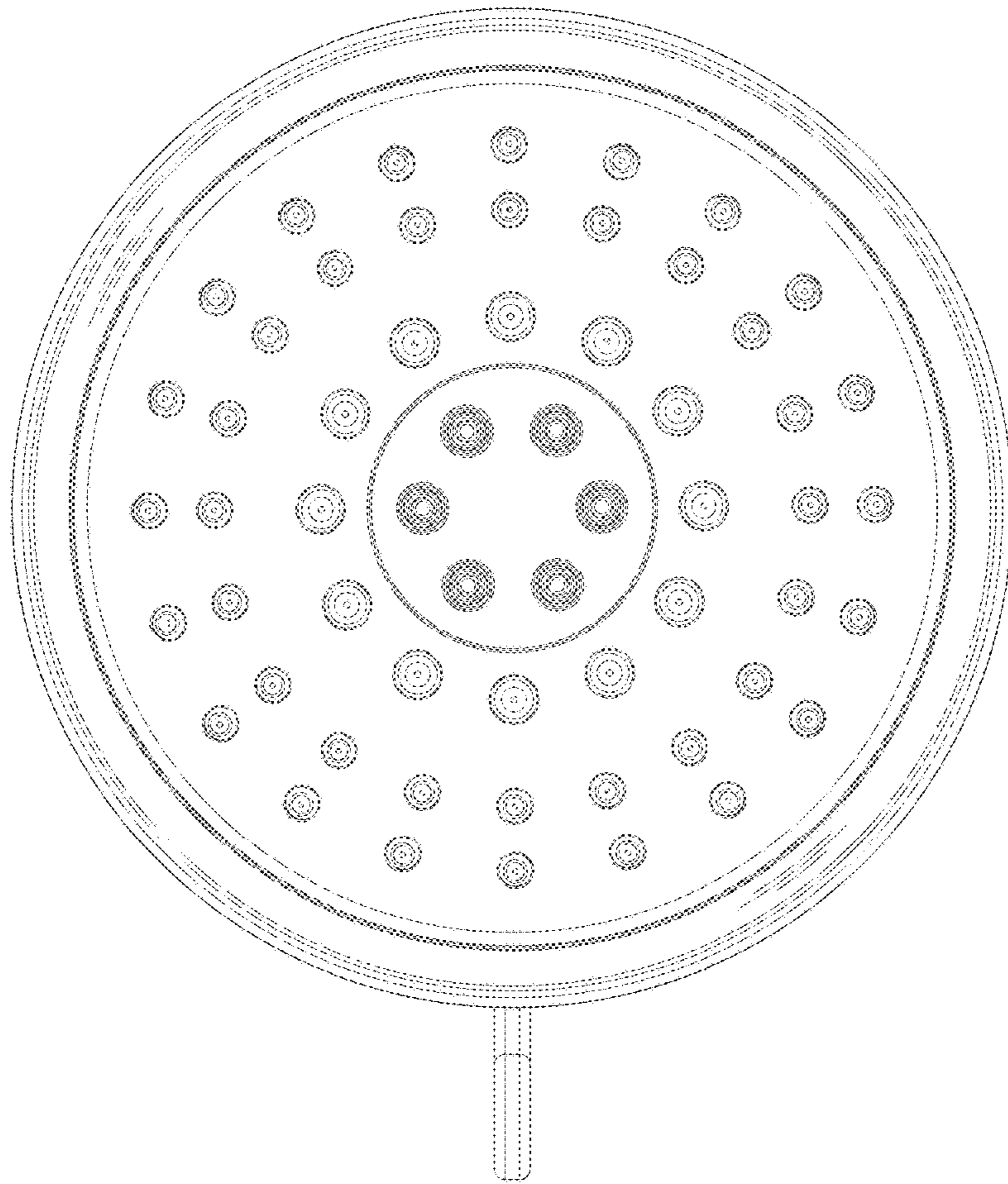

FIG. 2

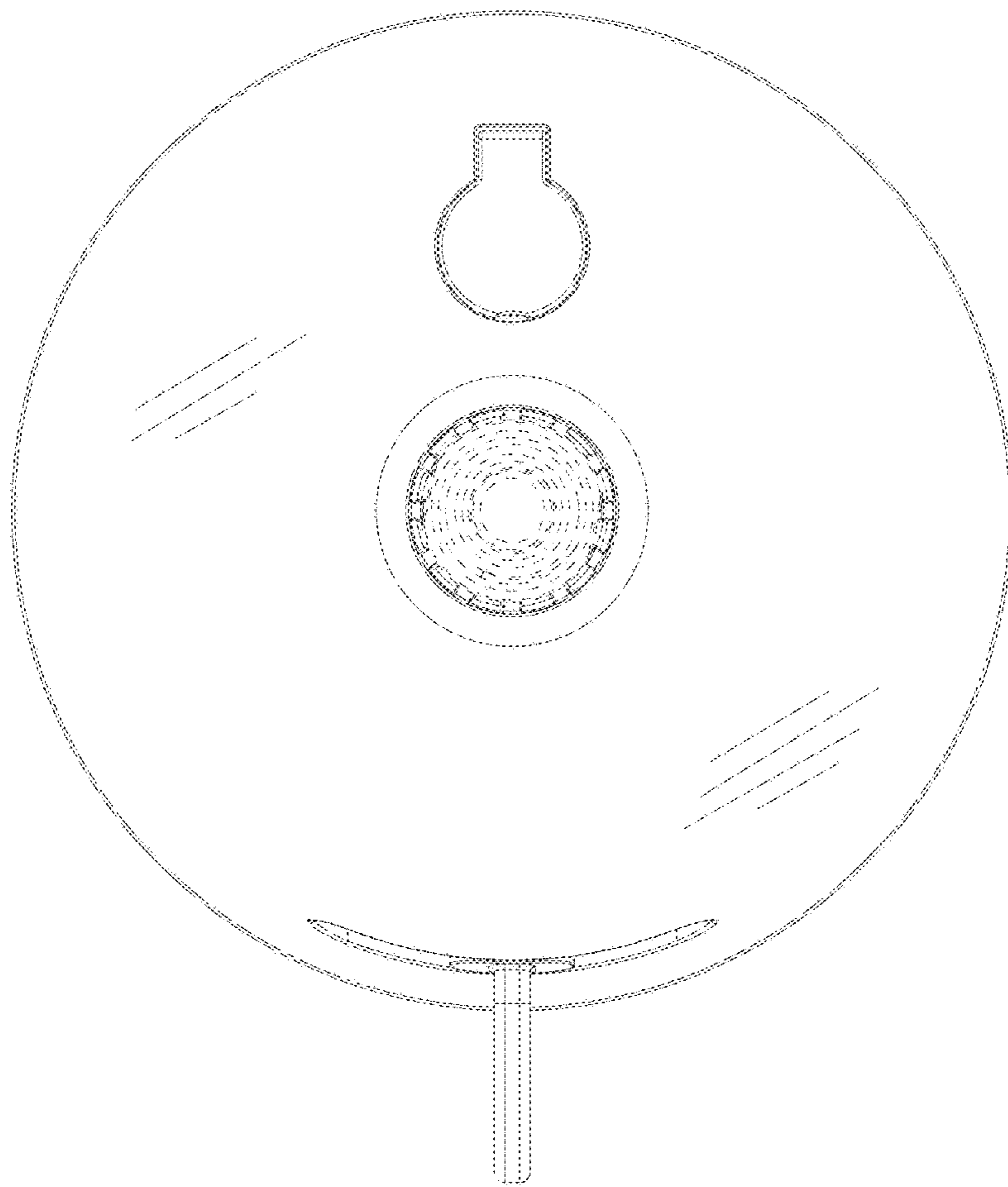

FIG. 3

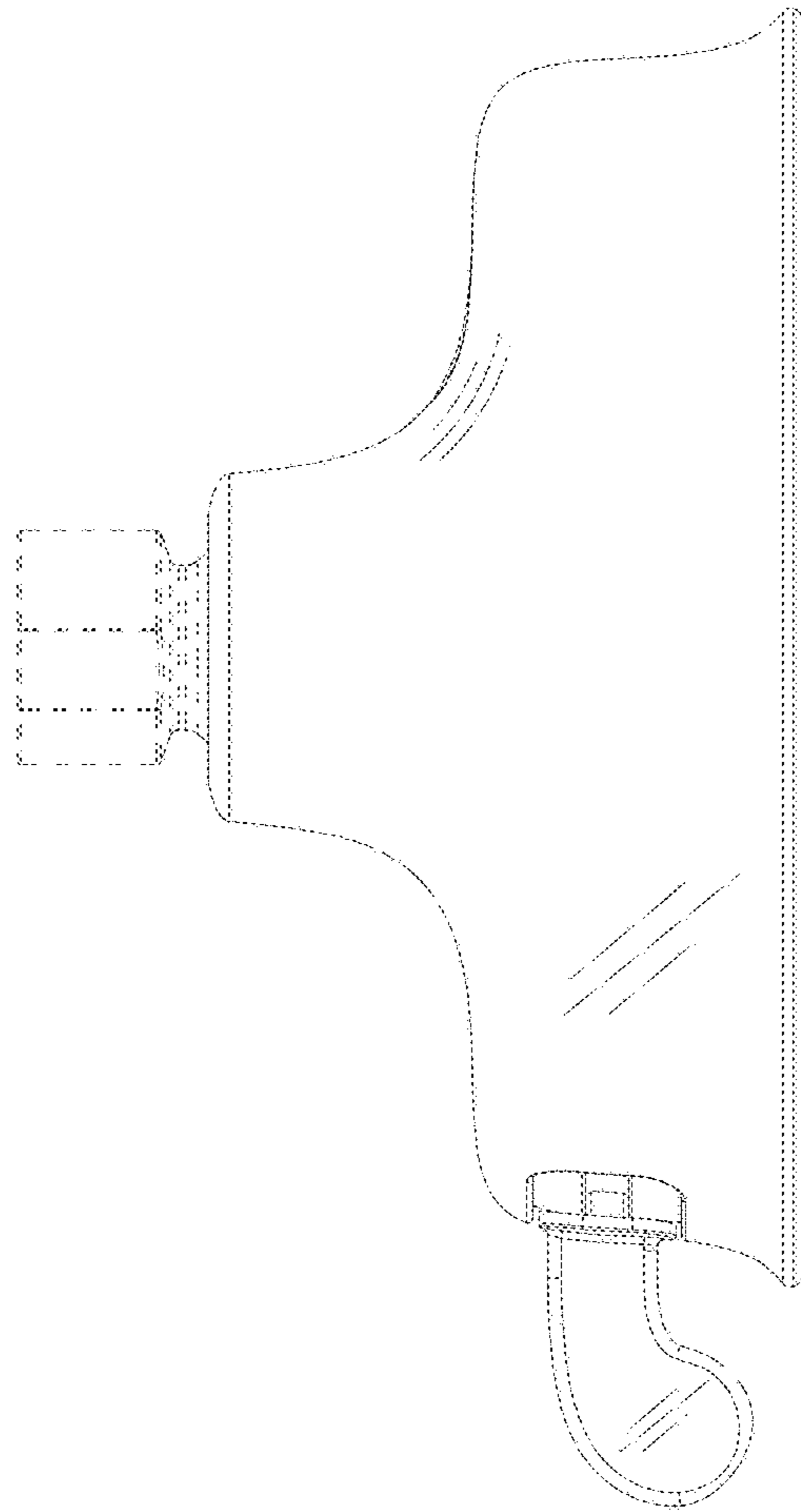

FIG. 4

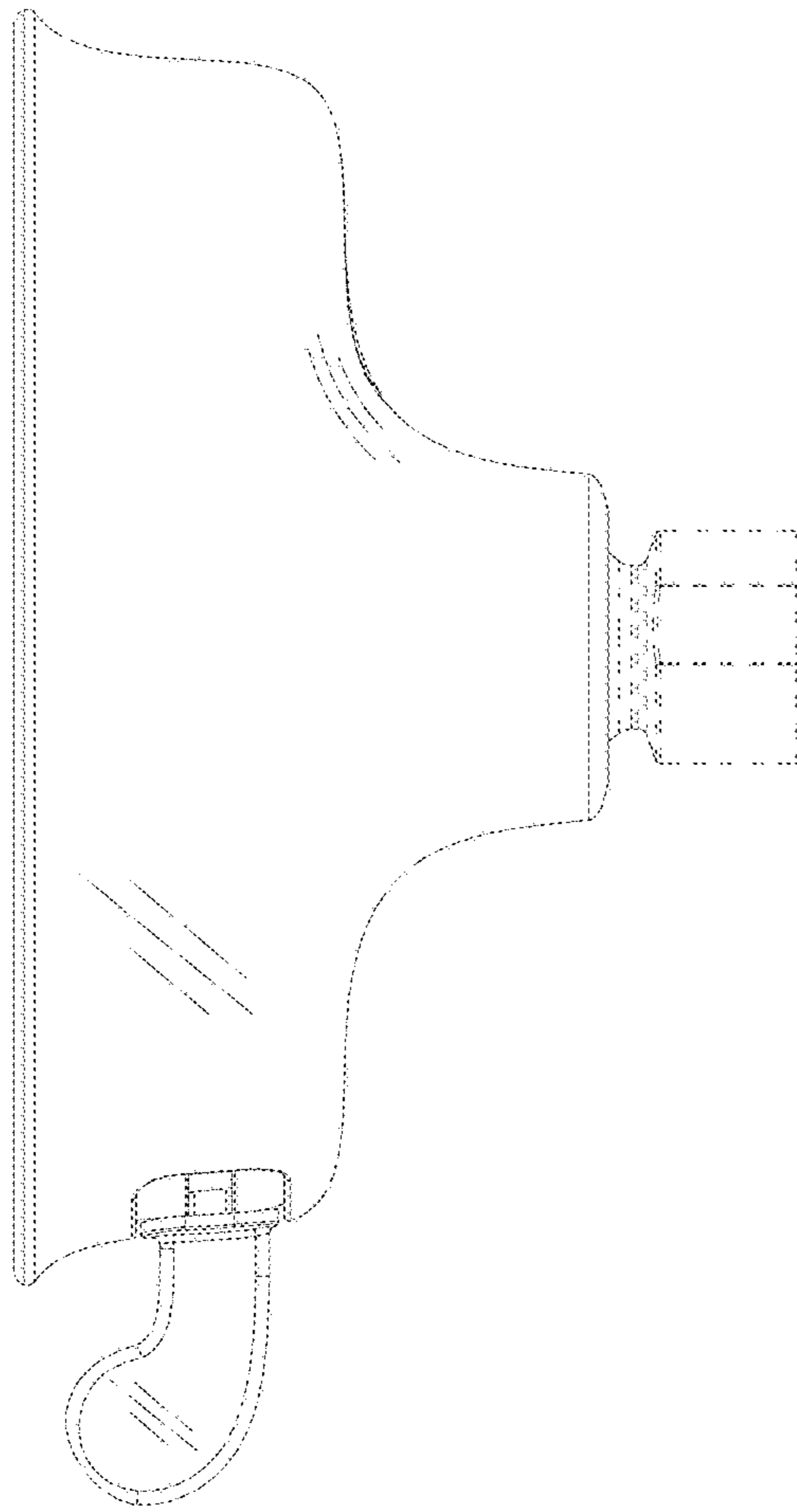

FIG. 5

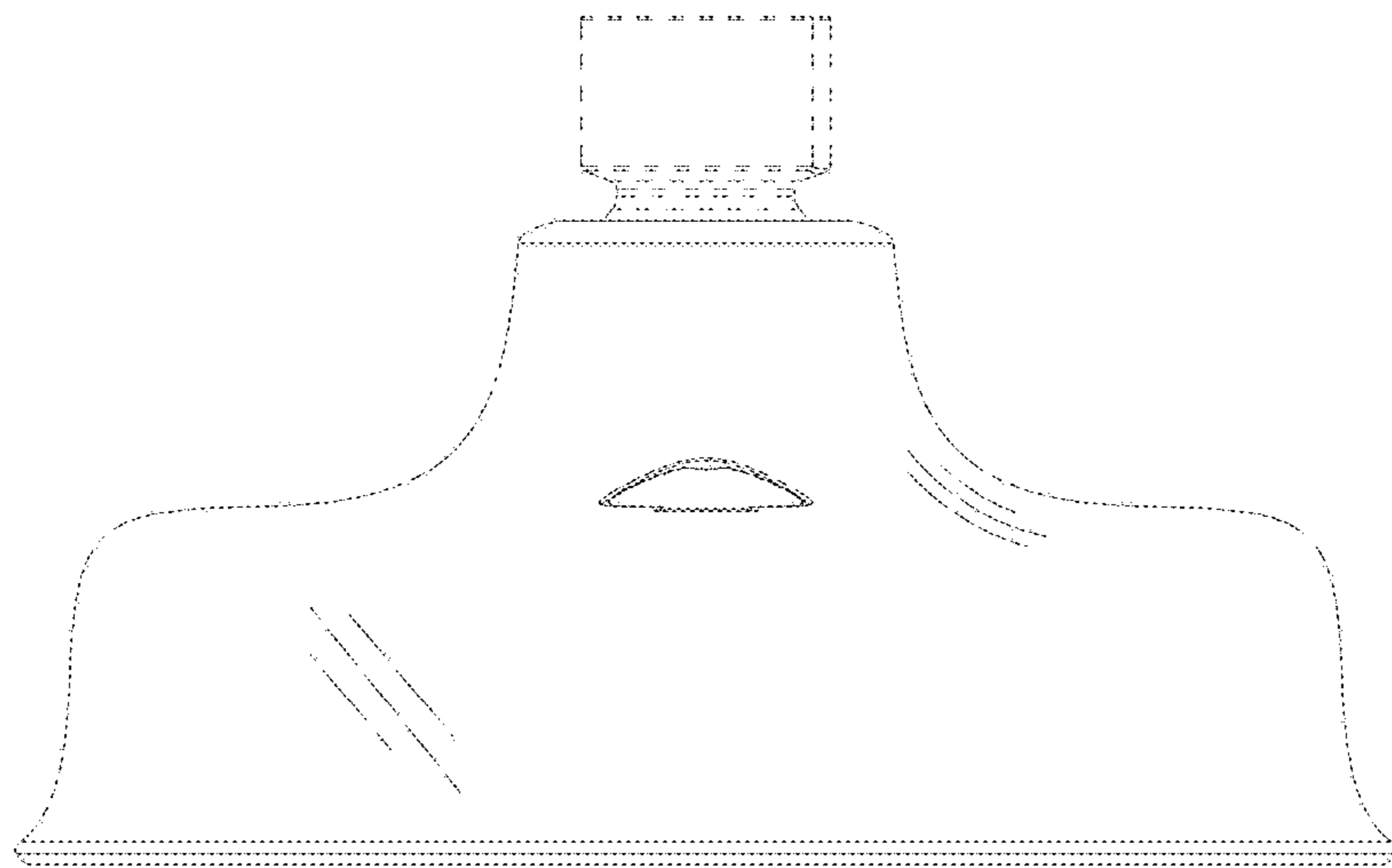

FIG. 6

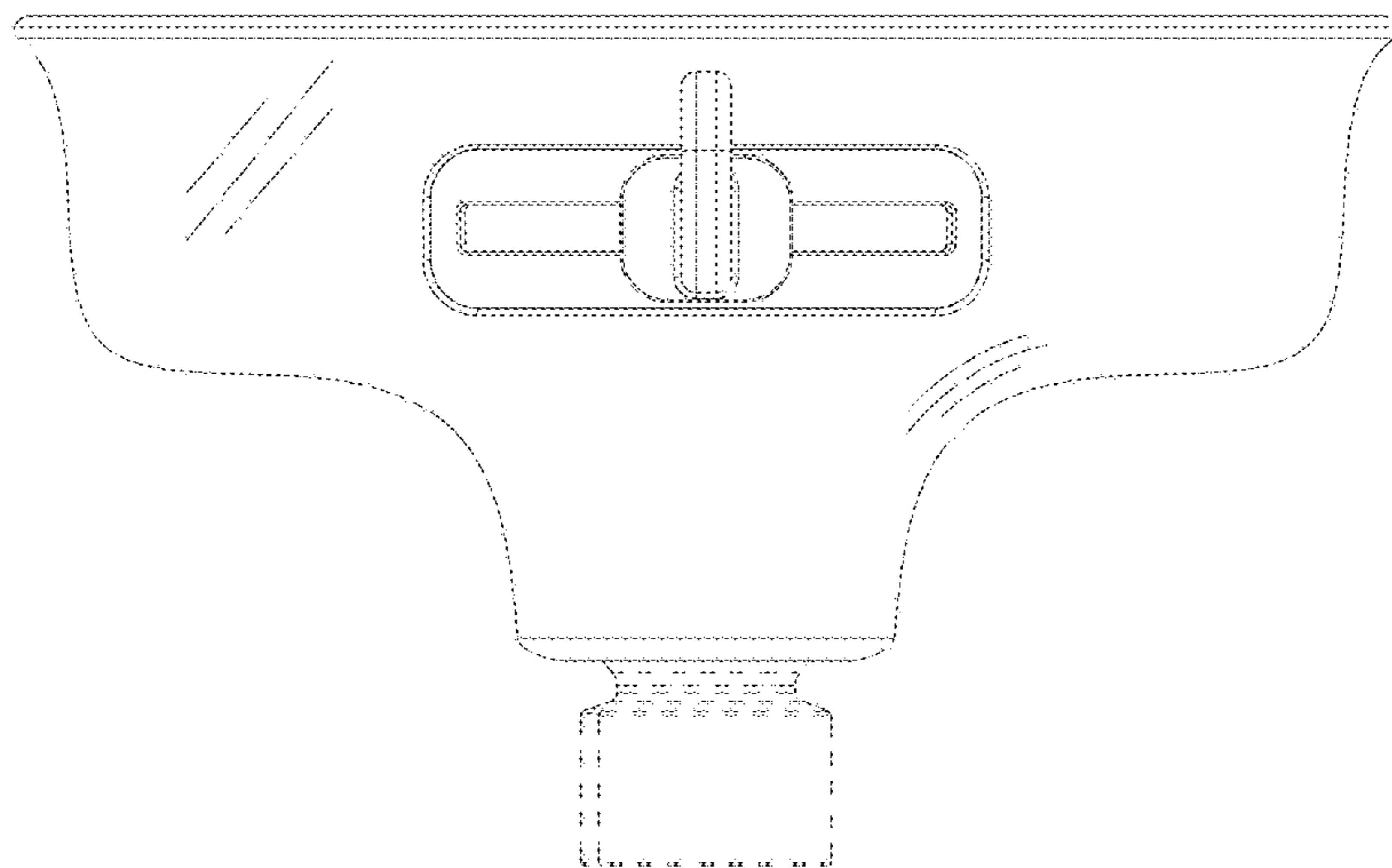

FIG. 7