

US00D838311S

(12) **United States Design Patent** (10) **Patent No.:** **US D838,311 S**
Maeda et al. (45) **Date of Patent:** **** *Jan. 15, 2019**

(54) **PRINTER**

(71) Applicant: **BROTHER INDUSTRIES, LTD.**,
Nagoya-shi, Aichi-ken (JP)

(72) Inventors: **Shino Maeda**, Nagoya (JP); **Takaaki Oguchi**, Kasugai (JP)

(73) Assignee: **BROTHER INDUSTRIES, LTD.**,
Nagoya (JP)

(*) Notice: This patent is subject to a terminal disclaimer.

(**) Term: **15 Years**

(21) Appl. No.: **29/570,506**

(22) Filed: **Jul. 8, 2016**

(30) **Foreign Application Priority Data**

Jan. 8, 2016 (JP) 2016-000282

(51) **LOC (11) Cl.** **19-02**

(52) **U.S. Cl.**
USPC **D18/19**

(58) **Field of Classification Search**
USPC D18/19, 53, 50, 54, 56, 59, 36, 38, 39,
D18/40, 41, 45, 34.4, 34.5, 34.6, 37, 14;
D14/314, 332, 348-349, 351, 352;
D19/68
CPC B41J 3/4075; B65C 11/00; B65C 11/02;
B65C 11/0205; B65C 11/021; B65C
11/0215; B65C 11/0221; B65C 11/0226;
B65C 11/0231; B65C 11/0236; B65C
11/0242; B65C 11/0252; B65C 11/0257;
B65C 11/0268; B65C 11/0273; B65C
11/0284; B65C 11/0289; B65C 11/0294;
B65C 11/04; B65C 11/046; B65C 11/06;
B65C 11/062; B65C 11/064; B65C
11/066; B65C 11/068

See application file for complete search history.

(56) **References Cited**

U.S. PATENT DOCUMENTS

D447,766	S	*	9/2001	Obara	D18/14
D522,571	S	*	6/2006	Senda	D18/54
D549,768	S	*	8/2007	Panebianco	D18/14
D654,949	S	*	2/2012	Preliasco	D18/14
D656,182	S	*	3/2012	Inada	D18/50
D713,871	S	*	9/2014	Preliasco	D18/14
D730,978	S	*	6/2015	Kinoshita	D18/50
D751,636	S	*	3/2016	Kinoshita	D18/19

(Continued)

FOREIGN PATENT DOCUMENTS

GB 2055913 * 8/1996

OTHER PUBLICATIONS

YouTube. <URL: <https://www.youtube.com/watch?v=6zSmqC6dYwA>.> Feb. 15, 2017. 10 Best Label Printers 2017.*

Primary Examiner — Bridget L Eland

Assistant Examiner — Lauren D McVey

(74) *Attorney, Agent, or Firm* — Oliff PLC

(57) **CLAIM**

The ornamental design for a printer, as shown and described.

DESCRIPTION

FIG. 1 is a top right perspective view of a printer, showing our new design;
FIG. 2 is a front elevation view thereof;
FIG. 3 is a top plan view thereof;
FIG. 4 is a right-side elevation view thereof;
FIG. 5 is a left-side elevation view thereof;
FIG. 6 is a rear elevation view thereof; and,
FIG. 7 is a bottom plan view thereof.
The broken lines that are immediately adjacent to the claim represent the bounds of the claimed design, while all other broken lines are directed to environment; the broken lines form no part of the claimed design.

1 Claim, 7 Drawing Sheets

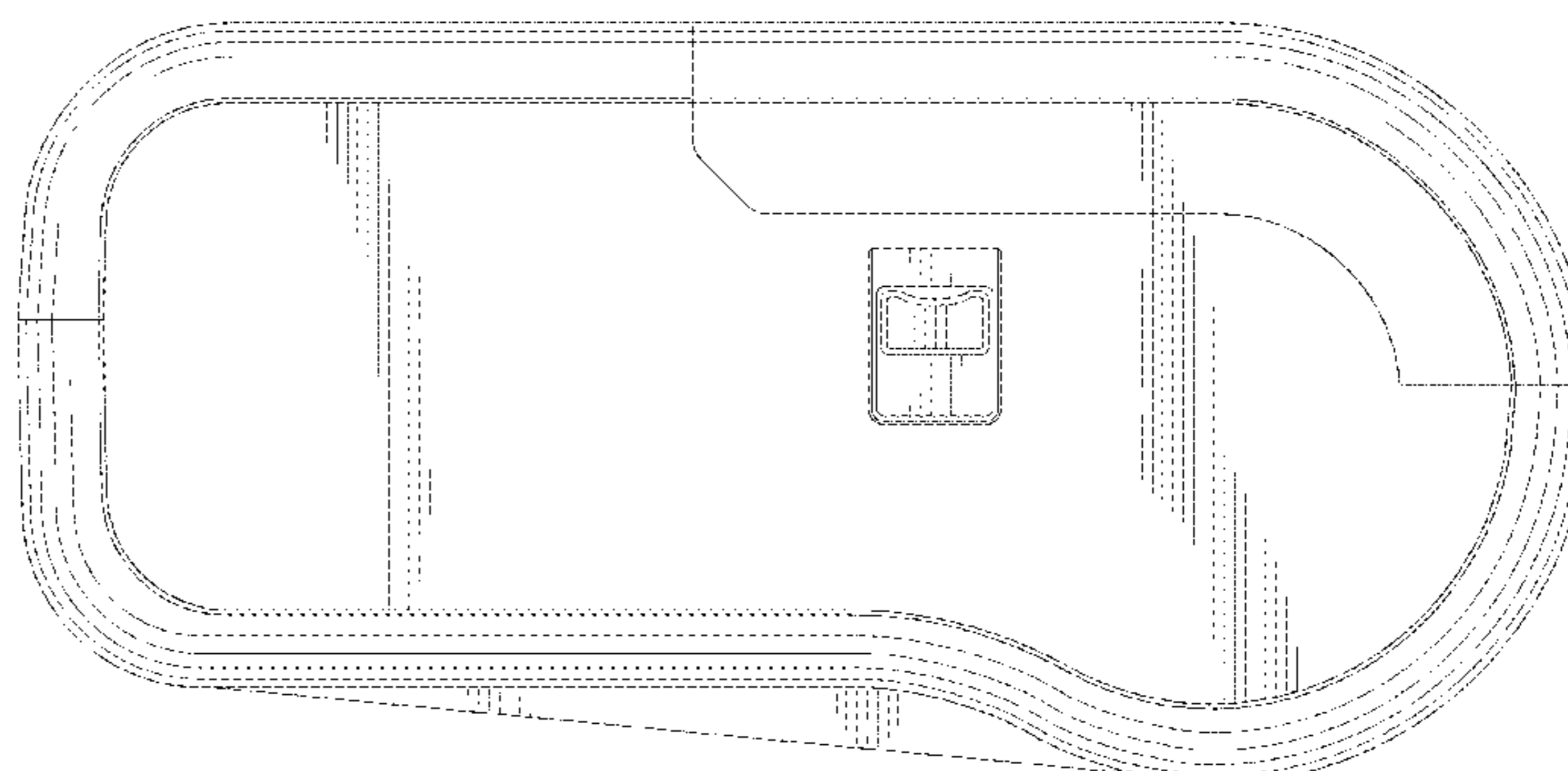
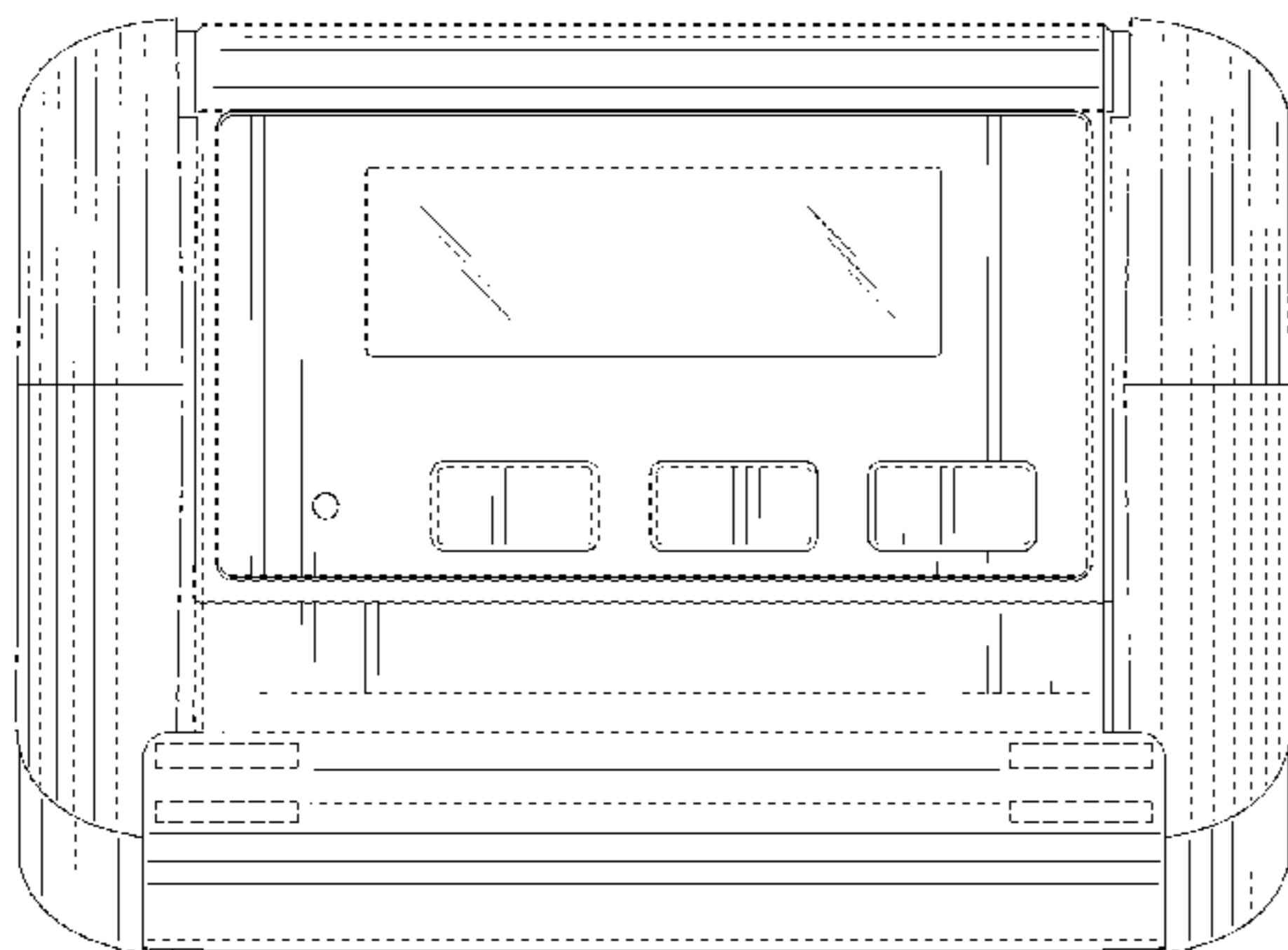

(56)

References Cited

U.S. PATENT DOCUMENTS

D752,140 S *	3/2016	Tanaka	D18/19
D758,481 S *	6/2016	Medugorac	D18/19
D777,249 S *	1/2017	Tanaka	D18/19
D820,351 S *	6/2018	Maeda	D18/19
2006/0279624 A1 *	12/2006	Tsuchiya	B41J 2/325 347/218
2014/0210937 A1 *	7/2014	Nomura	B41J 11/0055 347/218

* cited by examiner

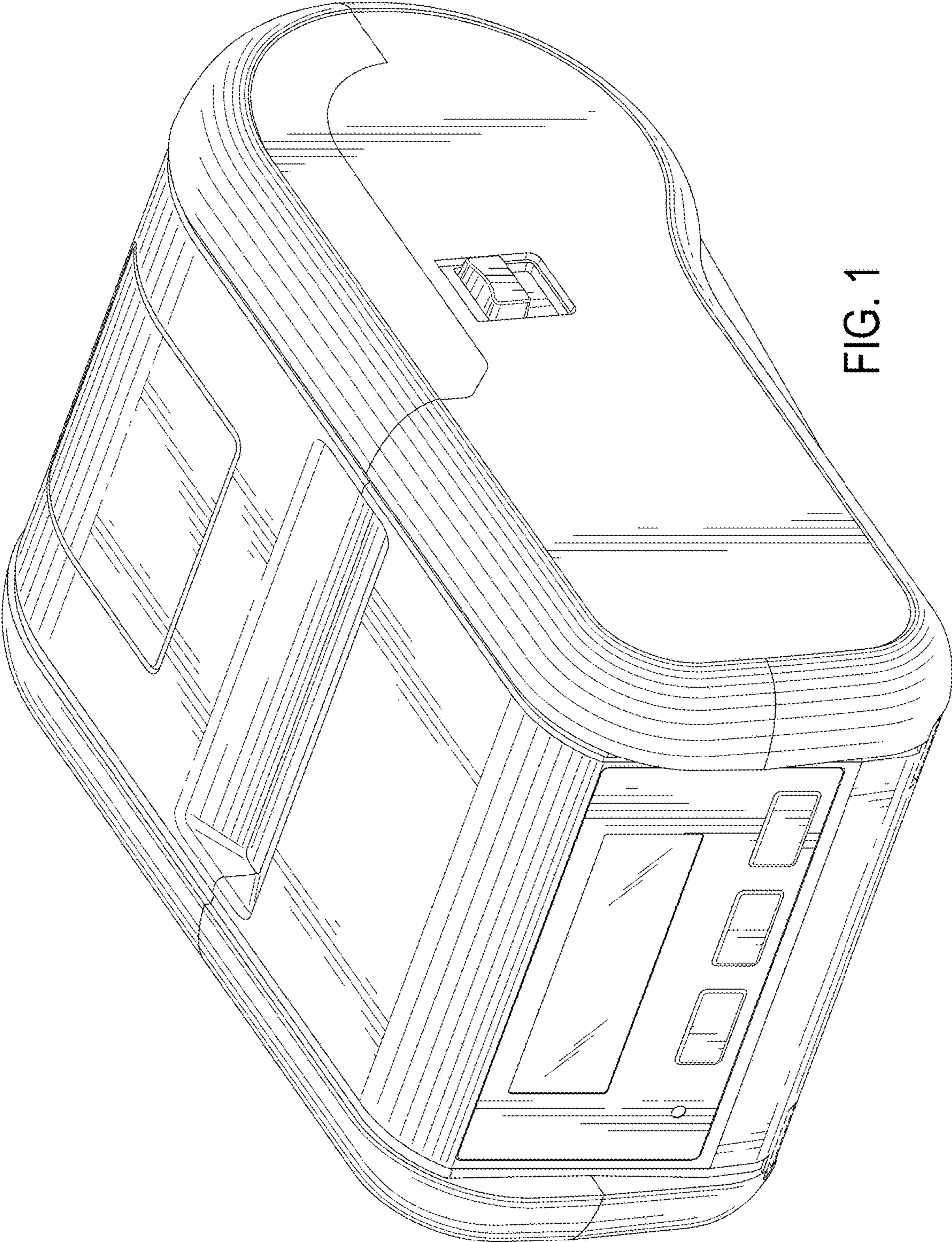

FIG. 1

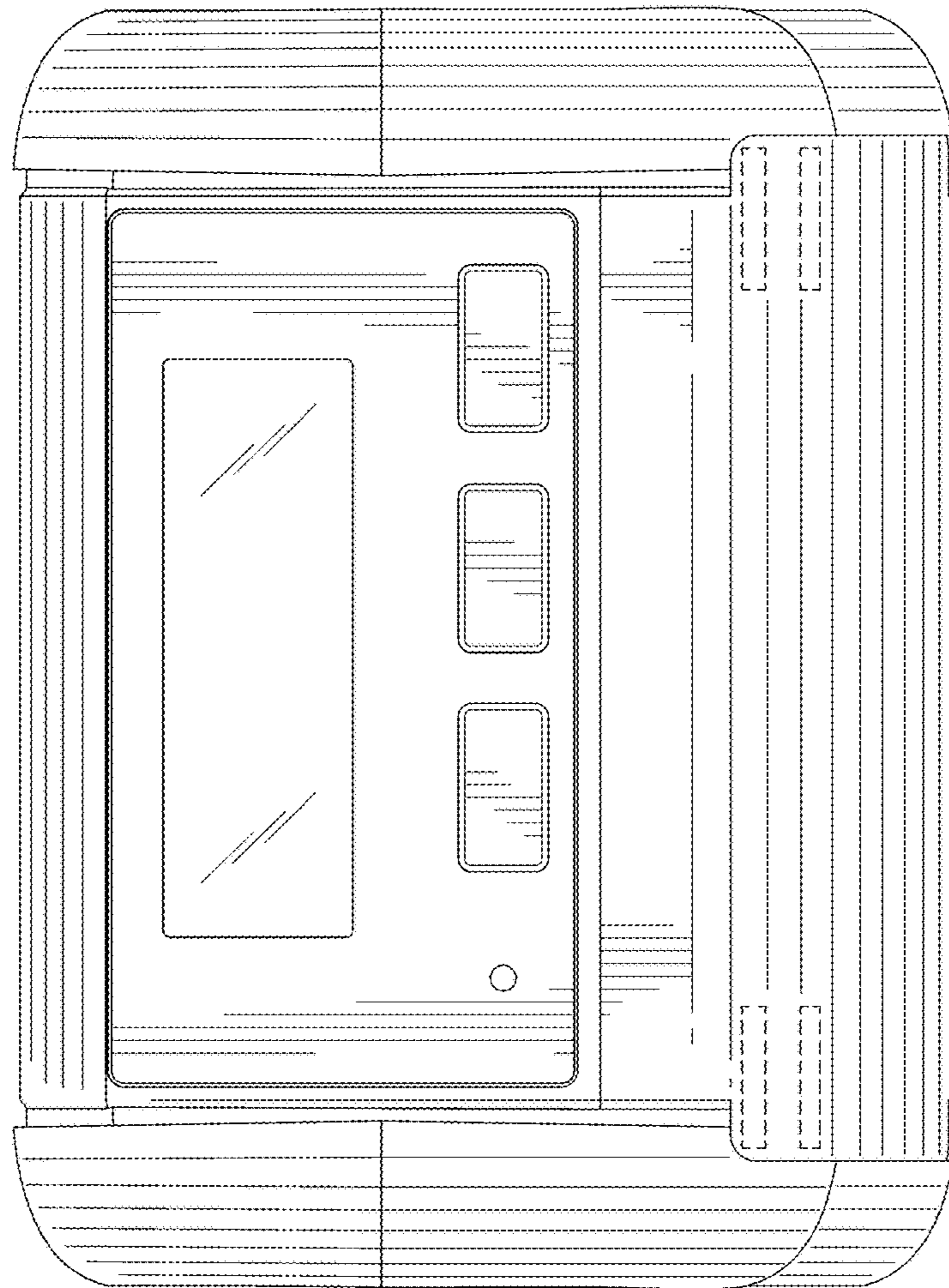

FIG. 2

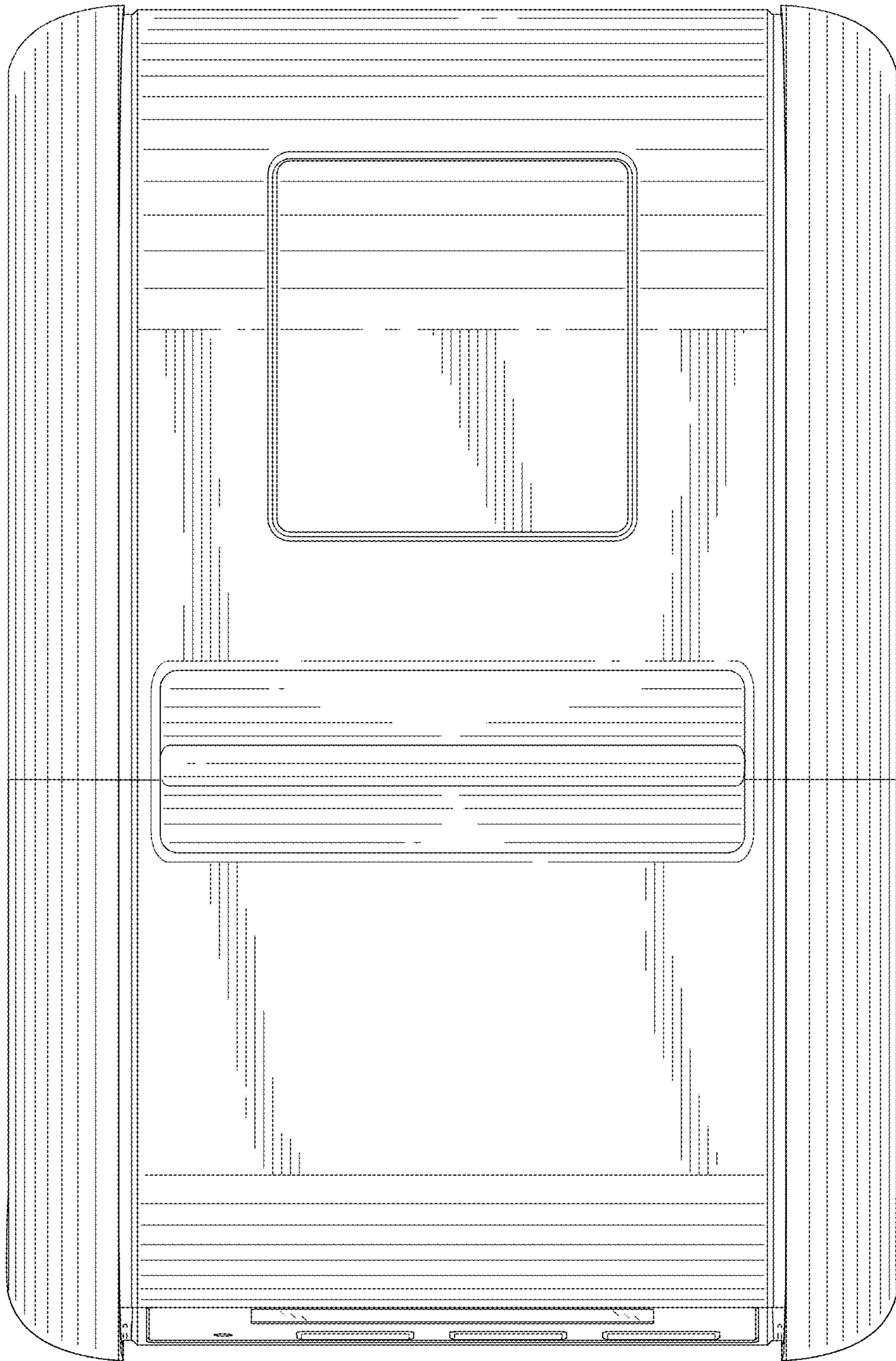

FIG. 3

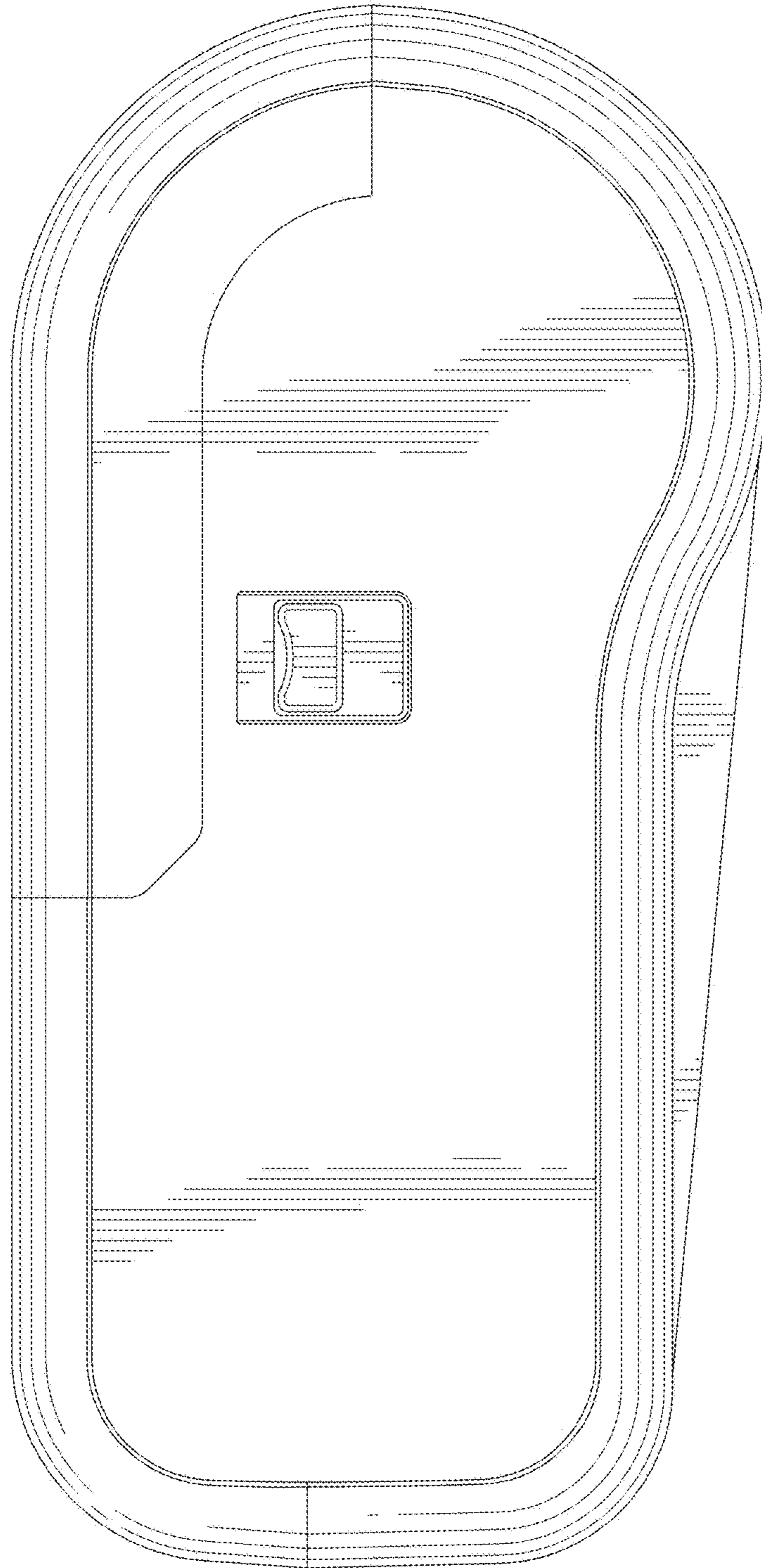

FIG. 4

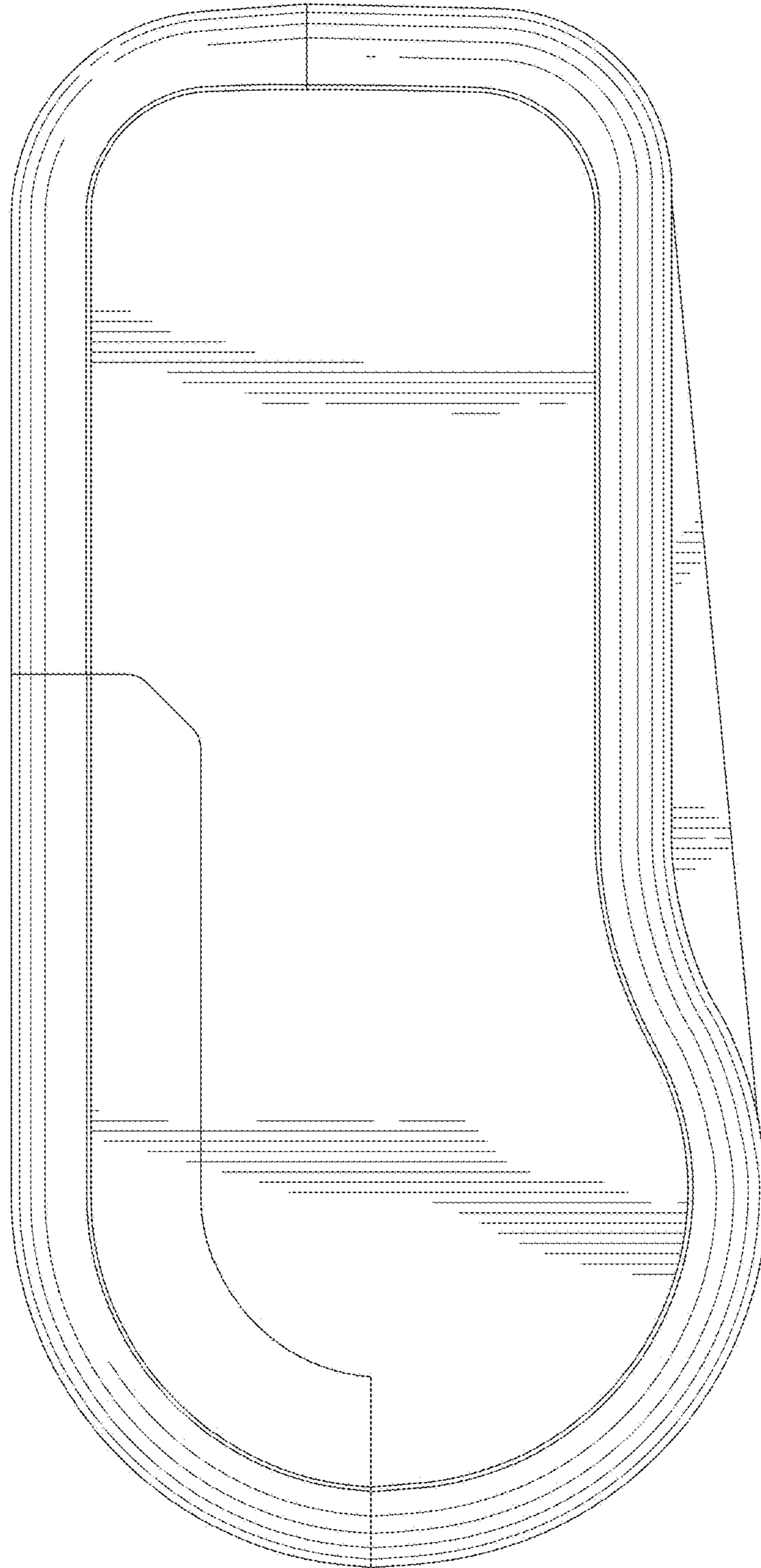

FIG. 5

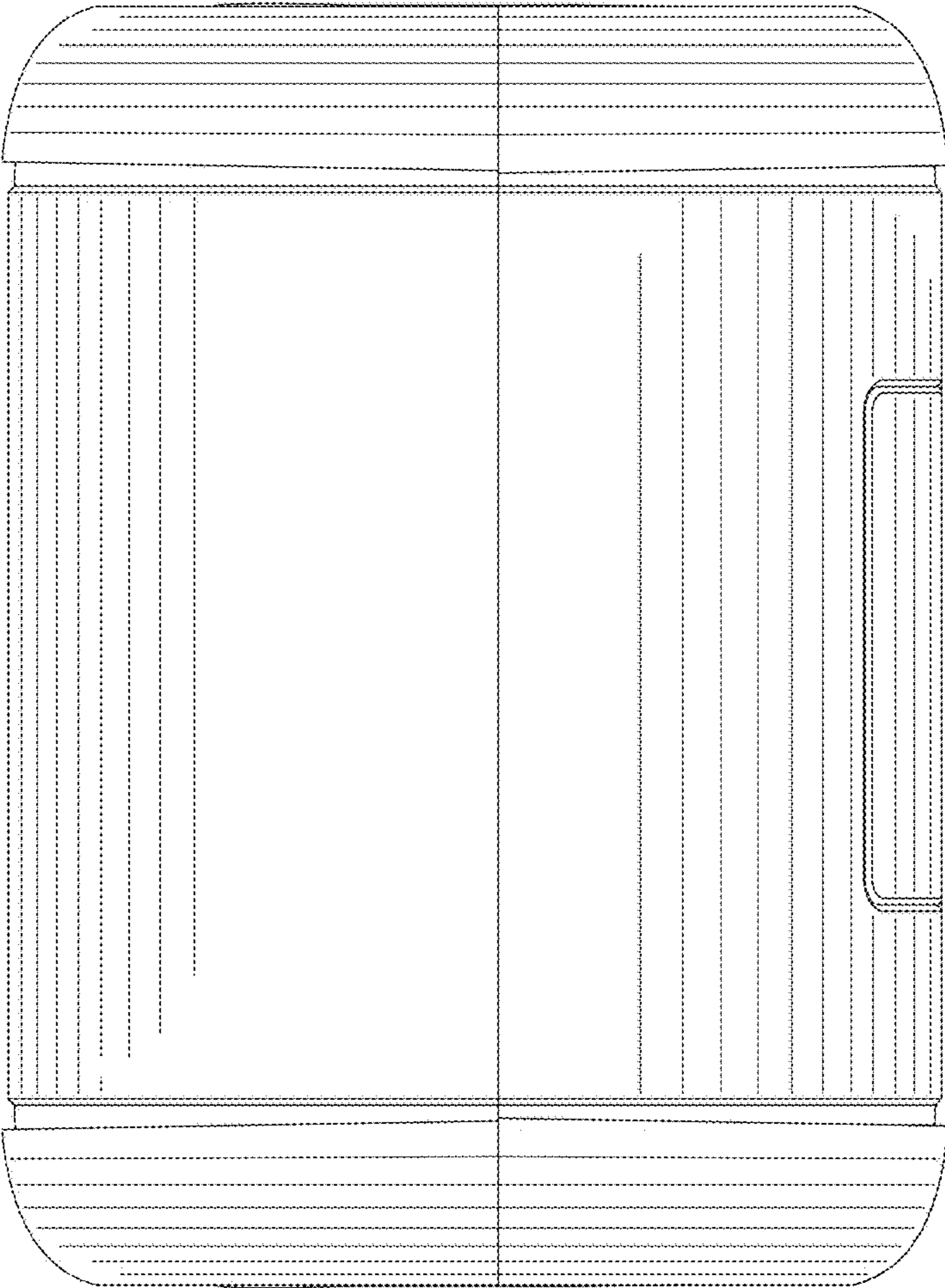

FIG. 6

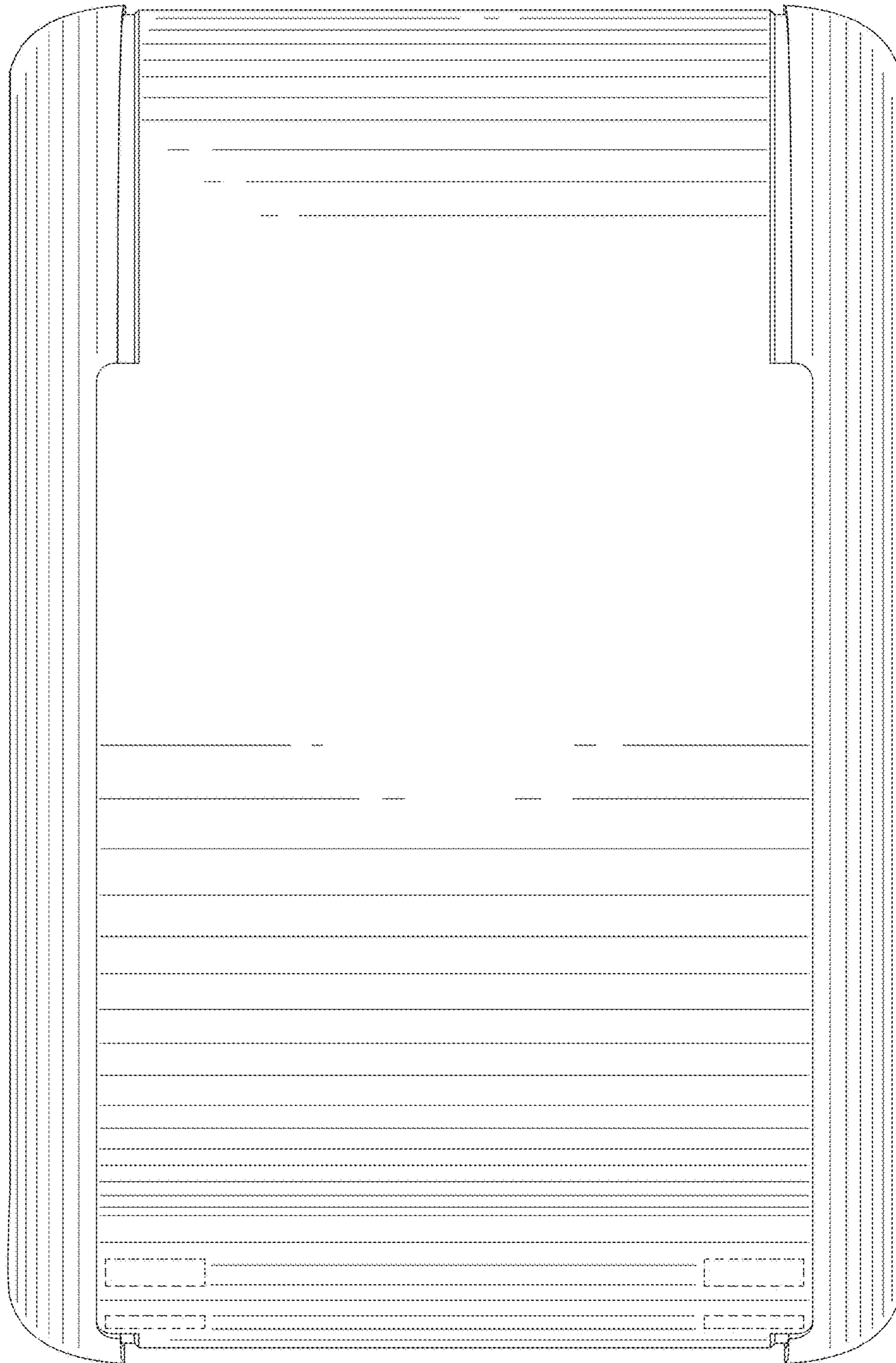

FIG. 7