



US00D838136S

(12) **United States Design Patent** (10) **Patent No.:** **US D838,136 S**
Liu (45) **Date of Patent:** **** Jan. 15, 2019**

(54) **KNIFE HANDLE**
(71) Applicant: **Yunxing Liu**, Irvine, CA (US)
(72) Inventor: **Yunxing Liu**, Irvine, CA (US)
(**) Term: **15 Years**
(21) Appl. No.: **29/591,580**
(22) Filed: **Jan. 20, 2017**
(51) **LOC (11) Cl.** **07-99**
(52) **U.S. Cl.**
USPC **D7/401.2**
(58) **Field of Classification Search**
USPC D7/642-654, 662, 664, 666, 669, 672,
D7/673, 676, 681-683, 687, 688,
D7/691-697, 401, 401.1, 401.2, 387, 393,
D7/213; D8/7, 9, 12, 33, 48, 75, 76, 77,
D8/80, 81, 83, 93, 94, 95, 97, 98, 99,
D8/100, 101, 102, 103, 104, 105, 106,
D8/107, 300, 303, 118; D22/118;
30/136, 142, 143, 144, 145, 146, 147,
30/148, 149, 150, 161, 295, 315, 329,
30/340, 341, 342, 343, 344, 345, 346,
30/347, 348, 353, 354, 355, 356; 7/118;
16/110, 430, 431
CPC A47G 21/02; A47G 21/06; A47G 21/08;
A47G 21/04; B26B 11/00; B26B 29/025;
B26B 1/00; B26B 1/08; B26B 1/10;
B26B 3/00; B26B 3/02; B26B 3/03;
B26B 5/007; B26B 7/00; B26B 7/005;
B26B 11/006; B26B 11/001; B26B
11/003; B26B 11/005; B26B 11/008;
B26B 21/04; B26B 21/4006; B26B 3/04
See application file for complete search history.

(56) **References Cited**
U.S. PATENT DOCUMENTS
495,110 A * 4/1893 Hayes B26B 9/02
30/355
D54,277 S * 12/1919 Michaelis 30/279.6

1,847,062 A * 2/1932 Lemmon, Jr. A21C 15/007
30/304
2,995,821 A * 8/1961 Gordon B21J 15/02
29/509
D296,179 S * 6/1988 Hagberg D7/649
D316,015 S * 4/1991 DiGangi D7/649
D494,006 S * 8/2004 Zemel D7/395
D637,048 S * 5/2011 Ono D7/649
D649,411 S * 11/2011 Lo D7/649
(Continued)

OTHER PUBLICATIONS

“Cangshan Swedish Knife Set,” available Feb. 2, 2017, [online],
[site visited Mar. 9, 2018]. Available from Internet, URL:https://
www.amazon.com/Cangshan-62304-Swedish-Sandvik-4-Piece/dp/
B01NAPB35B (Year: 2017).*
(Continued)

Primary Examiner — Cathron C Brooks
Assistant Examiner — Katrina N Gonzalez

(57) **CLAIM**

The ornamental design for a knife handle, as shown and described.

DESCRIPTION

FIG. 1 is a left side perspective view of the knife handle, the right-side being a mirror image, showing my design.
FIG. 2 is a left-side view of the knife handle thereof, the right-side being a mirror image.
FIG. 3 is a top view thereof.
FIG. 4 is a bottom view thereof.
FIG. 5 is an enlarged rear view thereof; and,
FIG. 6 is an enlarged front view thereof.
The broken lines shown in FIGS. 1 through 6 illustrate environmental structure that form no part of the claimed design. The broken lines shown on the knife handle in FIGS. 1, 2 and 5 illustrate portions of the knife handle that form no part of the claimed design.

1 Claim, 4 Drawing Sheets

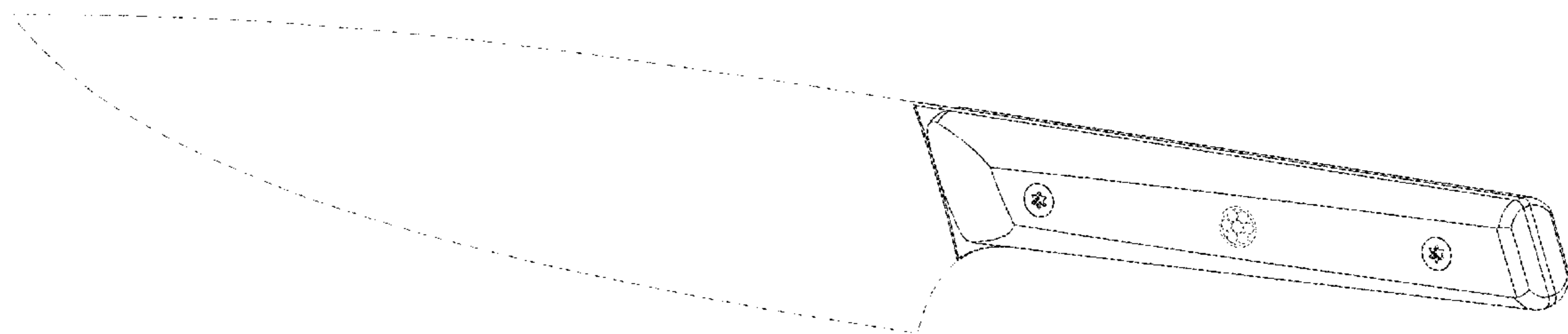

(56)

References Cited

U.S. PATENT DOCUMENTS

D649,840	S	*	12/2011	Lo	D7/649
D770,850	S	*	11/2016	Keating	D7/401.2
D773,886	S	*	12/2016	McConnell	D7/401.2
D773,888	S	*	12/2016	Liu	D7/401.2
D773,891	S	*	12/2016	Liu	D7/401.2
D792,151	S	*	7/2017	Berger	D7/401.2
D803,011	S	*	11/2017	Liu	D7/649
D807,696	S	*	1/2018	Liu	D7/401.2
D809,862	S	*	2/2018	Petsche	D7/401.2
D809,863	S	*	2/2018	Yamada	D7/401.2
2012/0079725	A1	*	4/2012	Hatch	B26B 3/00 30/295
2017/0165850	A1	*	6/2017	Rigas	B26B 3/00

OTHER PUBLICATIONS

“KAI 5700 Personal Folding Steak Knife 3,” available Jul. 8, 2016, [online], [site visited Mar. 9, 2018]. Available from Internet, URL:<https://www.knifecenter.com/item/KS5700/kai-5700-personal-folding-steak-knife-satin-blade-zytel-handles-leather-sheath> (Year: 2016).*

“Just Finished Full Tang Thuya Burl Hunter and Sheath BladeForums,” available Apr. 18, 2016, [online], [site visited Mar. 9, 2018]. Available from Internet, URL:<https://www.bladeforums.com/threads/just-finished-full-tang-thuya-burl-hunter-sheath.1387691/> (Year: 2016).*

“Xinzuo,” available Feb. 20, 2017, [online], [site visited Mar. 9, 2018]. Available from Internet, URL:<https://www.amazon.com/>

XINZUO-Damascus-Stainless-Kitchen-Hammered/dp/B06VY2Z717/ref=sr_1_1?s=home-garden&ie=UTF8&qid=1520630119&sr=1-1&keywords=xinzuo (Year: 2018).*

“Xinzuo 10 inches Damascus Chef Knife,” available Jun. 22, 2017, [online], [site visited Mar. 9, 2018]. Available from Internet, URL:https://www.amazon.com/XINZUO-Damascus-Stainless-Professional-Rosewood/dp/B0736T2MWZ/ref=sr_1_9?s=home-garden&ie=UTF8&qid=1520630119&sr=1-9&keywords=xinzuo (Year: 2017).*

“Orient Japanese Damascus Steel 9,” available Feb. 8, 2018, [online], [site visited Mar. 9, 2018]. Available from Internet, URL:https://www.amazon.com/Orient-Japanese-Damascus-Cleaning-Cooking/dp/B06Y31P5P3/ref=sr_1_1?s=home-garden&ie=UTF8&qid=1520630351&sr=1-1&keywords=orient+knives (Year: 2018).*

“Zelite Infinity Serrated Utility Knife 5,” available Dec. 18, 2015, [online], [site visited Mar. 9, 2018]. Available from Internet, URL:https://www.amazon.com/ZELITE-INFINITY-Serrated-Utility-Knife/dp/B019ITXD4S/ref=sr_1_1_sspa?ie=UTF8&qid=1520630484&sr=8-1-spons&keywords=zelite+infinity+serrated&psc=1 (Year: 2015).*

“Shun Hiro SG2,” available Jul. 25, 2017, [online], [site visited Mar. 9, 2018]. Available from Internet, URL:https://www.amazon.com/Shun-Hiro-7-piece-Knife-Block/dp/B0747WFL2C/ref=sr_1_7?s=home-garden&ie=UTF8&qid=1520630616&sr=1-7&keywords=shun+hiro+sg2 (Year: 2017).*

“Hanzo Chef Knife Professional Knives—9,” available Mar. 9, 2018, [online], [site visited Mar. 9, 2018]. Available from Internet, URL:<https://www.gethanzo.com/products/hanzo-chefs-knife-9-5-inch> (Year: 2018).*

* cited by examiner

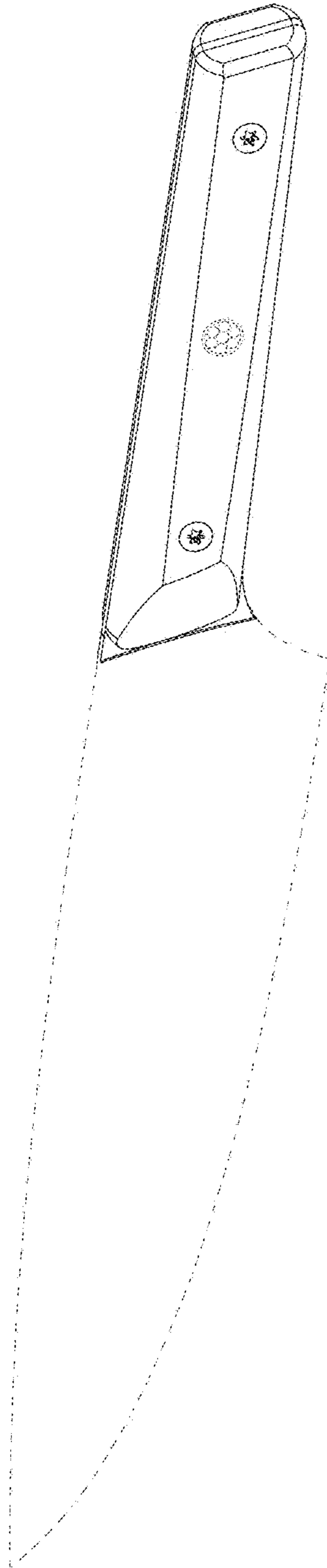

Fig. 1

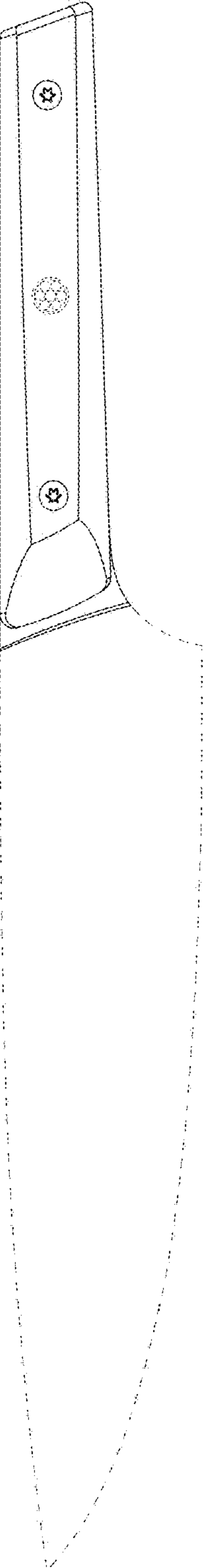

Fig. 2

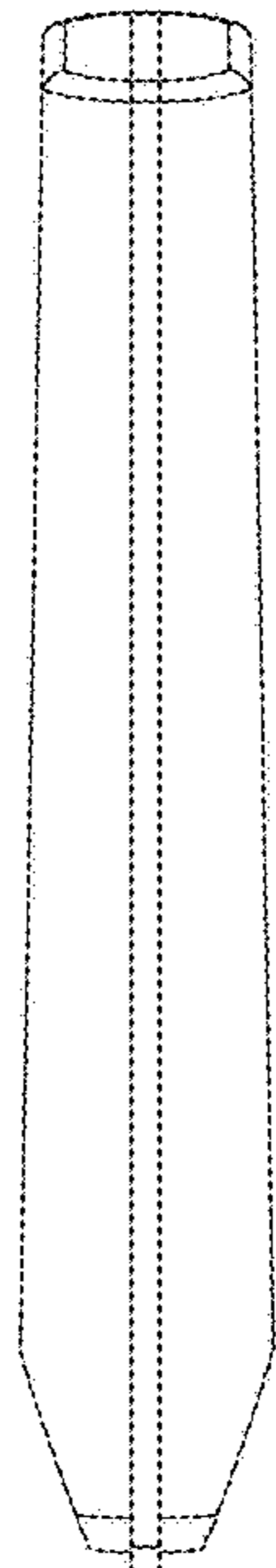

Fig. 3

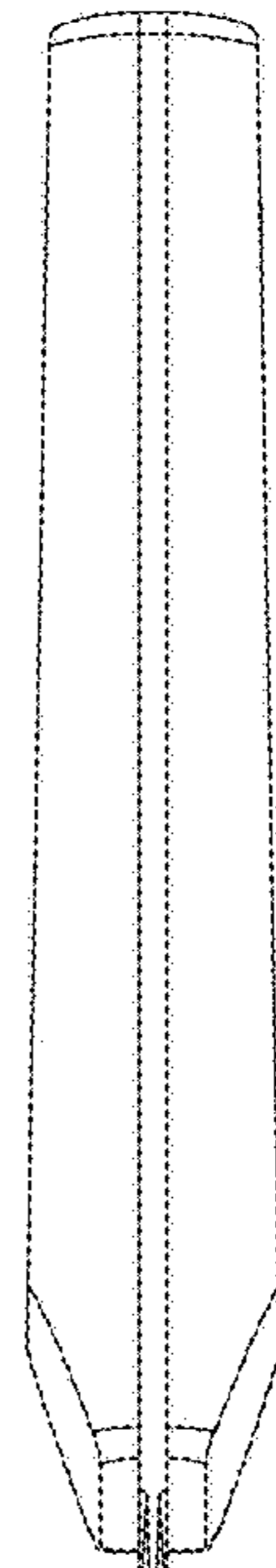

Fig. 4

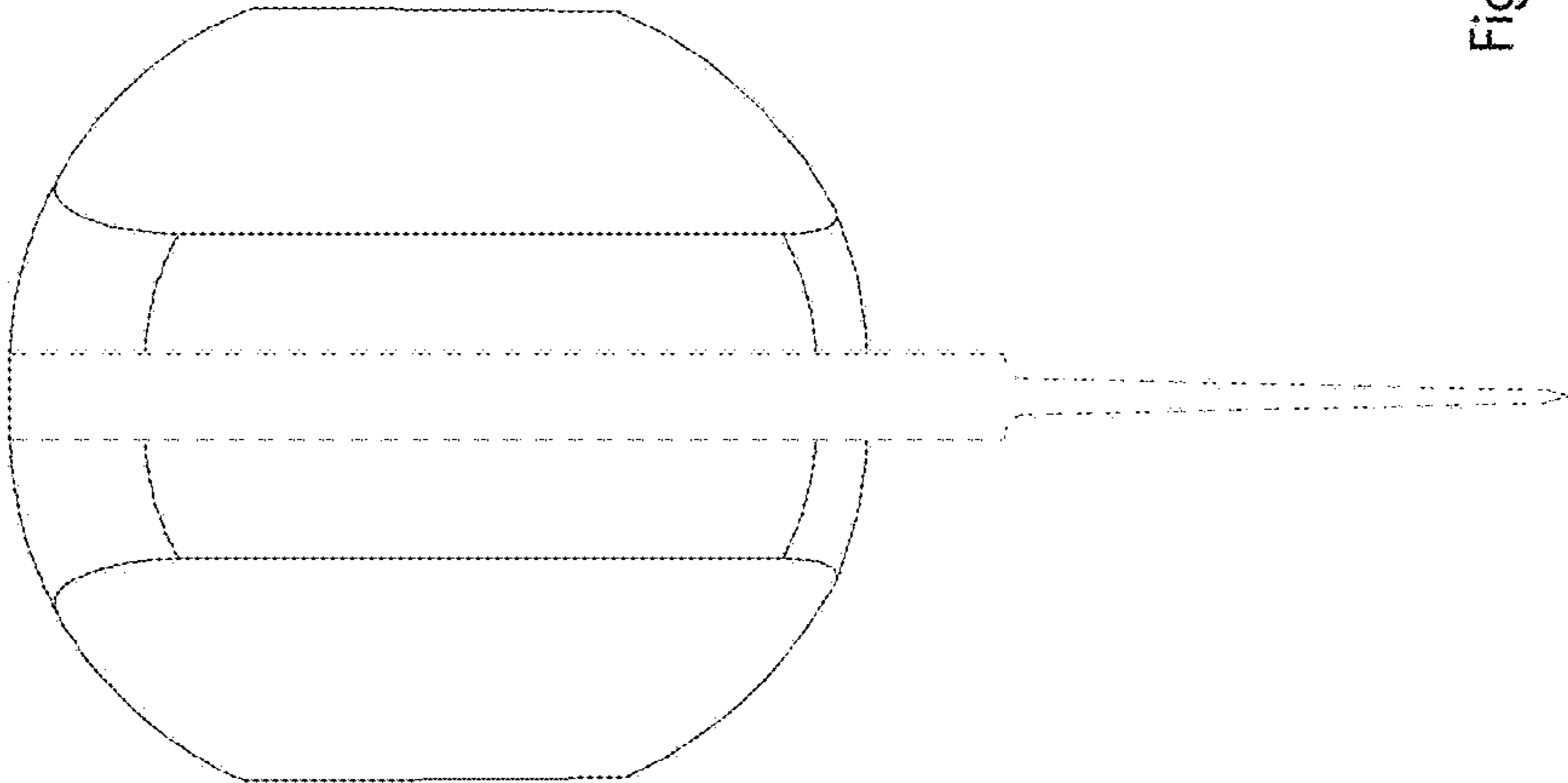

Fig. 6

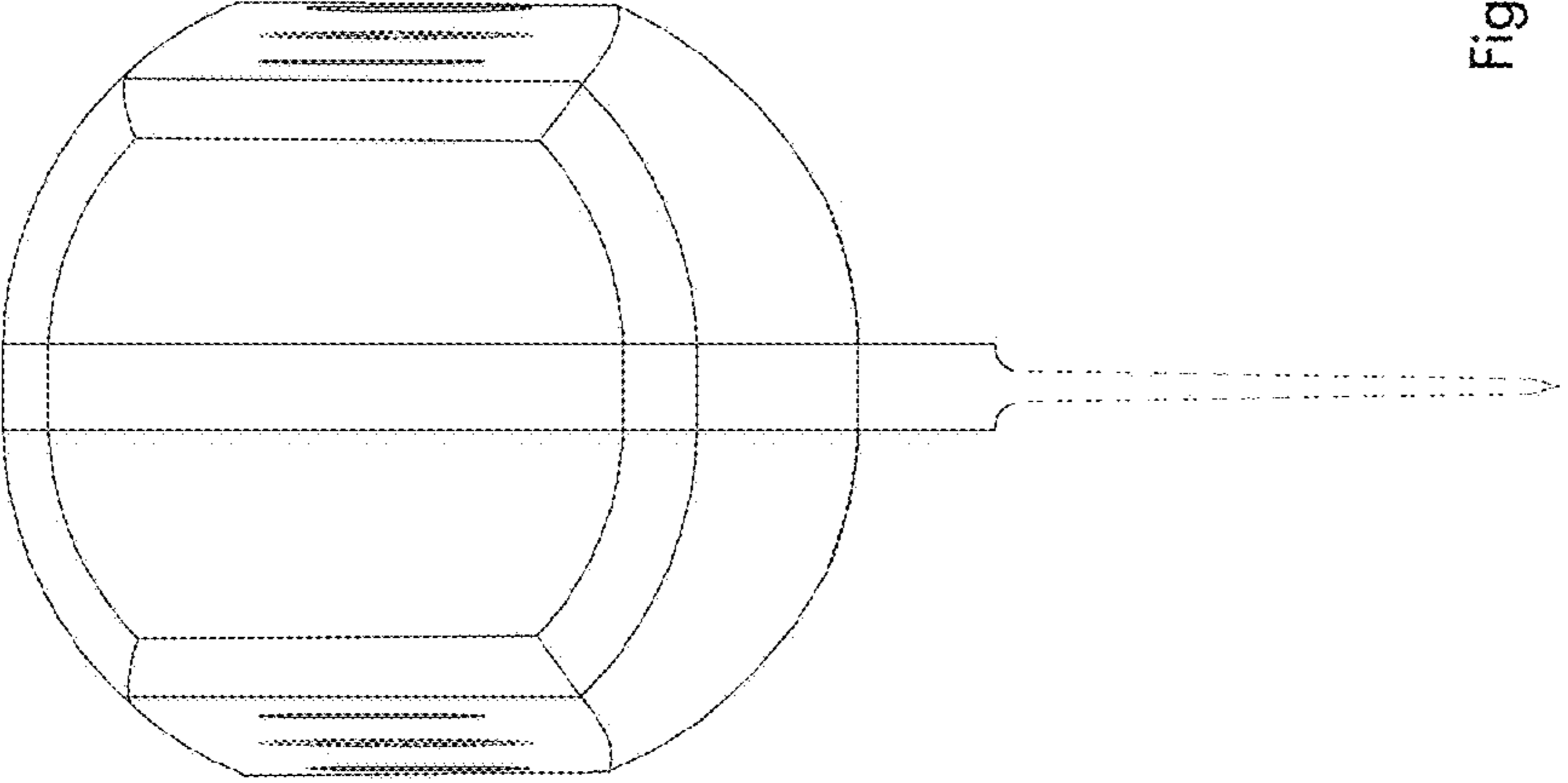

Fig. 5