



US00D838055S

(12) **United States Design Patent**
Villarreal

(10) **Patent No.:** **US D838,055 S**
(45) **Date of Patent:** **** Jan. 8, 2019**

(54) **PET SHELTER**

(71) Applicant: **Margarita C. Villarreal**, Floresville,
TX (US)

(72) Inventor: **Margarita C. Villarreal**, Floresville,
TX (US)

(**) Term: **15 Years**

(21) Appl. No.: **29/554,764**

(22) Filed: **Feb. 15, 2016**

(51) **LOC (11) Cl.** **30-02**

(52) **U.S. Cl.**
USPC **D30/108**

(58) **Field of Classification Search**

USPC D30/108, 109, 113, 114, 115, 117, 118,
D30/199; D3/213-217, 273, 276, 289,
D3/301, 242; D21/837, 834, 838, 839,
D21/253, 254; D25/13, 16-20, 26, 56
CPC A01K 1/00; A01K 31/22; A01K 31/17;
A01K 1/033; A01K 1/035; A01K 31/18;
A01K 1/0245; A01K 1/0353; A01K 1/03;
A01K 1/0254; A01K 31/08; E04H 15/40;
E04H 15/18; E04H 15/00; E04H 15/34;
E04B 1/32

See application file for complete search history.

(56) **References Cited**

U.S. PATENT DOCUMENTS

2,170,379	A	8/1939	Ortt	
2,516,869	A *	8/1950	Harris E04H 15/36 135/115
2,781,767	A	2/1957	Guy	
D232,850	S *	9/1974	Bloyd et al. D21/838
4,286,612	A	9/1981	Neal et al.	
D261,407	S *	10/1981	Moss D21/837
D285,880	S	9/1986	Griesenbeck	

(Continued)

OTHER PUBLICATIONS

Portable Folding Pet Tent, [online], [site visited Oct. 14, 2017].
Available from Internet, URL:https://www.aliexpress.com/item/
Portable-Folding-Pet-Dog-Cat-Tent-Cute-Dots-Pet-Tent-Outdoor-
Indoor-Tents-For-Kitten-Kennel/32806326651.html.*

(Continued)

Primary Examiner — Caron D Veynar

Assistant Examiner — Katrina N Gonzalez

(74) *Attorney, Agent, or Firm* — Vole & McElroy, LLP;
Michael D. Volk, Jr.

(57) **CLAIM**

The ornamental design for a pet shelter, as shown and
described.

DESCRIPTION

FIG. 1 is a perspective view of my design for a pet shelter.
FIG. 2 is a front view thereof.
FIG. 3 is a rear view thereof.
FIG. 4 is a top view thereof.
FIG. 5 is a bottom view thereof.
FIG. 6 is a left side view thereof, the right side view is the
same.
FIG. 7 is a rear perspective view shown in a collapsed
configuration.
FIG. 8 is a top view of the configuration shown in FIG. 7.
FIG. 9 is a bottom view of the configuration shown in FIG.
7.
FIG. 10 is a front view of the configuration shown in FIG.
7.
FIG. 11 is a rear view of the configuration shown in FIG. 7.
FIG. 12 is a left side view of the configuration shown in FIG.
7; and,
FIG. 13 is a right side view of the configuration shown in
FIG. 7.
My design for a pet shelter is flexible allowing it to collapse.

1 Claim, 6 Drawing Sheets

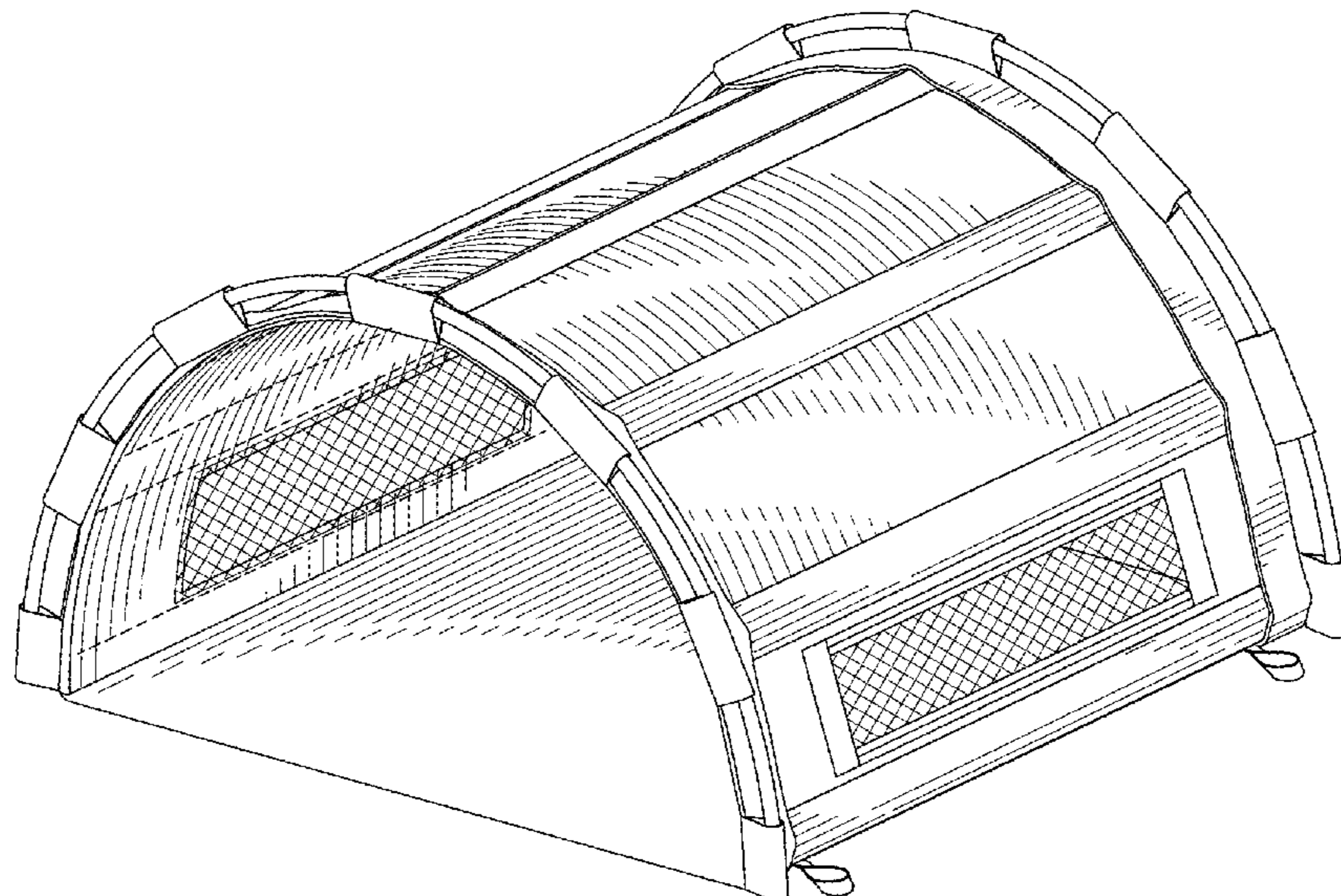

(56)

References Cited

U.S. PATENT DOCUMENTS

D287,041	S *	12/1986	Gitchel	D21/837
D288,613	S *	3/1987	James	D21/837
D294,752	S *	3/1988	Palier	119/28.5
D314,644	S *	2/1991	Kosharek	D30/118
D322,394	S *	12/1991	Grandesso	D30/112
D341,407	S *	11/1993	McLeese	D21/837
D373,658	S *	9/1996	Sierra	D30/108
5,823,217	A *	10/1998	Rice	E04H 15/003 135/124
D407,266	S *	3/1999	Silva	D30/108
D412,354	S *	7/1999	Takos	D21/837
D432,738	S *	10/2000	Mueller	D30/108
6,167,898	B1 *	1/2001	Larga	E04H 15/20 135/124
D441,040	S *	4/2001	Cho	D21/705
6,216,638	B1	4/2001	Pivonka et al.		
D461,638	S	8/2002	Kellogg et al.		
D468,872	S *	1/2003	Woehler	D30/108
D484,610	S *	12/2003	Lockwood	D25/1
6,715,446	B2	4/2004	Chou		
D490,533	S *	5/2004	Lockwood	D25/1
D501,063	S *	1/2005	Bertoli	D30/108
D511,027	S *	10/2005	Mueller	D30/108
D629,973	S *	12/2010	Morton	D30/108
D661,362	S *	6/2012	Zimmer	D21/834
2005/0229866	A1	10/2005	Simpson et al.		
2007/0227571	A1	10/2007	Youn		
2010/0242856	A1	9/2010	Willard		
2012/0240970	A1 *	9/2012	Parsons	E04H 15/425 135/126
2013/0180463	A1	7/2013	Messner		
2013/0333737	A1 *	12/2013	Williams	E04H 15/18 135/97

OTHER PUBLICATIONS

Altteuri, One-Touch Portable Folding large Dog House tent for indoor,outdoor waterproof, Amazon.com, date of publication unknown (available at http://www.amazon.com/One-Touch-Portable-Folding-outdoor-waterproof/dp/B00UH0899W/ref=sr_1_1?ie=UTF8&qid=1455201748&sr=8-1&keywords=one+touch+portable+folding).

Chimaera, Chimaera Foldable Pop Up Beach Tent Shelter, Amazon.com, date of publication unknown (available at http://www.amazon.com/CHIMAERA-Foldable-Beach-Tent-Shelter/dp/B00V93B3TY/ref=sr_1_14?ie=UTF8&qid=1455202136&sr=8-14&keywords=pop-up+portable+and+foldable+tent).

Ewonderworld, Portable Pet Shade Shelter Outdoor Dog Tent: Extra Large w/ Storage Pockets, Amazon.com, Date of publication unknown (available at <http://www.amazon.com/Portable-Shade-Shelter-Outdoor->

[Tent/dp/B00P1ASRWM/ref=sr_1_1?ie=UTF8&qid=1455201922&sr=8-1&keywords=portable+pet+shade+shelter](http://www.amazon.com/Tent/dp/B00P1ASRWM/ref=sr_1_1?ie=UTF8&qid=1455201922&sr=8-1&keywords=portable+pet+shade+shelter)).

GVGS Shop, 1Pcs Splendid Popular Pet Tent House Cat Beach Shelter Puppy Outdoor Camp Sleeping Couch Color Black, Amazon.com, date of publication unknown (available at http://www.amazon.com/Splendid-Popular-Shelter-Outdoor-Sleeping/dp/B013KLU528/ref=sr_1_1?ie=UTF8&qid=1455202937&sr=8-1&keywords=splendid+popular+pet+tent).

Kyjen, Outward Hound Kyjen 2546 Shade Shelter Pet Tent Outdoor Dog Shelter, Extra Large, Green, Amazon.com, date of publication unknown (available at http://www.amazon.com/Outward-Kyjen-2546-Shelter-Outdoor/dp/B008GP8100/ref=sr_1_1?ie=UTF8&qid=1455203046&sr=8-1&keywords=outward).

Lucy's Beach House, Pop Up Portable Pet Tent—Large (31"×31"×31"), Amazon.com, date of publication unknown (available at http://www.amazon.com/POP-UP-PORTABLE-PET-TENT/dp/B007V5ANH2/ref=sr_1_2?ie=UTF8&qid=1455202649&sr=8-2&keywords=pop+up+portable+pet+tent).

MPet, Large Blue Portable Pet Soft Crate/Carrier for Travel, Indoor/Outdoor *28"L×21"W×21"H, Amazon.com, date of publication unknown (available at http://www.amazon.com/Portable-Carrier-Travel-Indoor-Outdoor/dp/B002N7RT7A/ref=sr_1_4?ie=UTF8&qid=1455202425&sr=8-4&keywords=large+blue+portable+soft+sided).

MTN Gearsmith, New Large Dog Pet Puppy Portable Foldable Soft Crate Playpen Kennel House—Blue Red Green, Amazon.com, date of publication unknown (available at http://www.amazon.com/Portable-Foldable-Playpen-Kennel--Green/dp/B00EKW3W8Q/ref=sr_1_9?ie=UTF8&qid=1455202189&sr=8-9&keywords=portable+playpen+kennel+foldable).

Sport Pet Designs, Pop Open Dog Kennel for Pets up to 25 Lbs. 15"W ×15"H ×26"D Assorted Colors, Amazon.com, date of publication unknown (available at http://www.amazon.com/Sport-Pet-Designs-Kennel-Small/dp/B0072NPTGI/ref=sr_1_3?ie=UTF8&qid=1455203276&sr=8-3&keywords=pop+open+dog+kenneltward+hound+pet+tent).

Uxcell, Uxcell Paw Pattern Pet Tent Doghouse Nest, 40cm, Red, Amazon.com, date of publication unknown (available at http://www.amazon.com/Uxcell-Pattern-Tent-Doghouse-Nest/dp/B00ZRHO44O/ref=sr_1_3?ie=UTF8&qid=1455202763&sr=8-3&keywords=uxcell+p).

Vedem, Vedem Pets Portable Sun Shelter Tent House, Amazon.com, date of publication unknown (available at http://www.amazon.com/Vedem-Pets-Portable-Shelter-House/dp/B00JTTM4IE/ref=sr_1_1?ie=UTF8&qid=1455202299&sr=8-1&keywords=vedem+tent+house).

Ware, Ware Manufacturing Twist-N-Go Kennel Dog Carrier, Amazon.com, date of publication unknown (available at http://www.amazon.com/Ware-Manufacturing-Twist-N-Go-Kennel-Large/dp/B001VJ1E8Q/ref=sr_1_2?ie=UTF8&qid=1455202546&sr=8-2&keywords=twist-n-go).

* cited by examiner

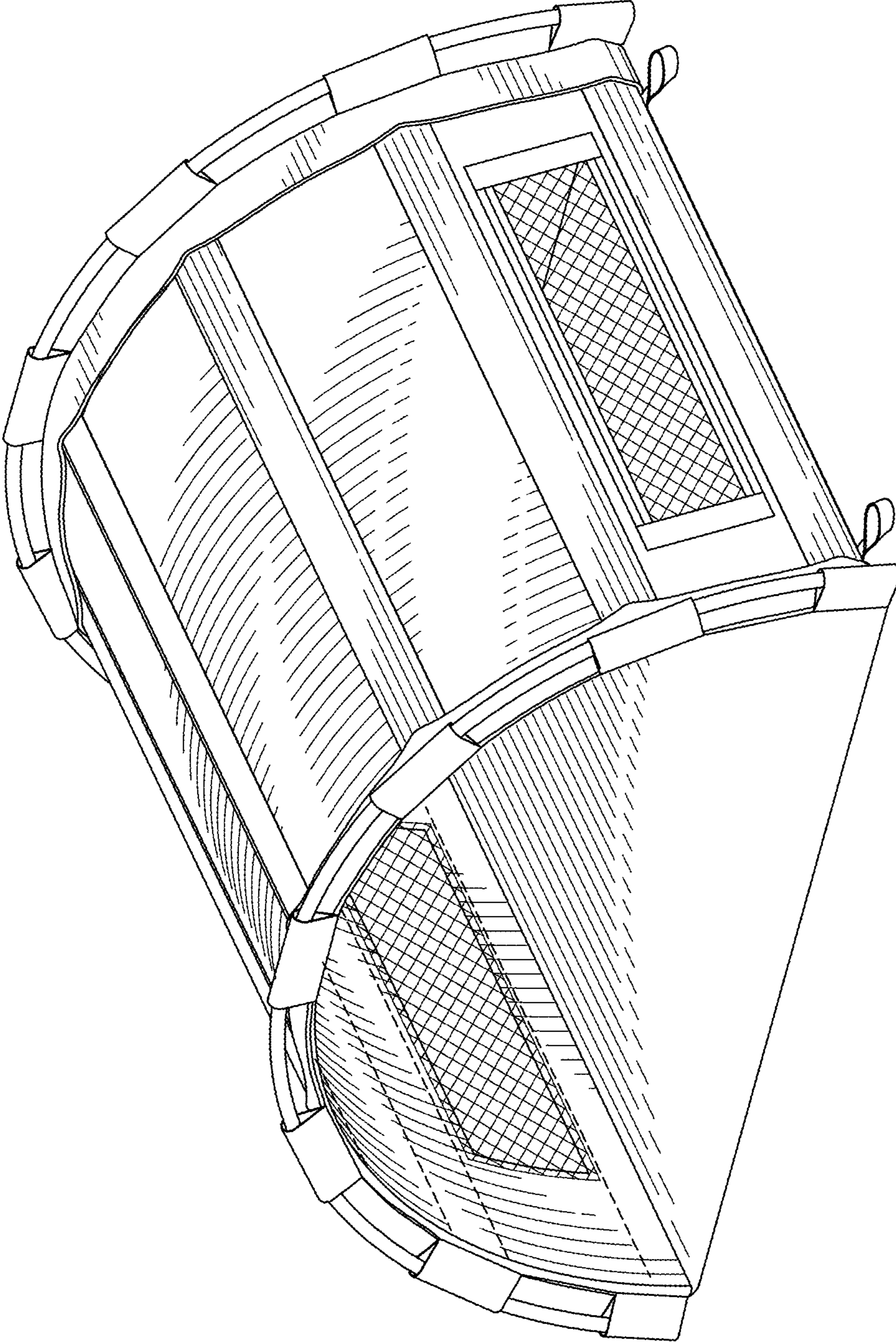

FIG. 1

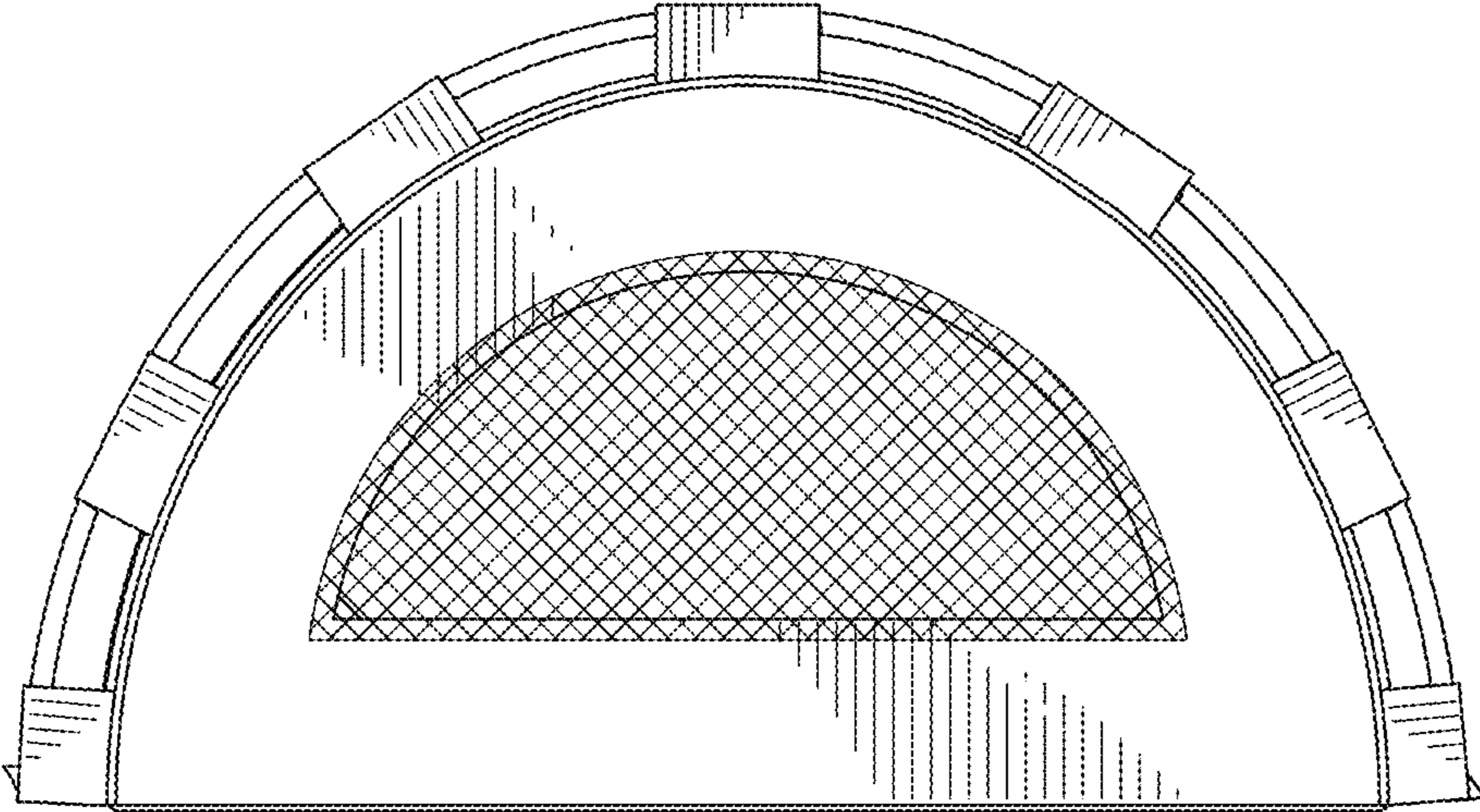

FIG. 2

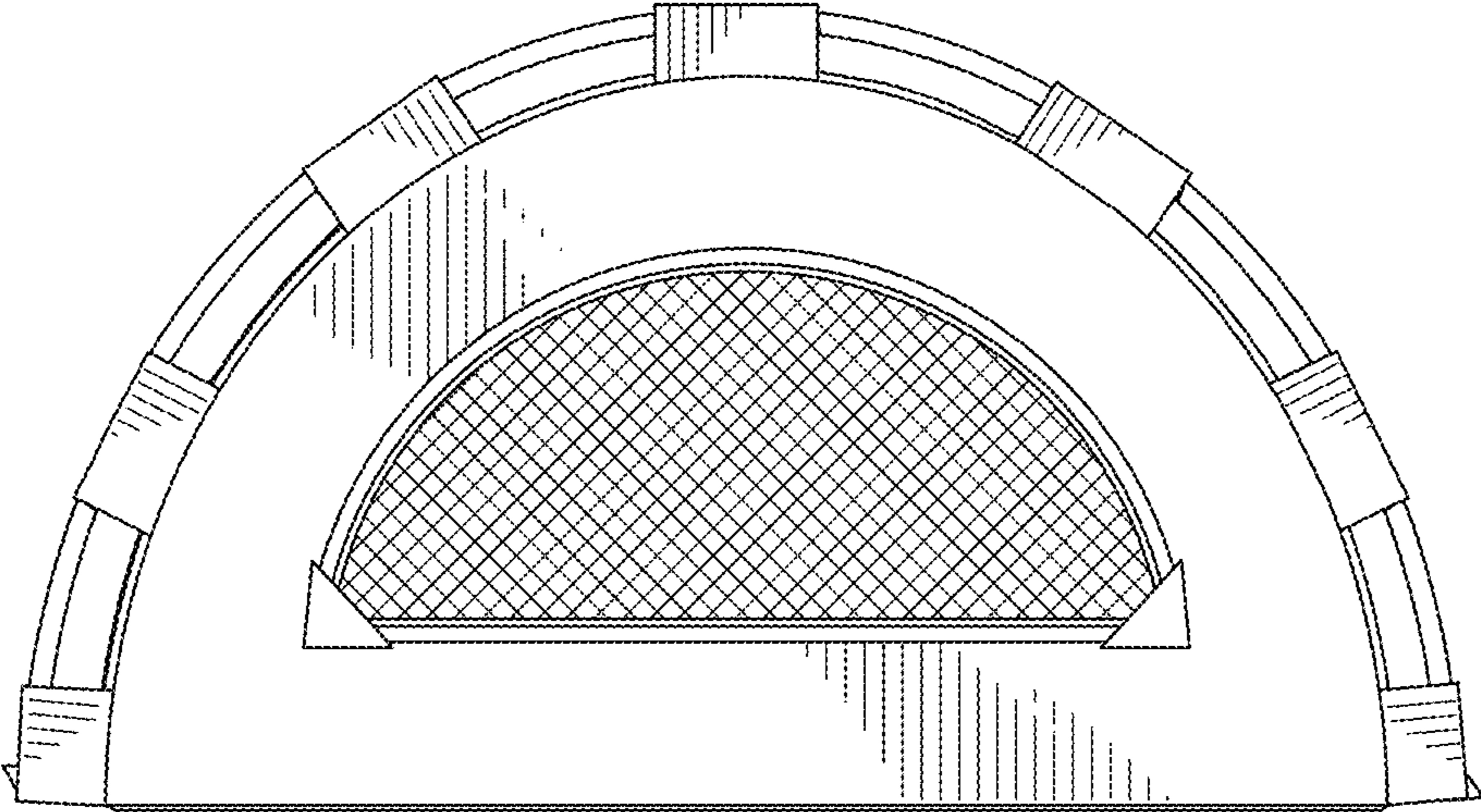

FIG. 3

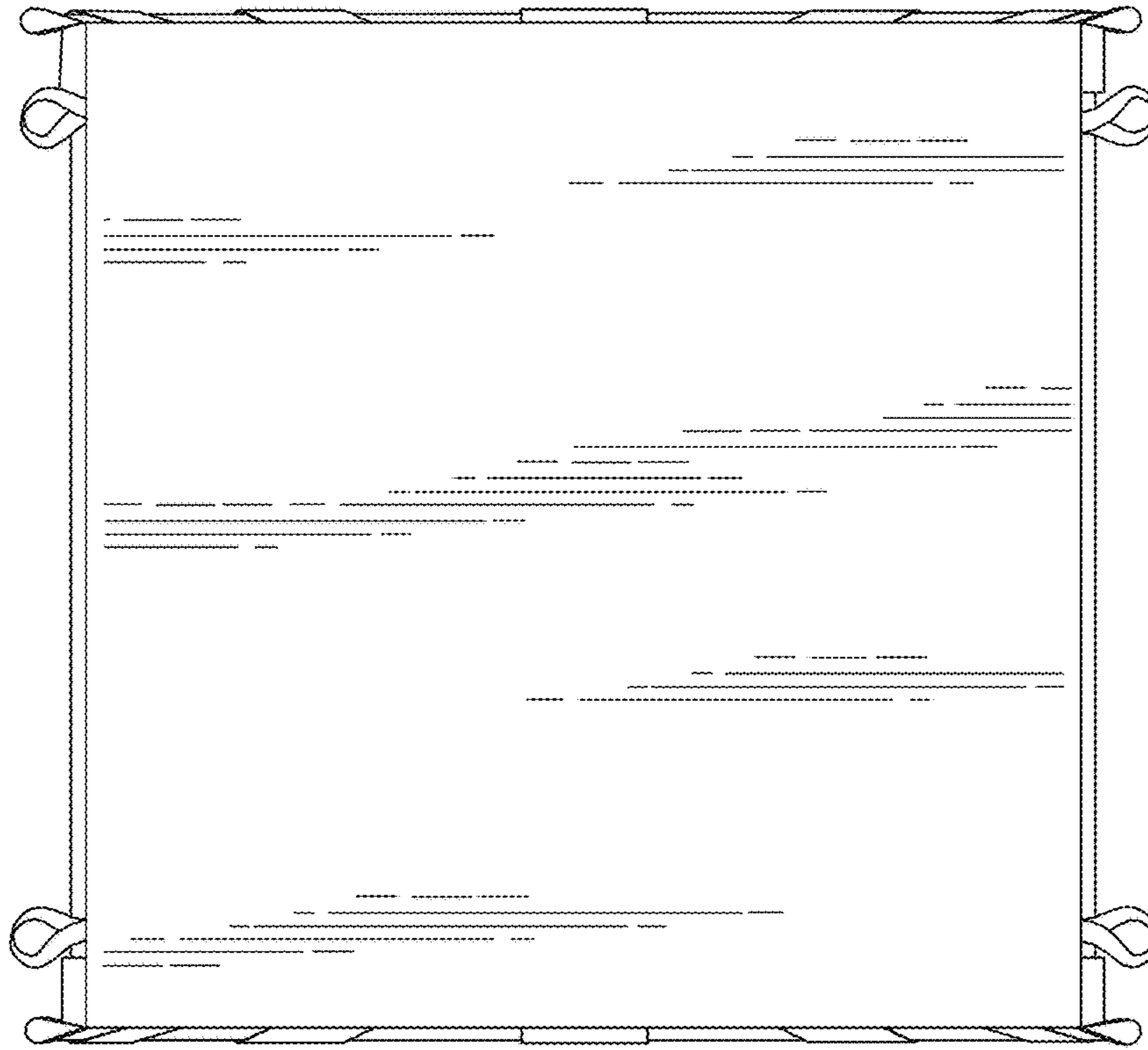

FIG. 5

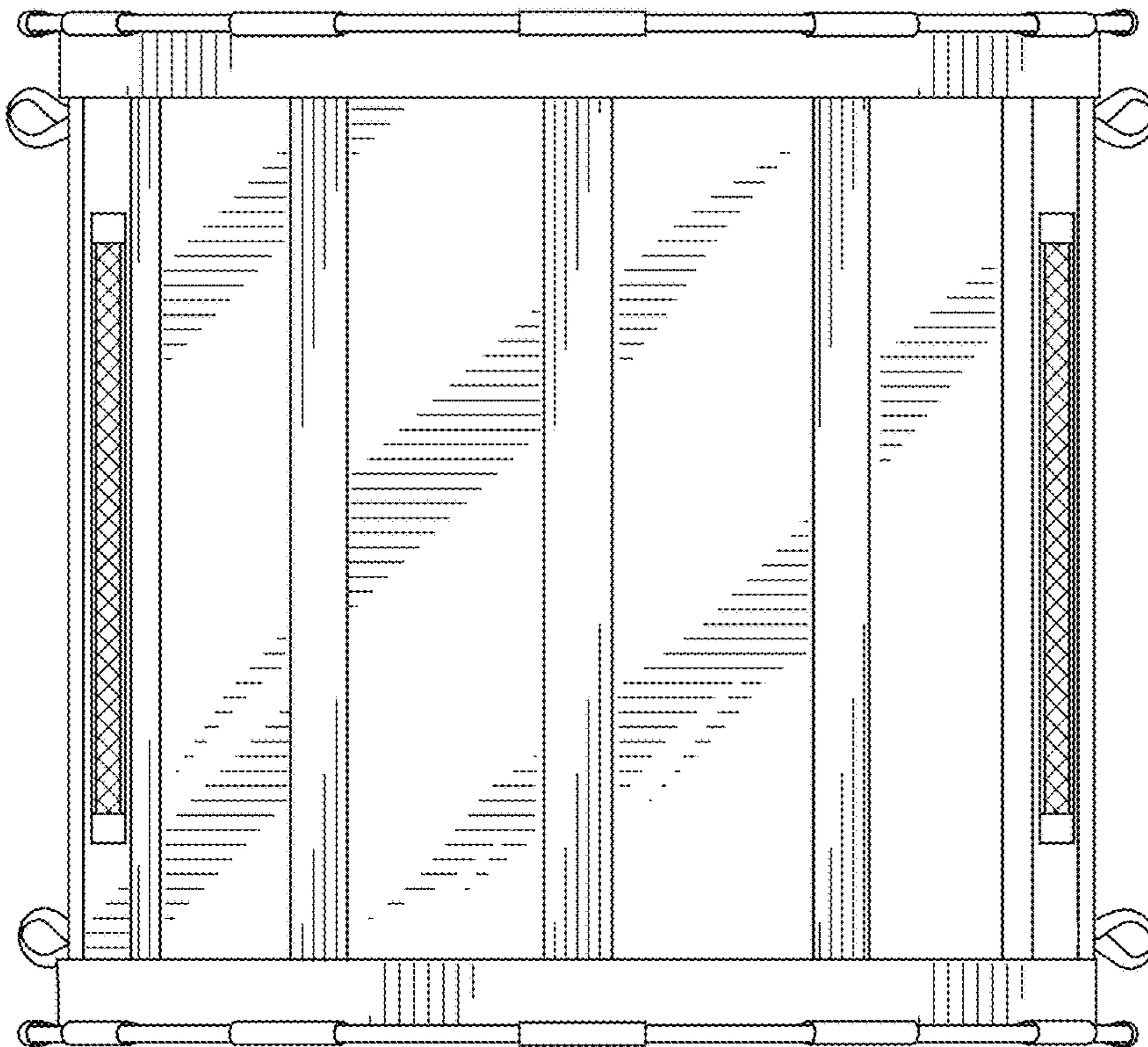

FIG. 4

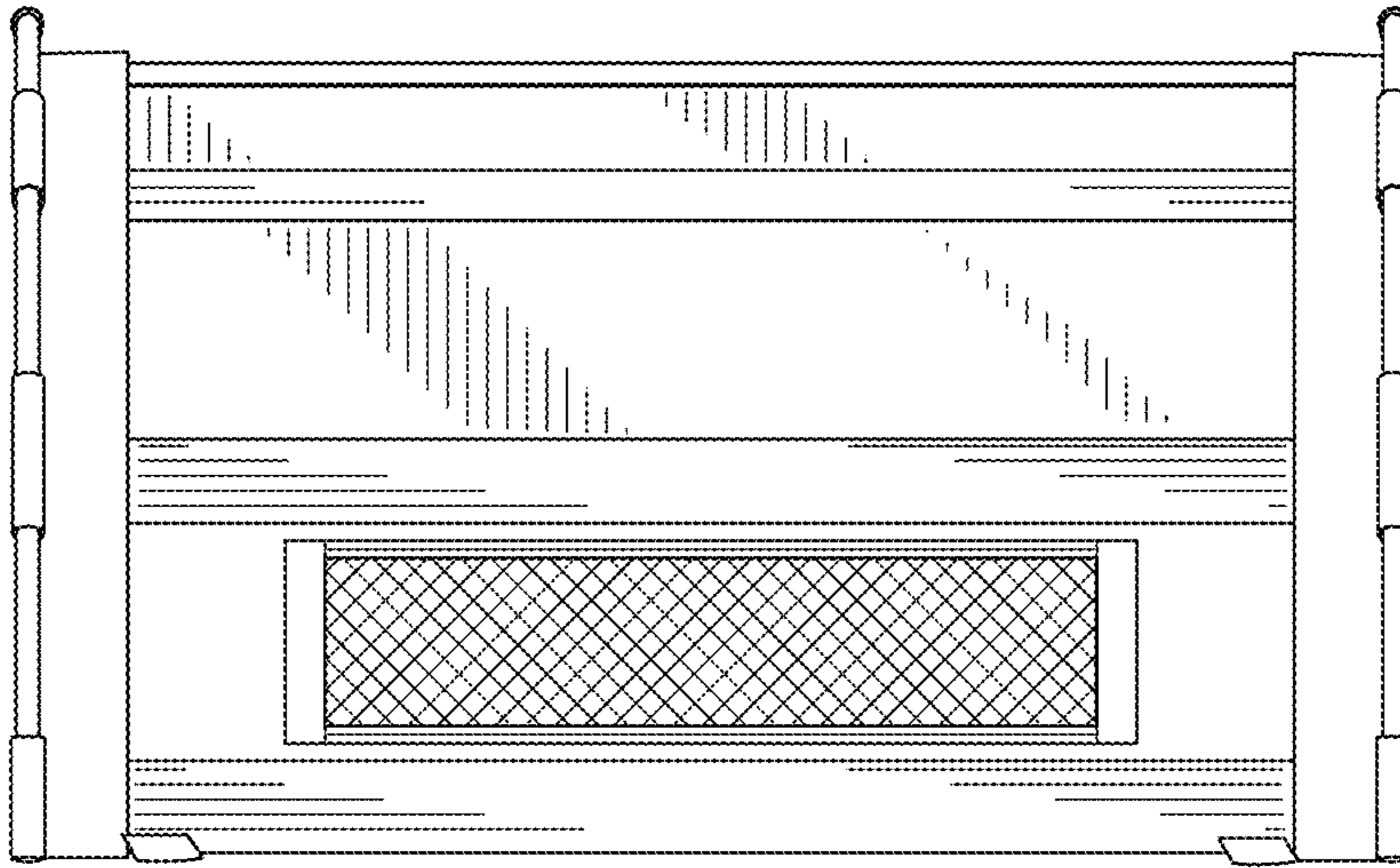

FIG. 6

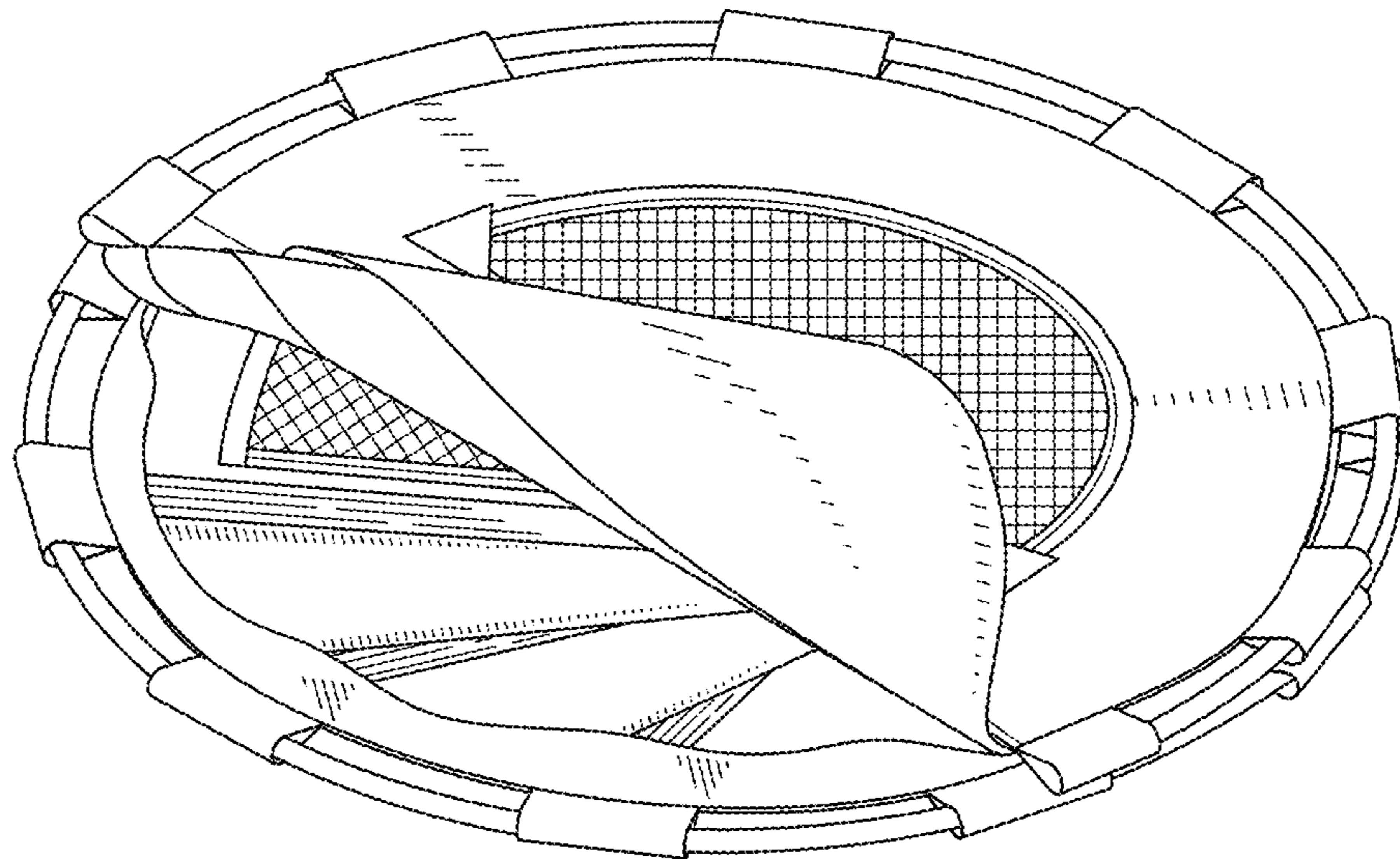

FIG. 7

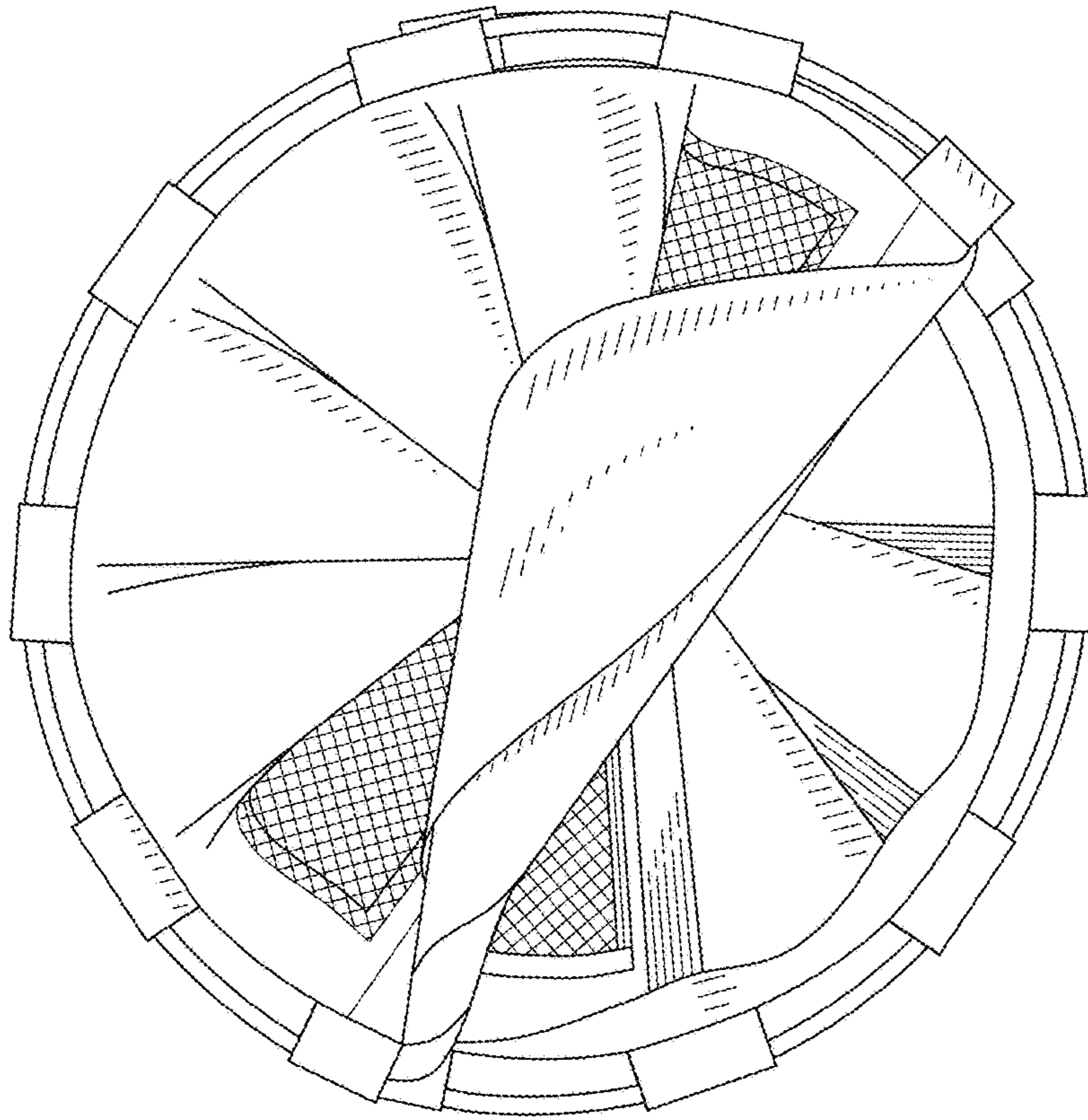

FIG. 9

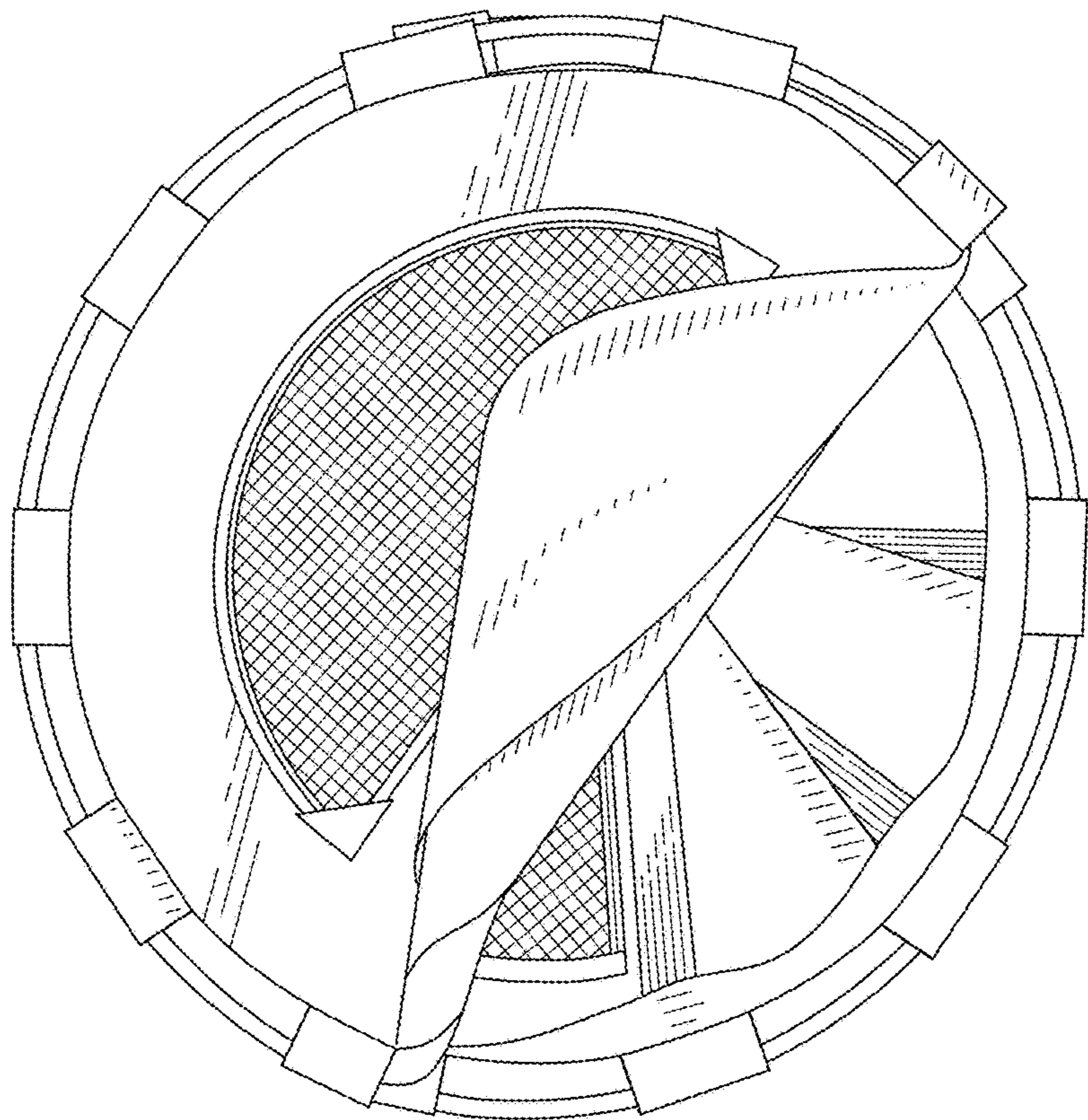

FIG. 8

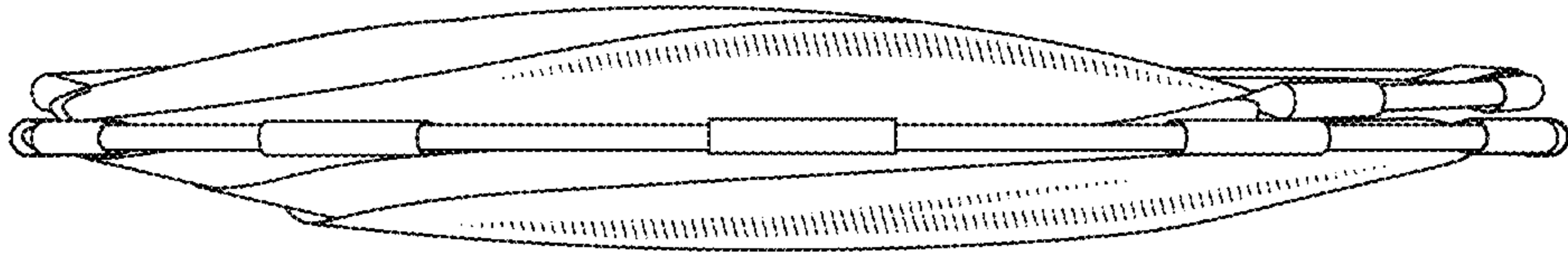

FIG. 10

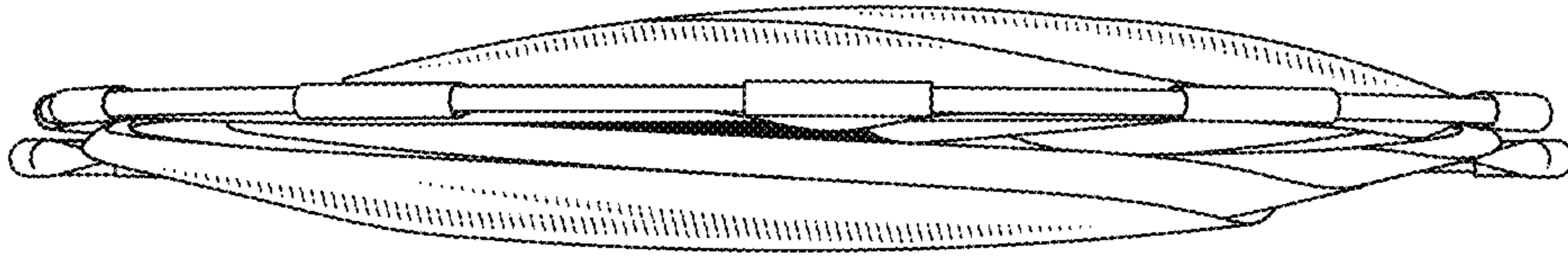

FIG. 11

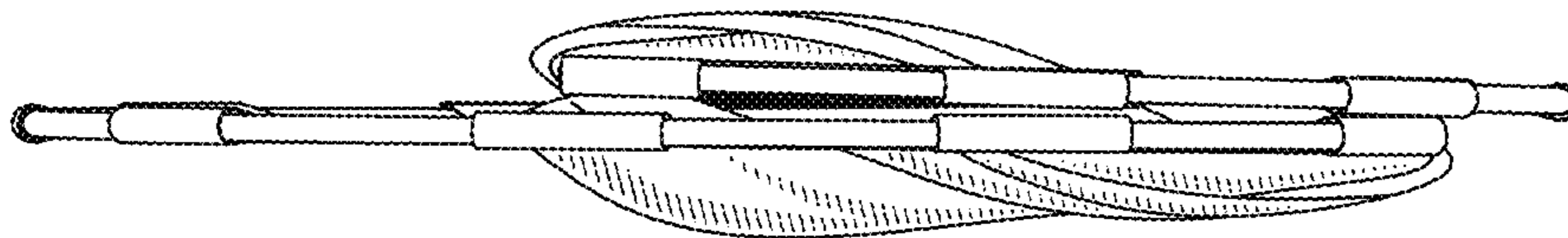

FIG. 12

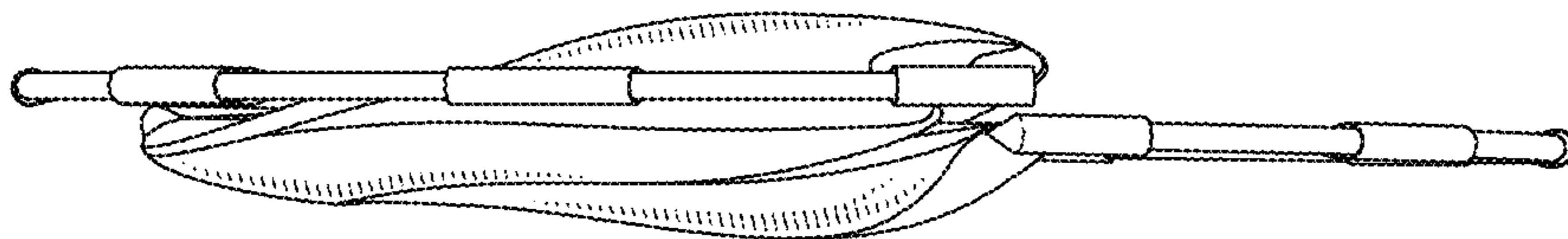

FIG. 13