



US00D838051S

(12) **United States Design Patent**
Campanella

(10) **Patent No.:** **US D838,051 S**

(45) **Date of Patent:** **** Jan. 8, 2019**

(54) **MOUTHGUARD**

(71) Applicant: **Federico Campanella**, Turin (IT)

(72) Inventor: **Federico Campanella**, Turin (IT)

(**) Term: **15 Years**

(21) Appl. No.: **35/503,781**

(22) Filed: **Jul. 20, 2017**

(80) **Hague Agreement Data**

Int. Filing Date: **Jul. 20, 2017**

Int. Reg. No.: **DM/097762**

Int. Reg. Date: **Jul. 20, 2017**

Int. Reg. Pub. Date: **Oct. 6, 2017**

(51) **LOC (11) Cl.** **29-02**

(52) **U.S. Cl.**
USPC **D29/108**

(58) **Field of Classification Search**
USPC D24/180; D29/108
CPC . A61F 5/566; A63B 71/085; A63B 2071/086;
A63B 2071/088; A61C 7/10; A61C
19/063; A61C 19/066
See application file for complete search history.

(56) **References Cited**

U.S. PATENT DOCUMENTS

8,590,538 B2 * 11/2013 Croll A63B 71/085
128/859
D739,028 S * 9/2015 Stein D24/180
D743,109 S * 11/2015 Charlton D29/108
D760,441 S * 6/2016 Cody D29/108
D765,919 S * 9/2016 Croll D29/108

D771,876 S * 11/2016 Hazard D29/108
9,949,867 B2 * 4/2018 Veis A61F 5/566
2009/0165805 A1 * 7/2009 Syrop A61F 5/566
128/861
2012/0085354 A1 * 4/2012 Polk, III A63B 71/085
128/861

* cited by examiner

Primary Examiner — Robert M. Spear

(57) **CLAIM**

The ornamental design for a mouthguard, as shown and described.

DESCRIPTION

The patent or application file contains at least one drawing executed in color. Copies of this patent or patent application publication with color drawing(s) will be provided by the Office upon request and payment of the necessary fee.

- 1.-2. Mouthguards
- 1.1 : Perspective (front, top, right) view
- 1.2 : Perspective (front, bottom, right) view
- 1.3 : Front
- 1.4 : Bottom
- 1.5 : Back
- 1.6 : Right vertical view
- 1.7 : Left vertical view
- 2.1 : Perspective (front, top, right) view
- 2.2 : Perspective (front, bottom, right) view
- 2.3 : Front
- 2.4 : Bottom
- 2.5 : Back view upside down
- 2.6 : Right vertical view
- 2.7 : Left vertical view

1 Claim, 14 Drawing Sheets
(14 of 14 Drawing Sheet(s) Filed in Color)

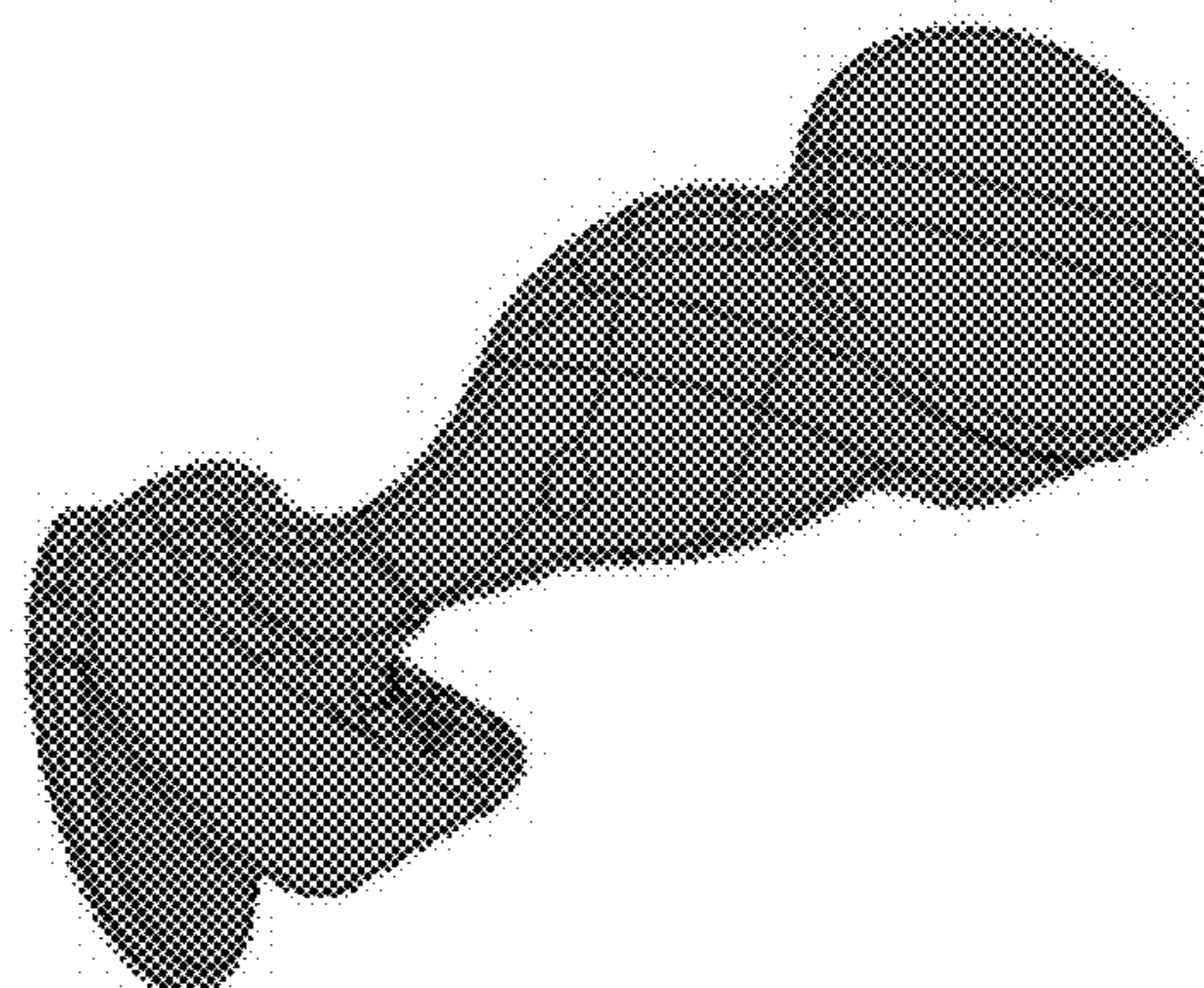
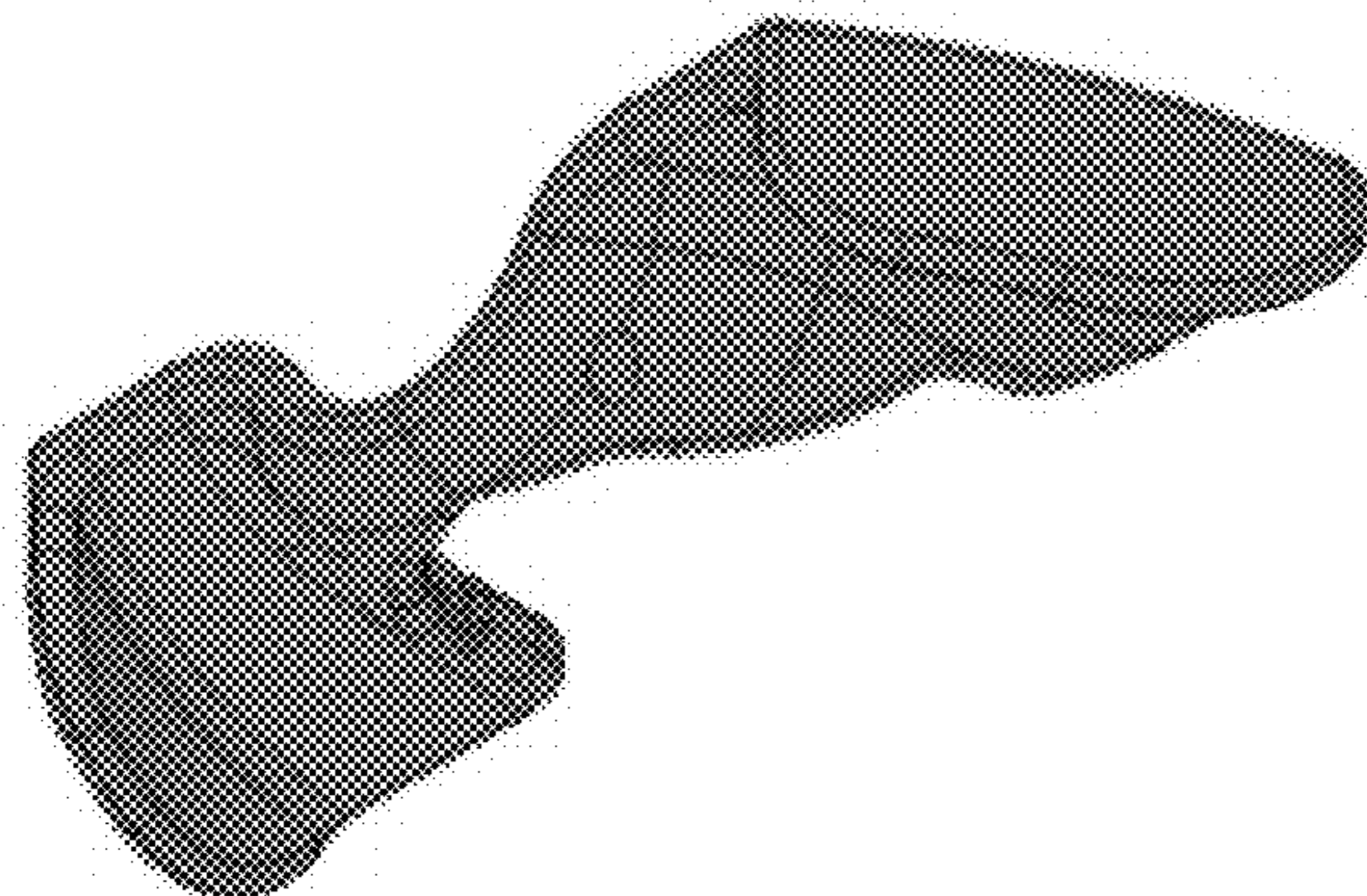

1.1

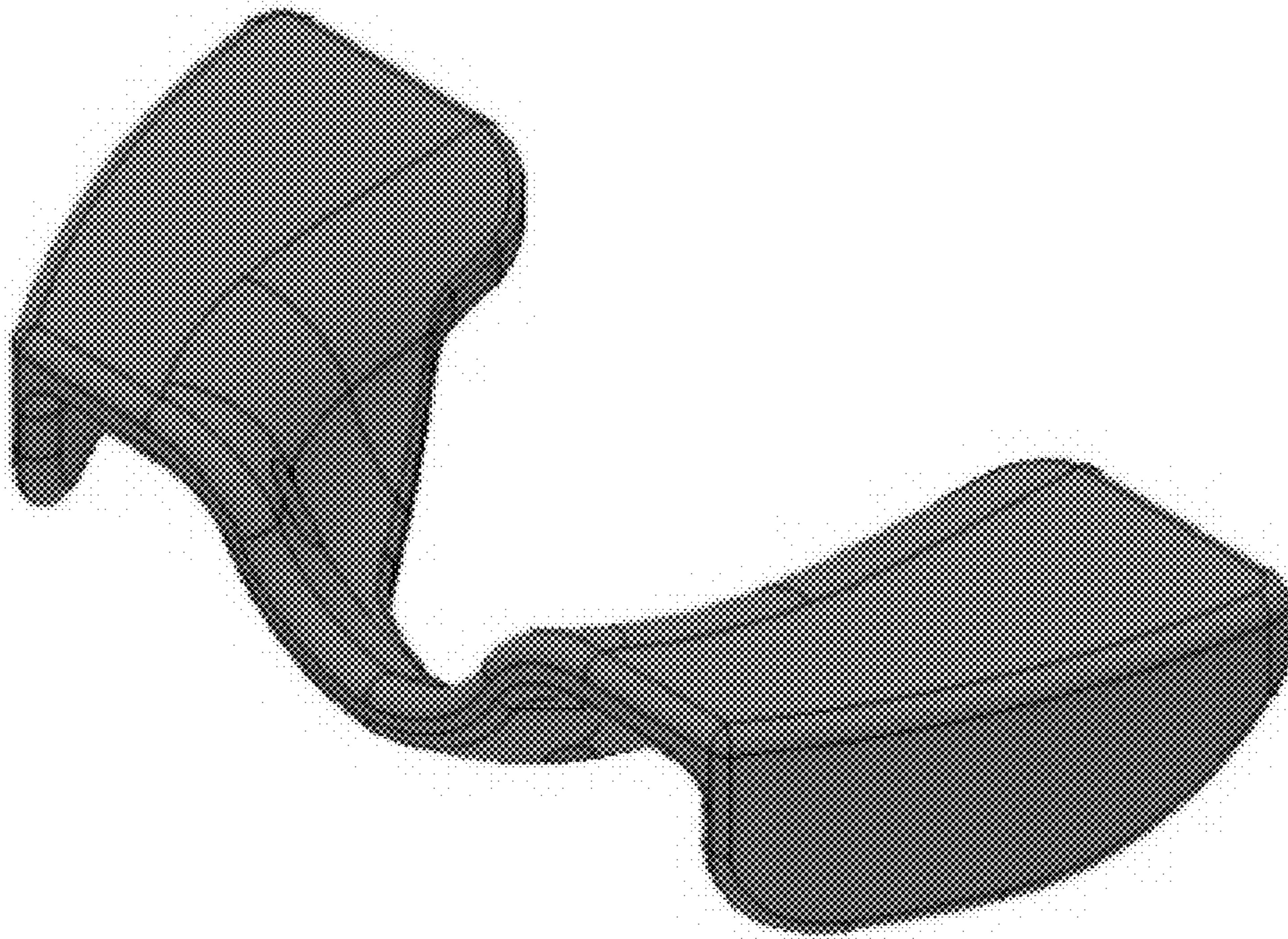

1.2

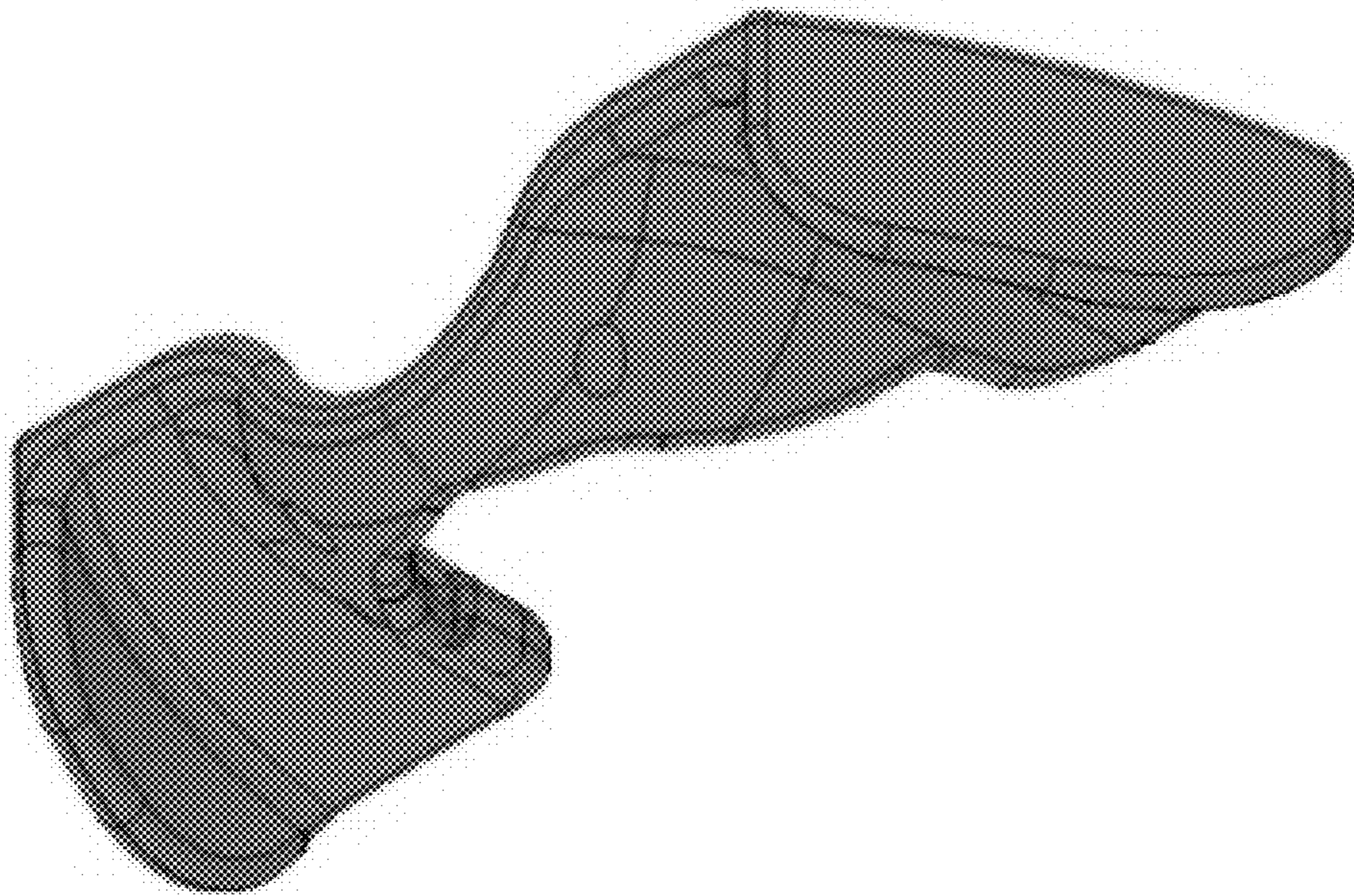

1.3

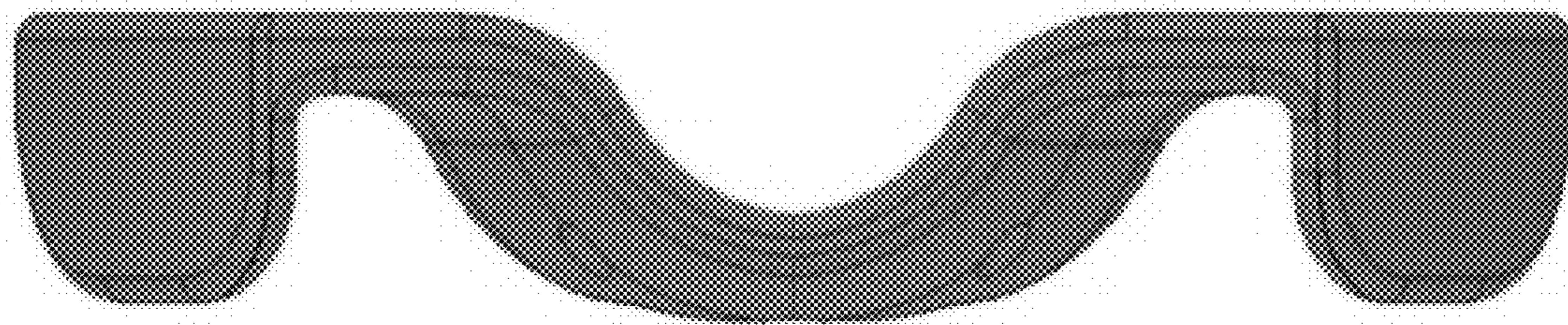

1.4

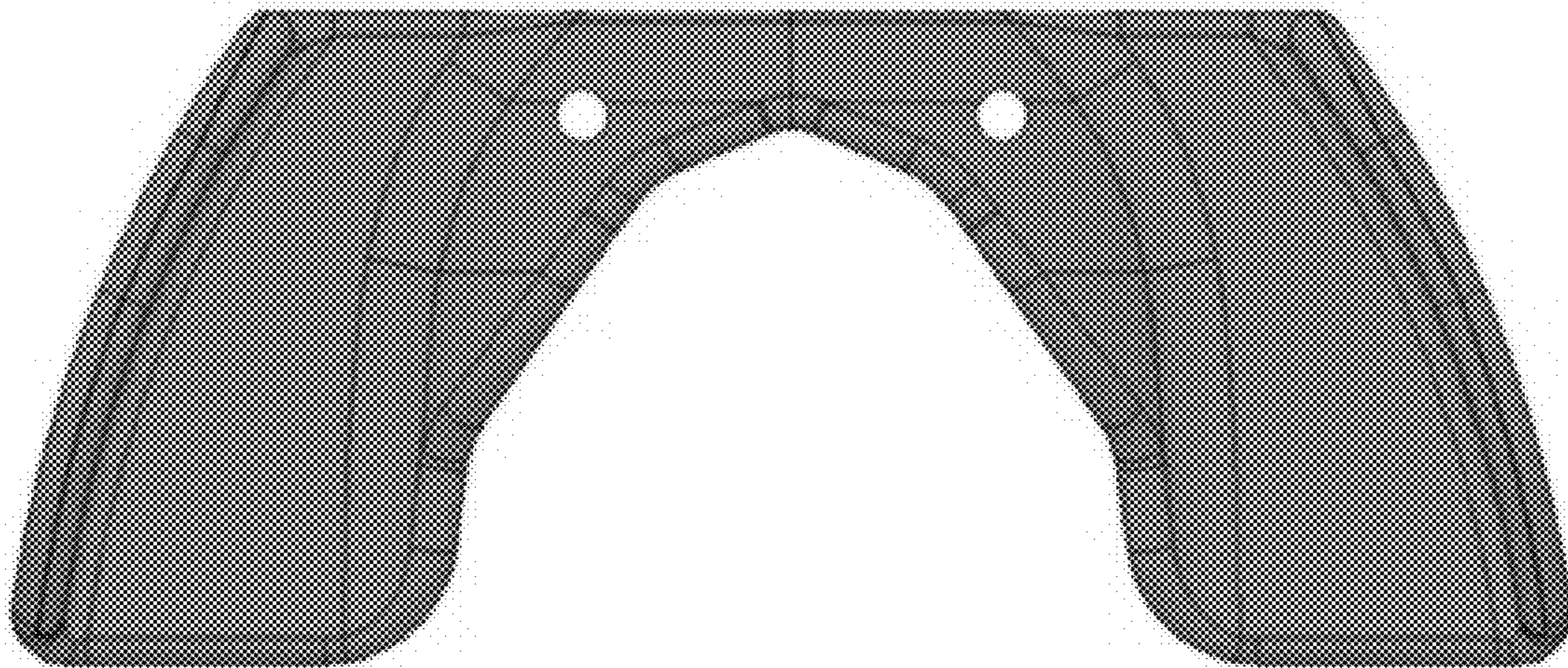

1.5

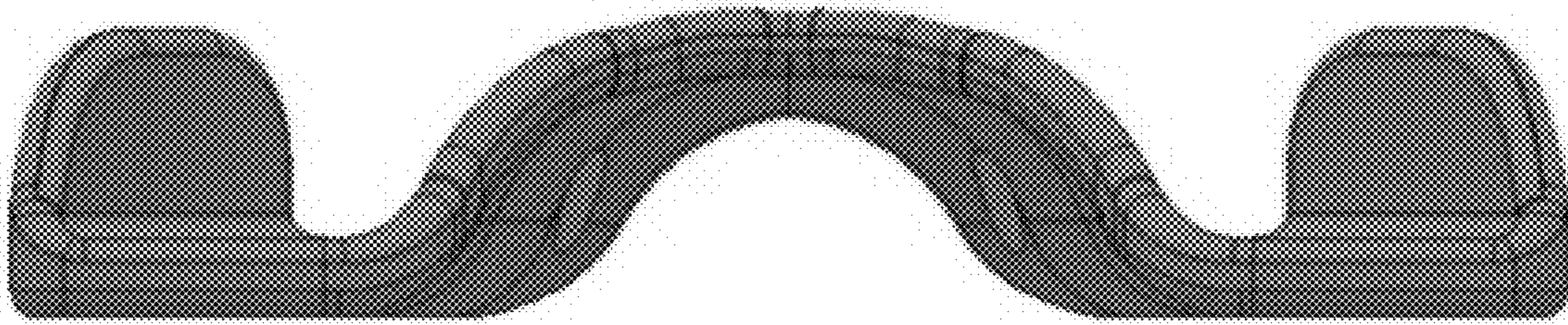

1.6

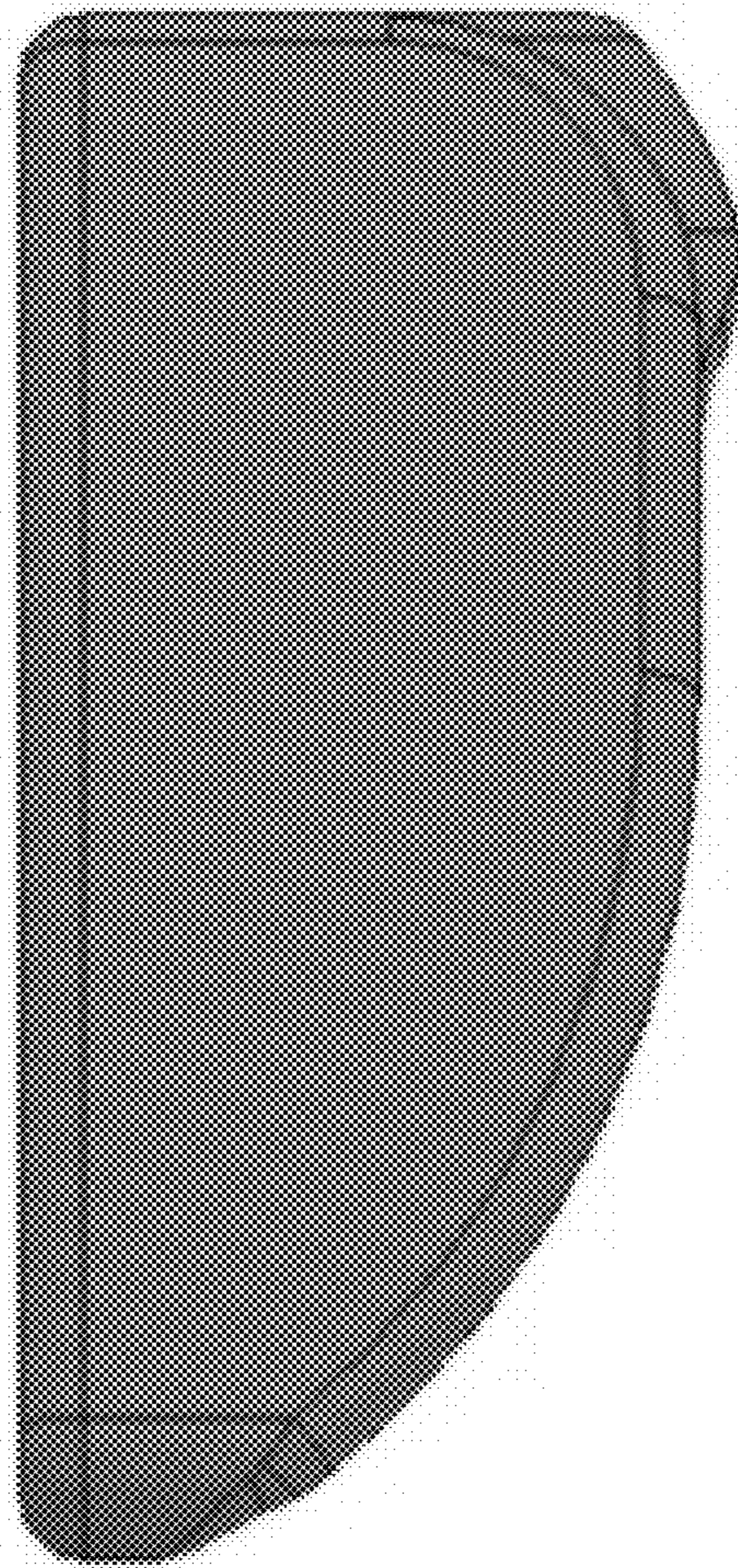

1.7

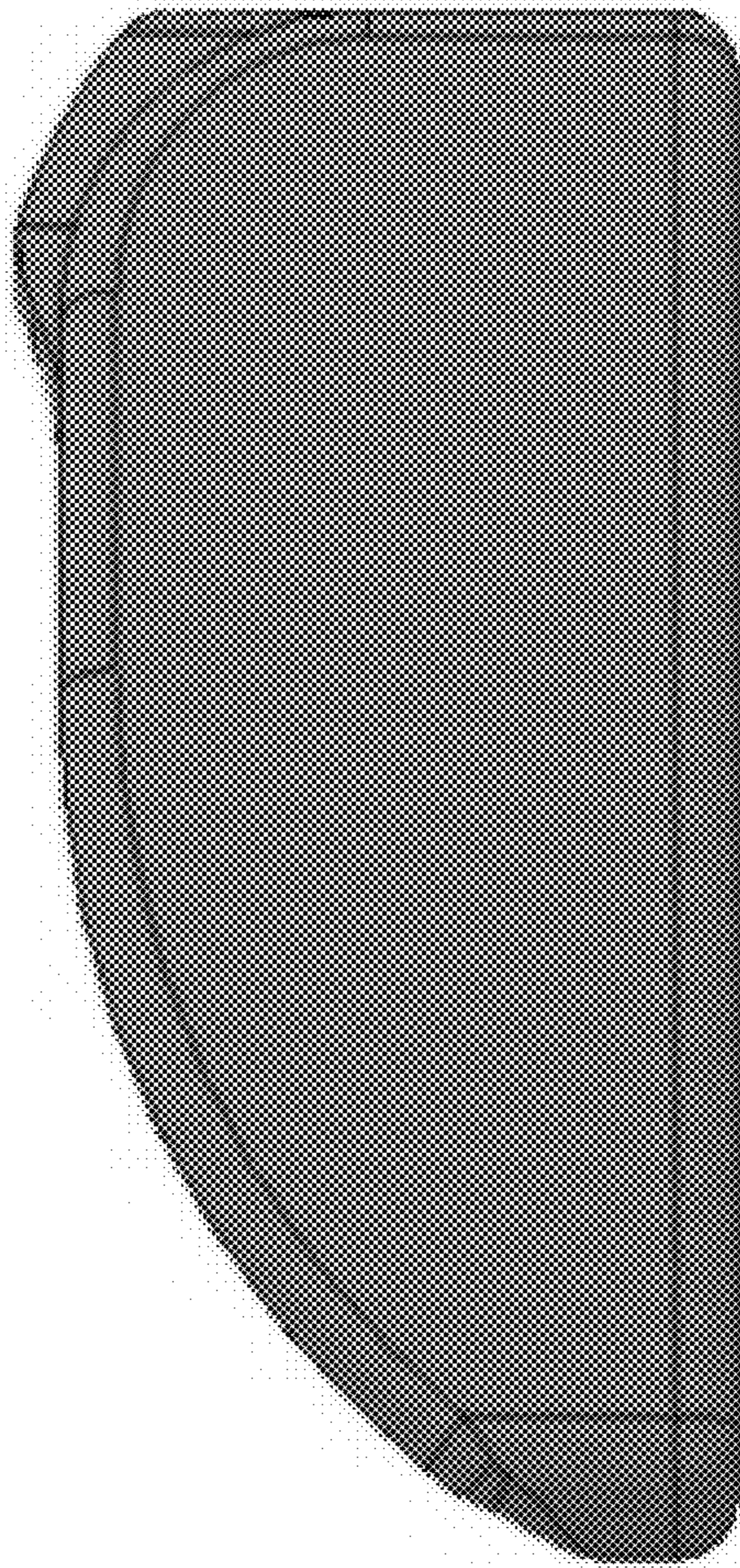

2.1

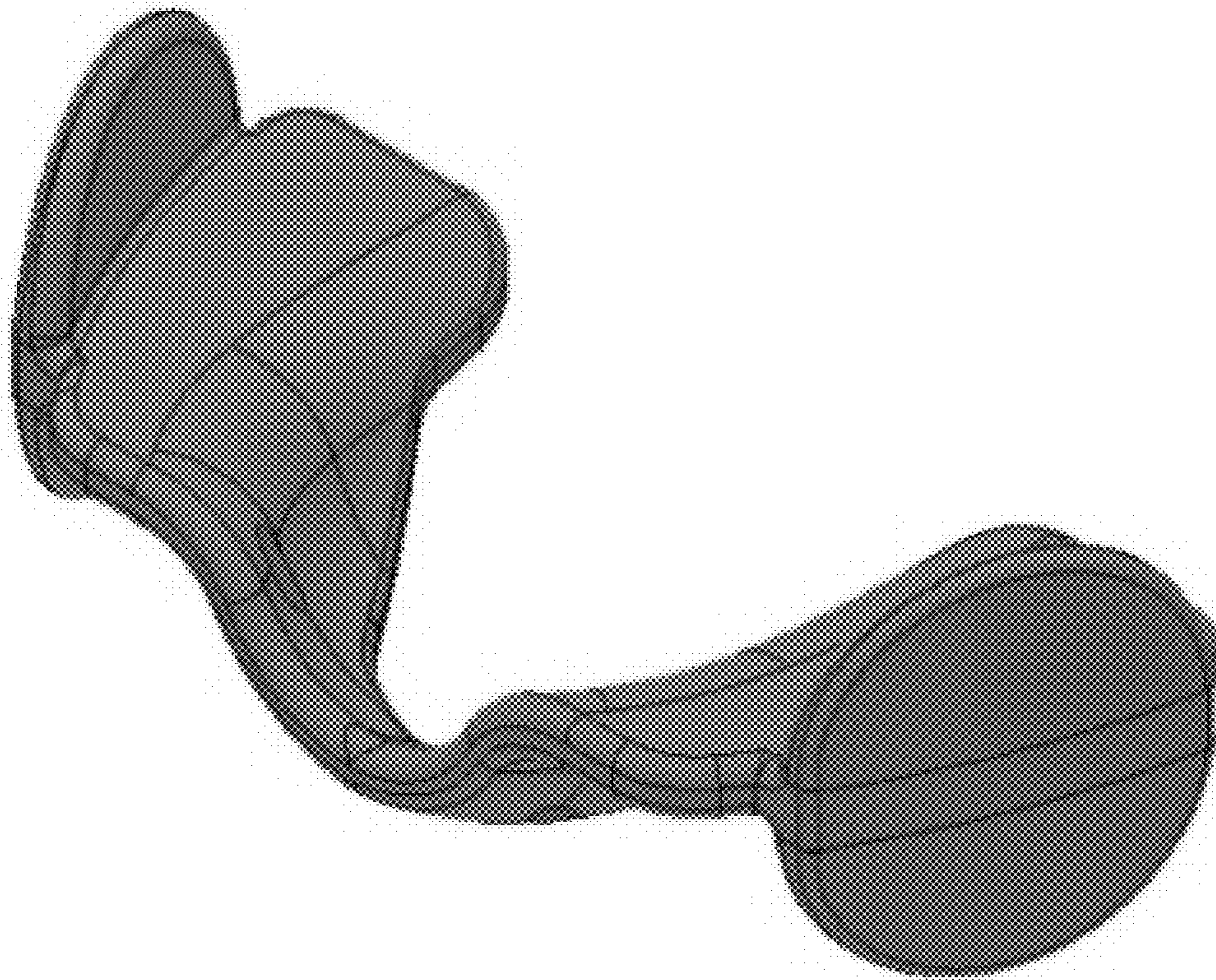

2.2

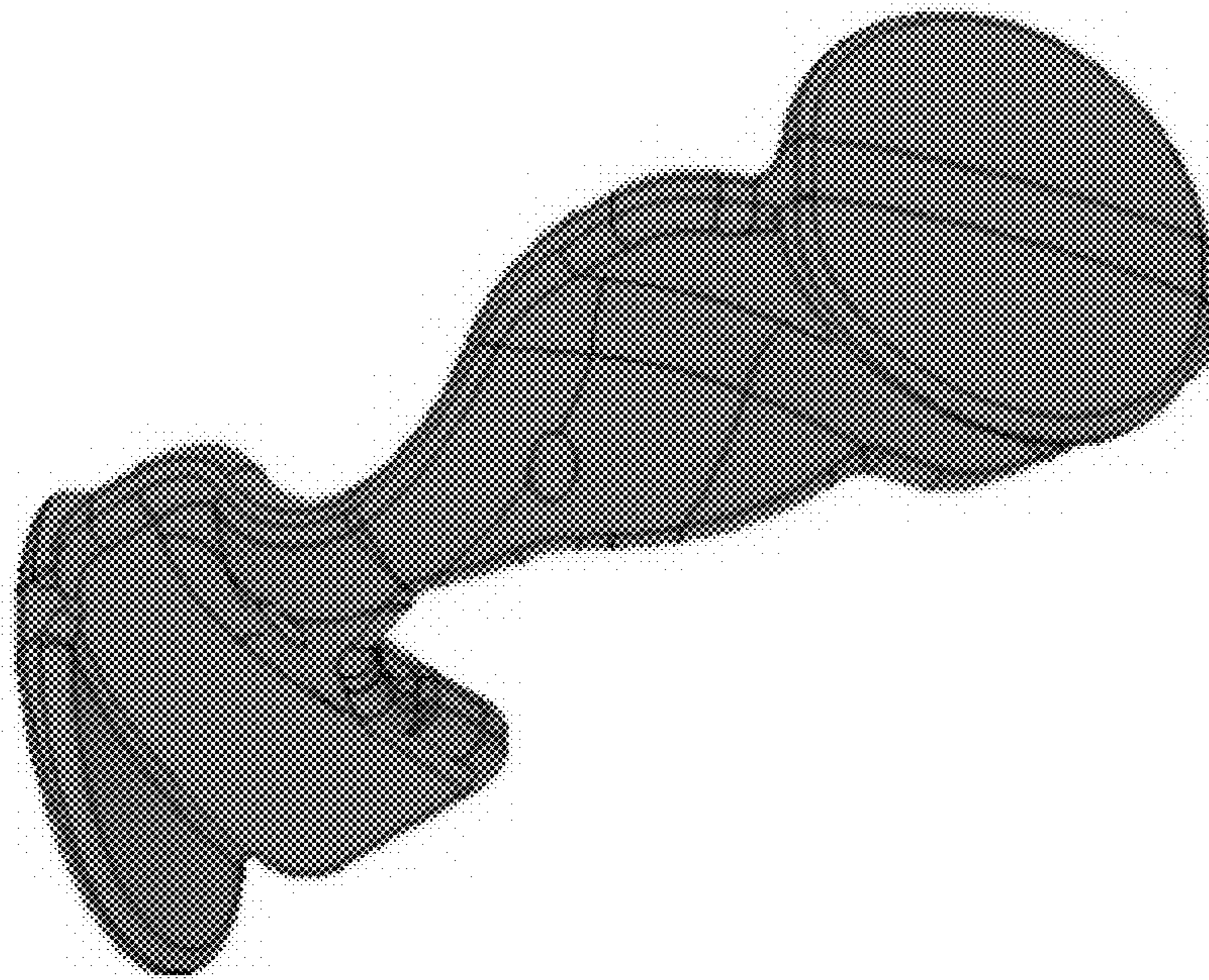

2.3

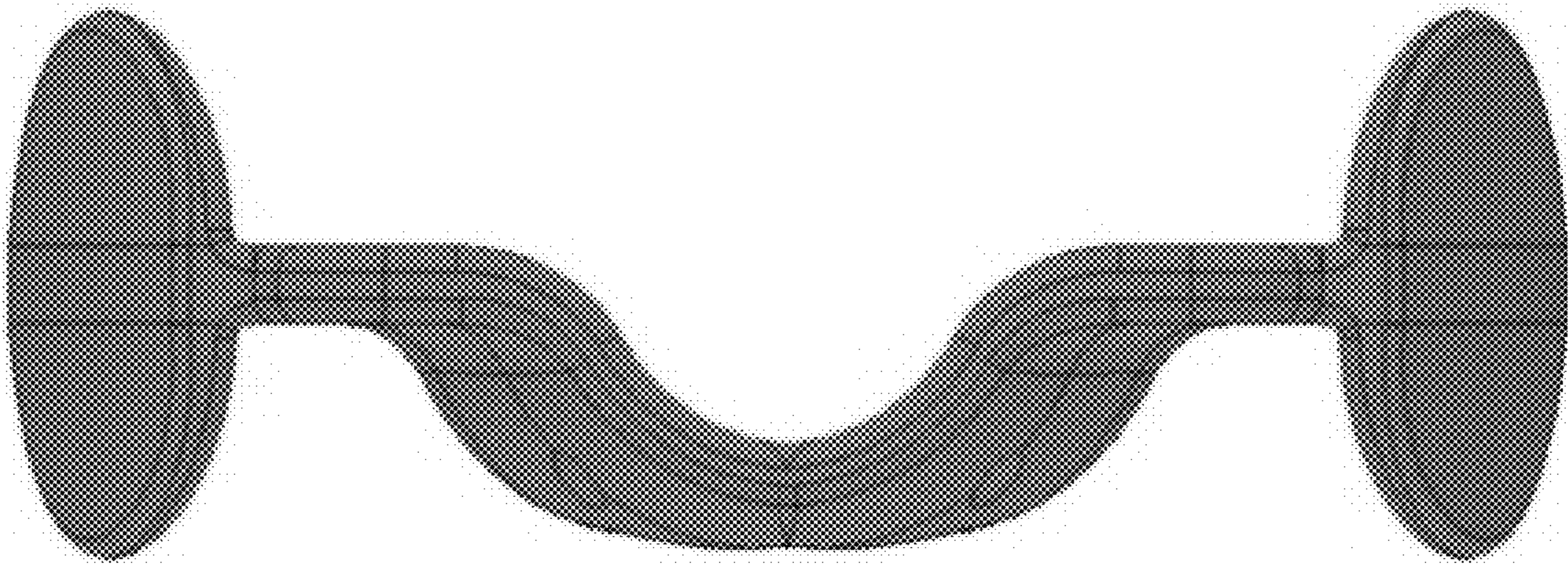

2.4

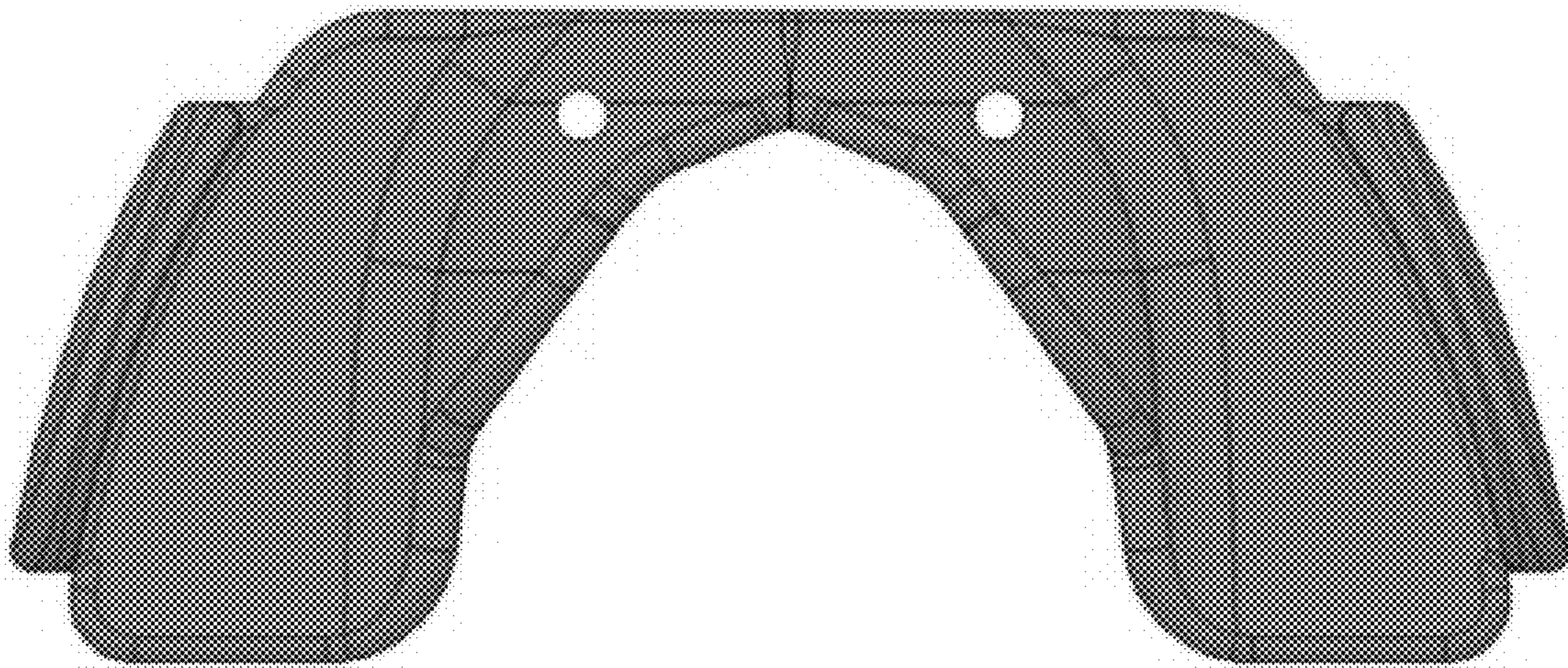

2.5

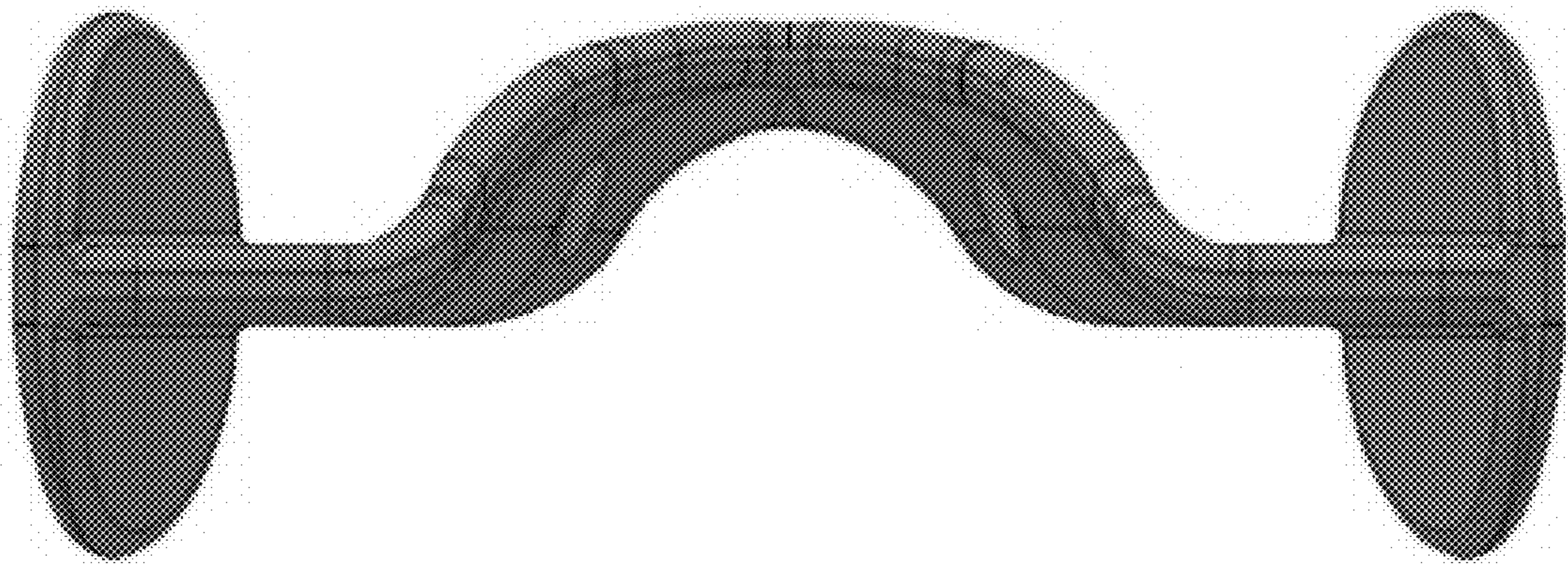

2.6

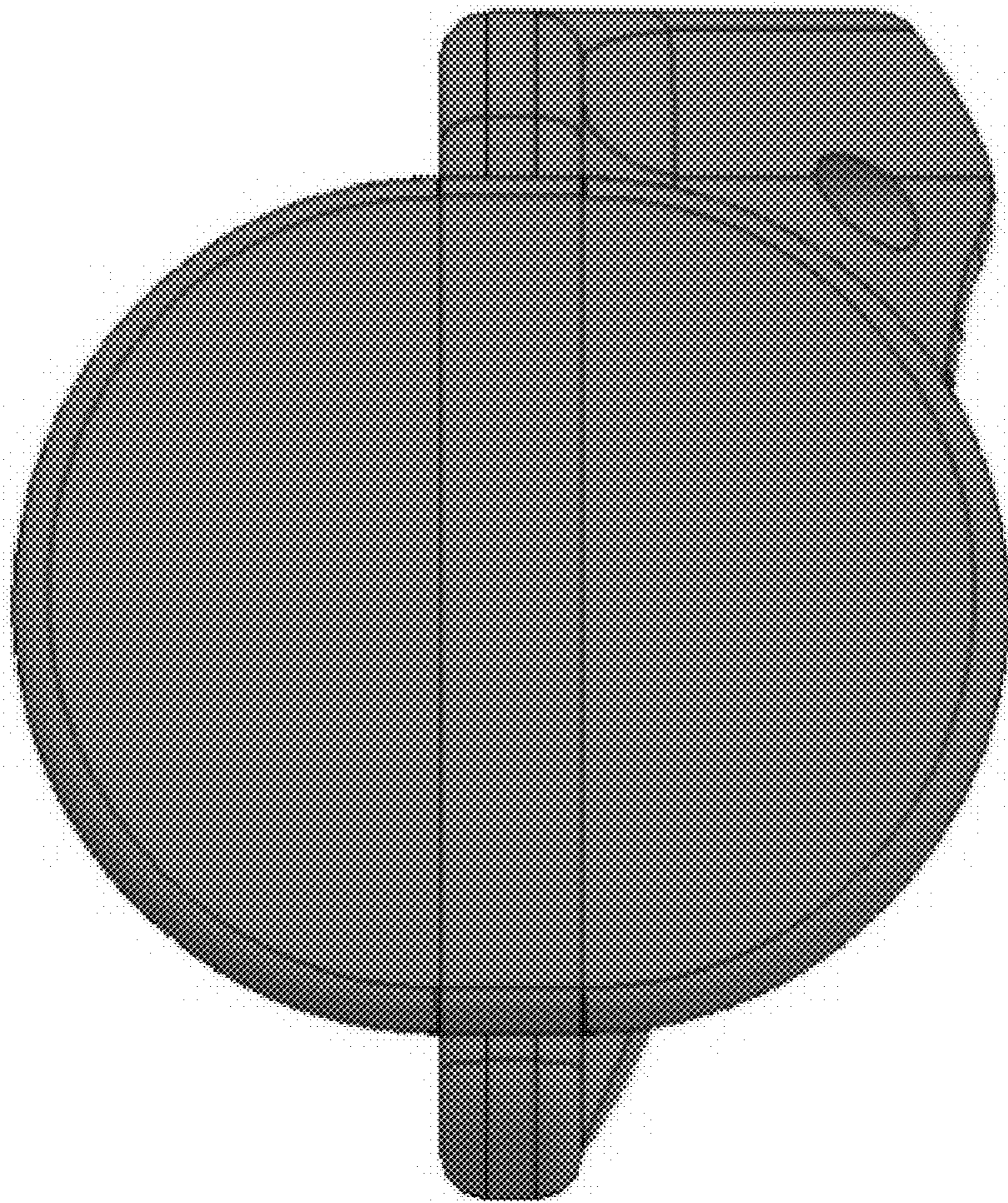

2.7

