

US00D837952S

(12) **United States Design Patent**
Wildfang

(10) **Patent No.:** **US D837,952 S**

(45) **Date of Patent:** **** Jan. 8, 2019**

(54) **FLEXIBLE HOSE WITH TOOL ENGAGEMENT SURFACE AND HOSE CONNECTIONS/HOSE FITTINGS**

(71) Applicant: **Neoperl GmbH**, Mullheim (DE)

(72) Inventor: **Fabian Wildfang**, Mullheim (DE)

(73) Assignee: **Neoperl GmbH**, Müllheim (DE)

(**) Term: **15 Years**

(21) Appl. No.: **29/597,875**

(22) Filed: **Mar. 21, 2017**

Related U.S. Application Data

(62) Division of application No. 29/543,136, filed on Oct. 21, 2015, now Pat. No. Des. 787,027, which is a (Continued)

(30) **Foreign Application Priority Data**

Mar. 27, 2014 (EM) 001407555

(51) **LOC (11) Cl.** **23-01**

(52) **U.S. Cl.**
USPC **D23/266**

(58) **Field of Classification Search**
USPC D23/213, 223, 224, 229, 230, 259, 260, D23/261, 263, 266; D24/129; D13/155 (Continued)

(56) **References Cited**

U.S. PATENT DOCUMENTS

D180,850 S * 8/1957 Stahl D23/266
D318,102 S * 7/1991 Papai 285/239
(Continued)

FOREIGN PATENT DOCUMENTS

DE DM082874 2/2014

OTHER PUBLICATIONS

Flexile hose, no reference date available, [site visited Oct. 9, 2014]. Available online <URL: catalog.rusbiz.com/product/stainless_steel_flexible_metal_hose_pipe_for_gas_connector_69772.html>.

Primary Examiner — Darlington Ly
Assistant Examiner — Daniel J Domino
(74) *Attorney, Agent, or Firm* — Volpe and Koenig, P.C.

(57) **CLAIM**

The ornamental design for a flexible hose with tool engagement surface and hose connection/hose fittings, as shown and described.

DESCRIPTION

FIG. 1 is a top plan view of a flexible hose with tool engagement surface and hose connection/hose fittings in accordance with my design;
FIG. 2 is a top, front perspective view thereof;
FIG. 3 is a bottom view thereof;
FIG. 4 is a left side elevational view thereof;
FIG. 5 is a front elevational view thereof;
FIG. 6 is a right side elevational view thereof; and
FIG. 7 is a rear elevational view thereof;
FIG. 8 is a top plan view of a second embodiment of a flexible hose with tool engagement surface and hose connection/hose fittings in accordance with my design;
FIG. 9 is a top, front perspective view thereof;
FIG. 10 is a bottom view thereof;
FIG. 11 is a left side elevational view thereof;
FIG. 12 is a front elevational view thereof;
FIG. 13 is a right side elevational view thereof; and
FIG. 14 is a rear elevational view thereof;
FIG. 15 is a top plan view of a third embodiment of a flexible hose with tool engagement surface and hose connection/hose fittings in accordance with my design
FIG. 16 is a top, front perspective view thereof;
FIG. 17 is a bottom view thereof;
FIG. 18 is a left side elevational view thereof;
FIG. 19 is a front elevational view thereof;
FIG. 20 is a right side elevational view thereof; and
FIG. 21 is a rear elevational view thereof;
FIG. 22 is a top plan view of a third embodiment of a flexible hose with tool engagement surface and hose connection/hose fittings in accordance with my design;
FIG. 23 is a top, front perspective view thereof;
FIG. 24 is a bottom view thereof;

(Continued)

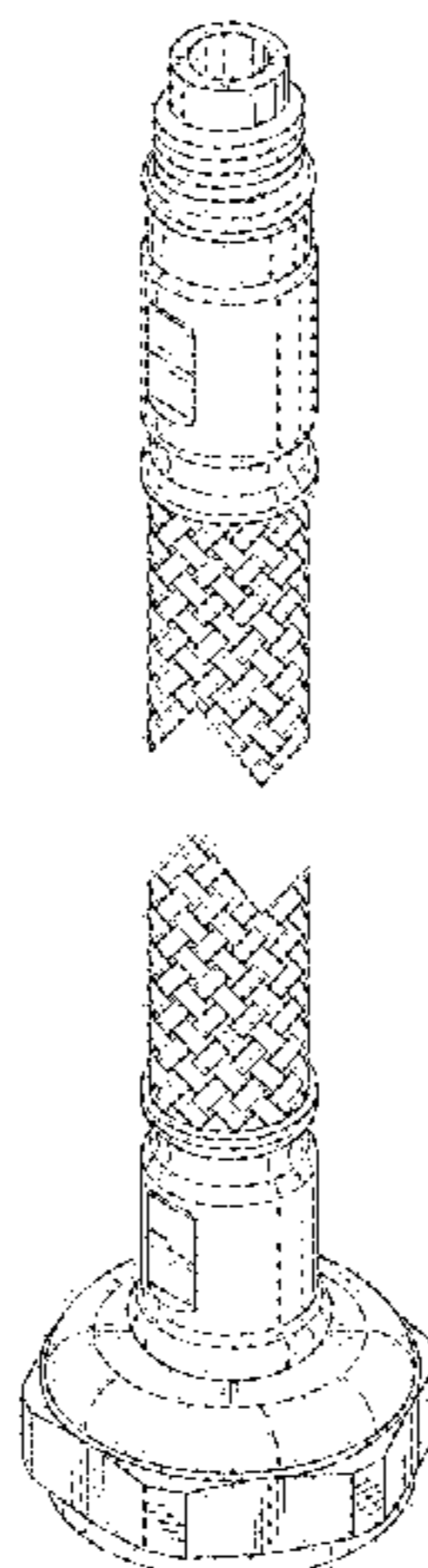

FIG. 25 is a left side elevational view thereof;
 FIG. 26 is a front elevational view thereof;
 FIG. 27 is a right side elevational view thereof; and,
 FIG. 28 is a rear elevational view thereof.
 The broken lines shown represent portions of the flexible
 hose with tool engagement surface and hose connection/
 hose fittings that form no part of the claimed design.

1 Claim, 28 Drawing Sheets

Related U.S. Application Data

division of application No. 29/499,919, filed on Aug.
 20, 2014, now Pat. No. Des. 744,072.

(58) **Field of Classification Search**

CPC F16L 11/10; F16L 11/125; F16L 57/04
 See application file for complete search history.

(56) **References Cited**

U.S. PATENT DOCUMENTS

D368,299 S * 3/1996 Ratledge D23/235
 D396,730 S * 8/1998 Schaupp D23/259

D412,738 S * 8/1999 Kuwabara D23/233
 6,302,152 B1 * 10/2001 Mulligan F16L 11/10
 138/109
 D479,741 S * 9/2003 Chiu D23/266
 D483,096 S * 12/2003 Gotoh D23/235
 D499,464 S * 12/2004 Caine D23/233
 D597,637 S * 8/2009 Krohmer D23/266
 D603,941 S * 11/2009 Leelaprachakul D23/266
 D605,737 S * 12/2009 von Glanstaetten D23/266
 D608,424 S * 1/2010 Katsuta D23/266
 D615,166 S * 5/2010 Patti D23/266
 D627,038 S * 11/2010 Yu D23/260
 D627,039 S * 11/2010 Yu D23/260
 D642,244 S * 7/2011 Wilhelm D23/262
 D648,008 S * 11/2011 Percoco D23/262
 D698,415 S * 1/2014 Wyne D23/213
 D700,683 S * 3/2014 Atwell D23/235
 D744,072 S * 11/2015 Wildfang D23/266
 D759,216 S * 6/2016 Kozak D23/266
 D759,876 S 6/2016 Kozak
 D760,876 S * 7/2016 Kozak D23/266
 2008/0190506 A1 * 8/2008 Cleveland F16L 57/04
 138/110

* cited by examiner

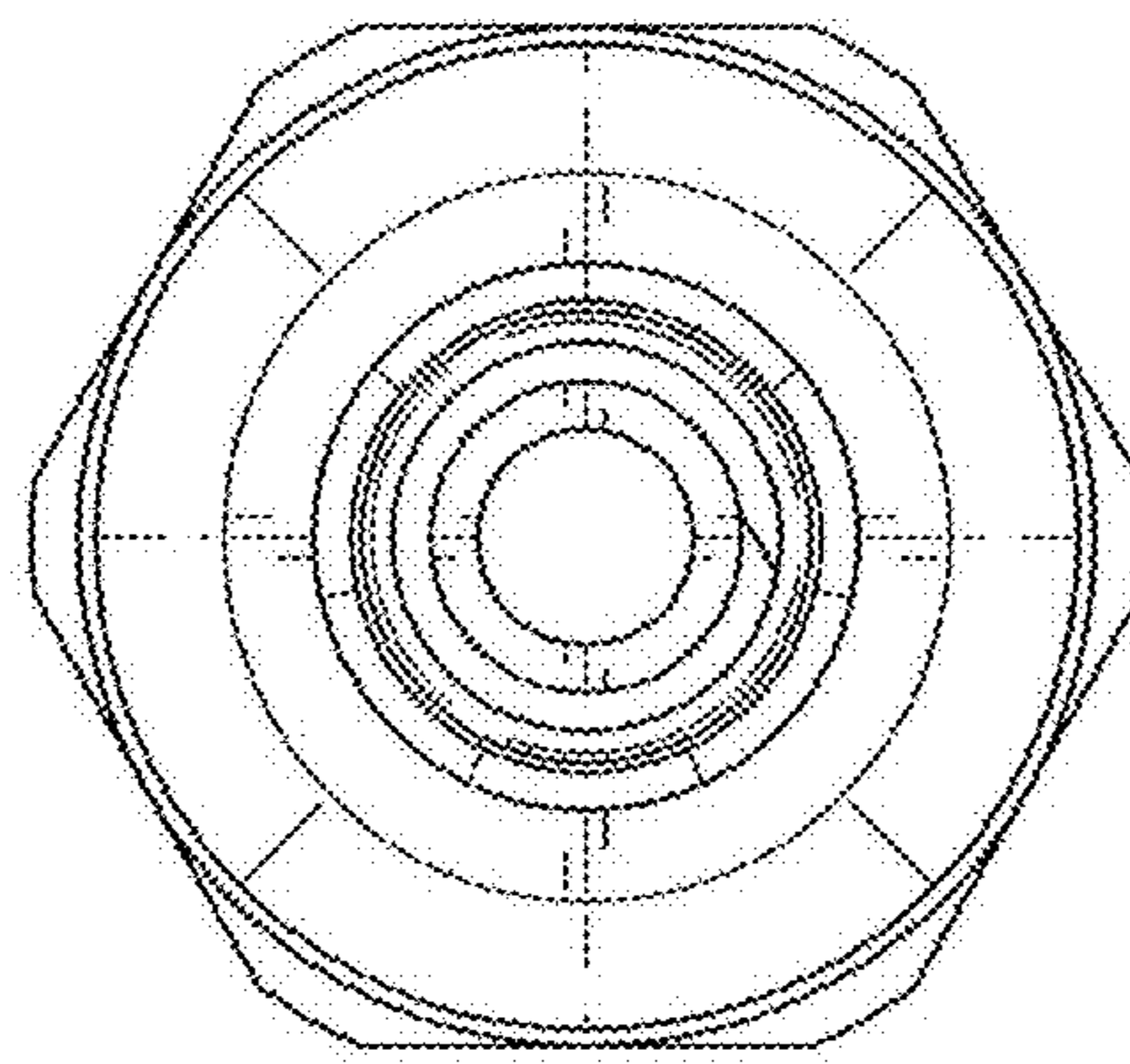

FIG. 1

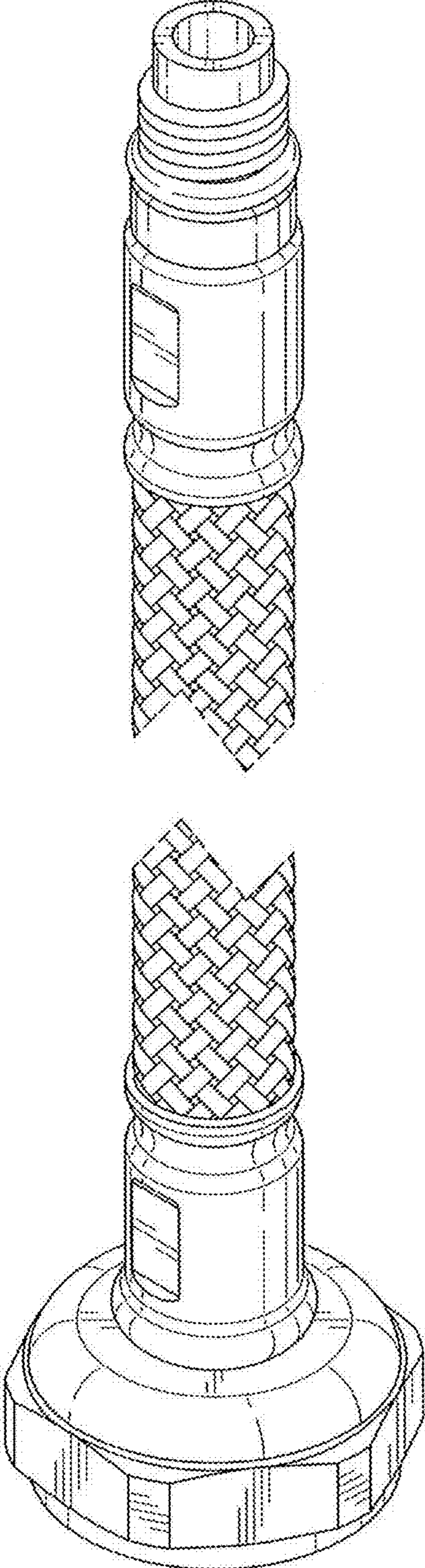

FIG. 2

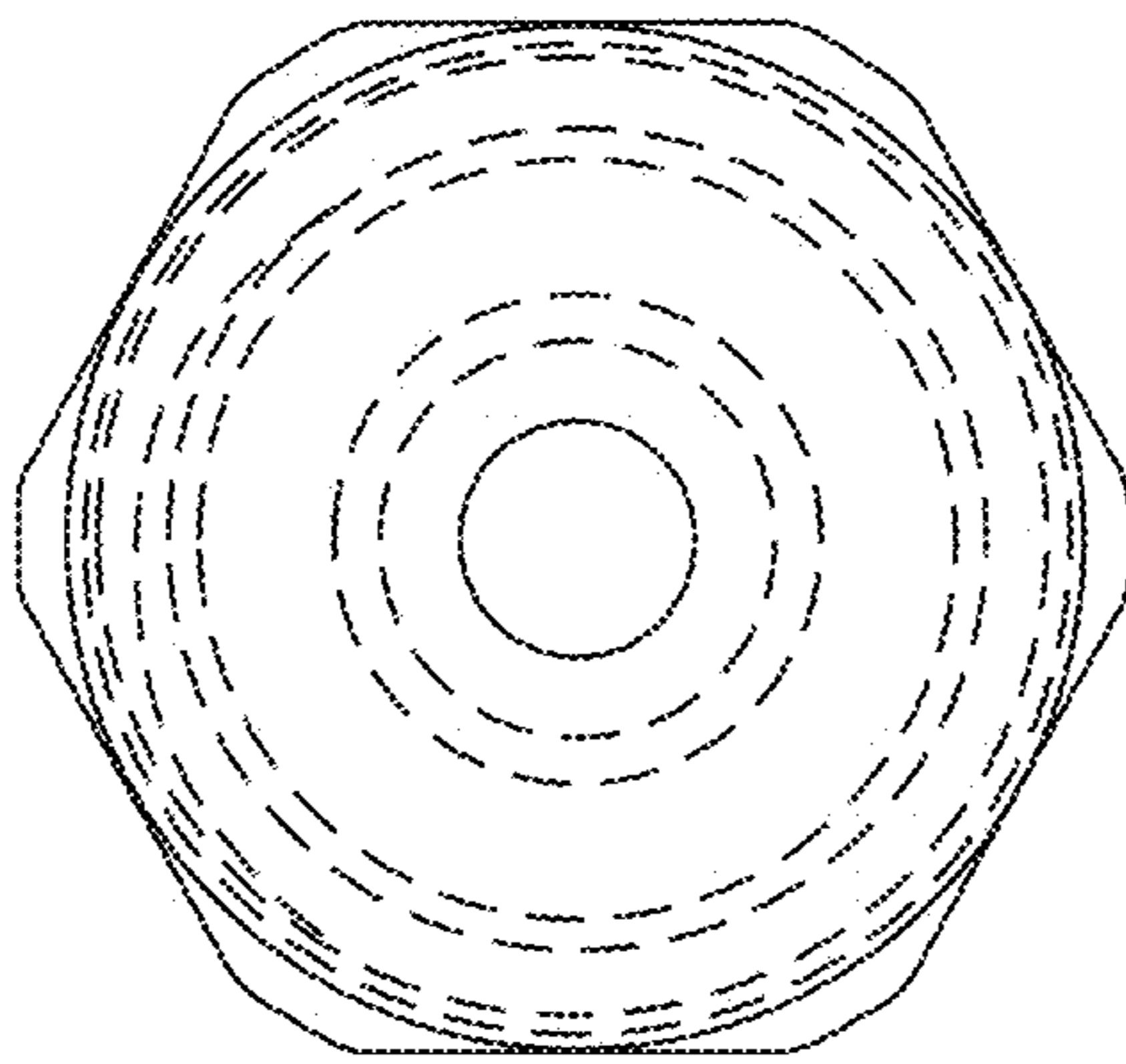

Fig. 3

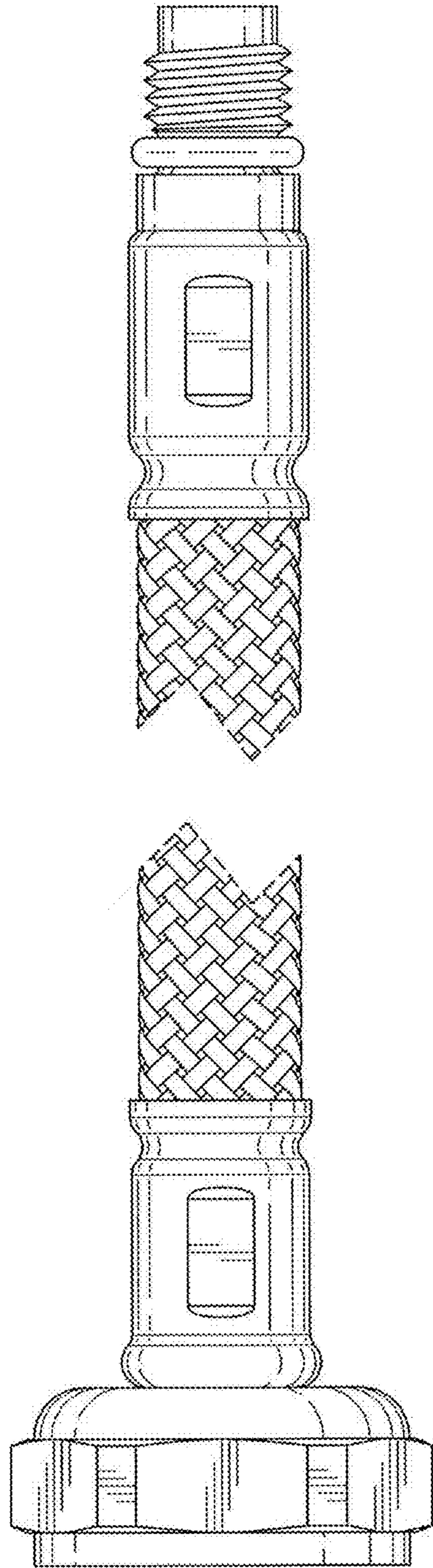

Fig. 4

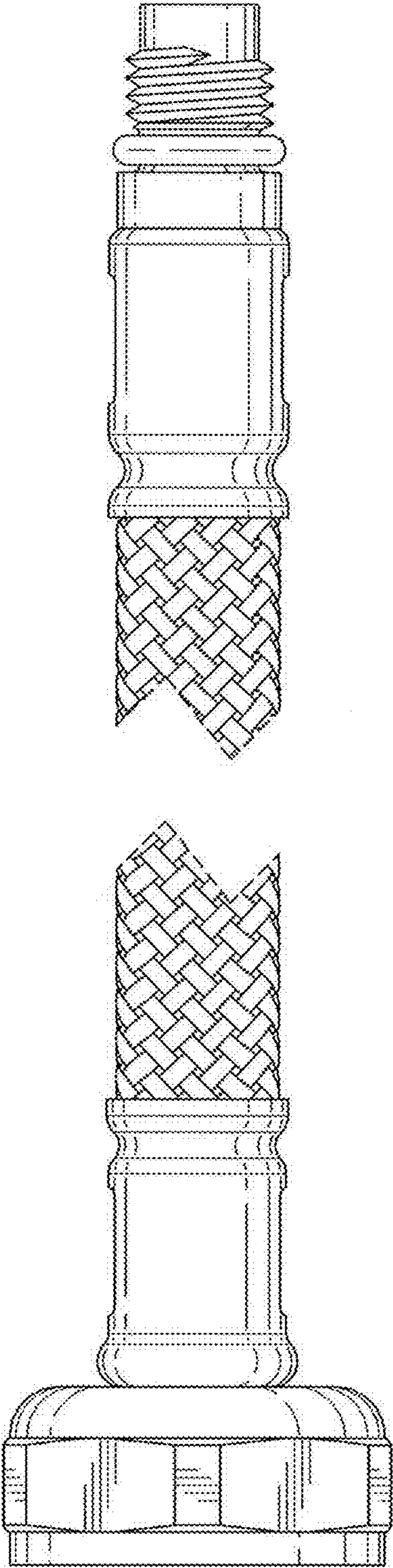

Fig. 5

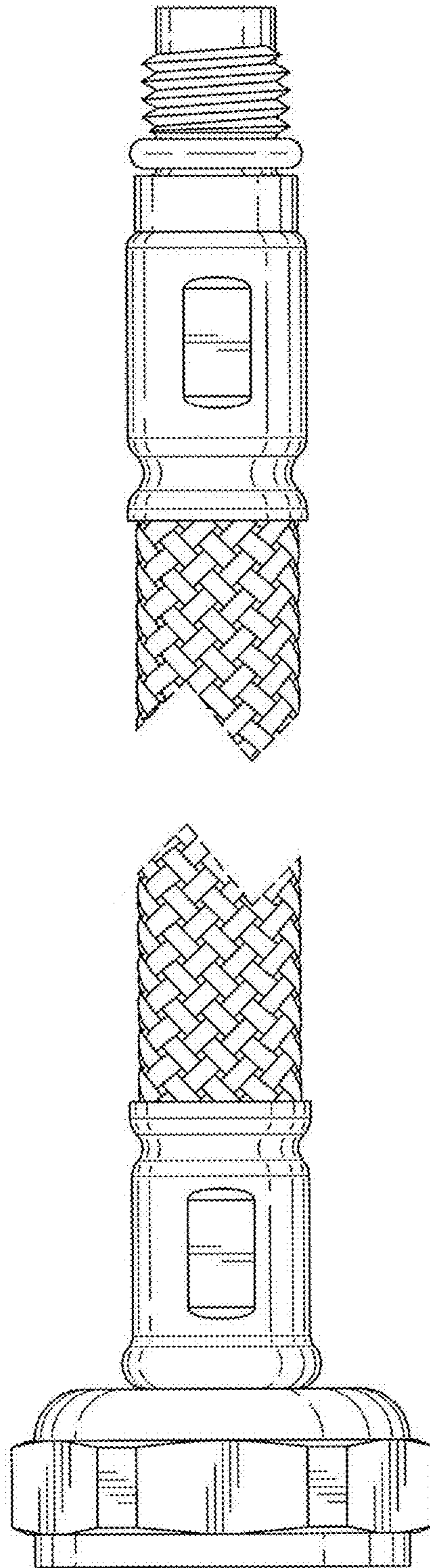

Fig. 6

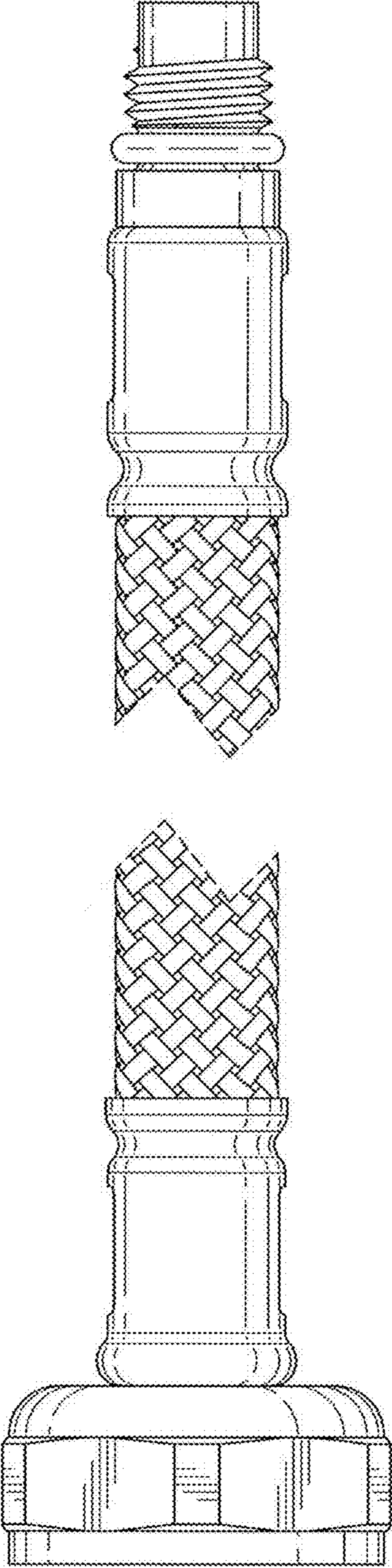

Fig. 7

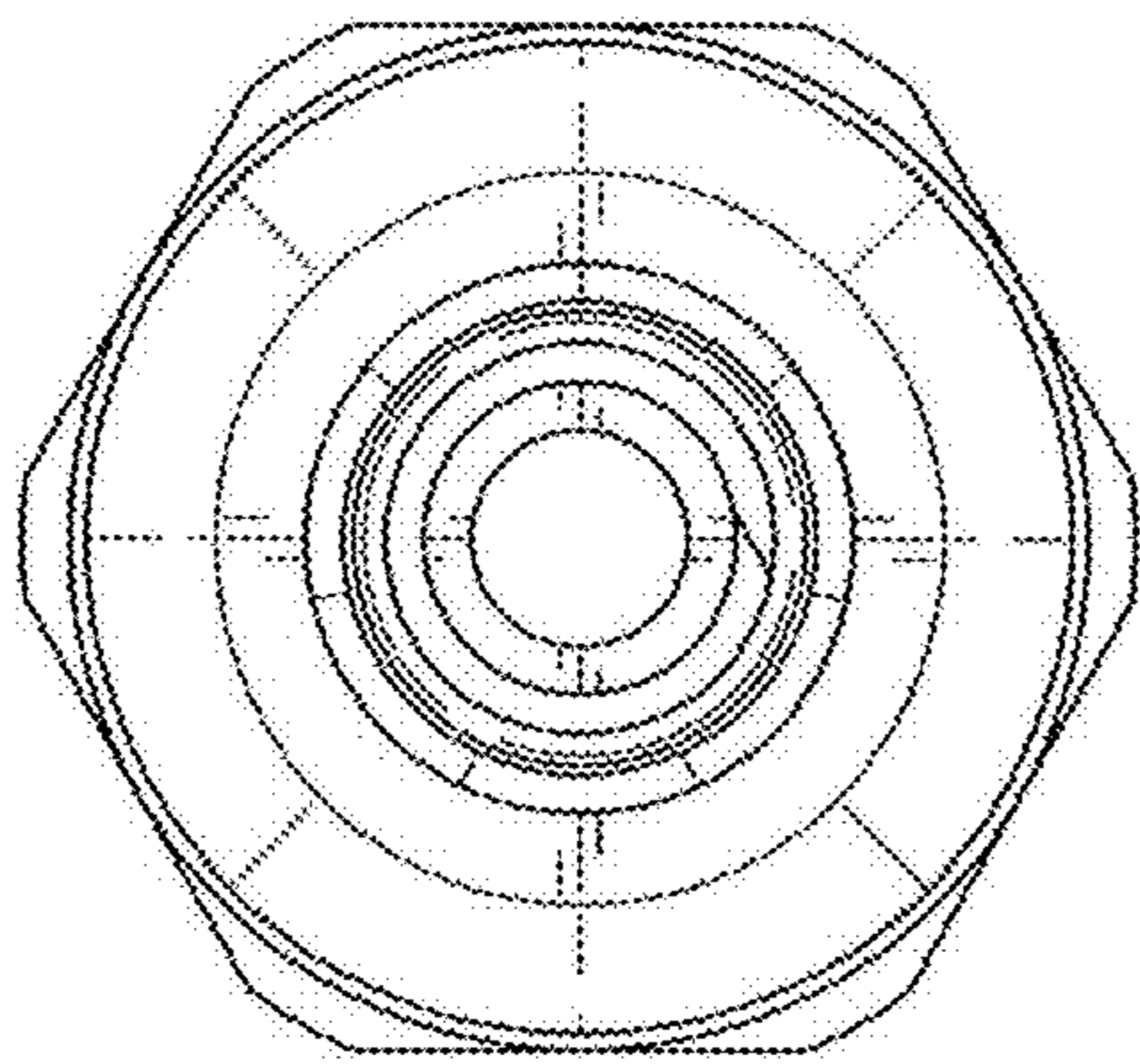

Fig. 8

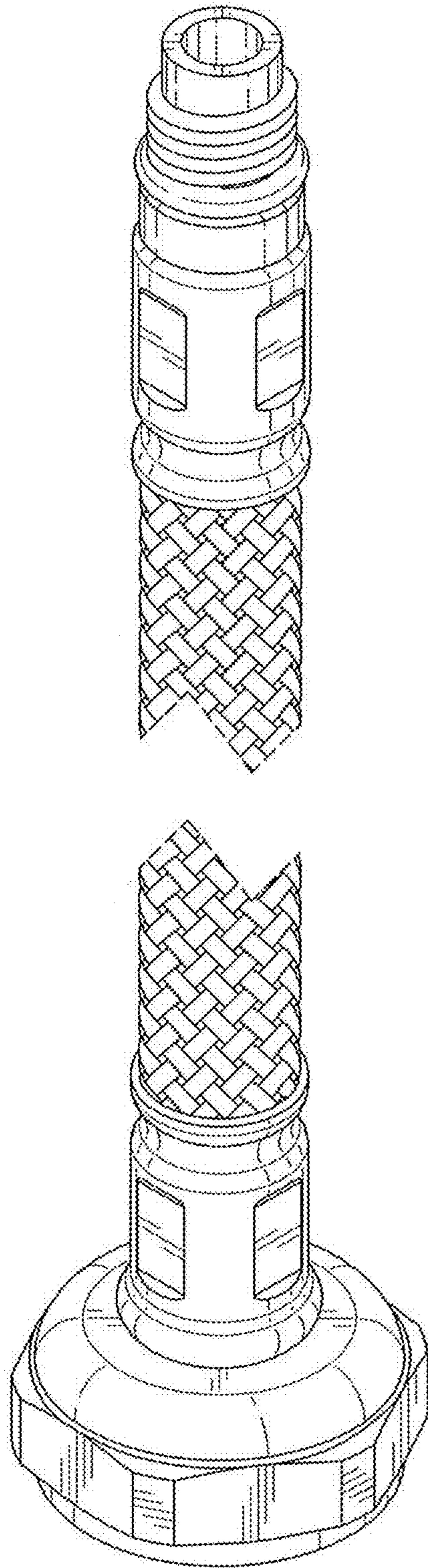

Fig. 9

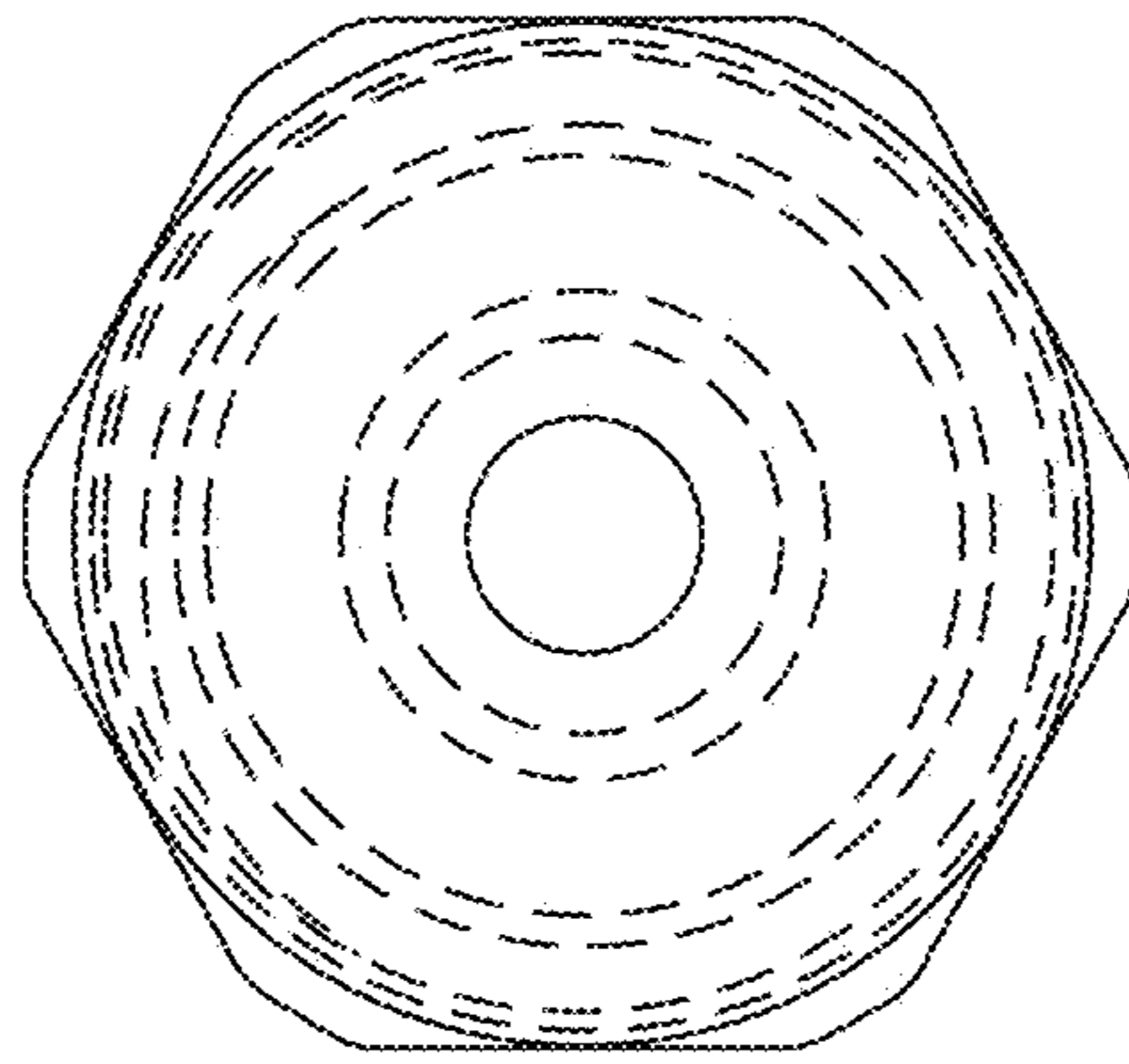

Fig. 10

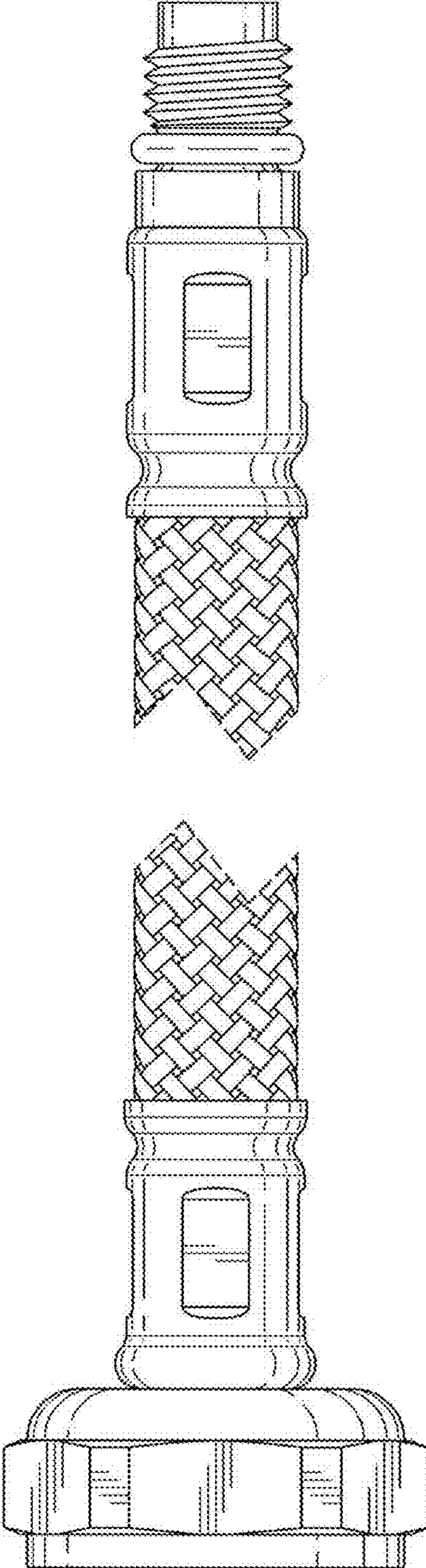

Fig. 11

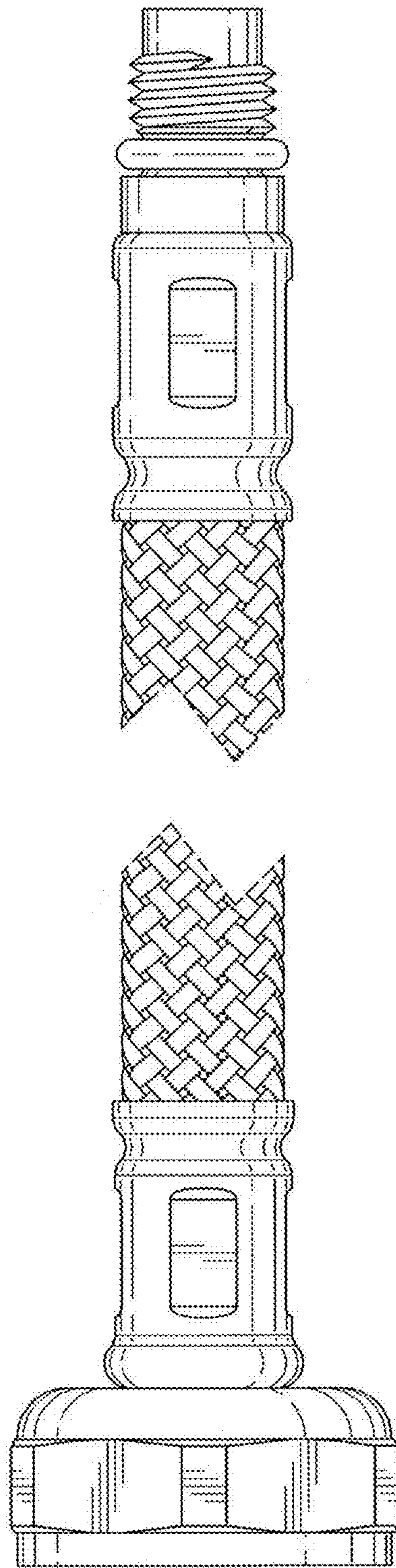

Fig. 12

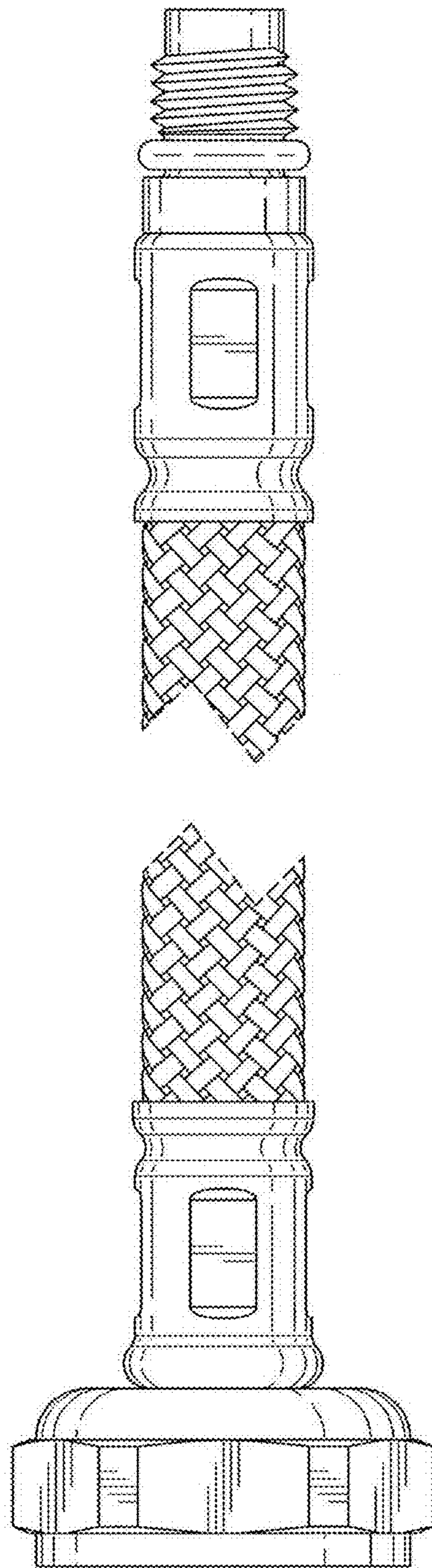

Fig. 13

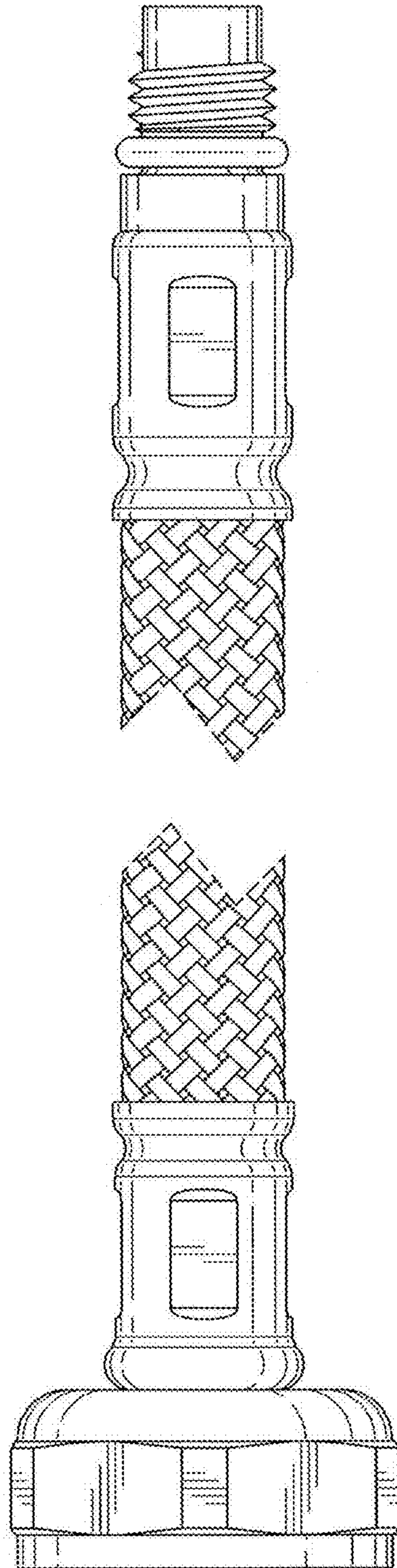

Fig. 14

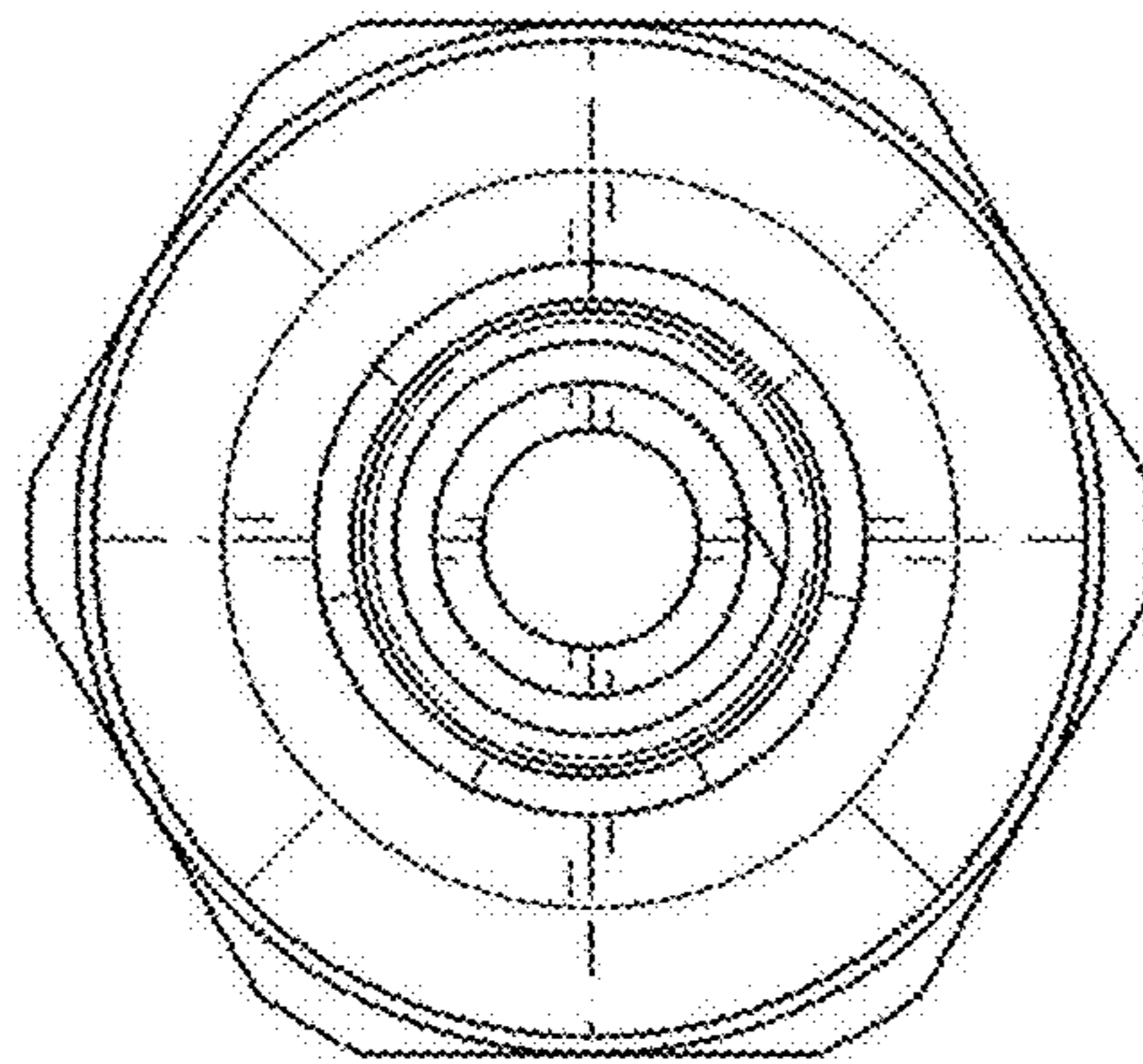

Fig. 15

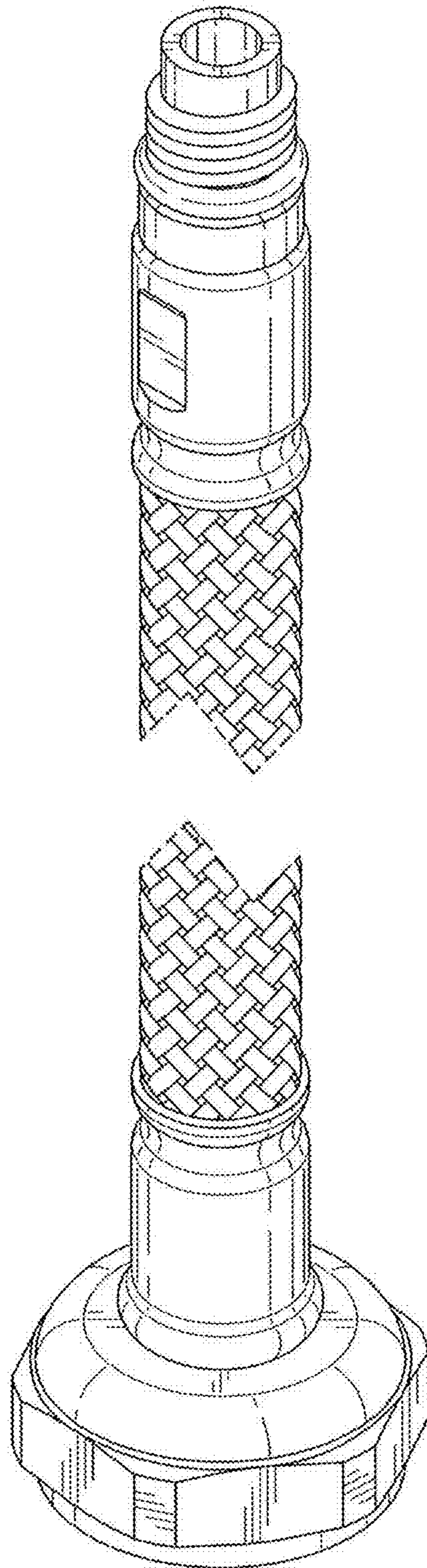

Fig. 16

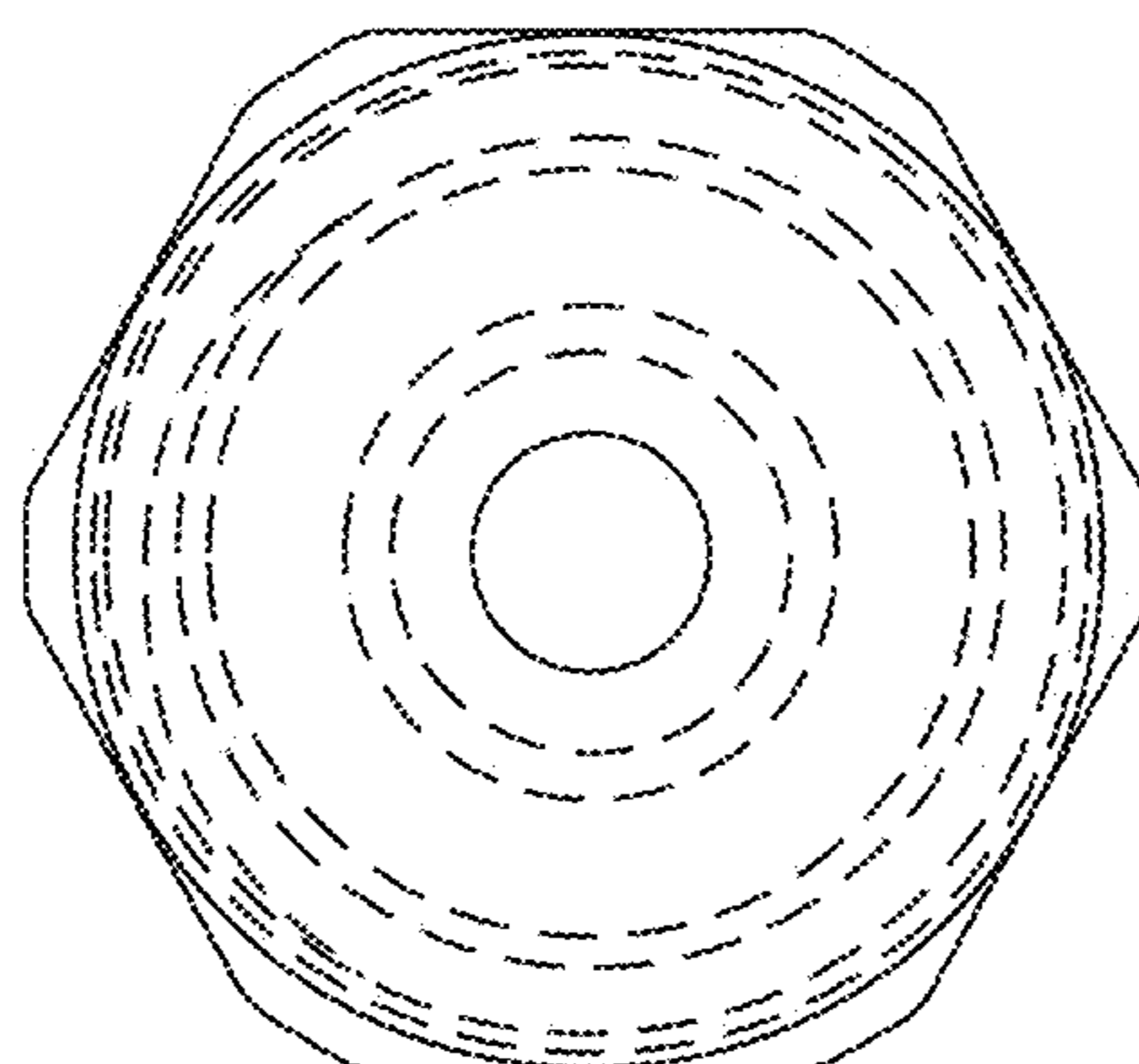

Fig. 17

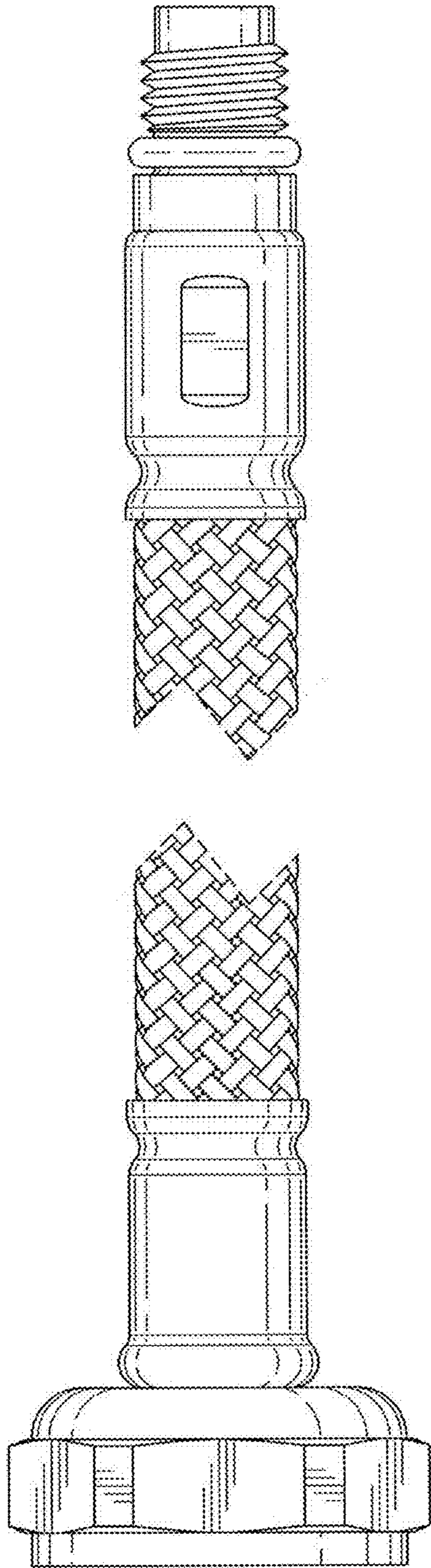

Fig. 18

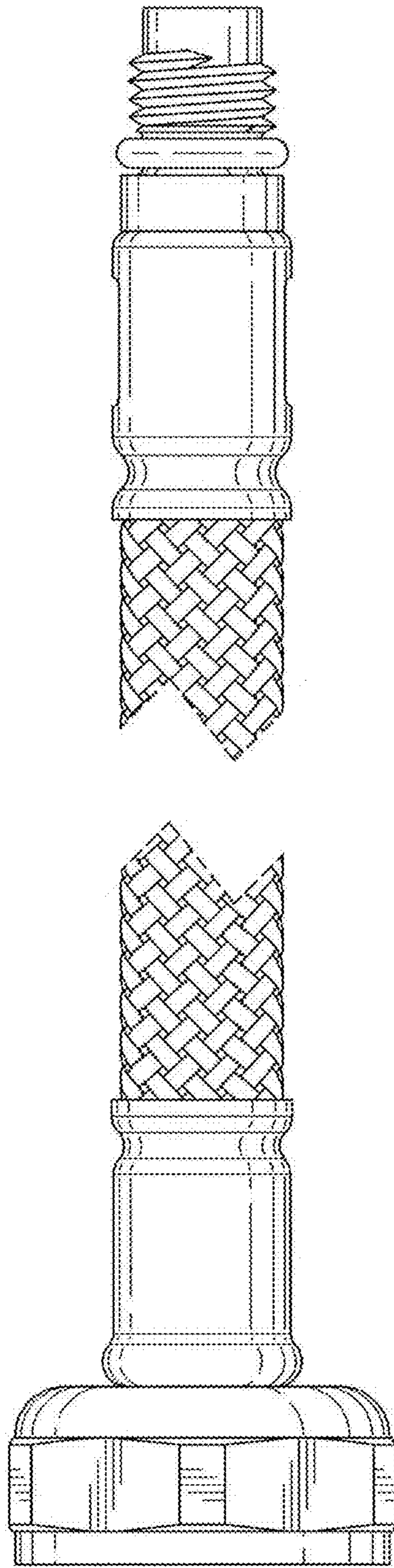

Fig. 19

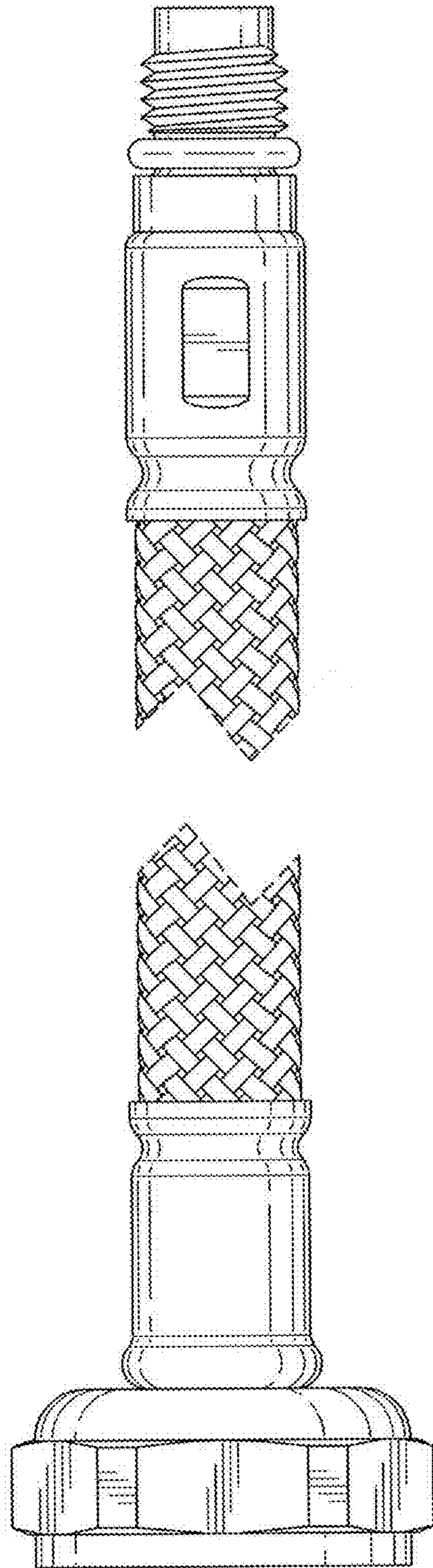

Fig. 20

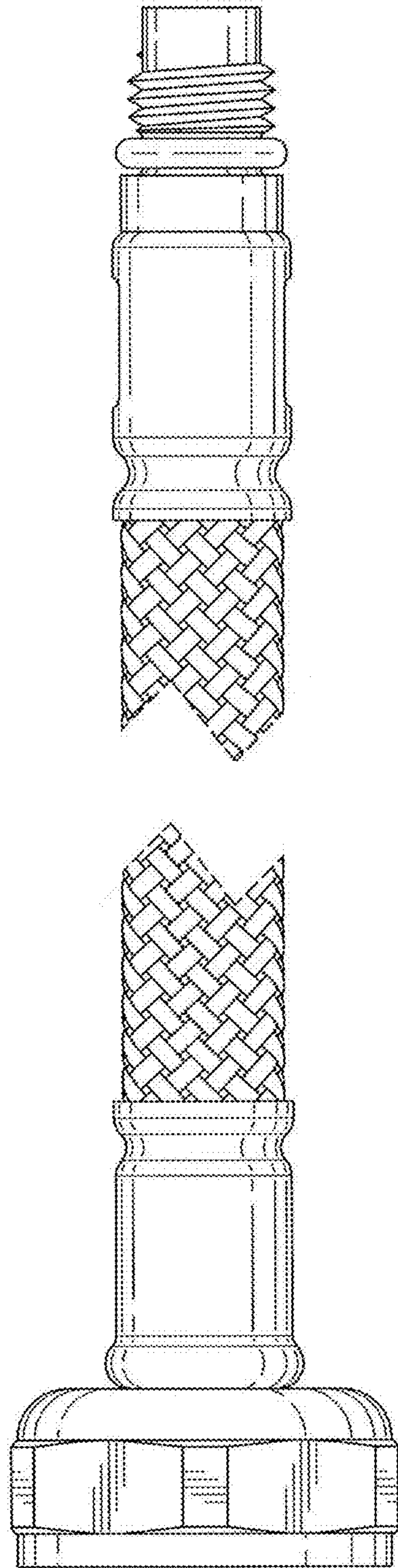

Fig. 21

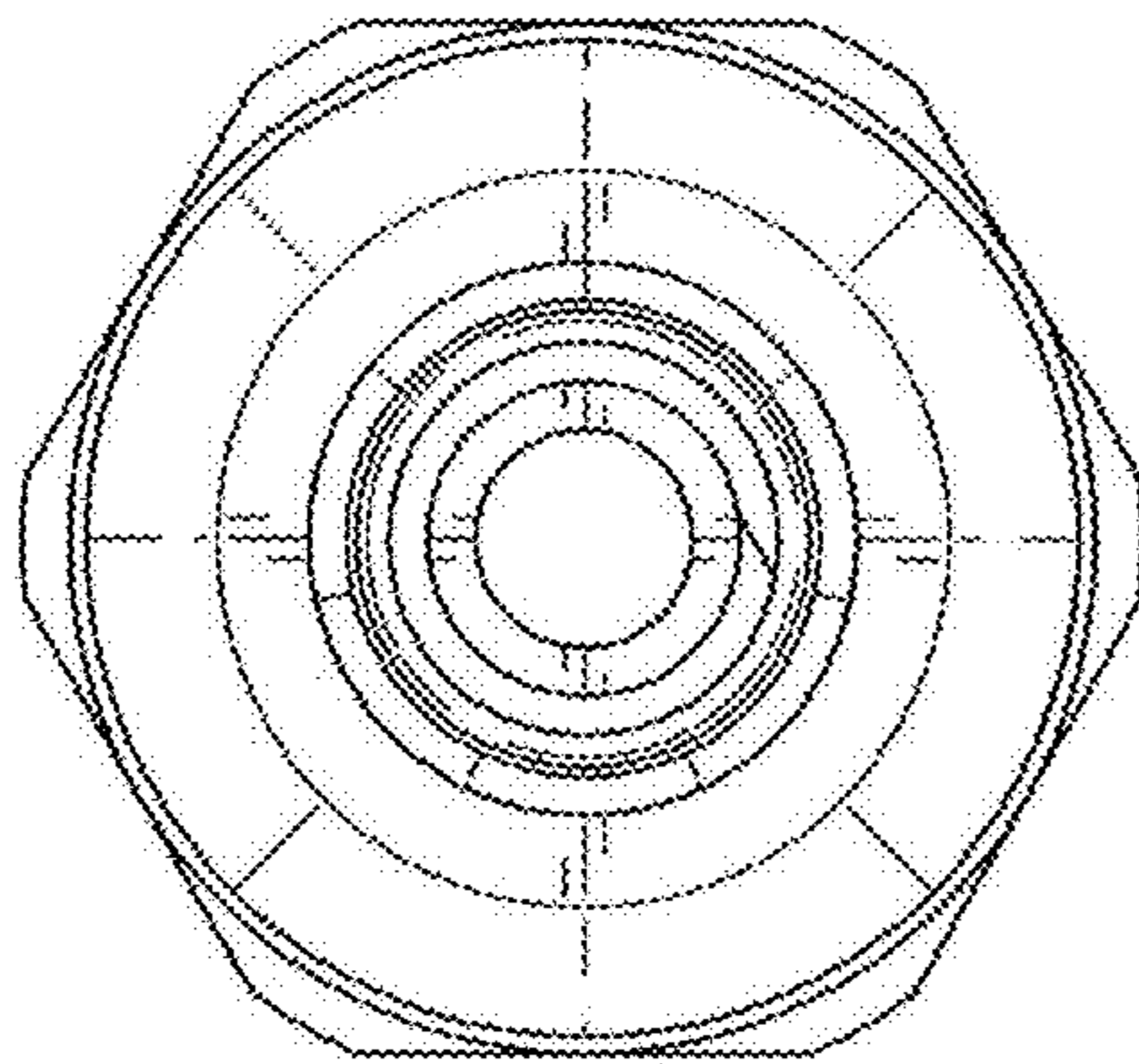

Fig. 22

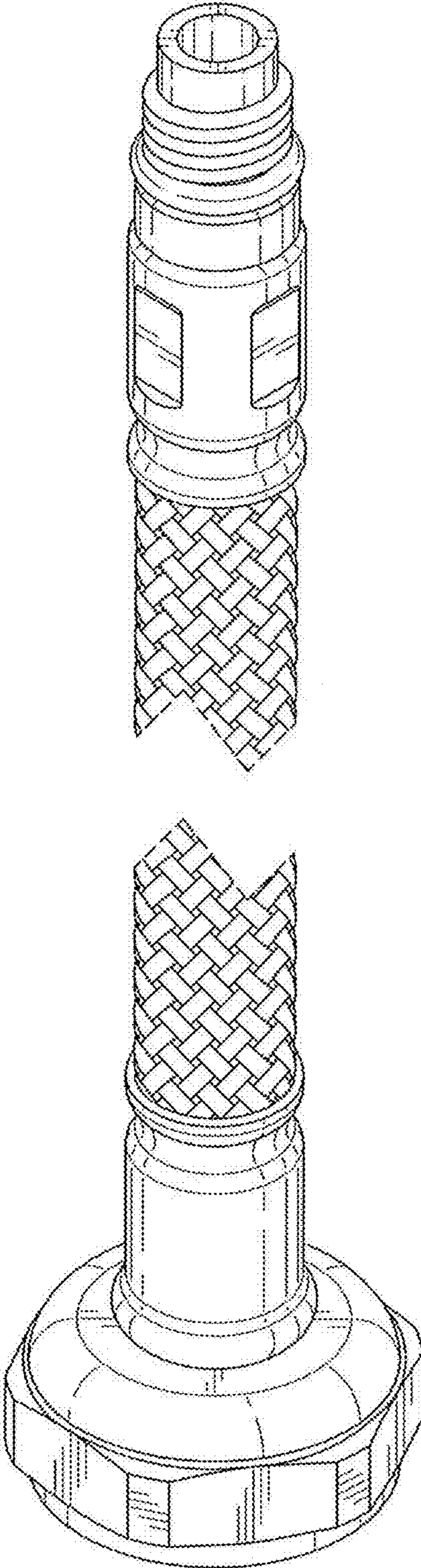

Fig. 23

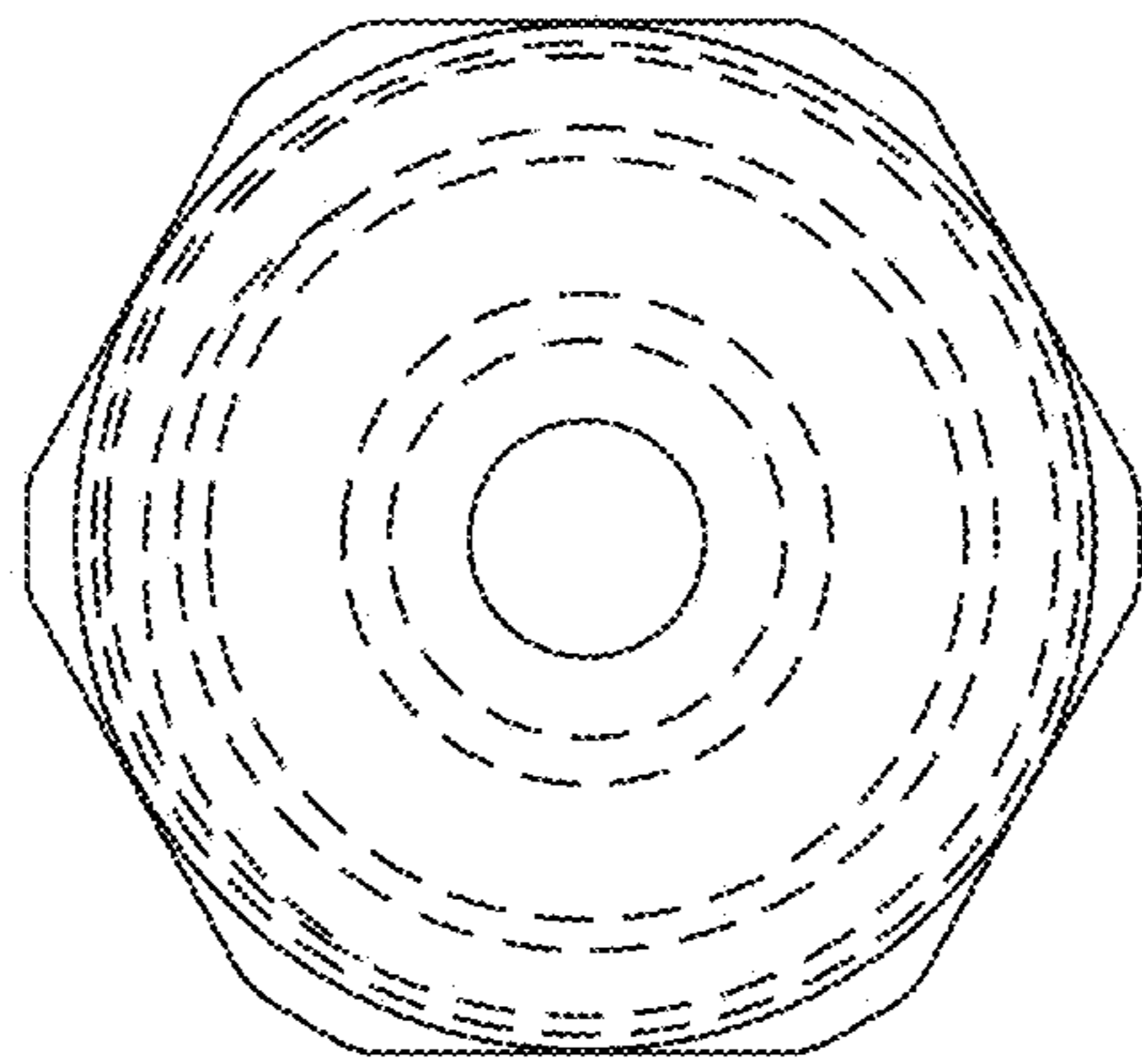

Fig. 24

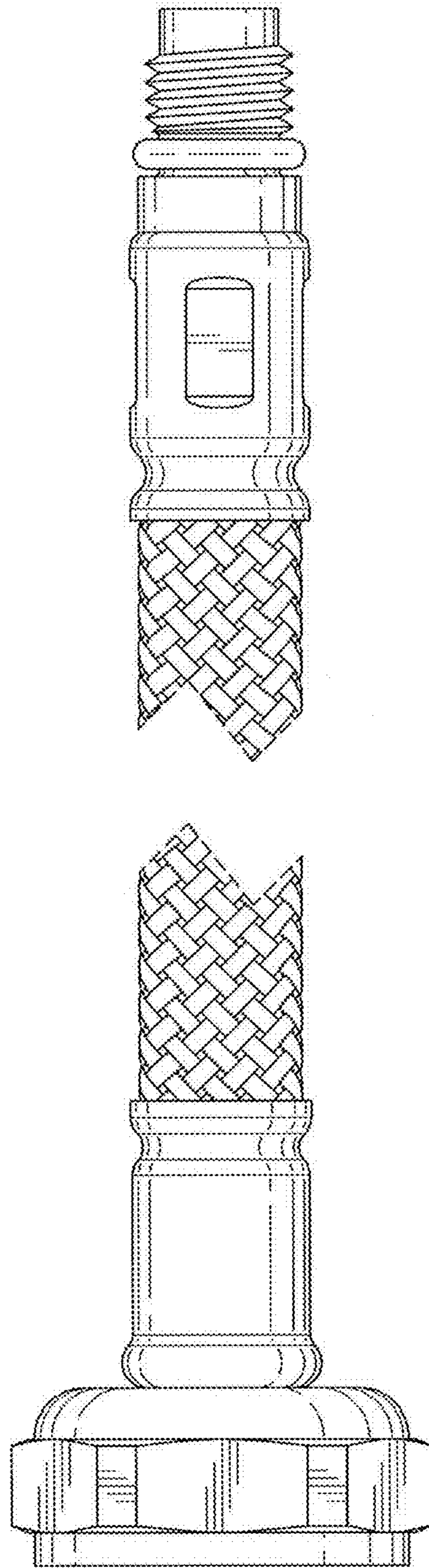

Fig. 25

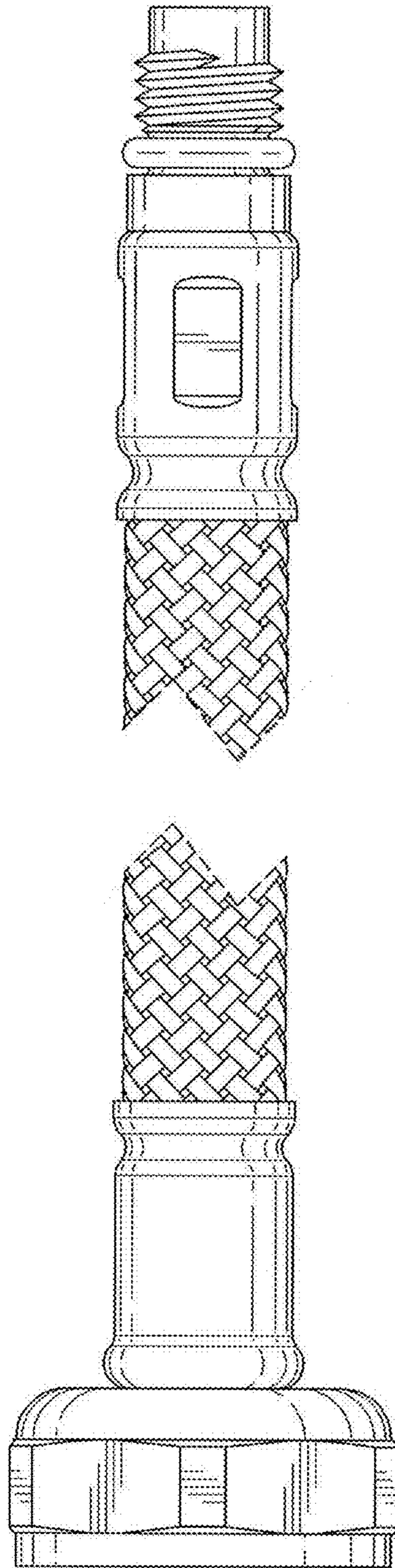

Fig. 26

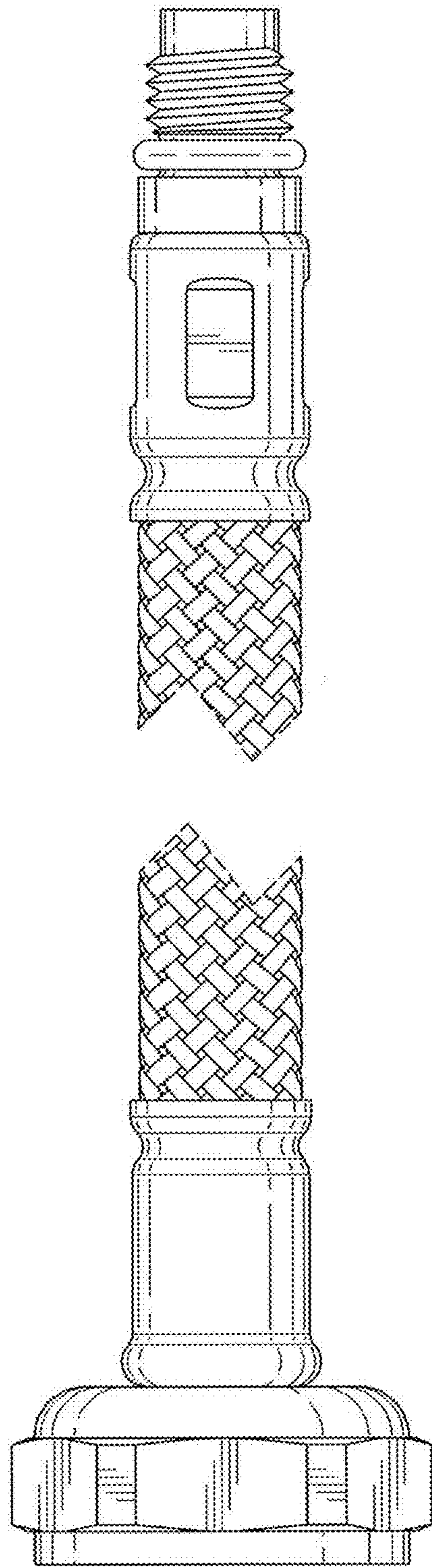

Fig. 27

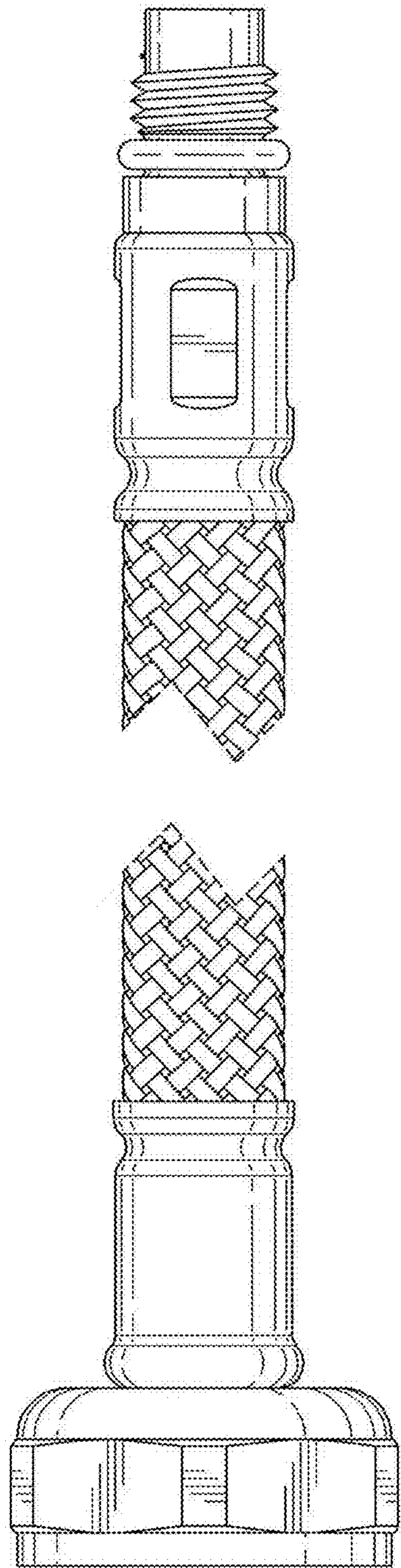

Fig. 28