



US00D837911S

(12) **United States Design Patent** (10) **Patent No.:** **US D837,911 S**
Bruschi et al. (45) **Date of Patent:** **** Jan. 8, 2019**

(54) **PUTTER GOLF CLUB HEAD**

OTHER PUBLICATIONS

(71) Applicant: **Taylor Made Golf Company, Inc.**,
Carlsbad, CA (US)

1st Run 1/500 American Edition Gauge Design by David Whitlam
Type M3 AL Putter, available at: <http://www.ebay.ie/itm/201469289827>, 1 page, retrieved Jul. 19, 2017.

(72) Inventors: **Giancarlo Bruschi**, San Diego, CA
(US); **Bill Price**, Santa Ana, CA (US);
Keith Stuart Sbarbaro, San Diego, CA
(US); **Shawn Mullin**, Ottawa (CA)

(Continued)

Primary Examiner — Mitchell I. Siegel
(74) *Attorney, Agent, or Firm* — Klarquist Sparkman LLP

(73) Assignee: **Taylor Made Golf Company, Inc.**,
Carlsbad, CA (US)

(57) **CLAIM**
We claim the ornamental design for a putter golf club head,
as shown and described.

(**) Term: **15 Years**

DESCRIPTION

(21) Appl. No.: **29/600,787**

(22) Filed: **Apr. 14, 2017**

(51) **LOC (11) Cl.** **21-02**

(52) **U.S. Cl.**
USPC **D21/736**

(58) **Field of Classification Search**
USPC D21/736–746, 759
CPC A63B 53/00; A63B 53/04; A63B 53/007;
A63B 53/065; A63B 53/0487; A63B
60/00; A63B 60/46

See application file for complete search history.

FIG. 1 is a top rear perspective view of a putter golf club head according to one embodiment;
FIG. 2 is a bottom rear perspective view of FIG. 1;
FIG. 3 is a front elevation view of FIG. 1;
FIG. 4 is a rear elevation view of FIG. 1;
FIG. 5 is a toe side elevation view of FIG. 1;
FIG. 6 is a heel side elevation view of FIG. 1;
FIG. 7 is a top plan view of FIG. 1;
FIG. 8 is a bottom plan view of FIG. 1;
FIG. 9 is a top rear perspective view of a putter golf club head according to a second embodiment;
FIG. 10 is a bottom rear perspective view of FIG. 8;
FIG. 11 is a front elevation view of FIG. 8;
FIG. 12 is a rear elevation view of FIG. 8;
FIG. 13 is a toe side elevation view of FIG. 8;
FIG. 14 is a heel side elevation view of FIG. 8;
FIG. 15 is a top plan view of FIG. 8; and,
FIG. 16 is a bottom plan view of FIG. 8.

(56) **References Cited**

U.S. PATENT DOCUMENTS

D520,584 S * 5/2006 Karlsen D21/743
D565,137 S * 3/2008 Oldknow D21/736
D569,460 S * 5/2008 Walker D21/743
D587,325 S * 2/2009 Solheim D21/736
D595,370 S * 6/2009 Ines D21/736
D600,295 S * 9/2009 Meeks D21/744
D606,139 S * 12/2009 Ines D21/736
D607,952 S * 1/2010 Demkowski D21/743
D636,829 S * 4/2011 Cardani D21/759

(Continued)

The dashed lines in the drawings are for purposes of illustrating environmental structure as well as portions of the design that form no part of the present claimed design. The drawing is lined for the color red in FIGS. 1-8. FIGS. 9-16 correspond to FIGS. 1-8, but without color lining, to provide surface shading not available in FIGS. 1-8.

1 Claim, 12 Drawing Sheets

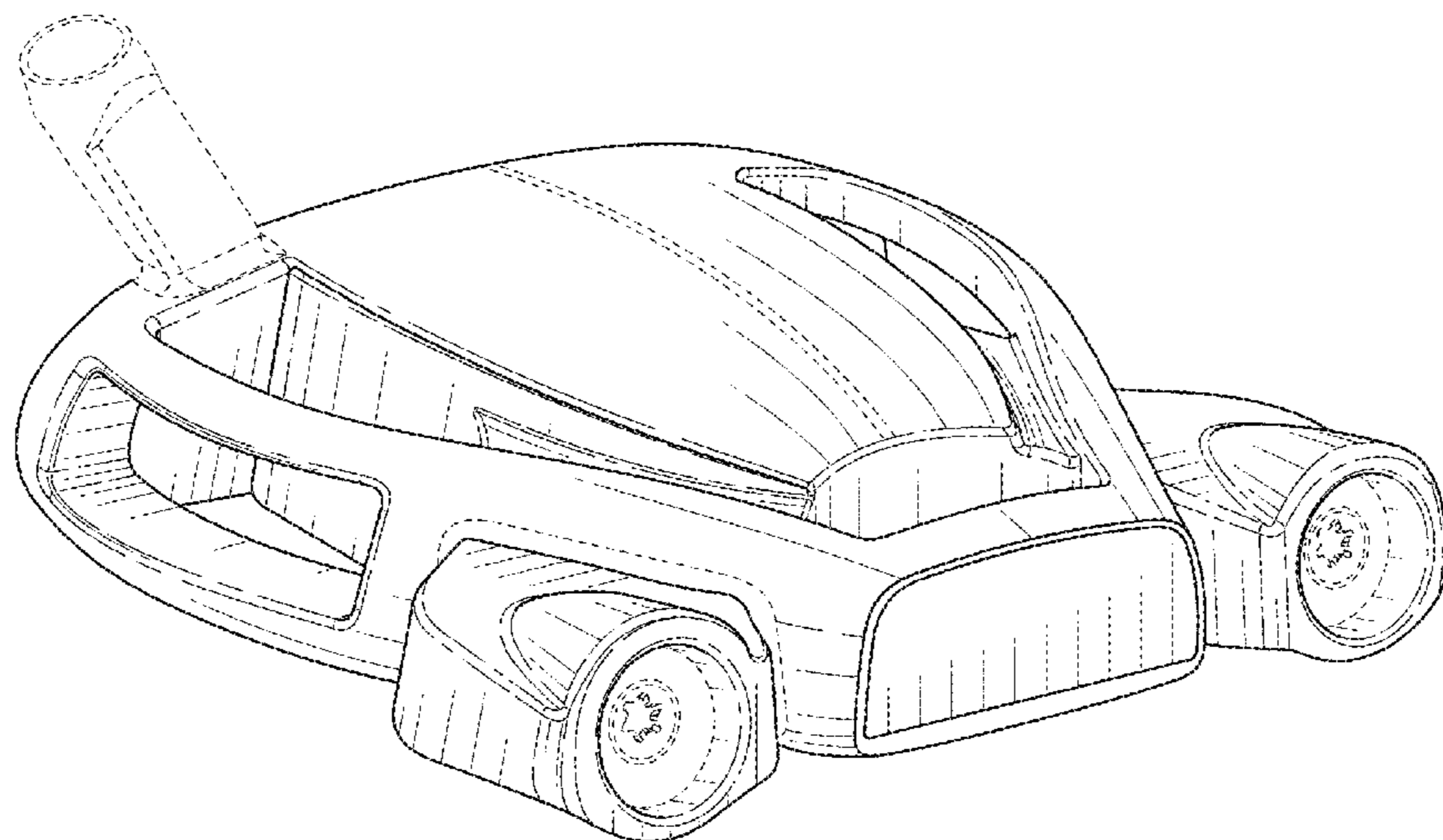

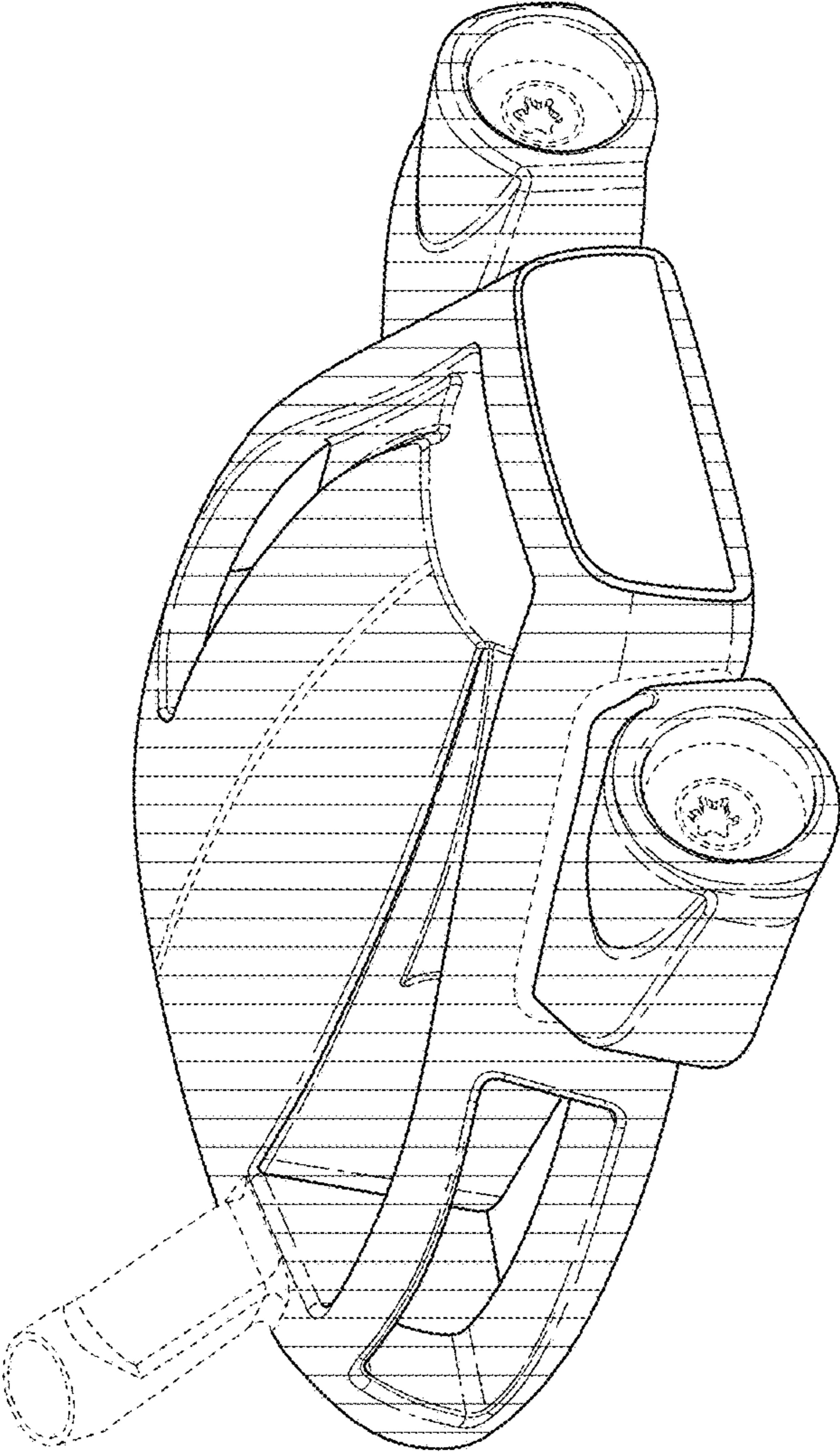

FIG. 1

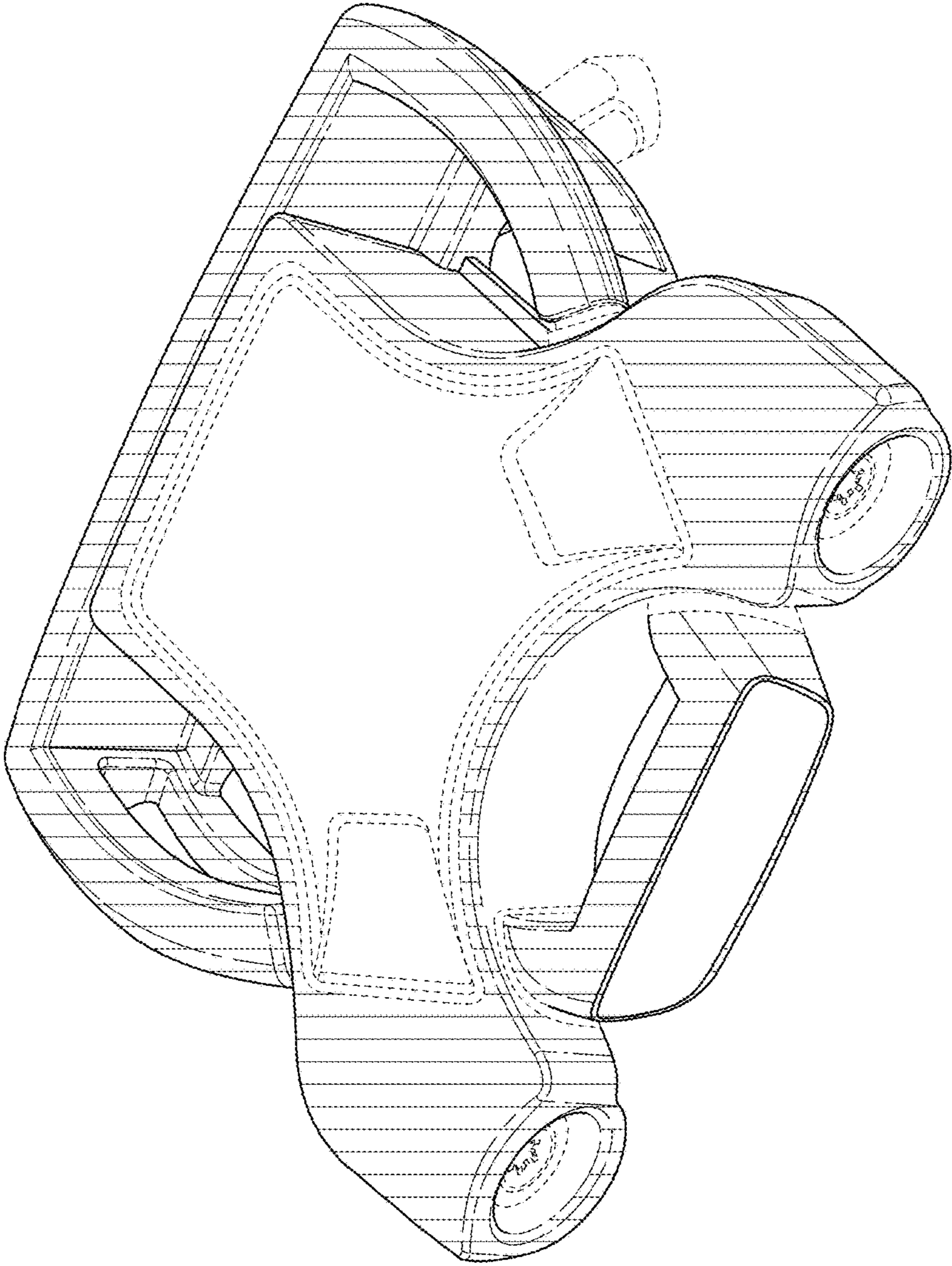

FIG. 2

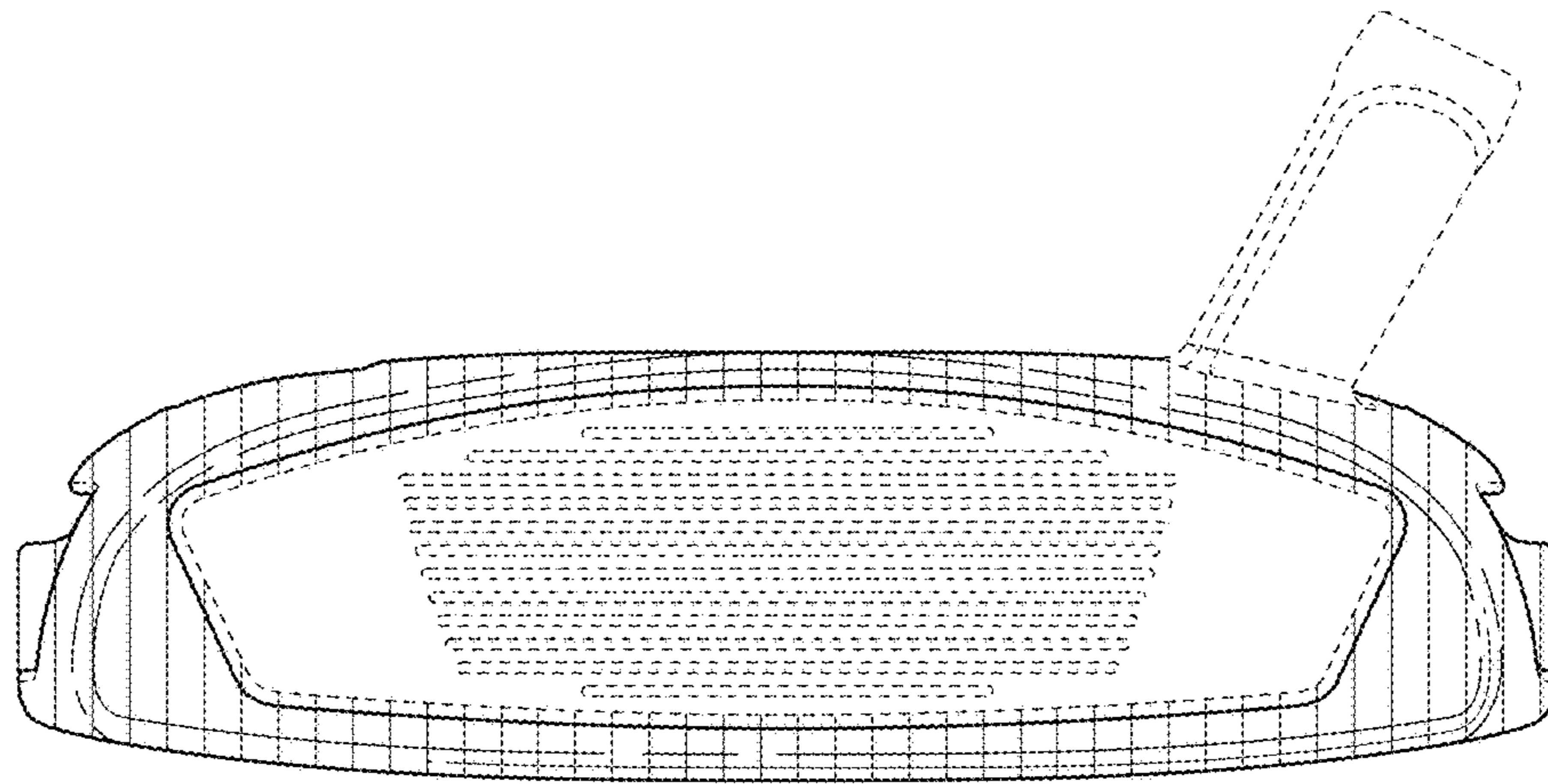

FIG. 3

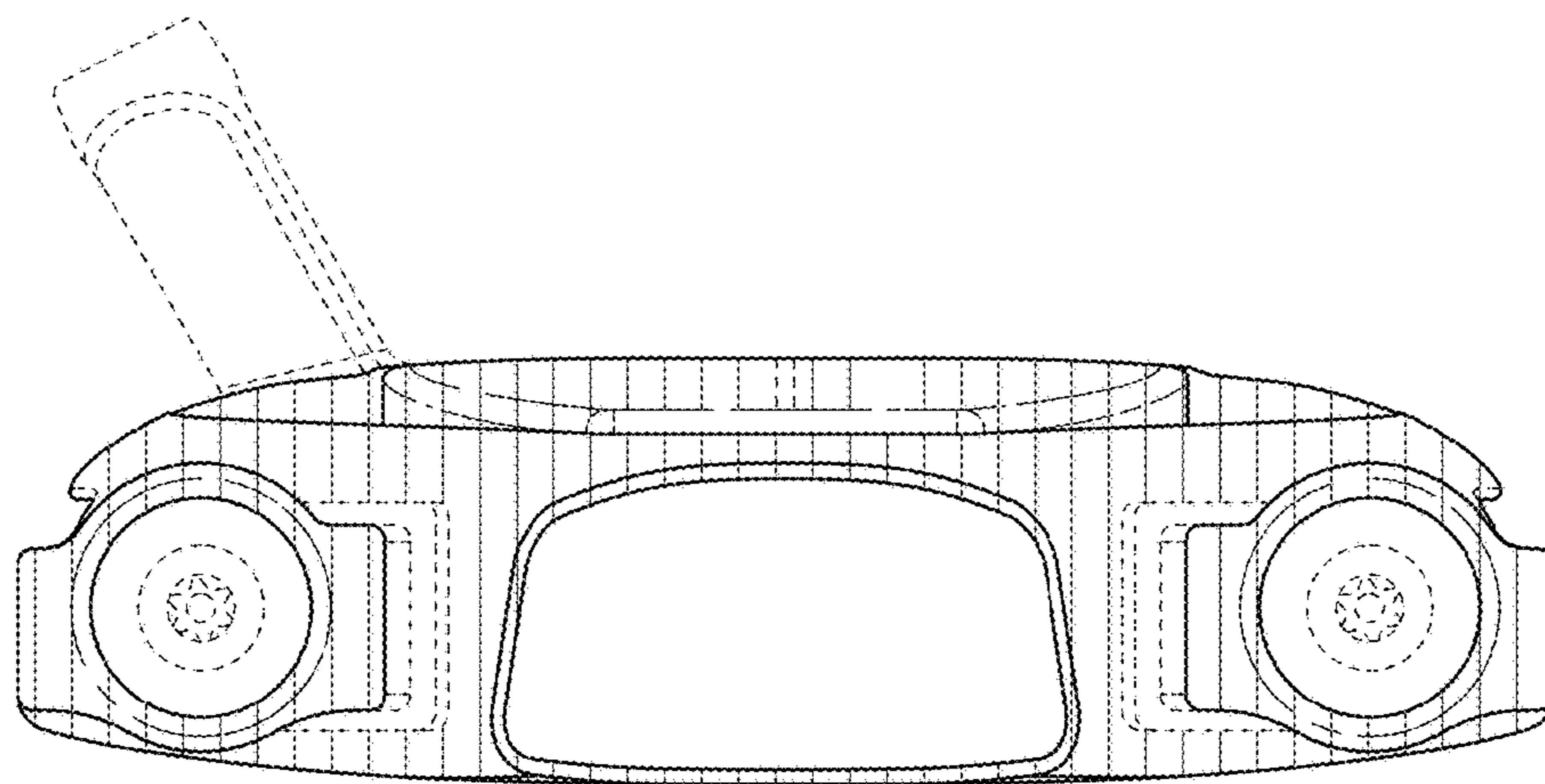

FIG. 4

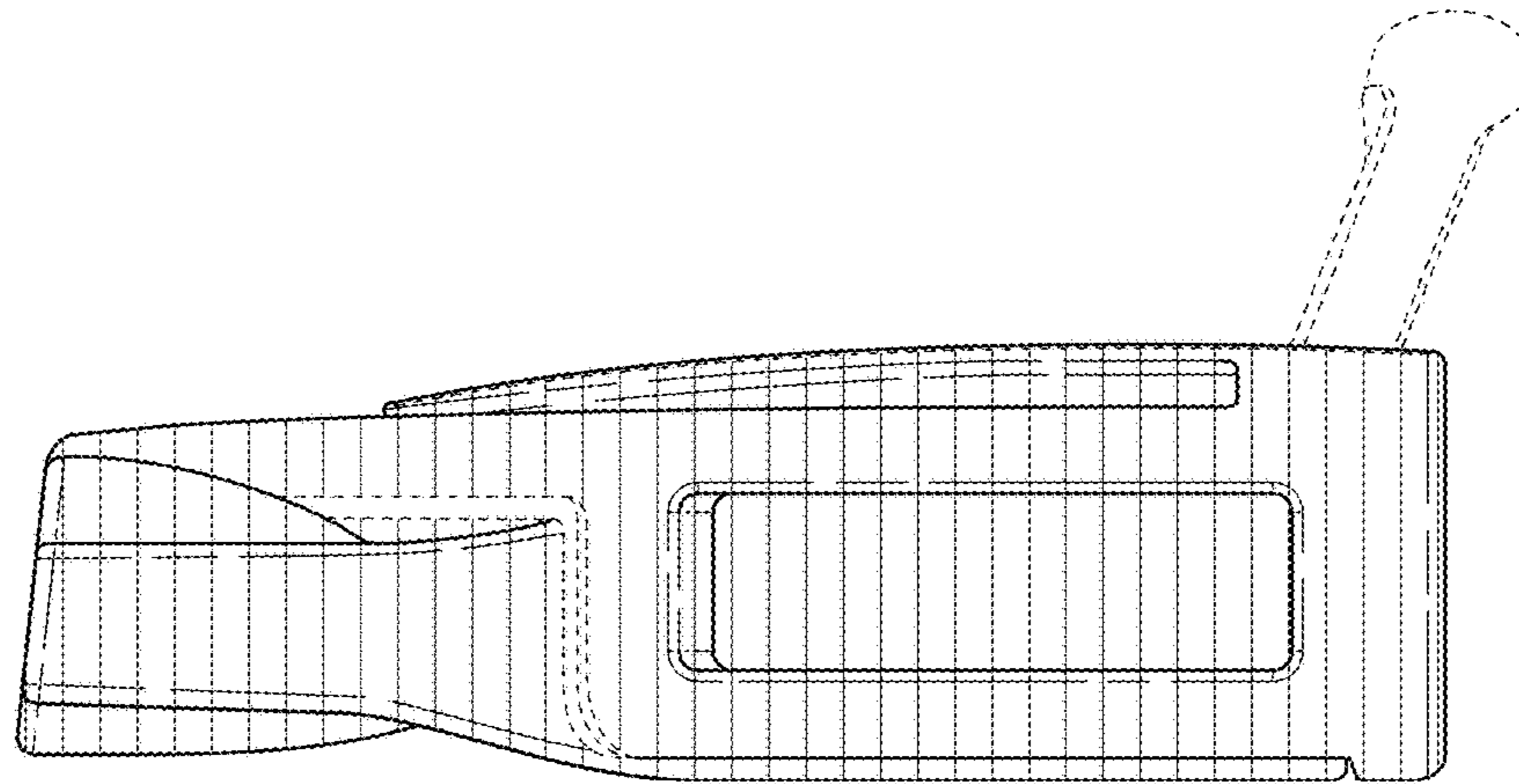

FIG. 5

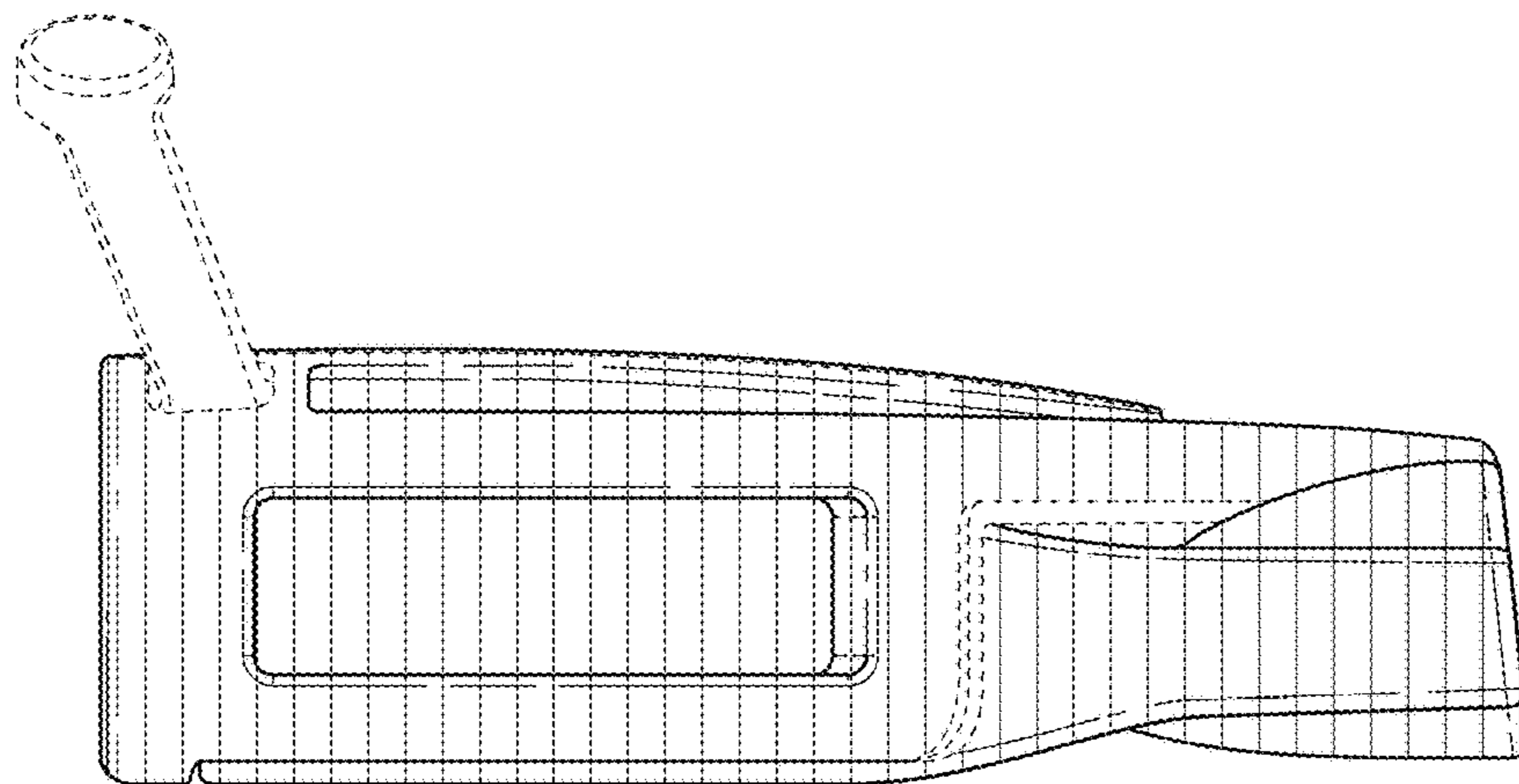

FIG. 6

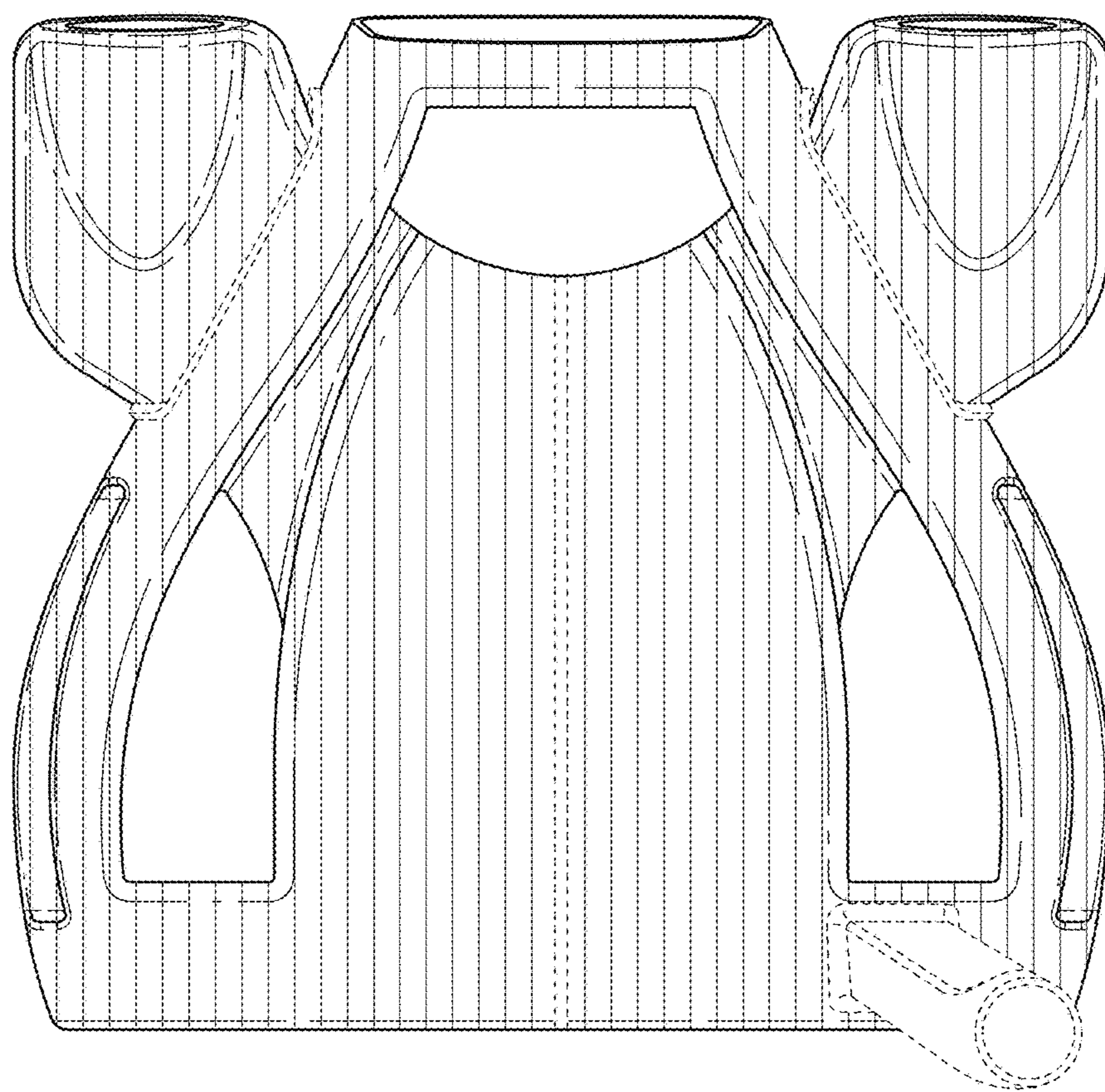

FIG. 7

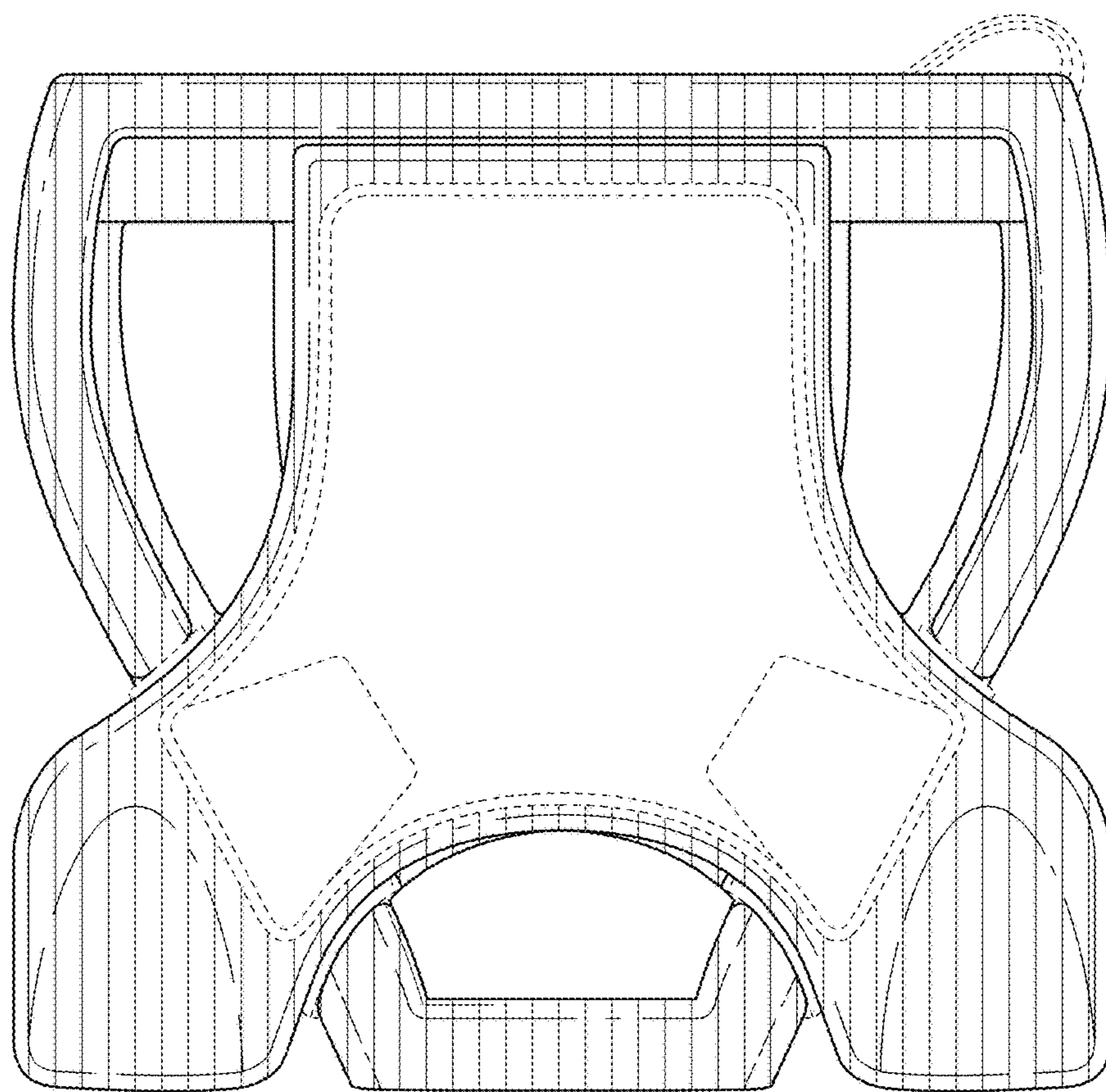

FIG. 8

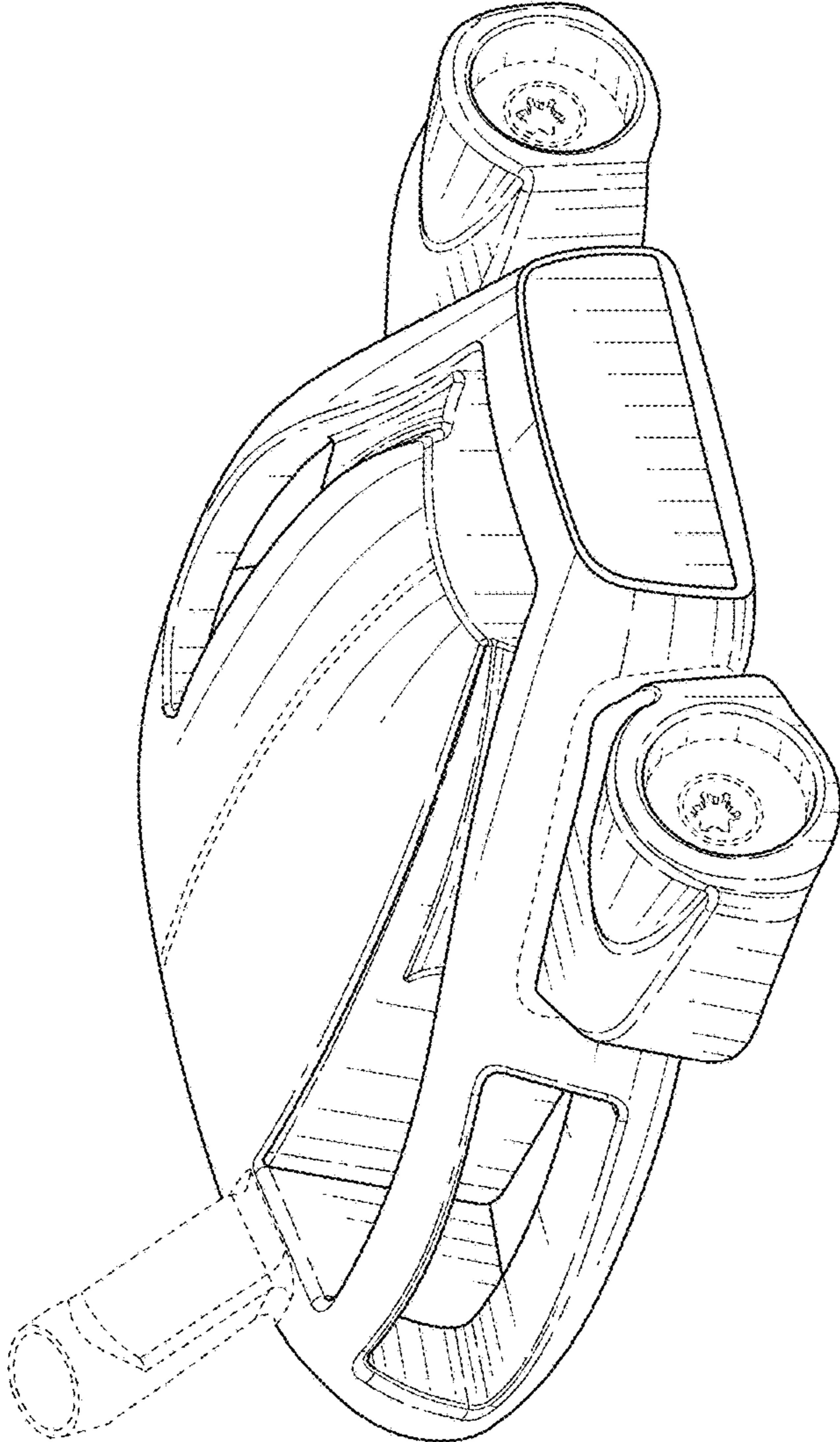

FIG. 9

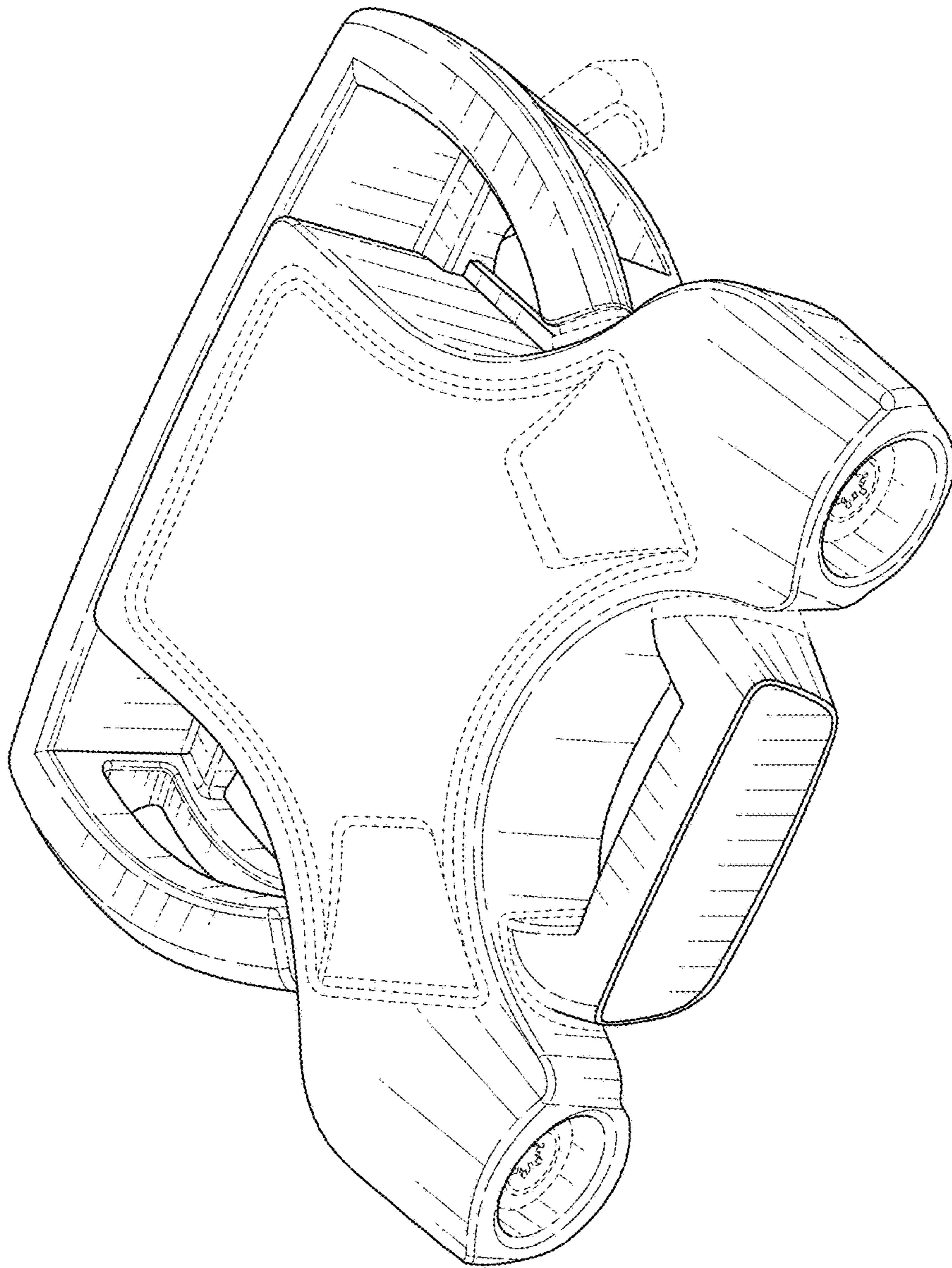

FIG. 10

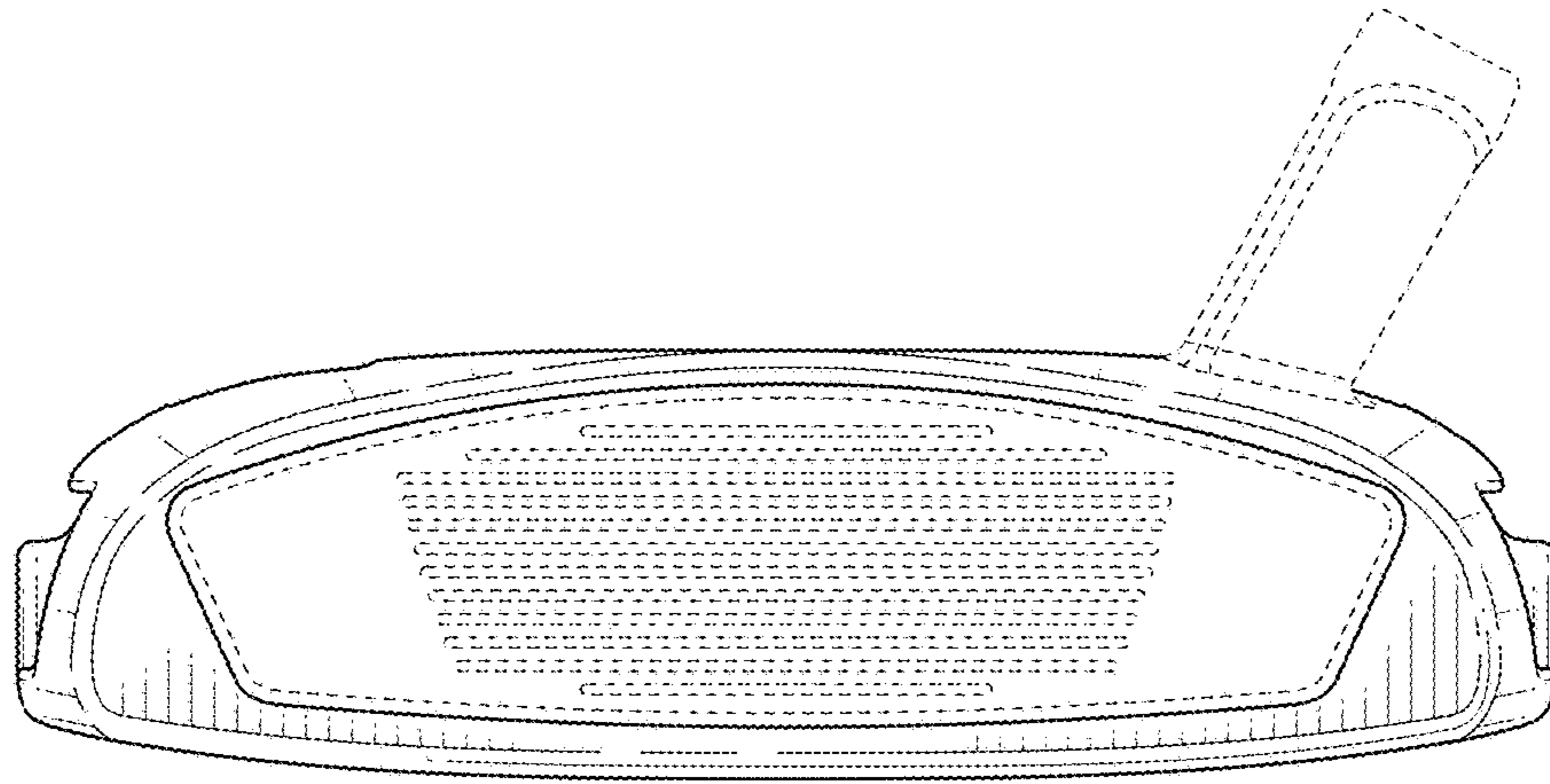

FIG. 11

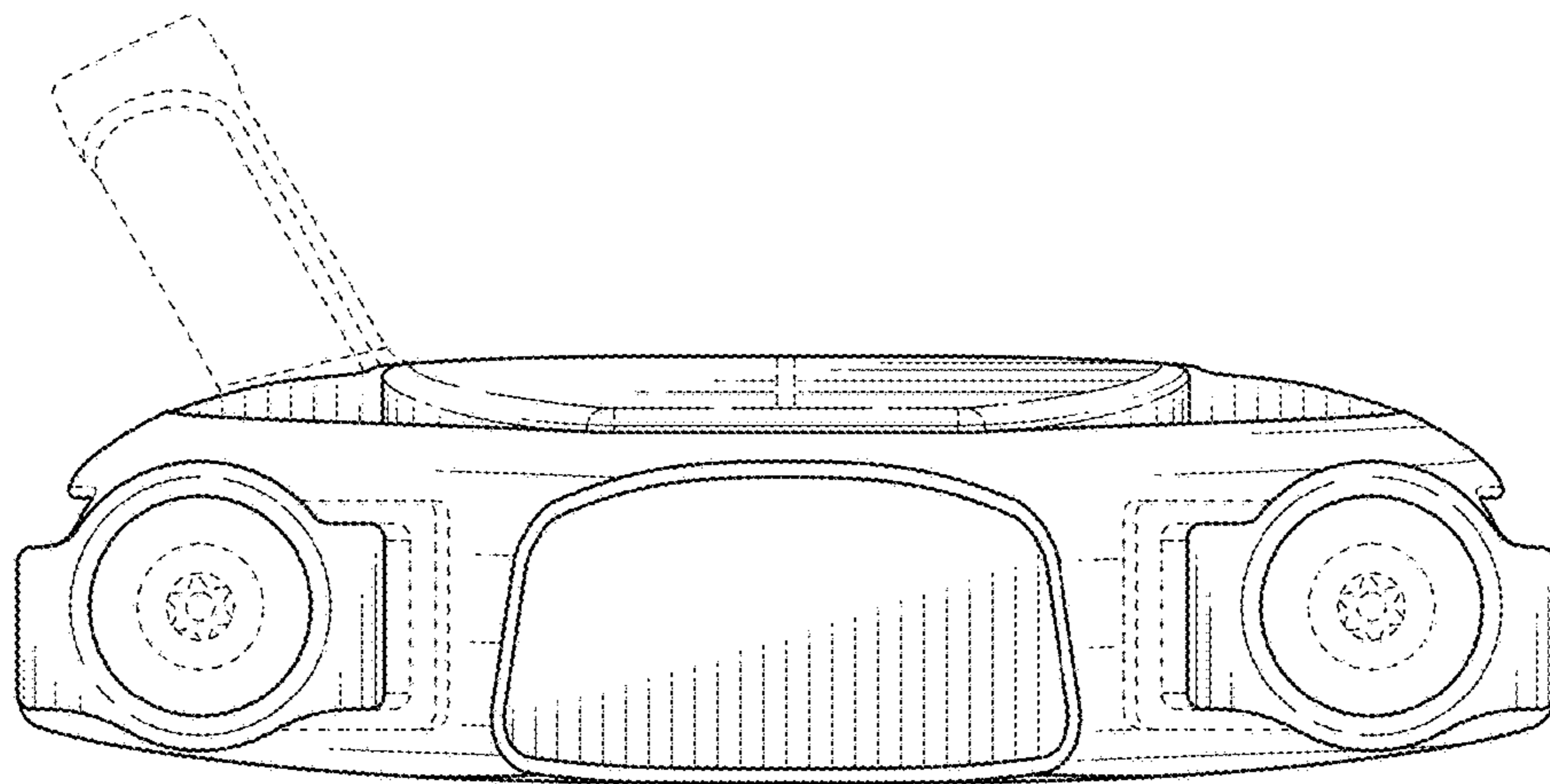

FIG. 12

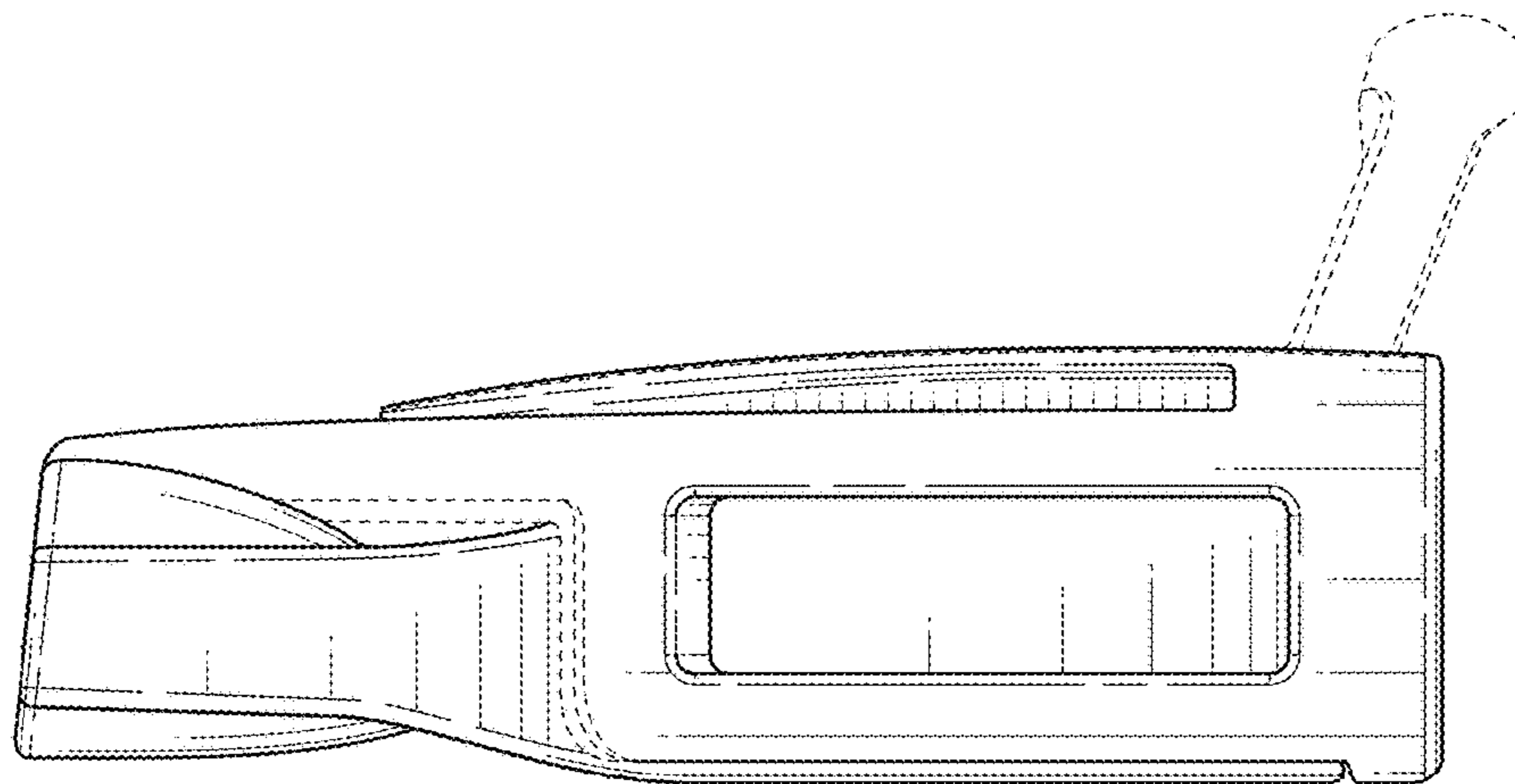

FIG. 13

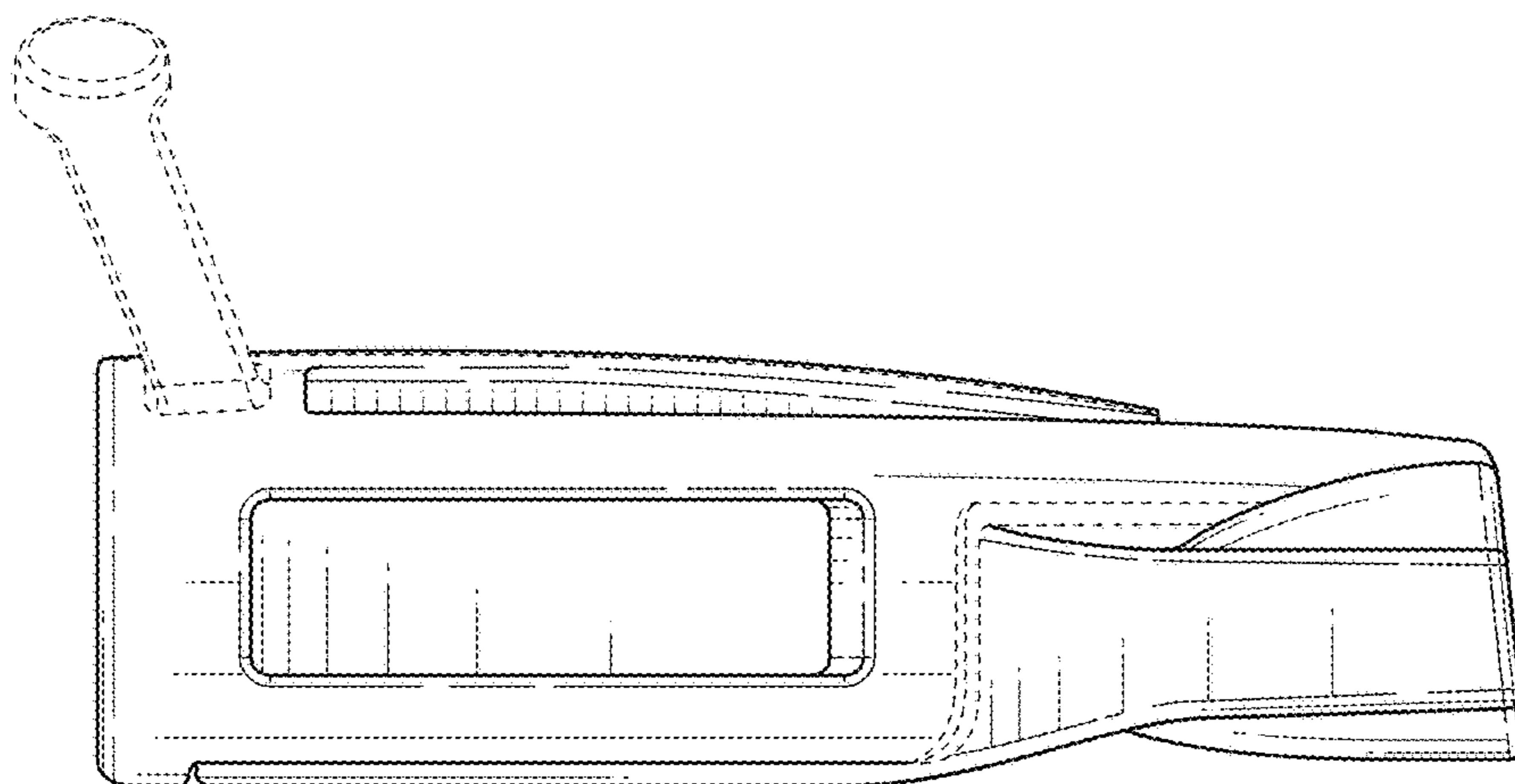

FIG. 14

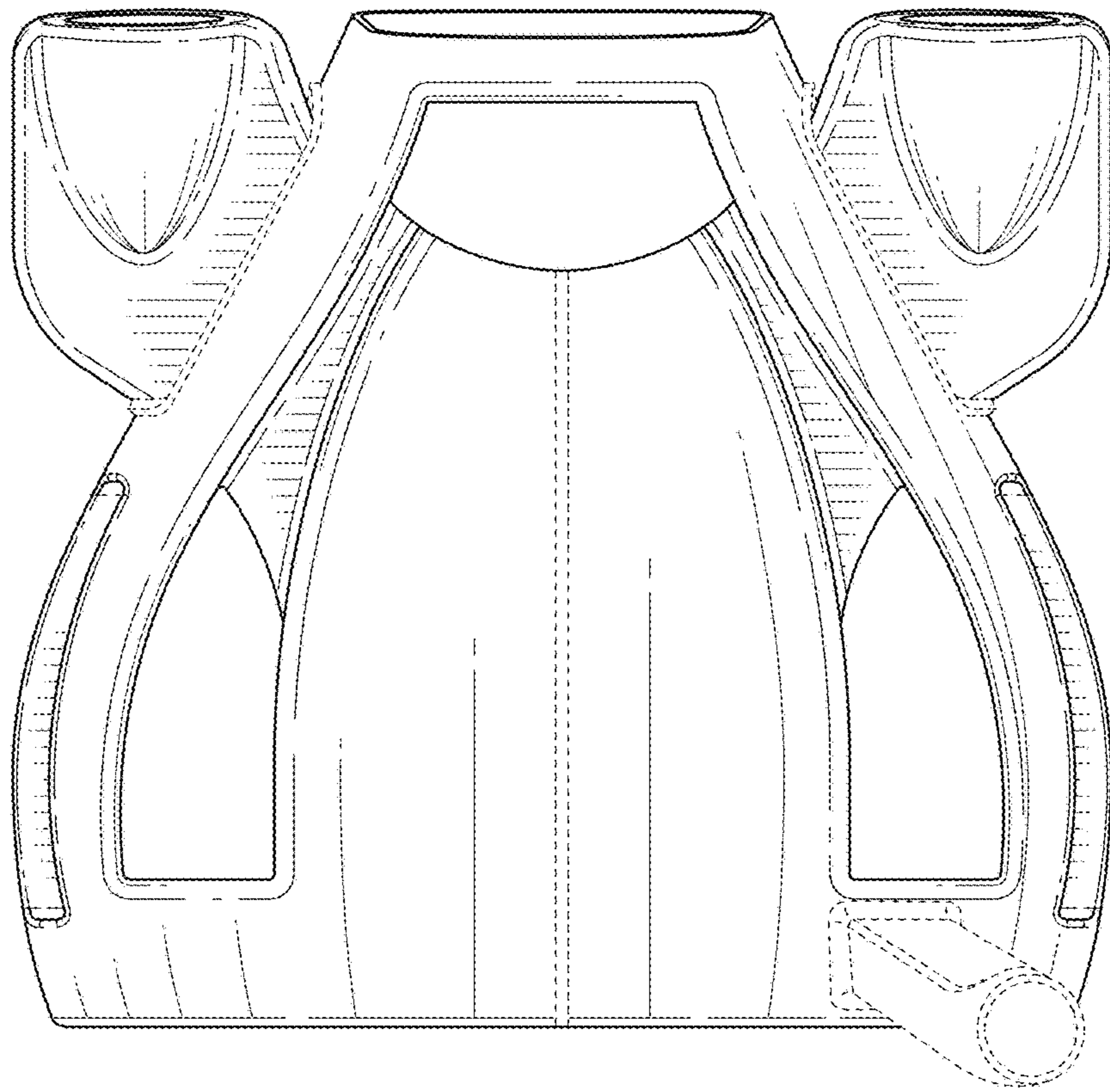

FIG. 15

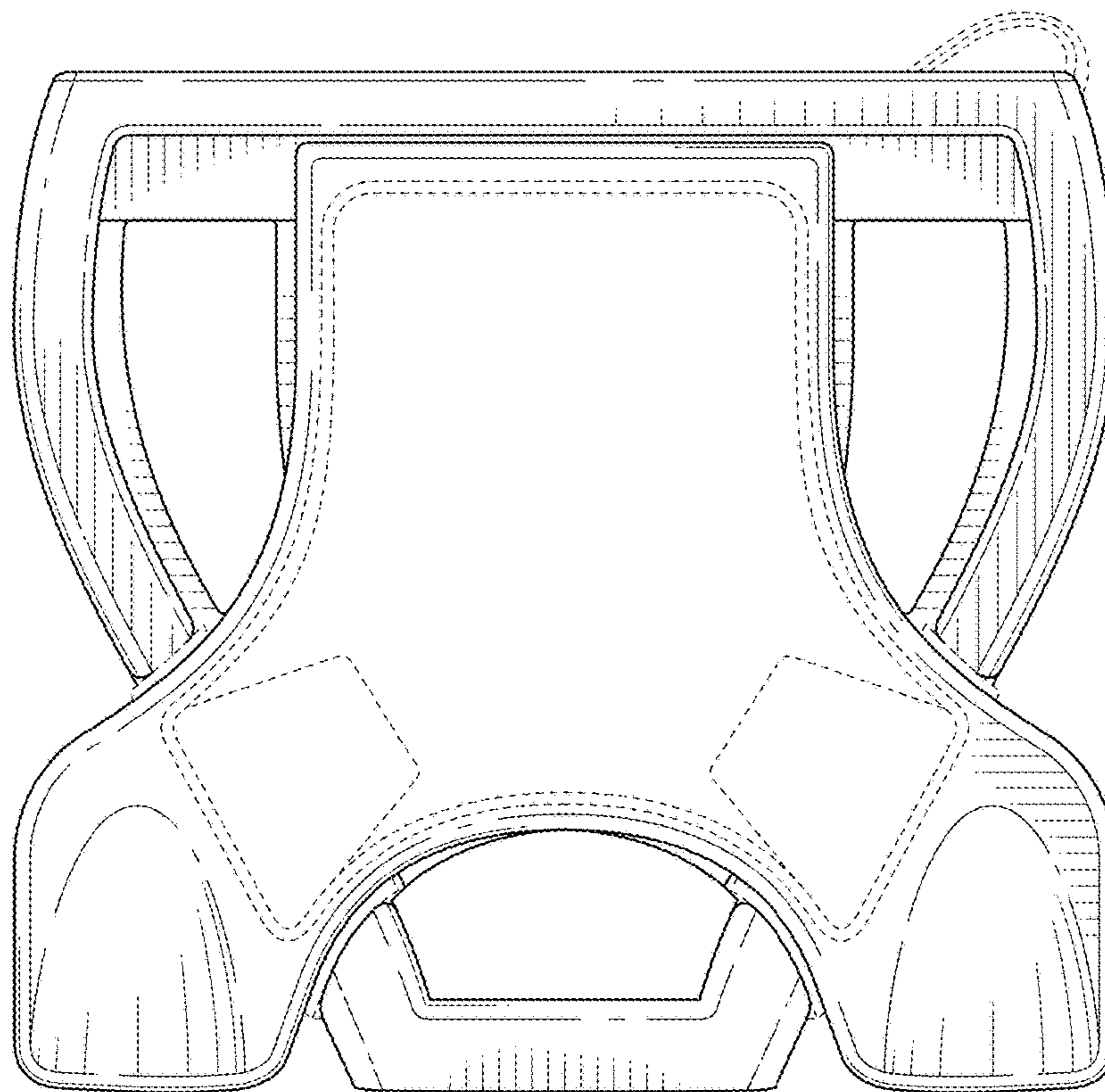

FIG. 16