



US00D837851S

(12) **United States Design Patent**
Schneider

(10) **Patent No.:** **US D837,851 S**

(45) **Date of Patent:** **** Jan. 8, 2019**

- (54) **RPM SENSOR FOR AN AUTOMATED CLUTCH SYSTEM**
- (71) Applicant: **Scott A. Schneider**, Evansville, IN (US)
- (72) Inventor: **Scott A. Schneider**, Evansville, IN (US)
- (**) Term: **15 Years**
- (21) Appl. No.: **29/594,457**
- (22) Filed: **Feb. 17, 2017**
- (51) **LOC (11) Cl.** **15-09**
- (52) **U.S. Cl.**
USPC **D15/148**
- (58) **Field of Classification Search**
USPC D12/177, 179; D15/148, 149, 199
CPC F16D 48/066; F16D 2500/1025; F16D 2500/1045; F16D 2500/5104; F16D 2500/7041; F16D 2500/10412; F16D 2500/50653; F16D 2500/50684; F16D 2500/70211; F16D 2500/70235; F16D 2500/70418
See application file for complete search history.

- D424,959 S * 5/2000 Hogan D10/106.1
- 6,250,448 B1 * 6/2001 Salecker B60K 28/165
192/103 F
- D466,846 S * 12/2002 Krivenkoff D12/180
- D634,573 S * 3/2011 Risher D6/580
- D661,630 S * 6/2012 Fehring D12/179
- D788,171 S * 5/2017 Itomi D12/124
- 2002/0060118 A1 * 5/2002 Beneton F16D 21/06
192/48.8
- 2003/0136627 A1 * 7/2003 Jung F16D 48/066
192/84.6
- 2003/0144110 A1 * 7/2003 Jung F16D 48/06
477/80
- 2004/0128050 A1 * 7/2004 Rieger F16D 48/06
701/67
- 2004/0157704 A1 * 8/2004 Stork B60W 10/02
477/166
- 2009/0227422 A1 * 9/2009 Fayyad F16H 61/143
477/176
- 2010/0155159 A1 * 6/2010 Burchett B60K 6/387
180/65.21

(Continued)

Primary Examiner — Patricia A Palasik
(74) *Attorney, Agent, or Firm* — Gary K. Price

(57) **CLAIM**

The ornamental design of an RPM sensor for an automated clutch system, as shown and described.

DESCRIPTION

FIG. 1 is a lower perspective view of an RPM sensor for an automated clutch system showing my new design.
FIG. 2 is a left side view thereof;
FIG. 3 is a front end view thereof;
FIG. 4 is a right side view thereof;
FIG. 5 is a back end view thereof;
FIG. 6 is a bottom view thereof;
FIG. 7 is a top view thereof; and,
FIG. 8 is a side sectional view thereof, taken from line 8-8 in FIG. 6.

1 Claim, 4 Drawing Sheets

(56) **References Cited**

U.S. PATENT DOCUMENTS

- 4,842,113 A * 6/1989 Lutz B60W 10/06
477/73
- 4,926,994 A * 5/1990 Koshizawa B60K 23/02
192/110 R
- D392,655 S * 3/1998 Mizukami D15/148
- 5,823,912 A * 10/1998 Fischer F16D 25/123
477/97
- 5,896,963 A * 4/1999 Schwientek B60W 30/18
192/3.62
- 5,982,280 A * 11/1999 Fahrbach F16D 48/066
340/453

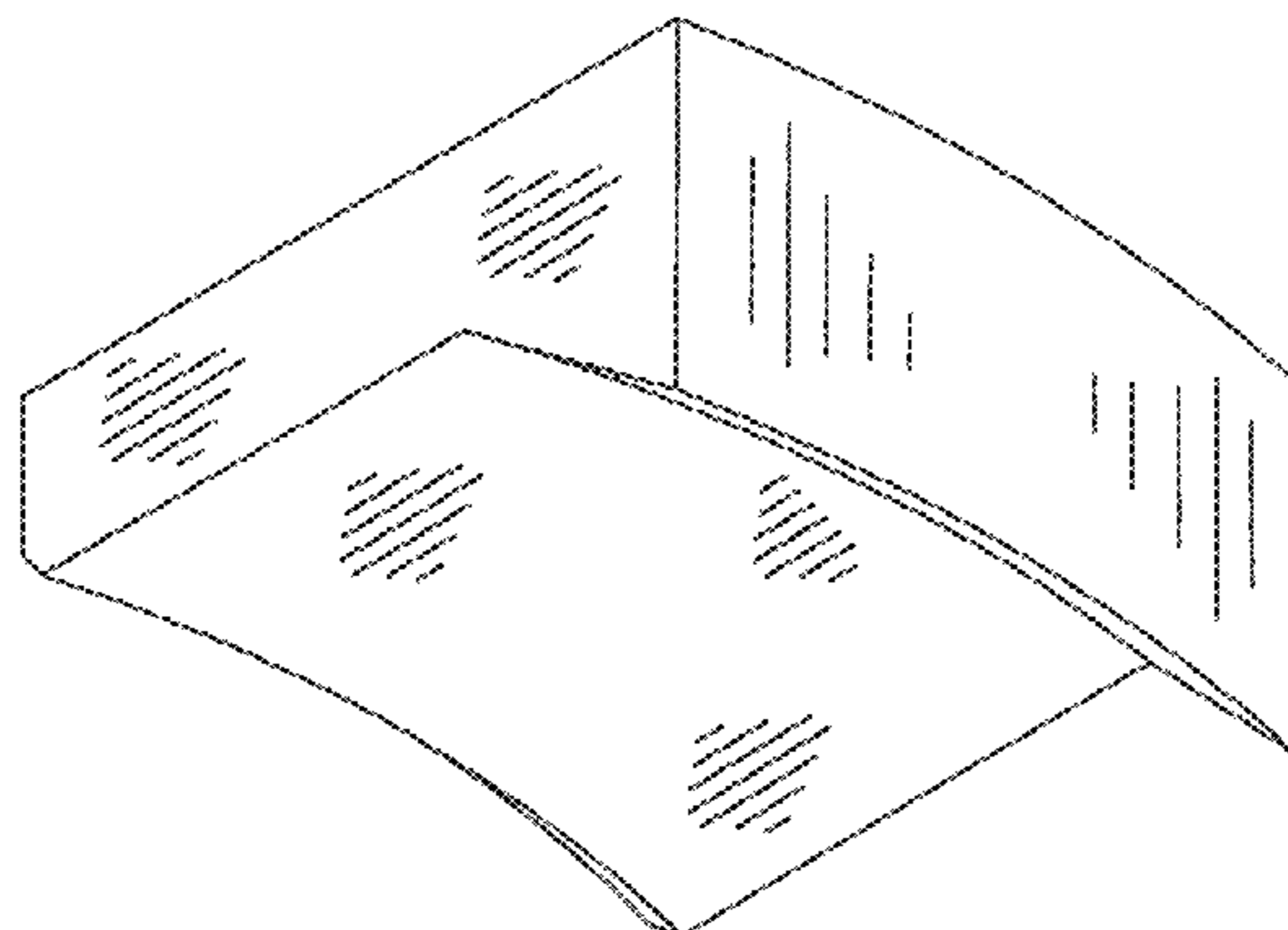

(56)

References Cited

U.S. PATENT DOCUMENTS

2010/0155160 A1* 6/2010 Burchett B60K 6/387
180/65.21
2011/0263383 A1* 10/2011 Ostberg F16H 61/688
477/174
2012/0029777 A1* 2/2012 Tao F16H 61/0213
701/60

* cited by examiner

FIG. 1

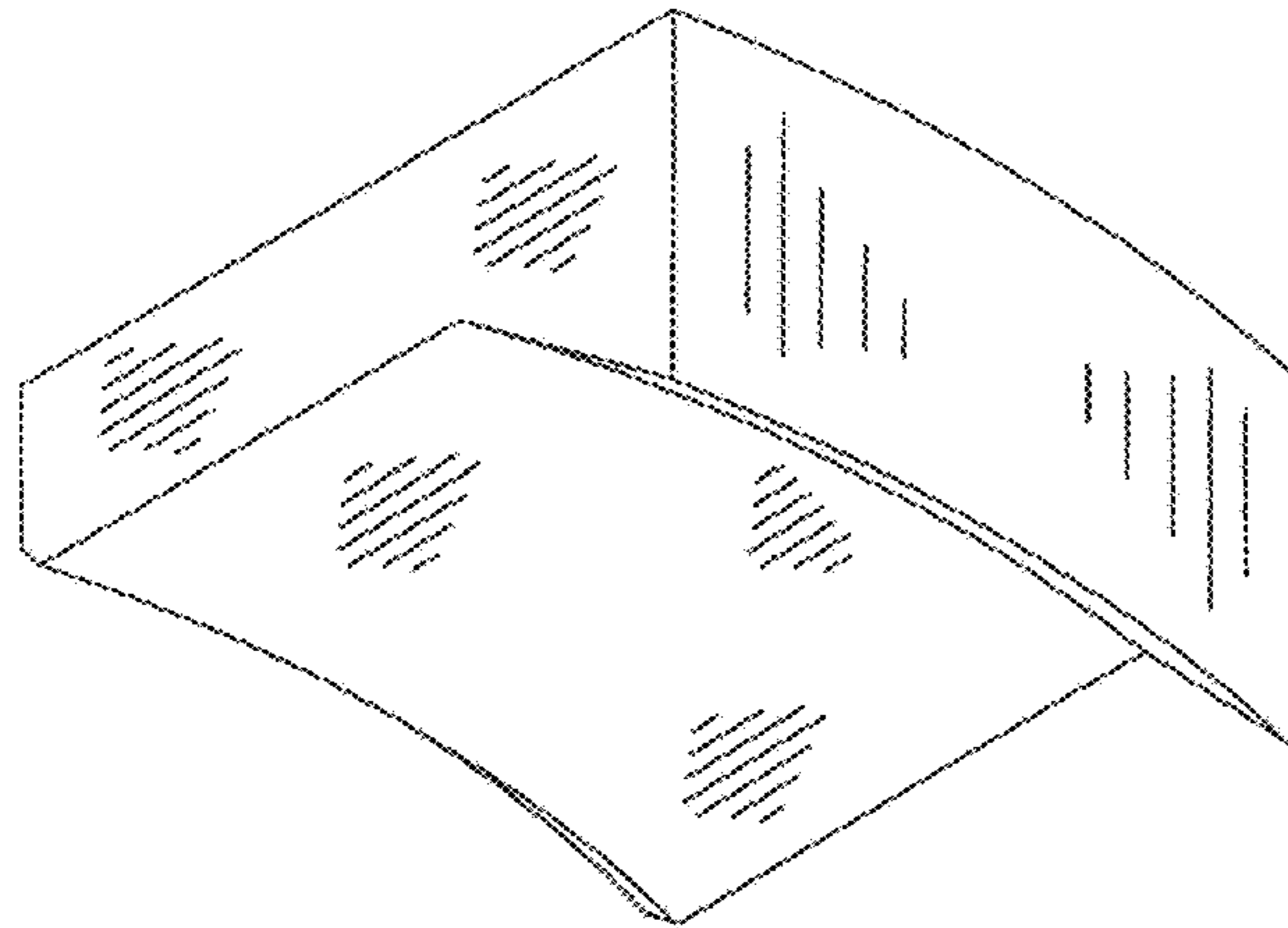

FIG. 2

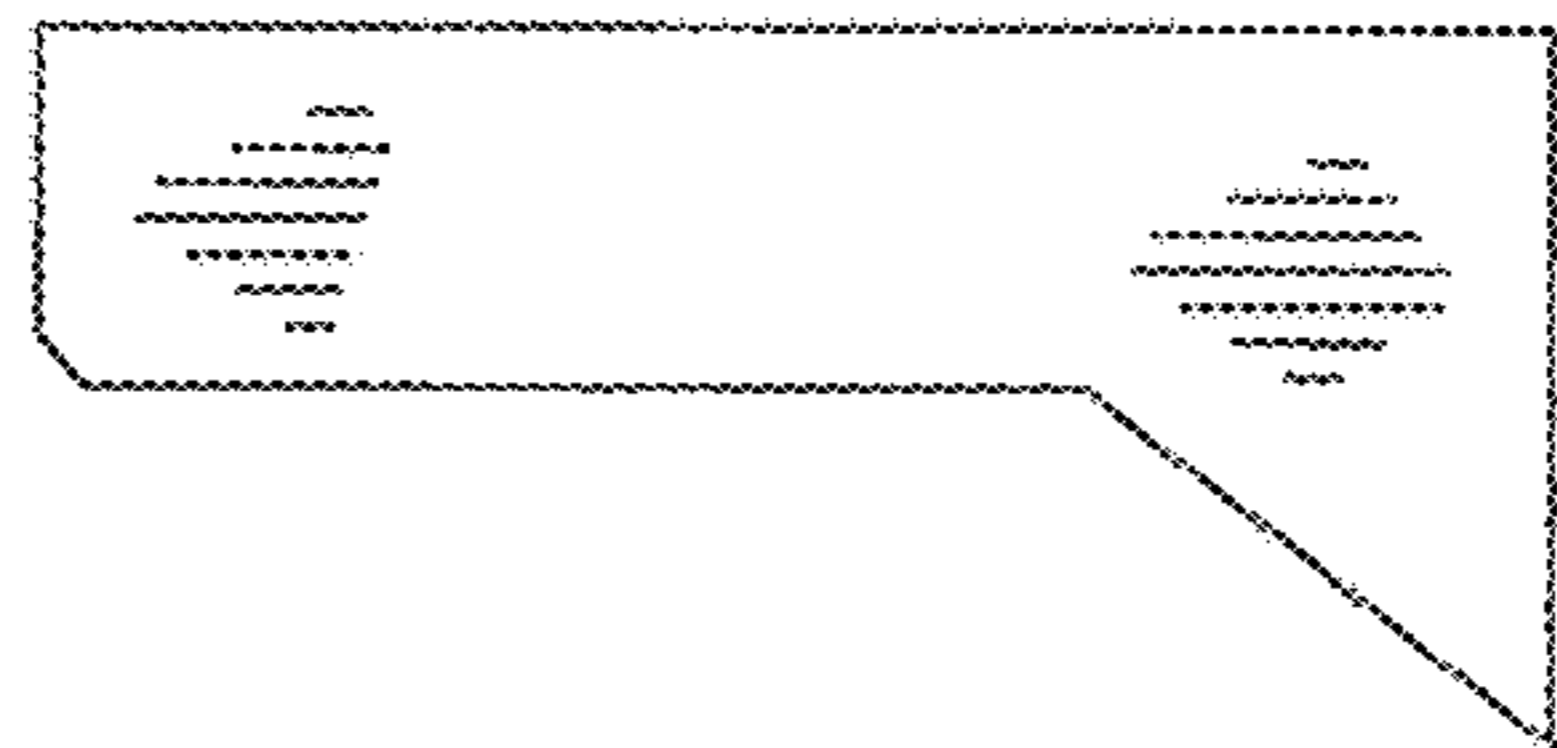

FIG. 3

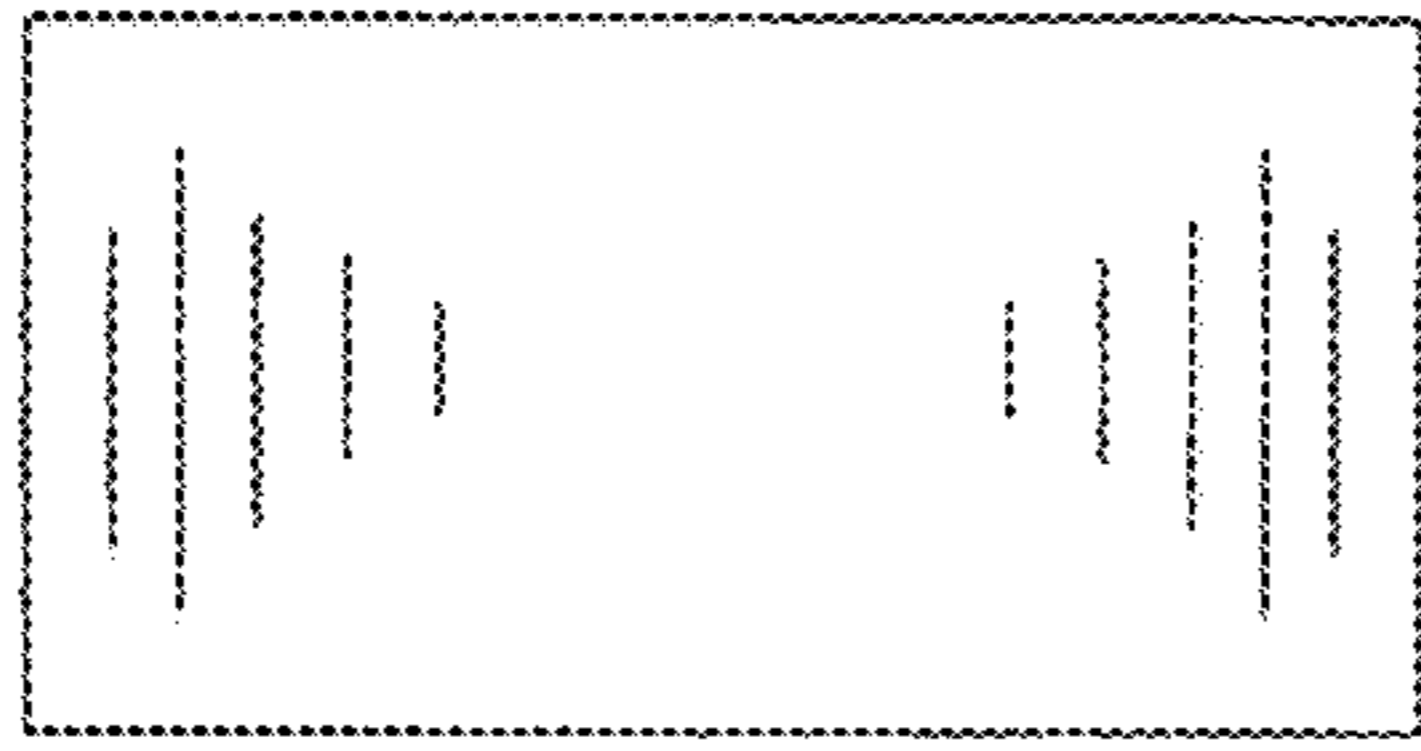

FIG. 4

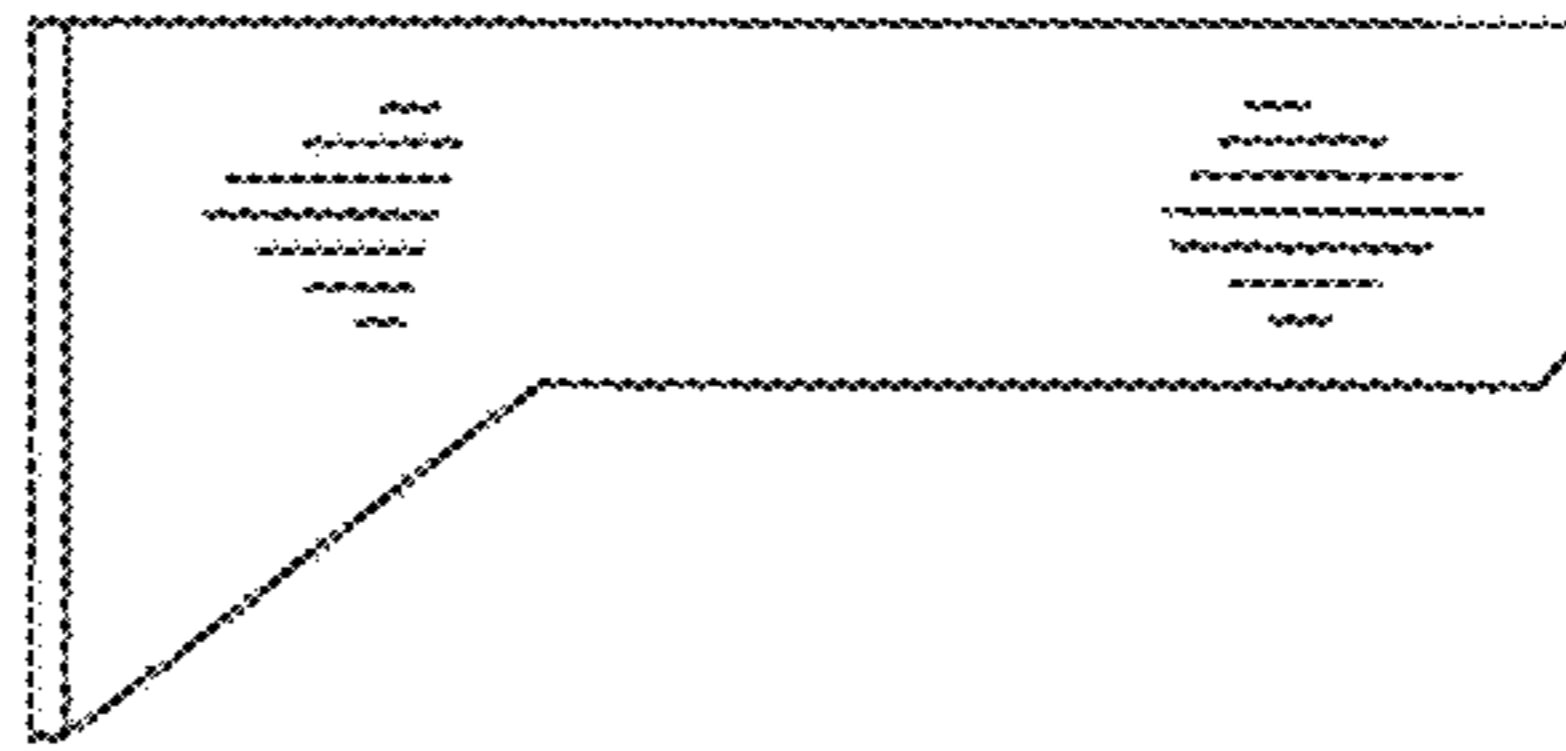

FIG. 5

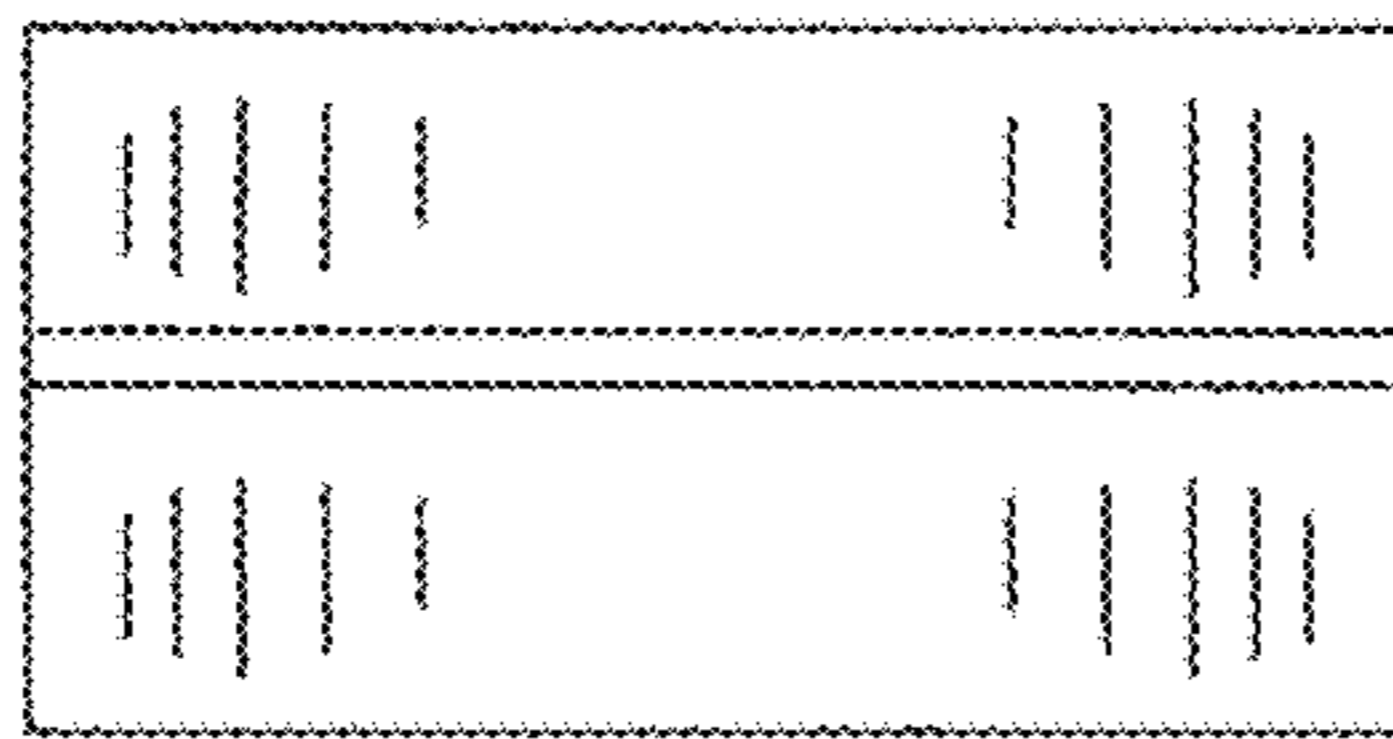

FIG. 6

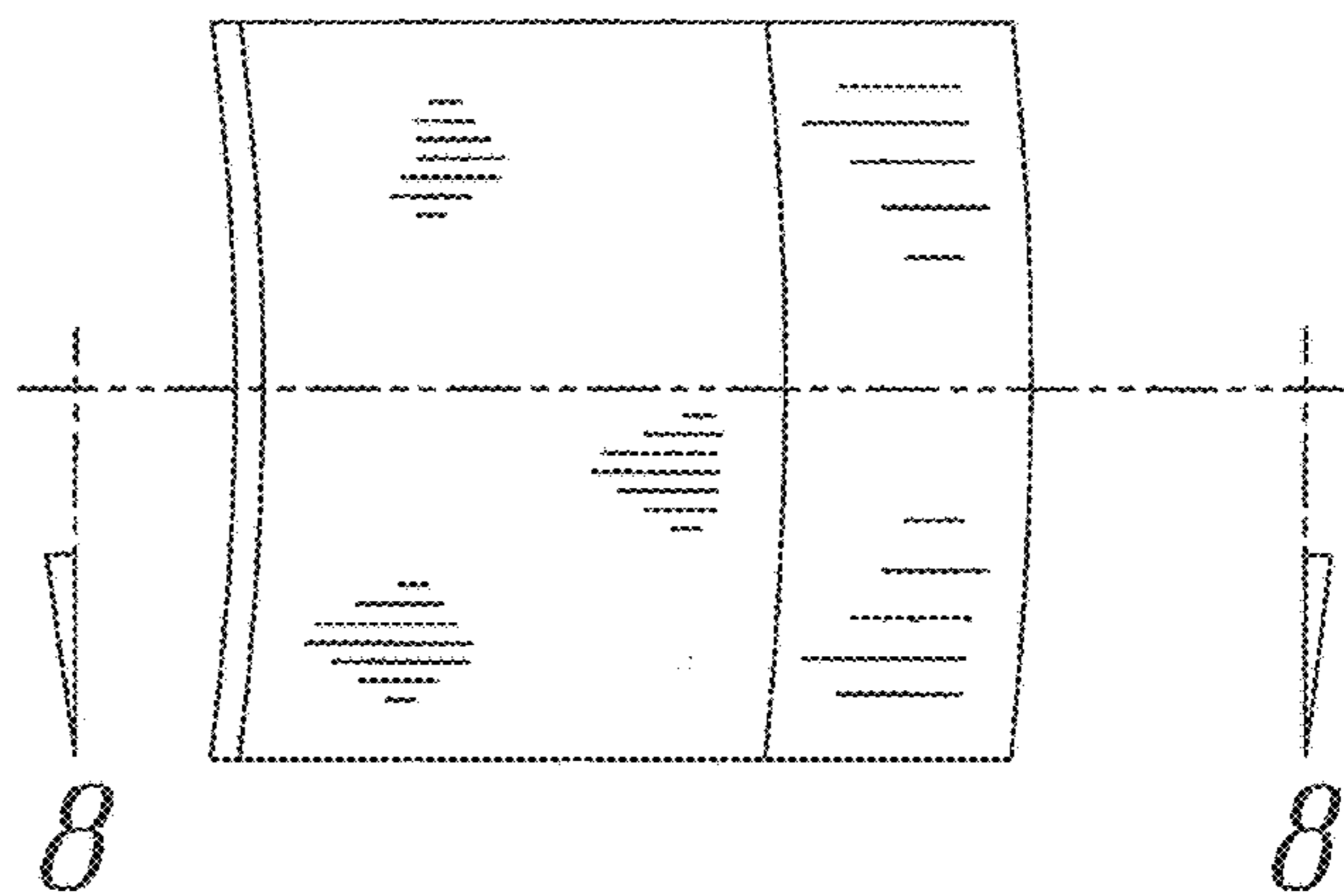

FIG. 7

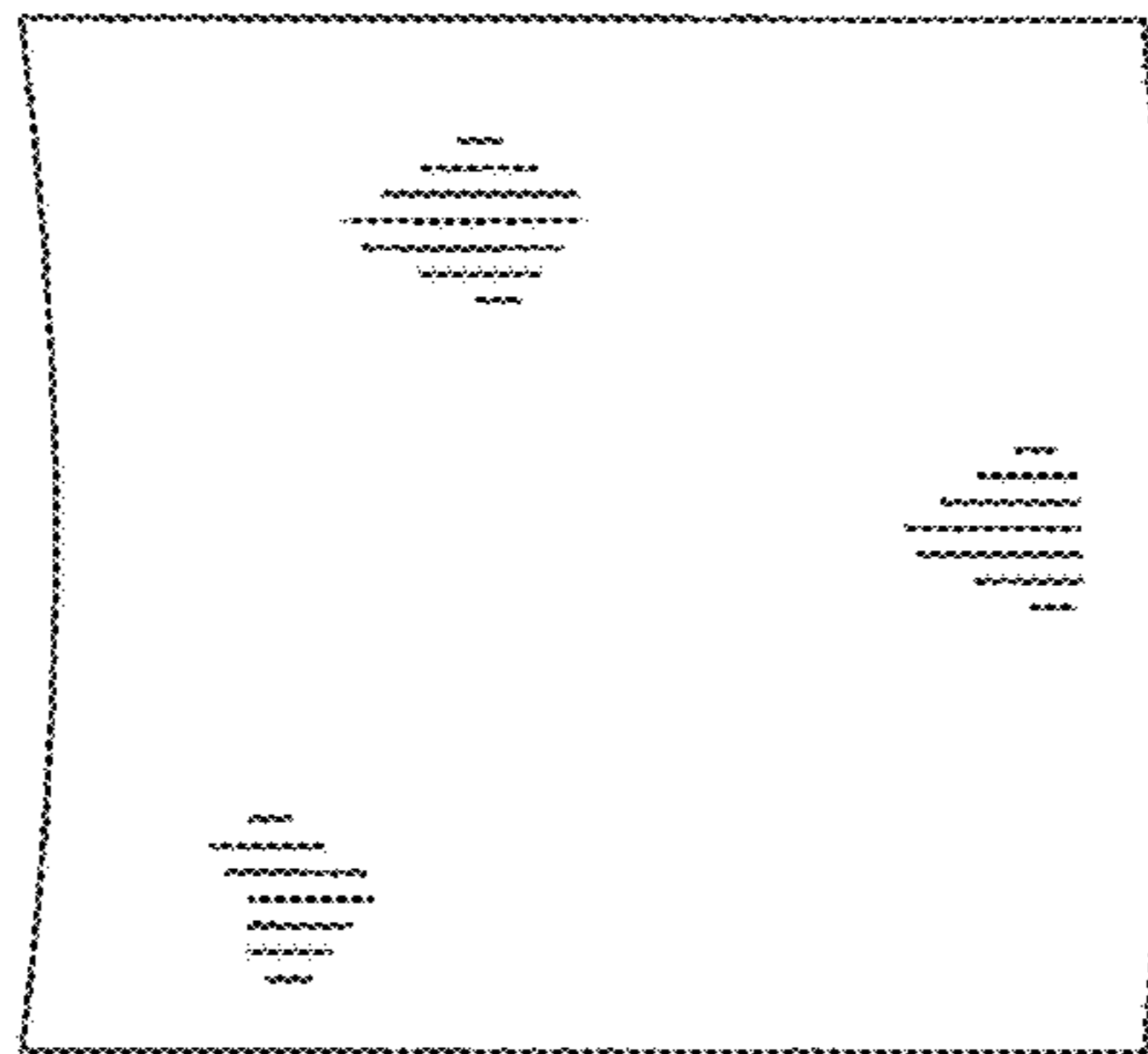

FIG. 8

