



US00D837794S

(12) **United States Design Patent** (10) **Patent No.:** **US D837,794 S**
Chan et al. (45) **Date of Patent:** **** Jan. 8, 2019**

(54) **DEVICE CASE WITH HANDLE**
(71) Applicant: **Pioneer Square Brands, Inc.**, Seattle, WA (US)
(72) Inventors: **Jaimie Emerald Chan**, Renton, WA (US); **Michael Cooper Ferren**, Seattle, WA (US)
(73) Assignee: **PIONEER SQUARE BRANDS, INC.**, McLean, VA (US)

D691,146 S * 10/2013 Perez D14/440
D694,246 S * 11/2013 Park D14/440
D703,672 S * 4/2014 Kim D14/440
8,690,210 B1 * 4/2014 May A45F 5/00
224/217
D705,767 S * 5/2014 Yoon D14/250
D712,412 S * 9/2014 Bleau D14/440
D721,075 S * 1/2015 Toda D14/342
D721,376 S * 1/2015 Lee D14/440
D725,659 S * 3/2015 Tussy D14/440
D727,917 S * 4/2015 Yeo D14/440
D733,154 S * 6/2015 Armstrong D14/440

(Continued)

(**) Term: **15 Years**

Primary Examiner — Cynthia R Underwood
(74) *Attorney, Agent, or Firm* — Grandview Law

(21) Appl. No.: **29/630,019**

(22) Filed: **Dec. 18, 2017**

(51) **LOC (11) Cl.** **14-02**

(52) **U.S. Cl.**
USPC **D14/440**

(58) **Field of Classification Search**
USPC D14/440; 206/45.23, 320, 45.2;
361/679.55; 294/25; 224/218
CPC ... G06F 1/1628; G06F 1/1626; A47B 23/044;
H04B 1/3888; H05K 5/0217
See application file for complete search history.

(56) **References Cited**

U.S. PATENT DOCUMENTS

6,726,070 B2 * 4/2004 Lautner A44C 5/0007
224/221
D492,303 S * 6/2004 Schlieffers D14/341
D591,801 S * 5/2009 Mak D21/469
D594,004 S * 6/2009 Takemasa D14/341
D611,467 S * 3/2010 Gou D14/315
D613,285 S * 4/2010 Grant D14/341
D626,123 S * 10/2010 Peng D14/324
D676,449 S * 2/2013 Probst D14/440
D685,376 S * 7/2013 Kim D14/439
D689,056 S * 9/2013 Li D14/440
D690,704 S * 10/2013 Padilla D14/440
D691,144 S * 10/2013 Peters D14/440

(57) **CLAIM**

The ornamental design for a device case with handle, as shown and described.

DESCRIPTION

FIG. 1 is a top perspective view of a first embodiment thereof.
FIG. 2 is a top plan view thereof.
FIG. 3 is a bottom plan view thereof.
FIG. 4 is a front elevation view thereof.
FIG. 5 is a rear elevational view thereof.
FIG. 6 is a left elevational view thereof.
FIG. 7 is a right elevational view thereof.
FIG. 8 is a top perspective view of a second embodiment thereof.
FIG. 9 is a top plan view thereof.
FIG. 10 is a bottom plan view thereof.
FIG. 11 is a front elevation view thereof.
FIG. 12 is a rear elevational view thereof.
FIG. 13 is a left elevational view thereof; and,
FIG. 14 is a right elevational view thereof.
The features shown in broken lines in the drawing figures depict features that form no part of the claimed design.

1 Claim, 6 Drawing Sheets

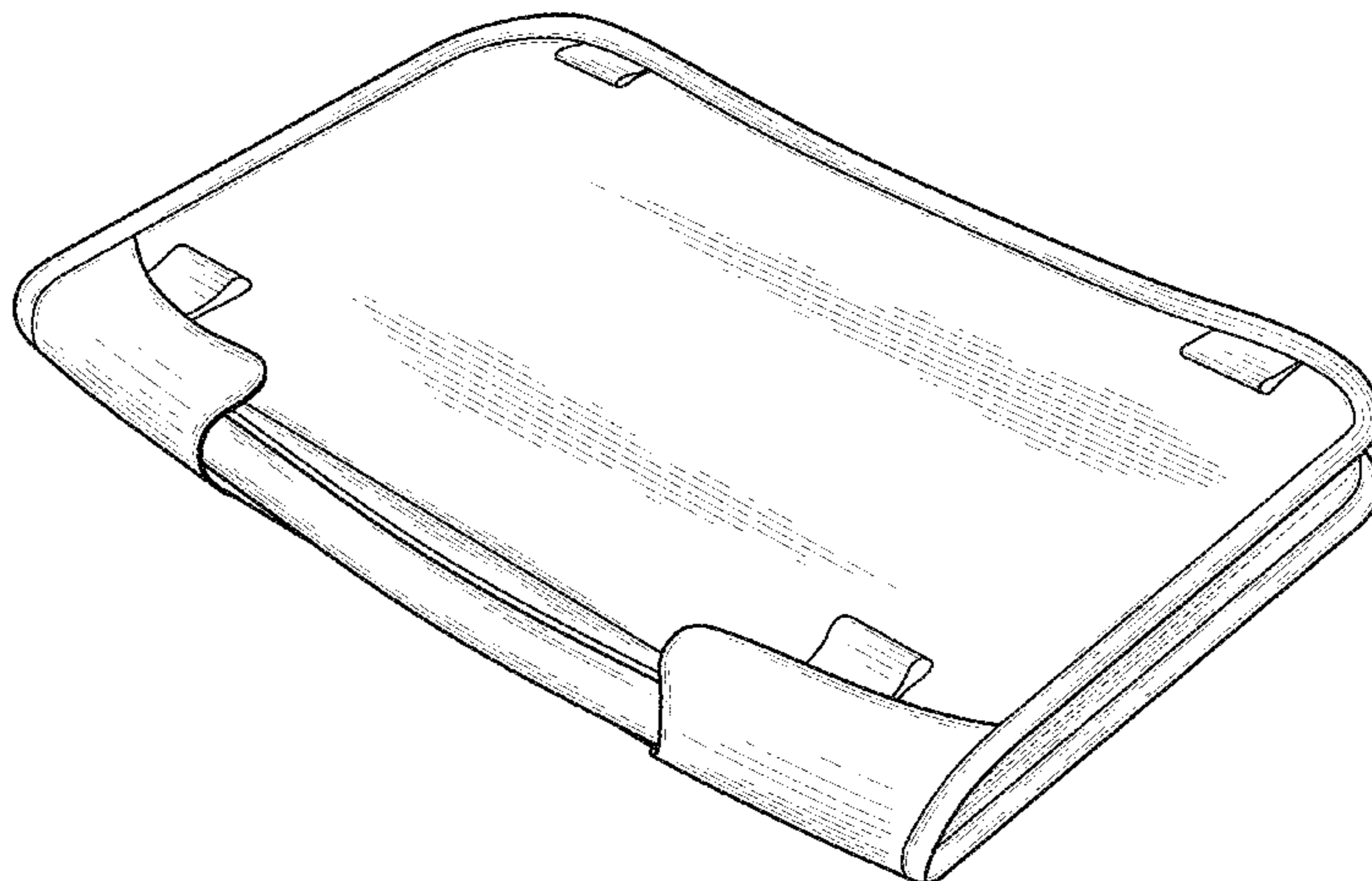

(56)

References Cited

U.S. PATENT DOCUMENTS

| | | | | | | | |
|------------------|---------|-----------------|------------------------|------------------|---------|----------------------|--------------------------|
| D741,335 S * | 10/2015 | Bastian | D14/440 | 2007/0215512 A1* | 9/2007 | Bellissimo | A47G 23/0625 206/557 |
| D747,321 S * | 1/2016 | London | D14/440 | 2009/0219677 A1* | 9/2009 | Mori | A45F 3/14 361/679.03 |
| D749,592 S * | 2/2016 | Huang | D14/440 | 2011/0267748 A1* | 11/2011 | Lane | A45F 5/00 361/679.01 |
| D752,052 S * | 3/2016 | Park | D14/440 | 2011/0309117 A1* | 12/2011 | Roberts | A45F 5/00 224/217 |
| D754,666 S * | 4/2016 | Tiffen | D14/440 | 2012/0091312 A1* | 4/2012 | Baker | F16M 13/00 248/682 |
| D763,853 S * | 8/2016 | Pearce | D14/440 | 2014/0054910 A1* | 2/2014 | Kim | H04B 1/385 294/158 |
| D765,085 S * | 8/2016 | Moore | D14/440 | 2014/0152034 A1* | 6/2014 | Tussy | F16M 13/04 294/142 |
| 9,407,743 B1* | 8/2016 | Hirshberg | H04M 1/04 | 2015/0009610 A1* | 1/2015 | London | G06F 1/163 361/679.03 |
| D766,249 S * | 9/2016 | Veltz | D14/440 | 2015/0068934 A1* | 3/2015 | Armstrong | A45C 11/00 206/320 |
| D771,030 S * | 11/2016 | Tussy | D14/250 | 2015/0201743 A1* | 7/2015 | Erickson-Davis | A45F 5/00 224/218 |
| D784,350 S * | 4/2017 | Li | D14/440 | 2017/0045920 A1* | 2/2017 | Armstrong | G06F 1/1669 |
| D794,007 S * | 8/2017 | Zhang | D14/250 | | | | |
| D794,625 S * | 8/2017 | Armstrong | D14/250 | | | | |
| D797,106 S * | 9/2017 | Paolizzi | D14/426 | | | | |
| D803,222 S * | 11/2017 | Cheng | D14/440 | | | | |
| D806,083 S * | 12/2017 | Armstrong | D14/440 | | | | |
| D807,366 S * | 1/2018 | Chen | D14/440 | | | | |
| D817,316 S * | 5/2018 | Srouer | D14/251 | | | | |
| D821,405 S * | 6/2018 | Chen | D14/440 | | | | |
| 2004/0226973 A1* | 11/2004 | Kao | F16M 11/041 224/218 | | | | |

* cited by examiner

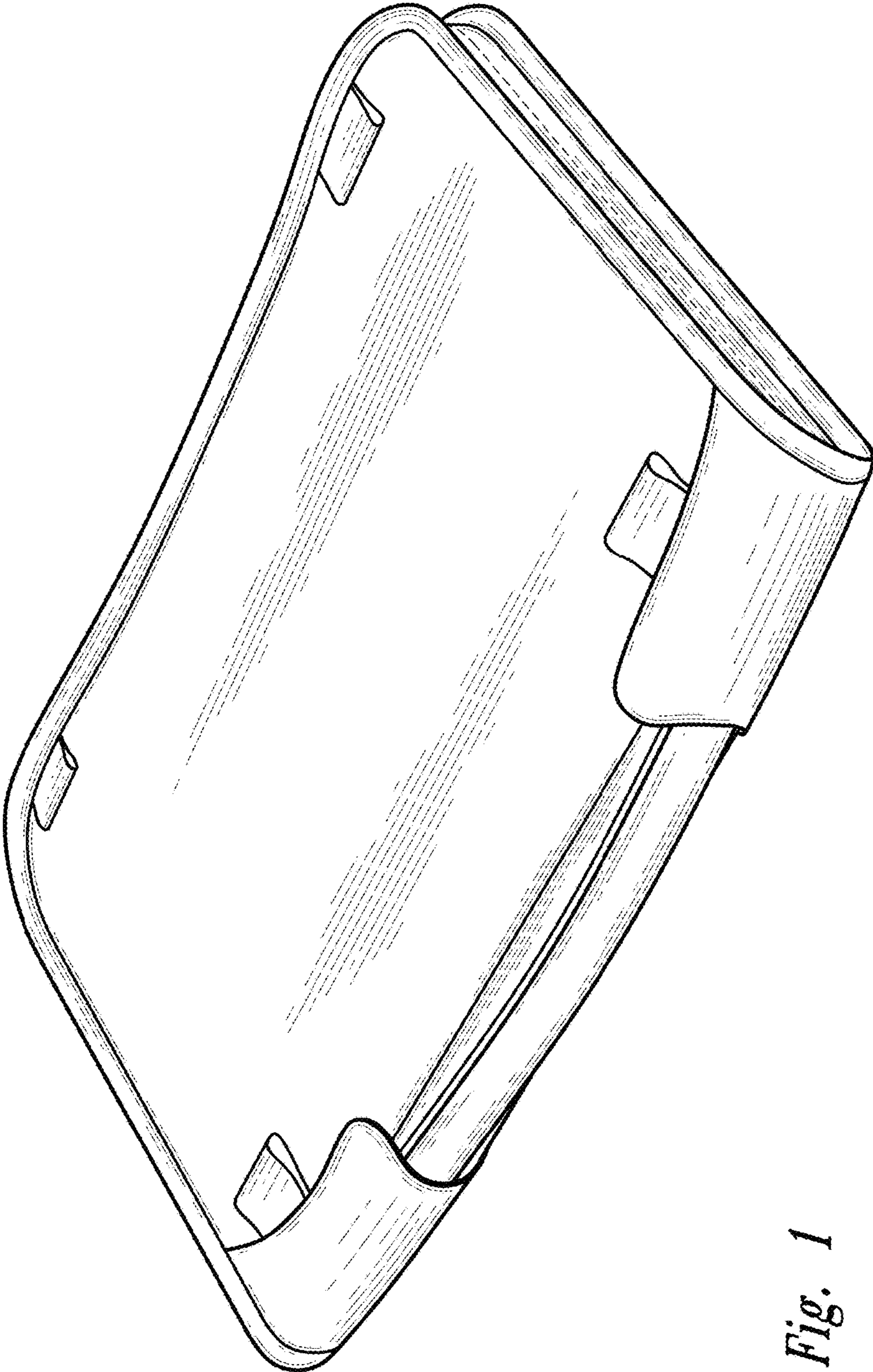

Fig. 1

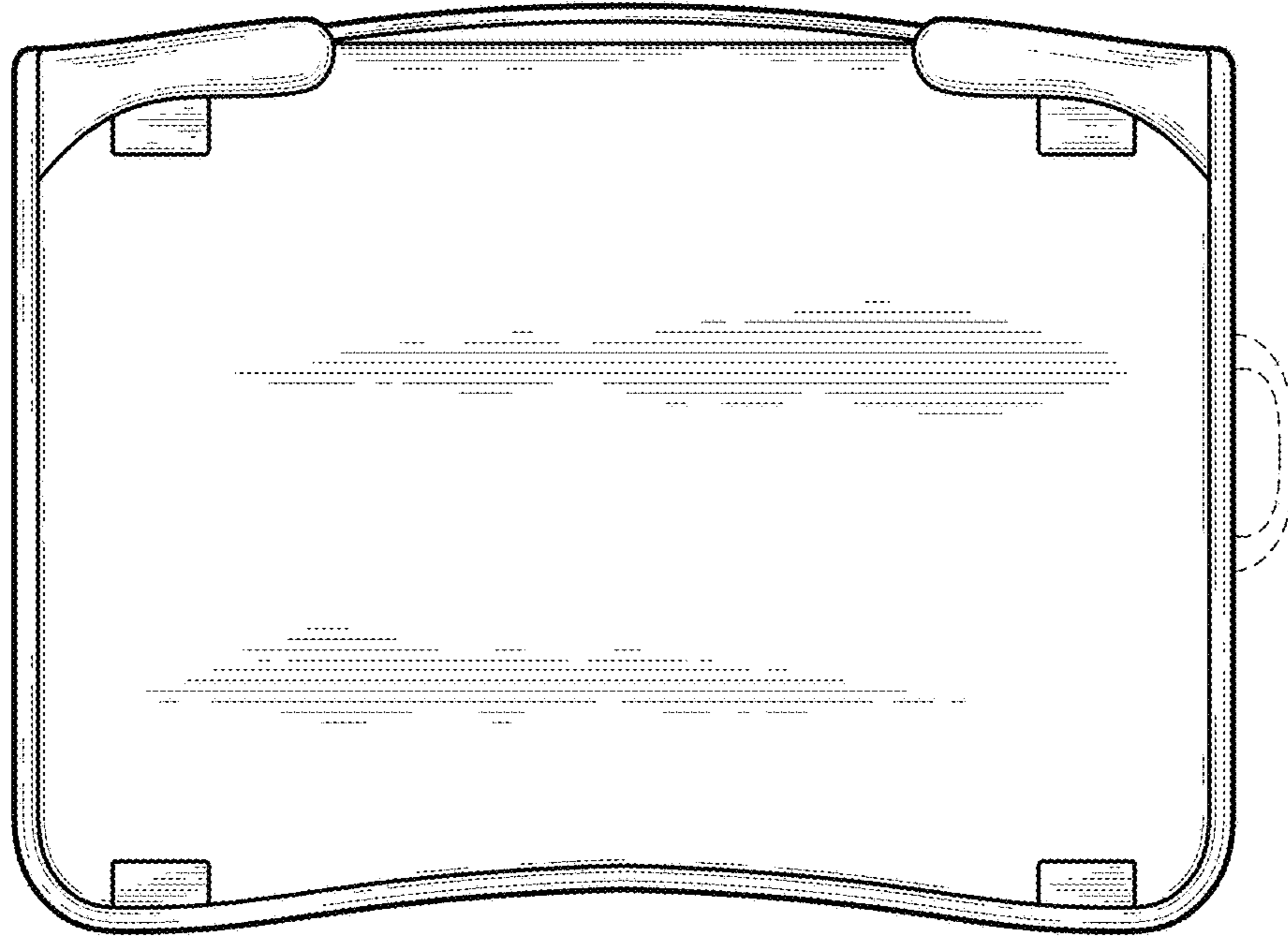

Fig. 2

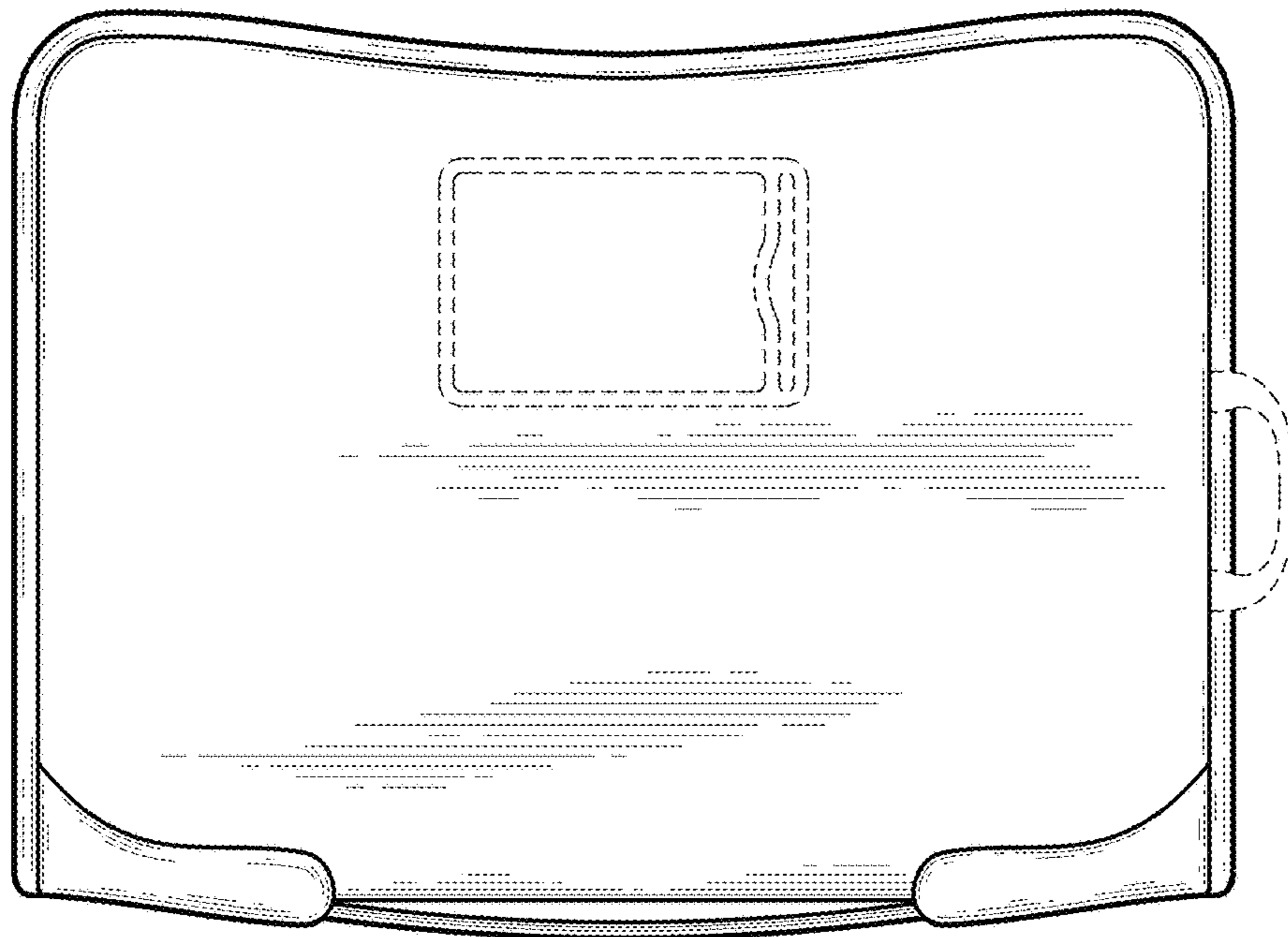

Fig. 3

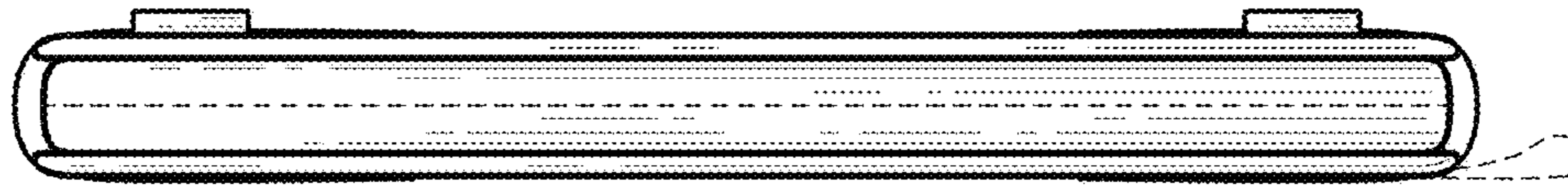

Fig. 4

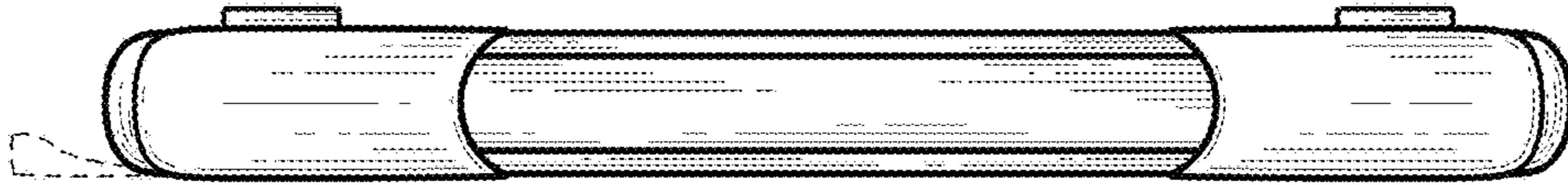

Fig. 5

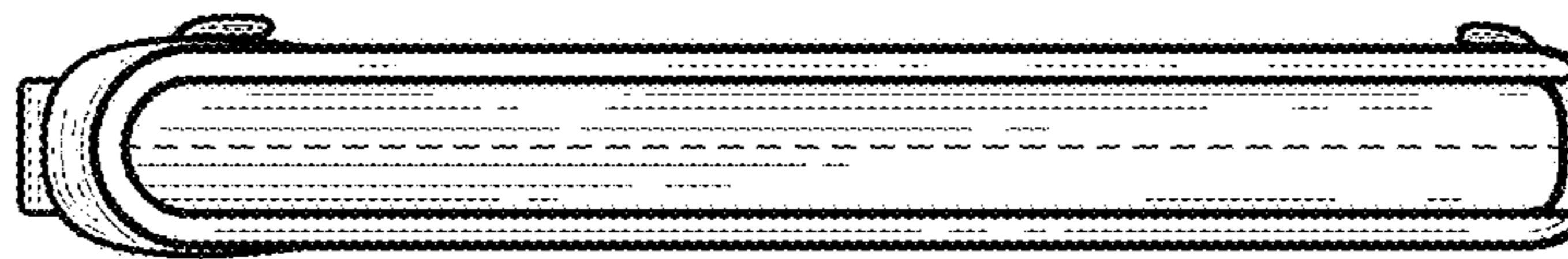

Fig. 6

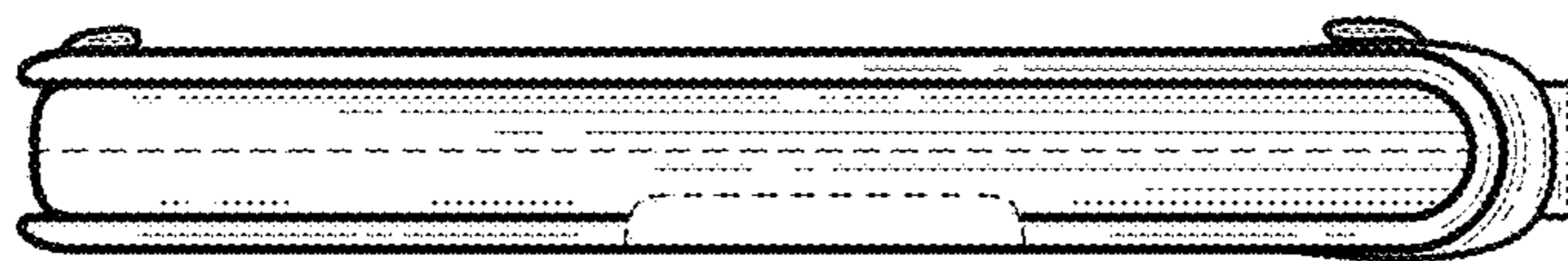

Fig. 7

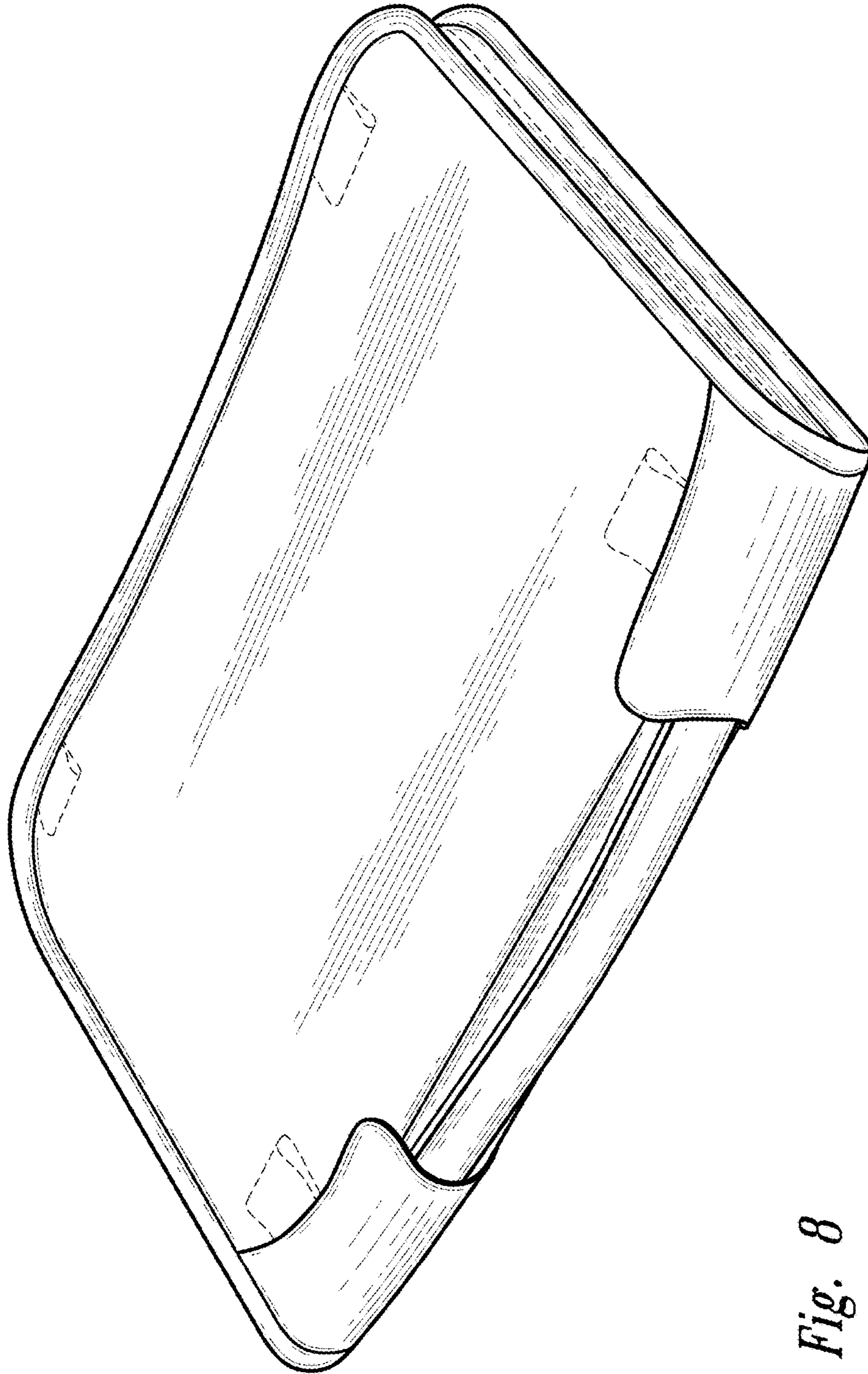

Fig. 8

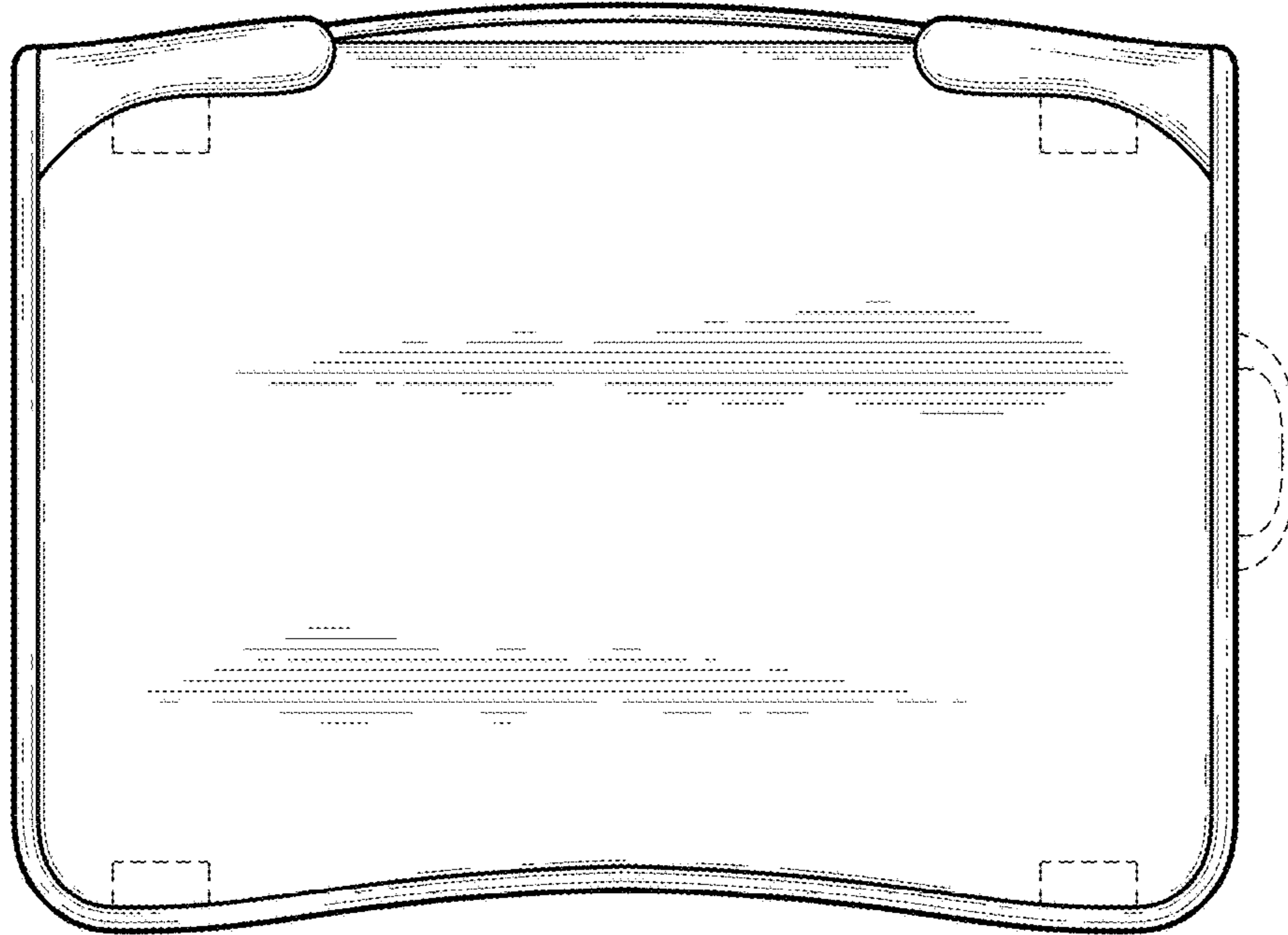

Fig. 9

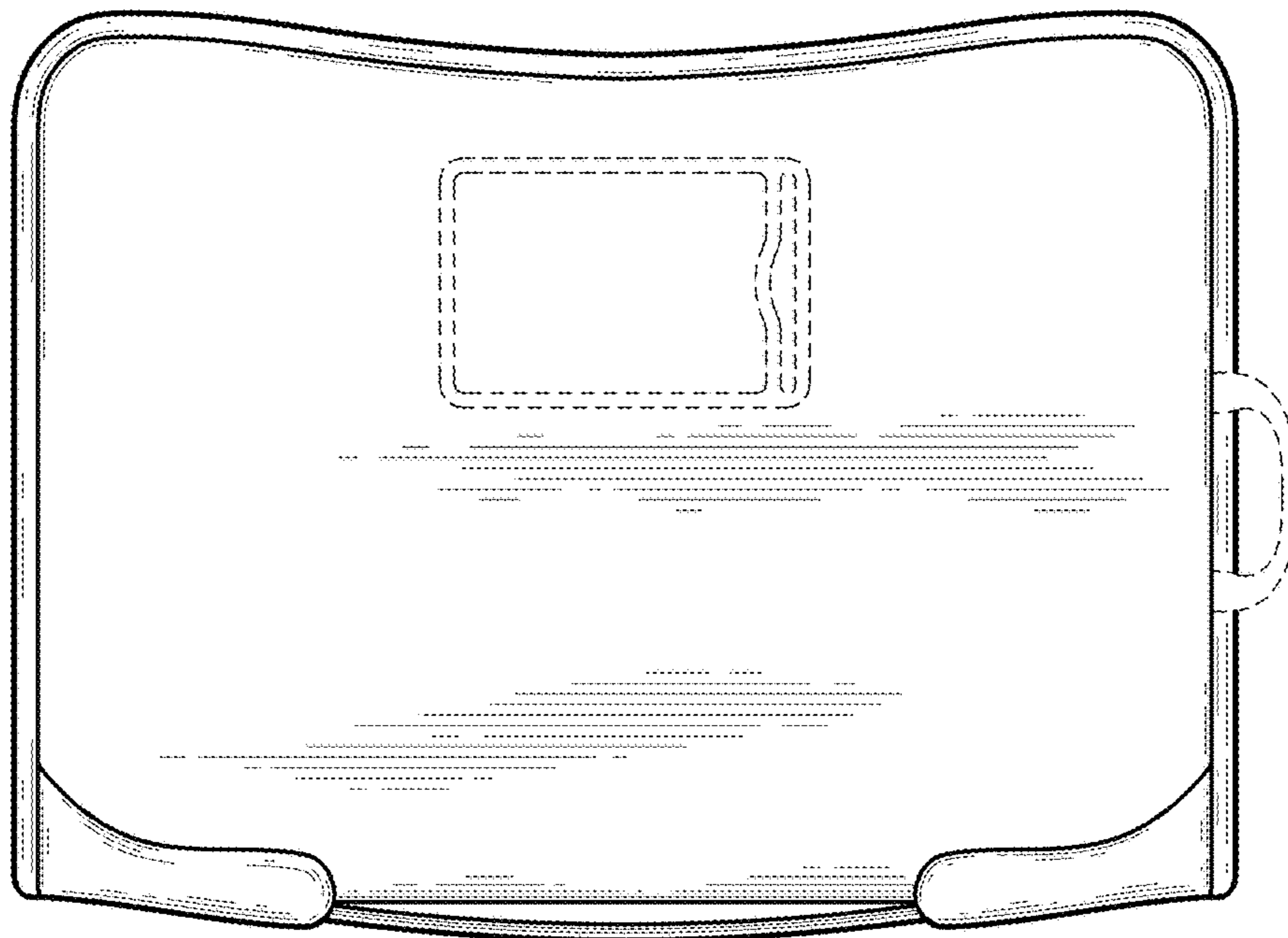

Fig. 10

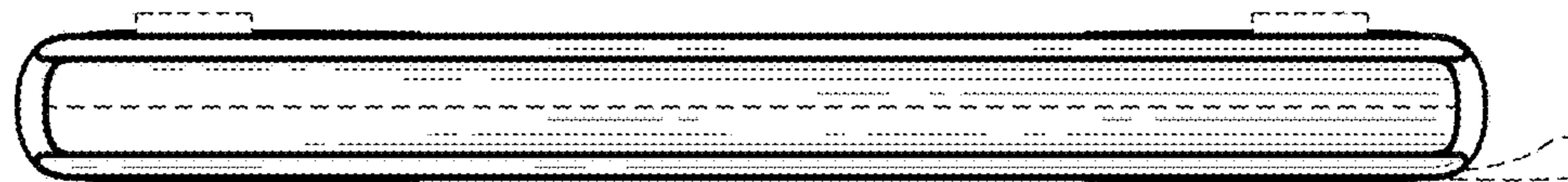

Fig. 11

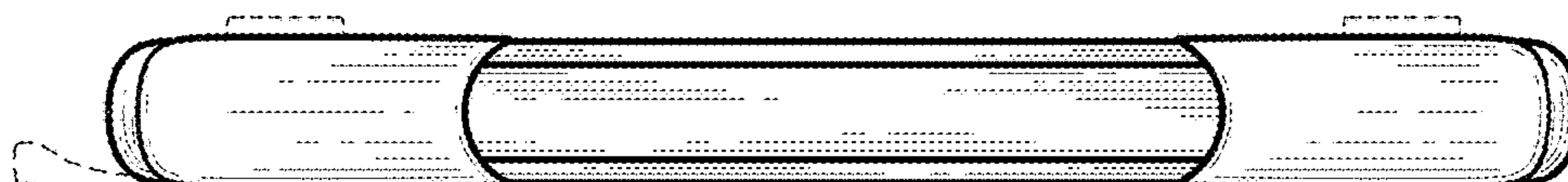

Fig. 12

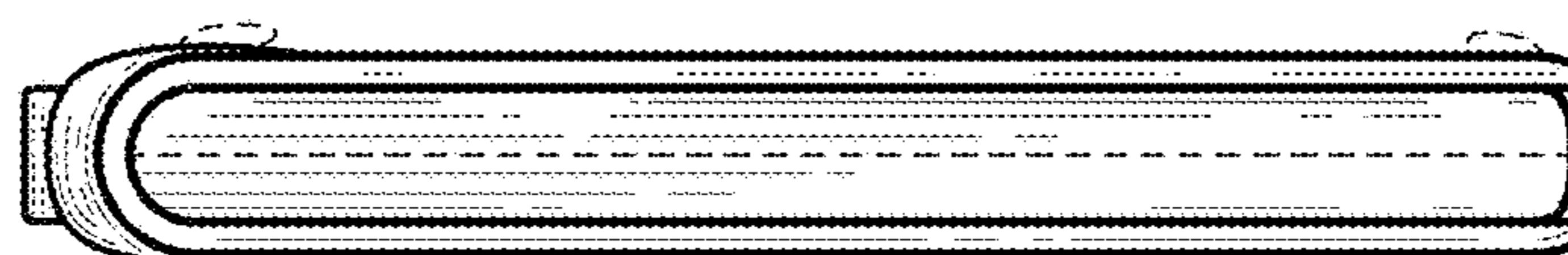

Fig. 13

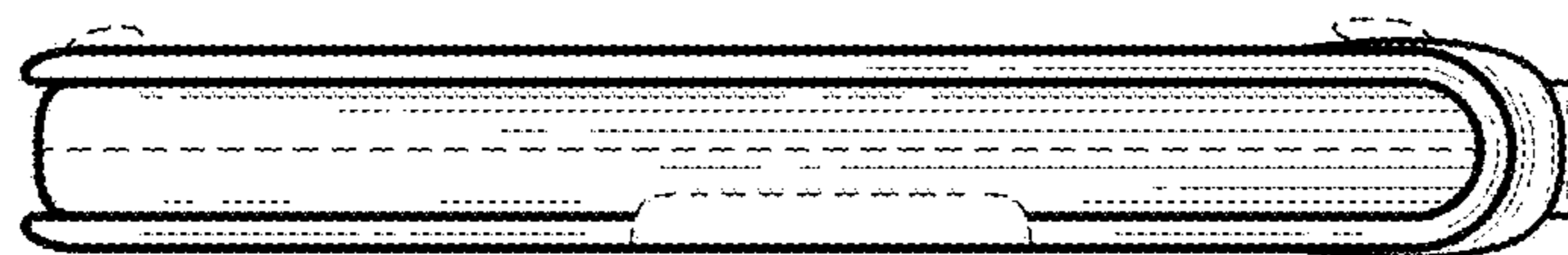

Fig. 14