



US00D837781S

(12) **United States Design Patent** (10) **Patent No.:** **US D837,781 S**
Ingram et al. (45) **Date of Patent:** **** Jan. 8, 2019**

(54) **CELLPHONE CASE WITH ROTATING COMFORT GRIP**

8,485,404 B2 * 7/2013 Monaco A45C 11/00
206/320

(Continued)

(71) Applicant: **Jason Ingram**, Paducah, KY (US)

Primary Examiner — Darlington Ly

(72) Inventors: **Jason Ingram**, Boaz, KY (US);
Matthew Seabaugh, Symsonia, KY (US)

(74) *Attorney, Agent, or Firm* — Marcum Tennyson PLLC

(**) Term: **15 Years**

(57) **CLAIM**

(21) Appl. No.: **35/001,305**

The ornamental design for a cellphone case with rotating comfort grip, as shown and described.

(22) Filed: **Dec. 14, 2016**

DESCRIPTION

(80) **Hague Agreement Data**

Int. Filing Date: **Dec. 14, 2016**

Int. Reg. No.: **DM/095419**

Int. Reg. Date: **Dec. 14, 2016**

Int. Reg. Pub. Date: **Apr. 7, 2017**

(51) **LOC (11) Cl.** **14-03**

(52) **U.S. Cl.**
USPC **D14/250**

(58) **Field of Classification Search**
USPC D3/201, 218, 247, 269, 273, 301, 303;
D13/103, 107, 108, 119;
D14/203.3–203.7, 217, 238.1, 247, 248,
D14/250, 251–253, 269, 273, 301, 303,
D14/440
CPC H04B 1/3888; H04M 1/0283; H04M
1/0202; A45C 1/06; A45C 2011/002;
A45C 23/02; A45C 11/00; A45F
2005/028; A45F 2200/0525; A45F
2200/0516

See application file for complete search history.

(56) **References Cited**

U.S. PATENT DOCUMENTS

D644,428 S * 9/2011 Feng D3/218
D651,205 S * 12/2011 Soekoro D14/250
D673,551 S * 1/2013 Chang D14/250
D674,380 S * 1/2013 Soekoro D14/250

(Continued)

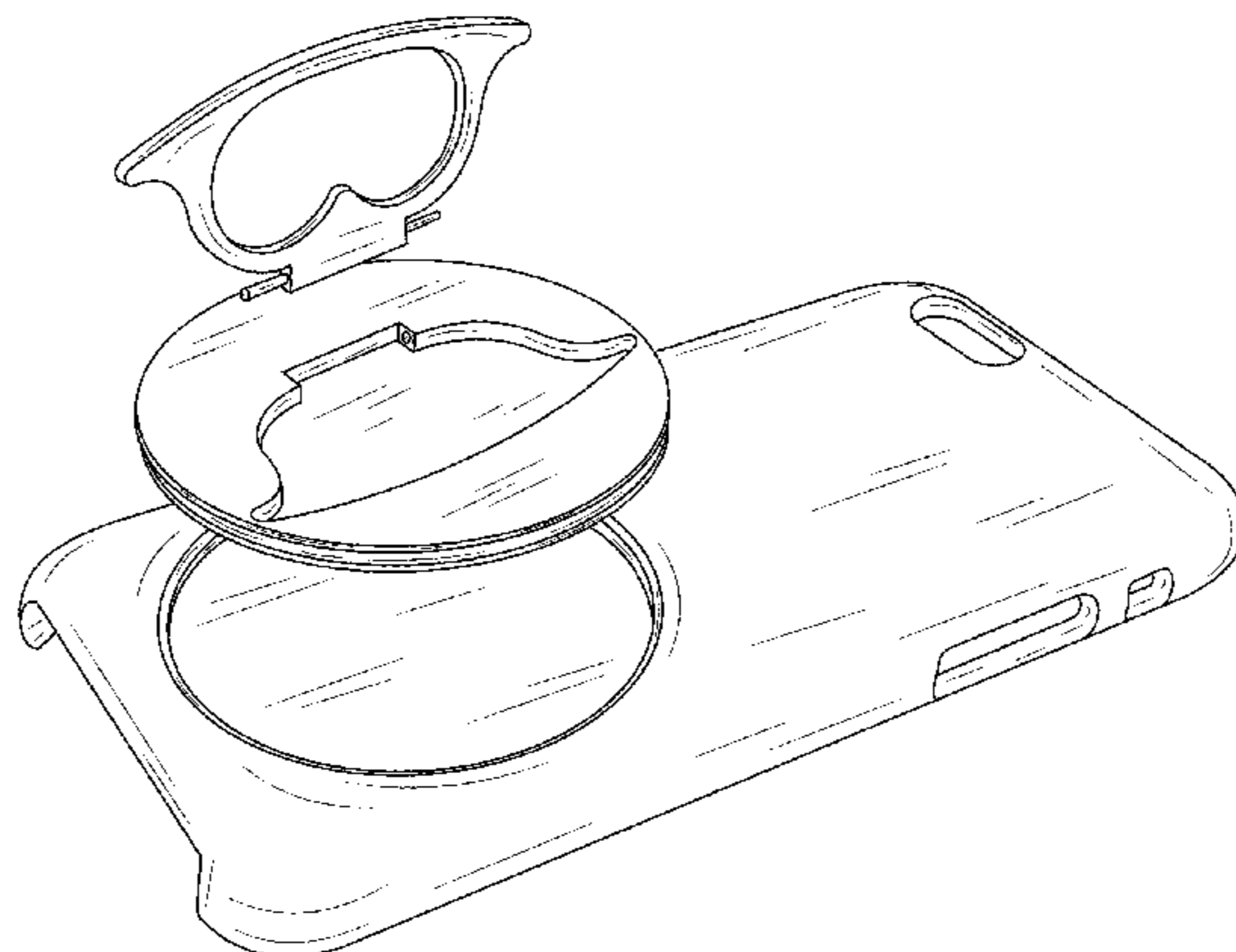

The broken line showing of a hand in reproduction 1.16 is provided for the purpose of illustrating environmental structure and forms no part of the claimed design.

1 Claim, 16 Drawing Sheets

(56)

References Cited

U.S. PATENT DOCUMENTS

8,783,531	B2 *	7/2014	Kroupa	B65H 75/4431
				224/162
D711,866	S *	8/2014	Kawata	D14/250
8,873,250	B2 *	10/2014	Kroupa	B65H 75/4434
				242/400
D718,760	S *	12/2014	Davis	D14/253
D721,072	S *	1/2015	Laffon de Mazieres	D14/250
D724,310	S *	3/2015	Dong	D3/218
D729,787	S *	5/2015	Soekoro	D14/250
D735,706	S *	8/2015	Stevinson	D14/250
9,369,167	B2 *	6/2016	Choi	H04M 1/0202
9,407,048	B2 *	8/2016	George	H01R 13/72
D765,643	S *	9/2016	Witter	D14/250
D765,644	S *	9/2016	Witter	D14/250
D771,611	S *	11/2016	Chang	D14/250
D773,445	S *	12/2016	Witter	D14/250
D777,157	S *	1/2017	Kim	D14/250
D777,160	S *	1/2017	Kim	D14/250
D780,742	S *	3/2017	Guerdrum	D14/250
9,674,324	B1 *	6/2017	Duphiney	H04M 1/0281
9,762,013	B2 *	9/2017	George	H01R 35/025
9,788,640	B2 *	10/2017	Kroupa	A45F 5/004
D808,377	S *	1/2018	Witter	D14/250
2013/0344925	A1	12/2013	Lu	

* cited by examiner

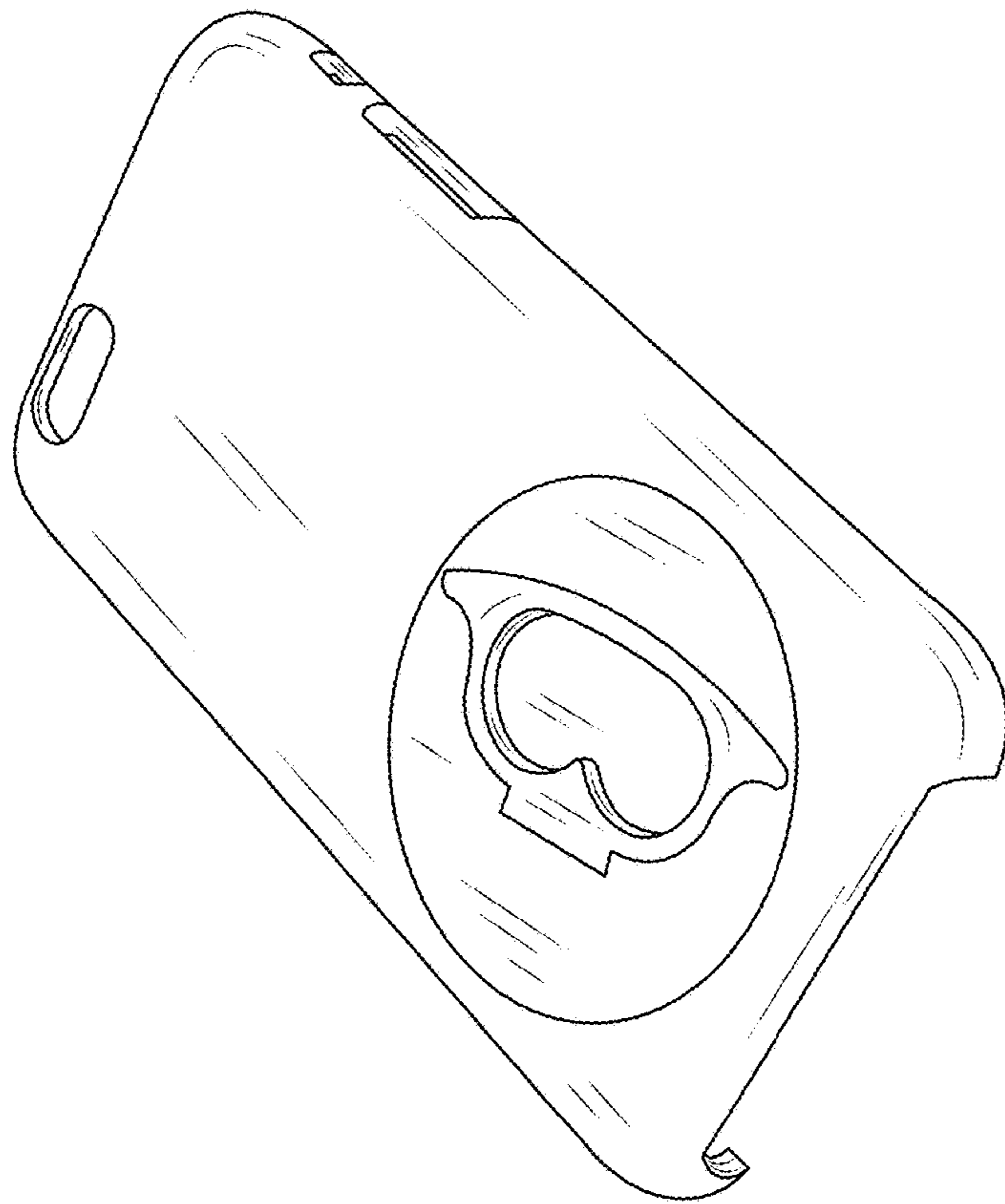

FIG. 1.1

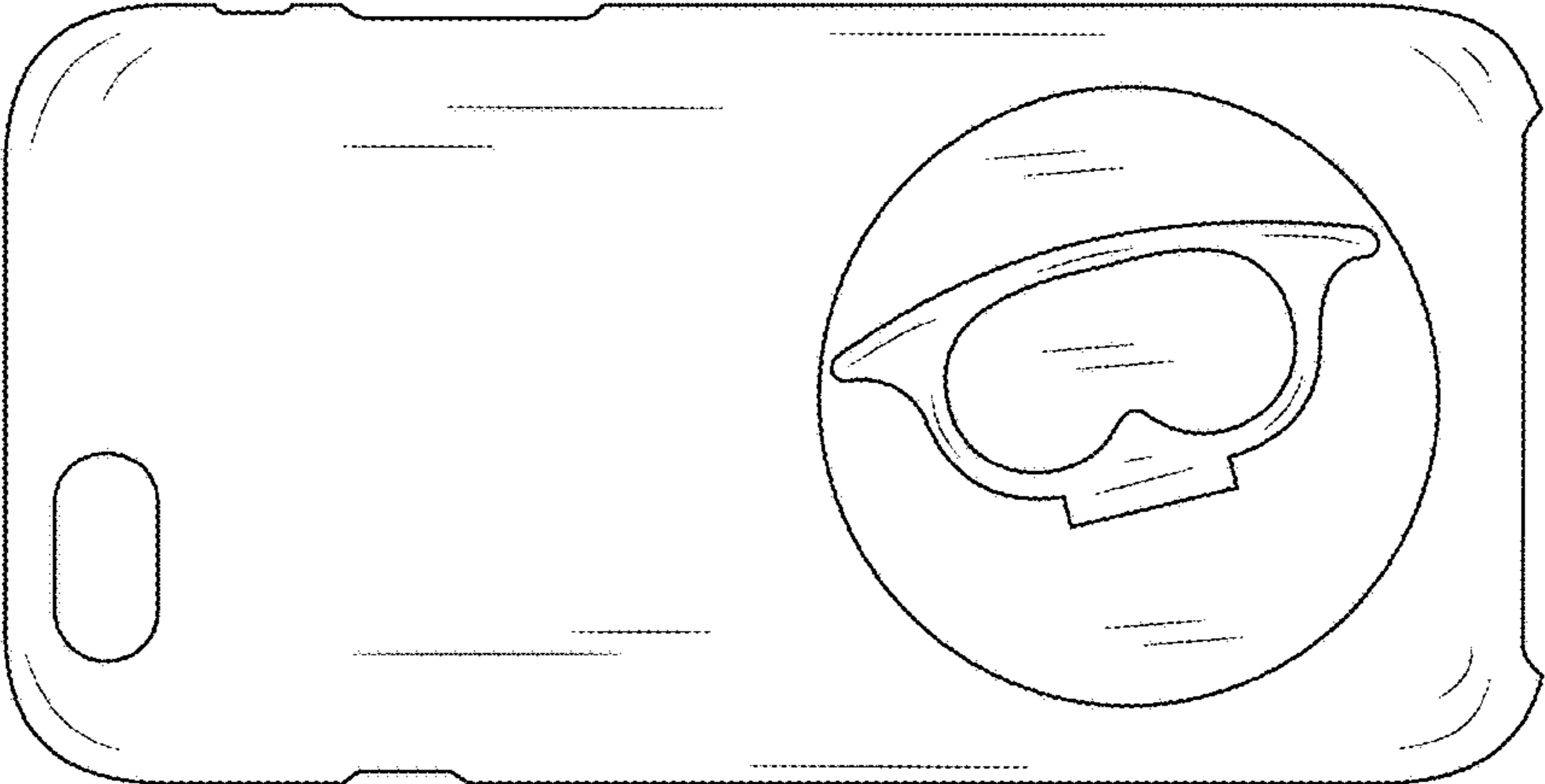

FIG. 1.2

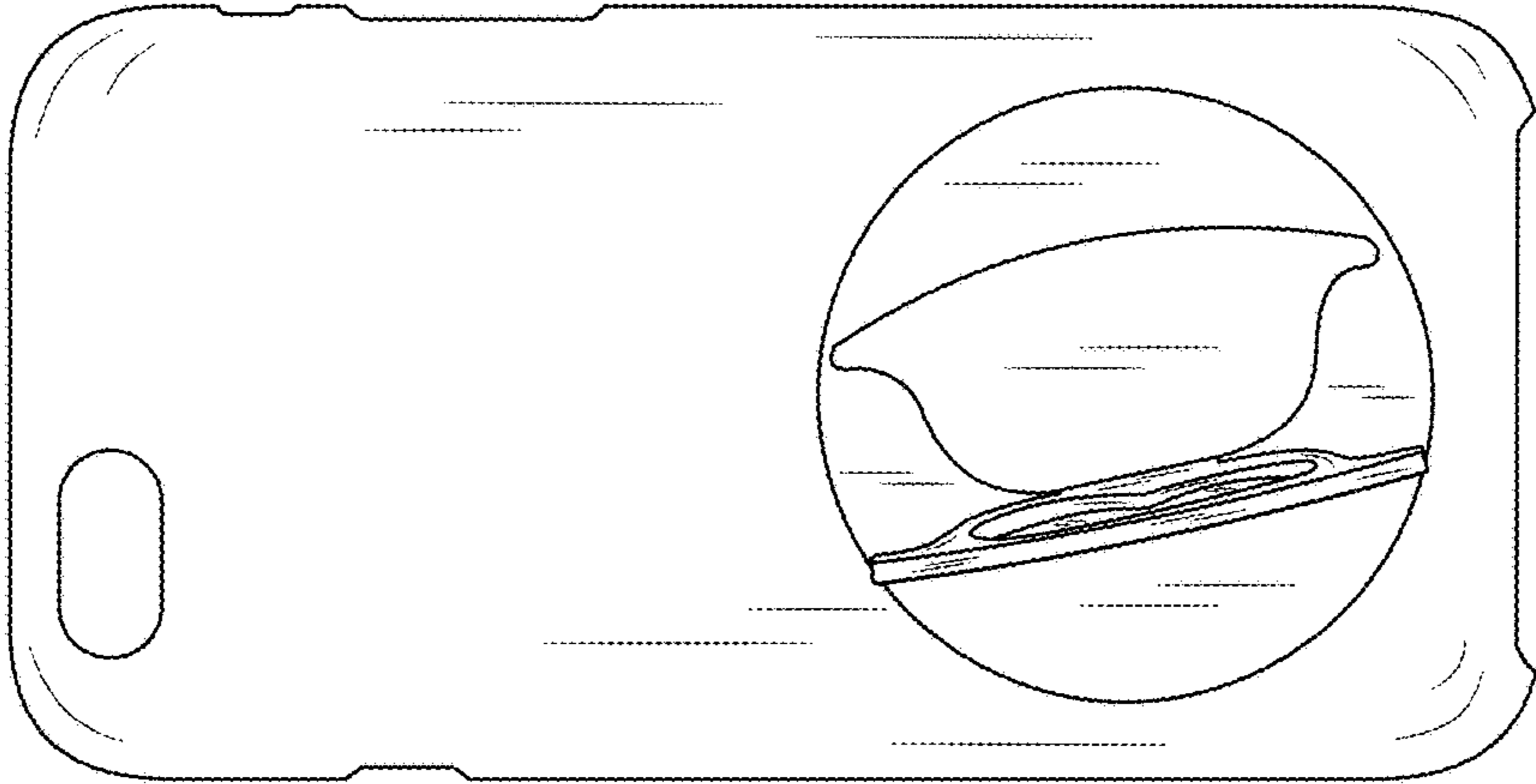

FIG. 1.3

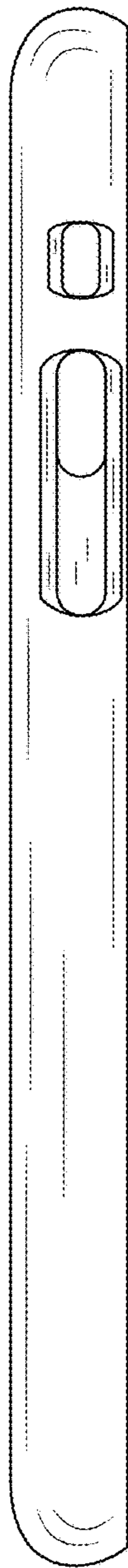

FIG. 1.4

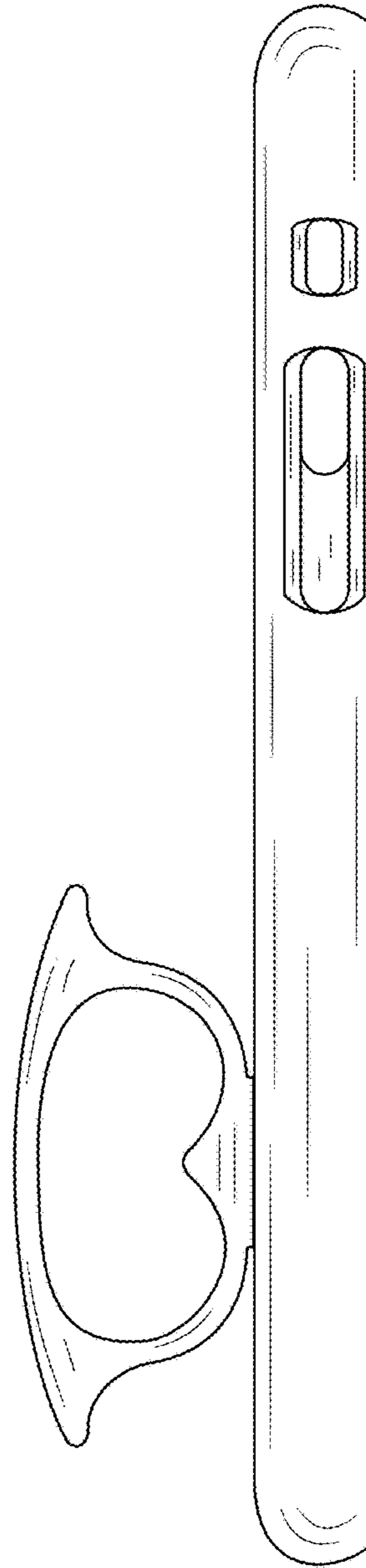

FIG. 1.5

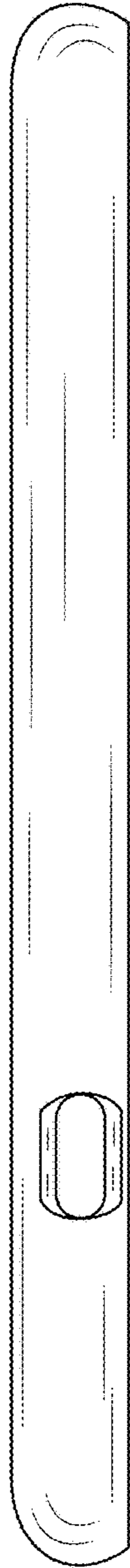

FIG. 1.6

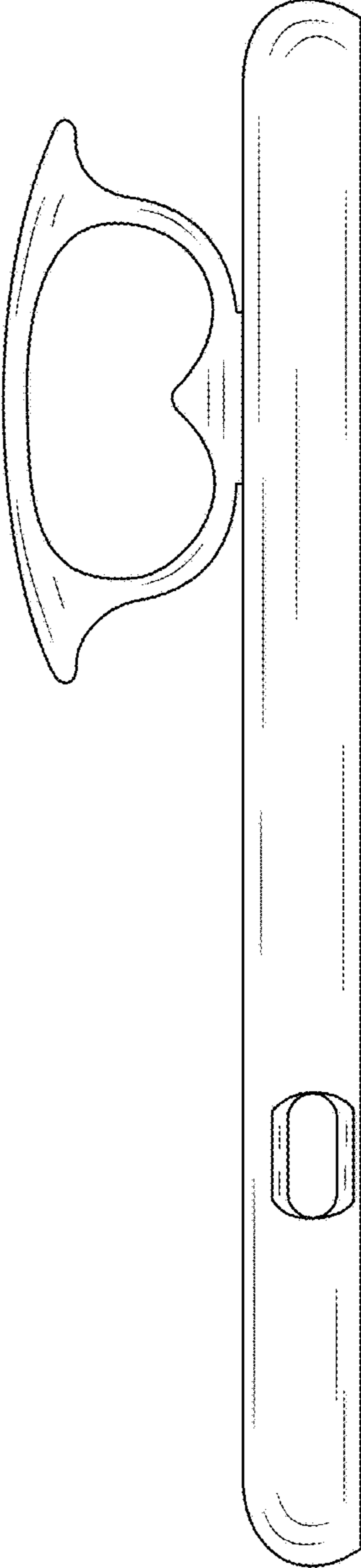

FIG. 1.7



FIG. 1.8

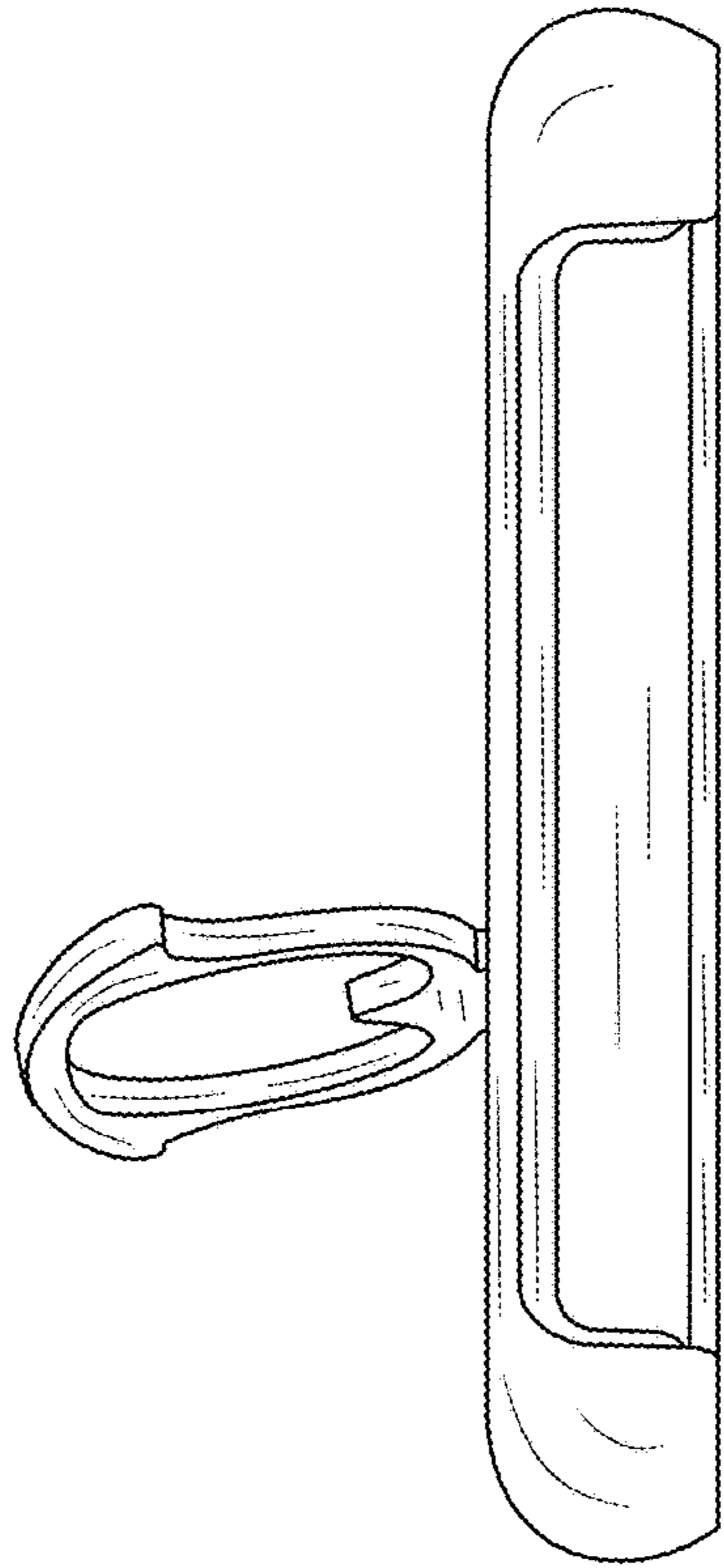

FIG. 1.9



FIG. 1.10

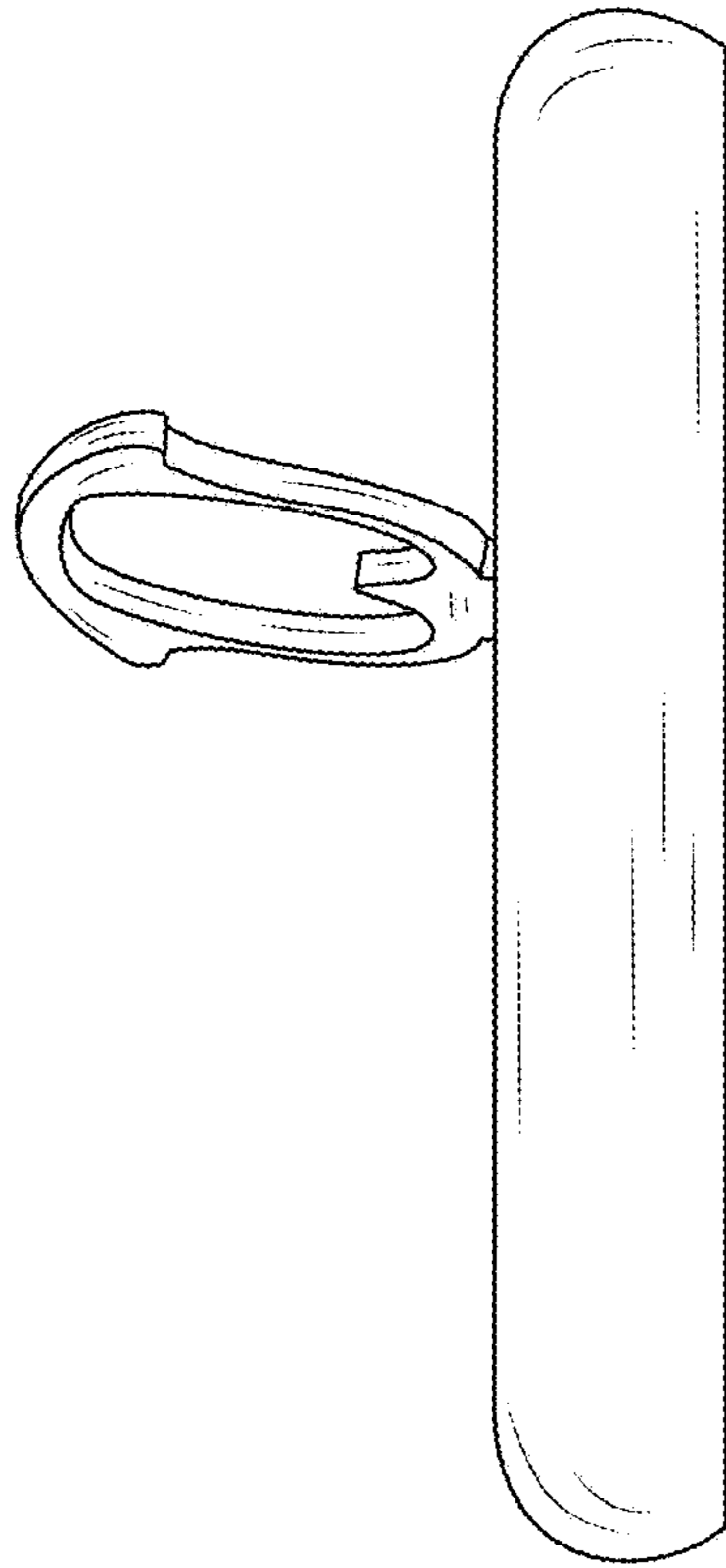

FIG. 1.11

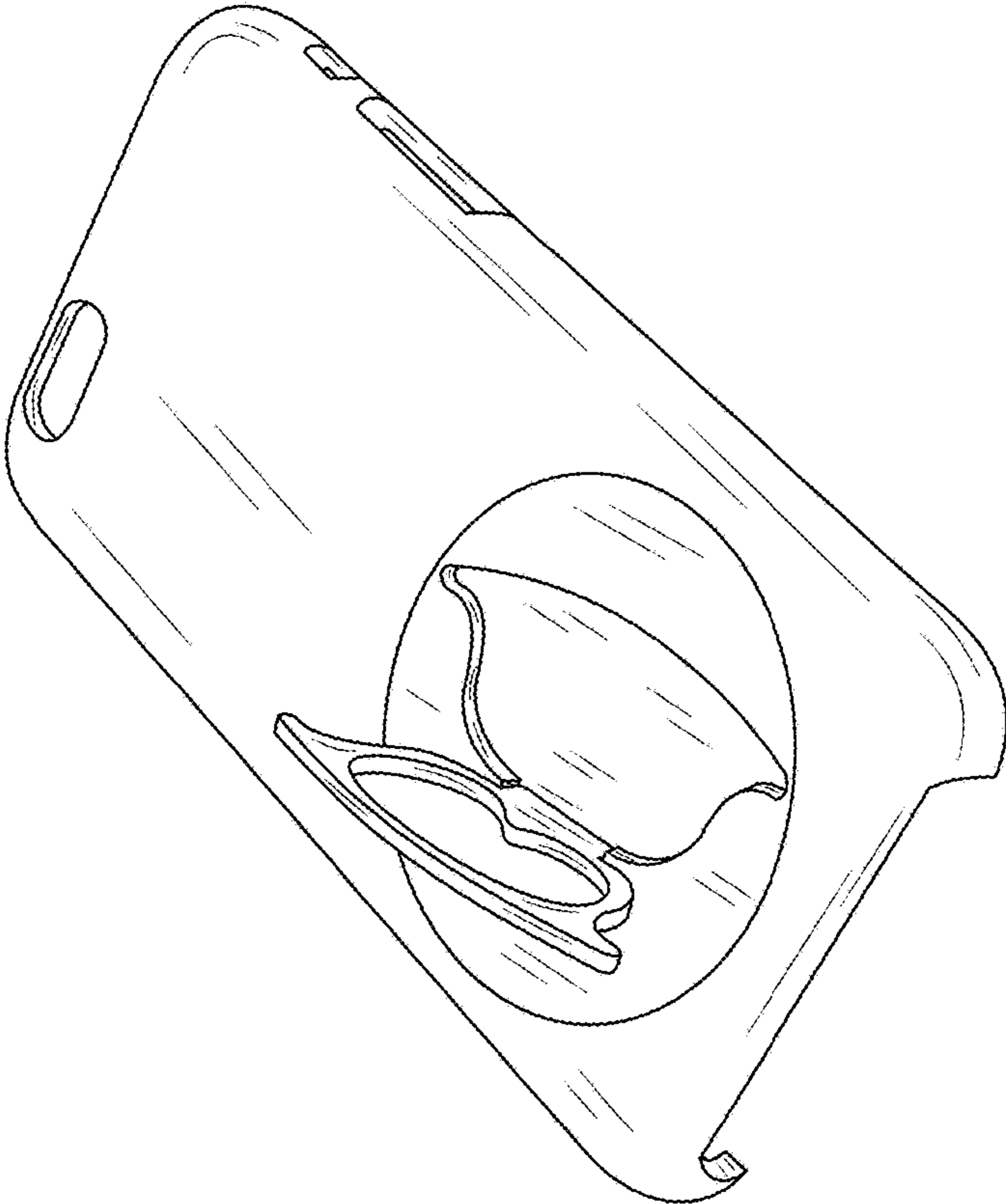

FIG. 1.12

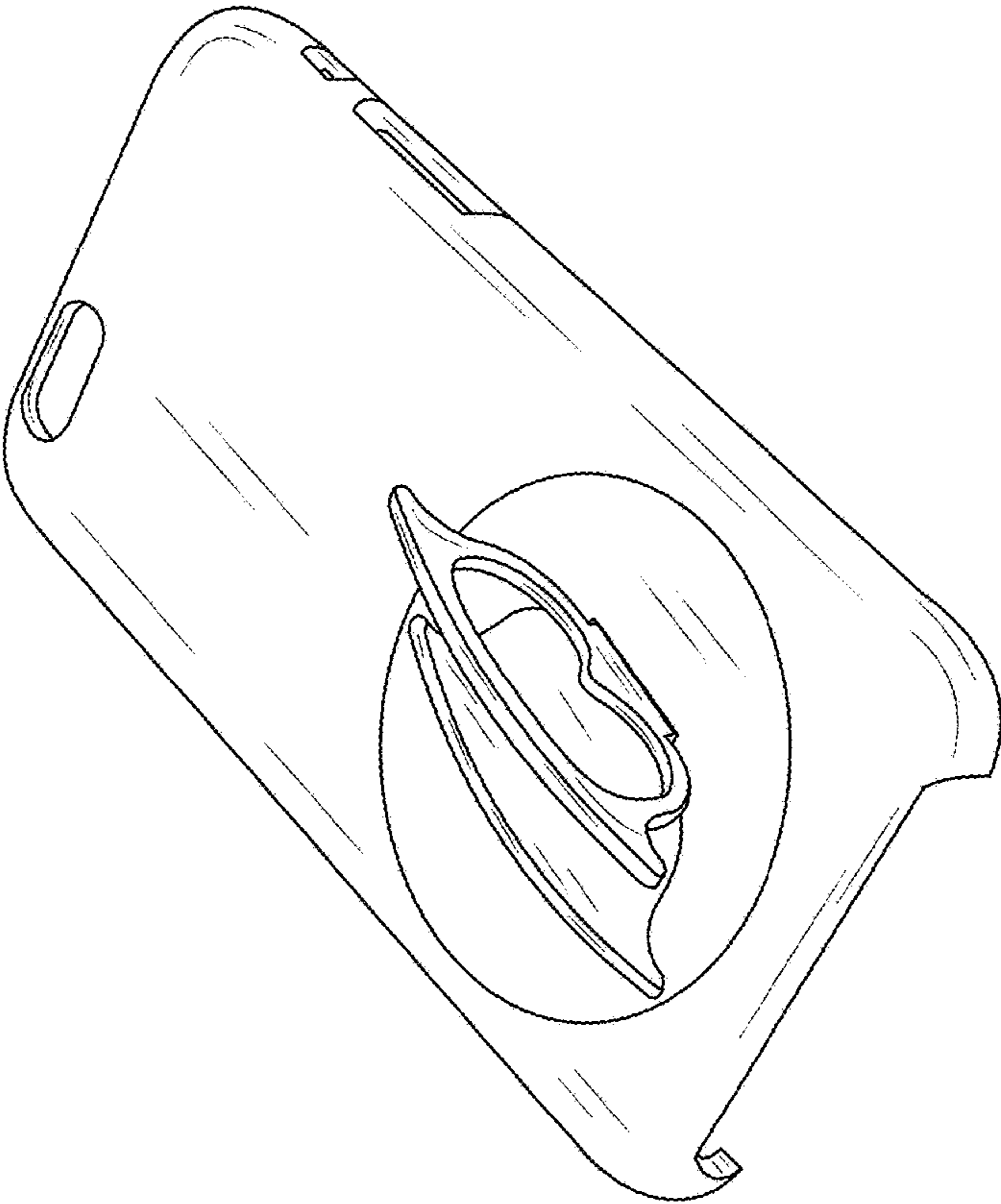

FIG. 1.13

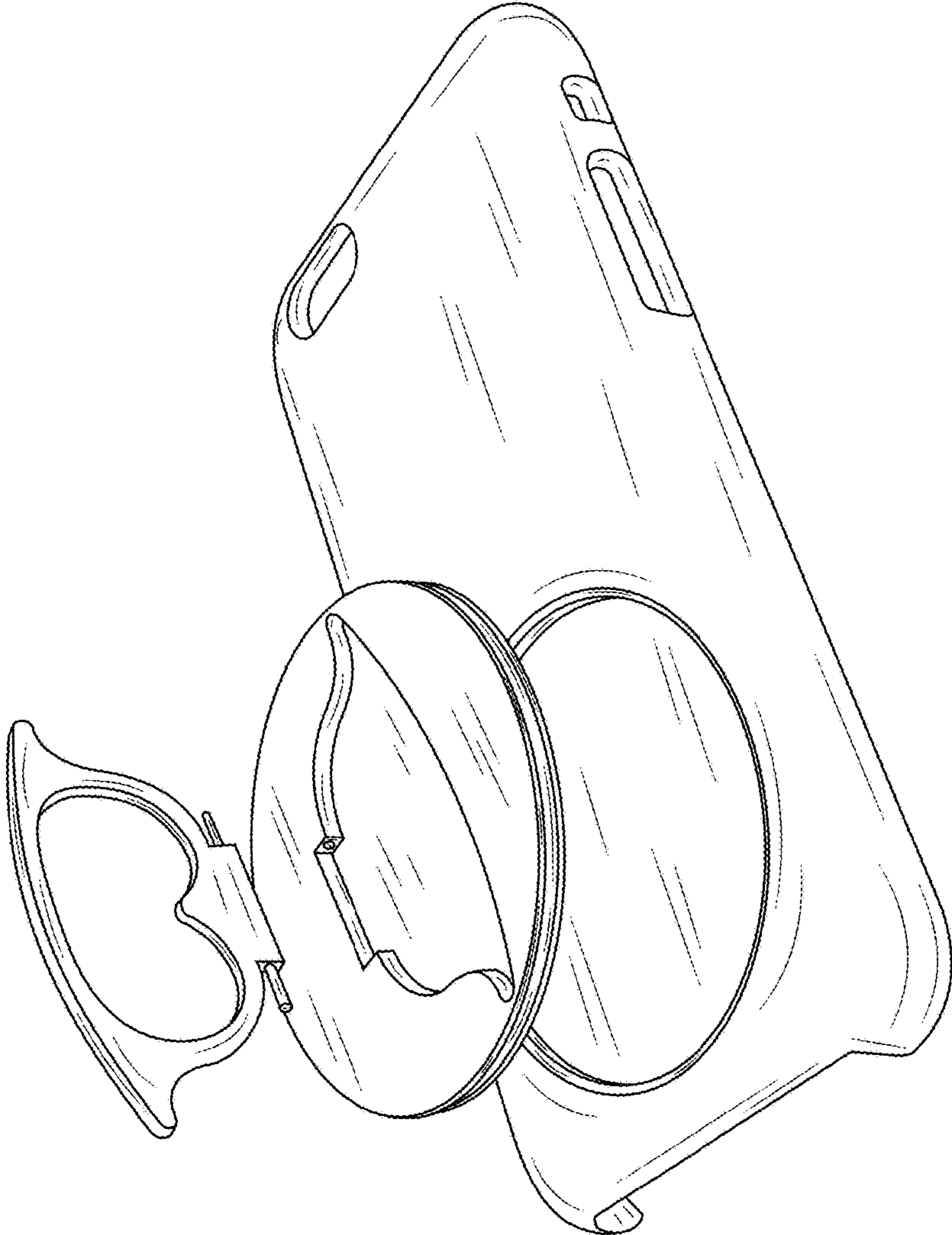

FIG. 1.14

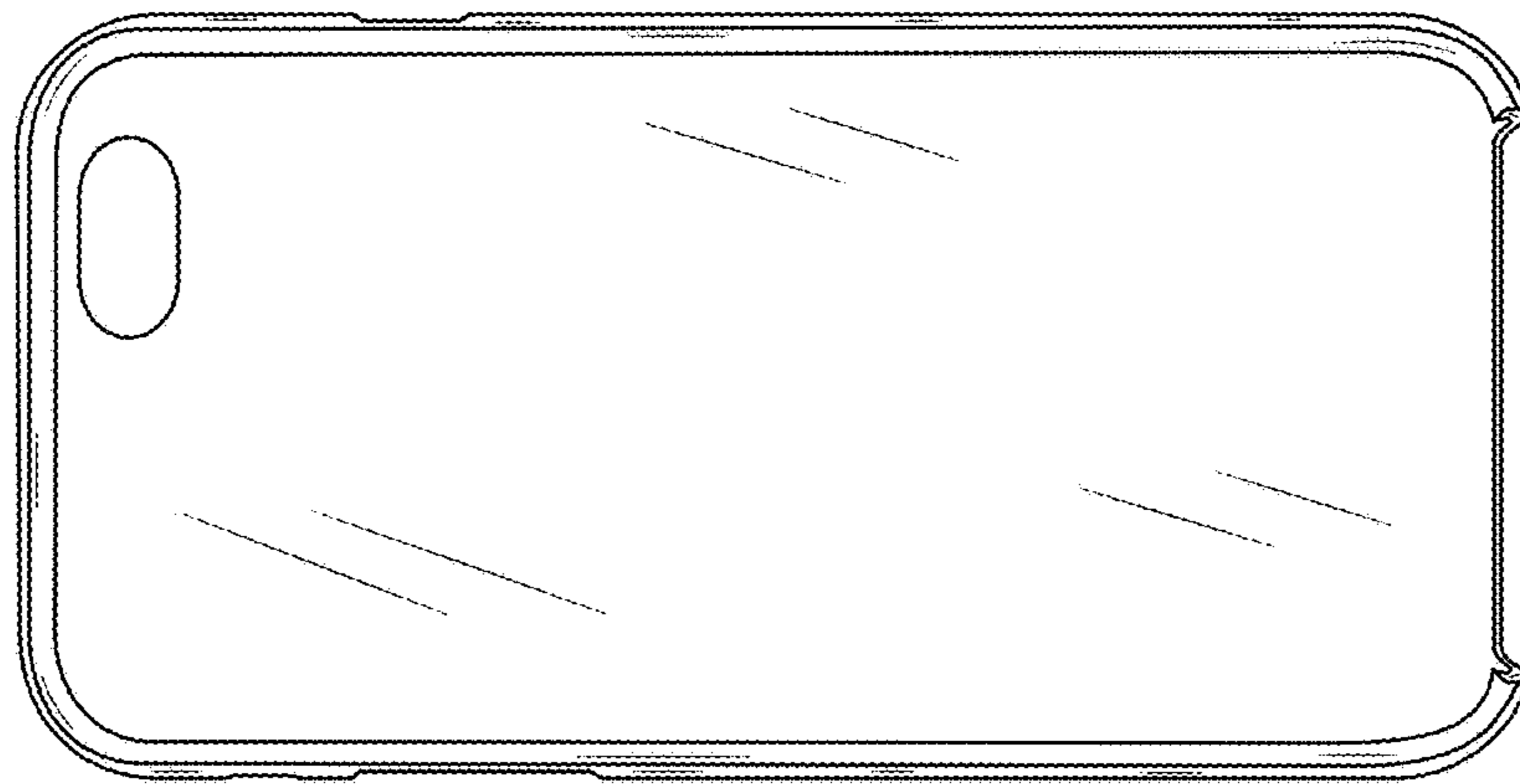

FIG. 1.15

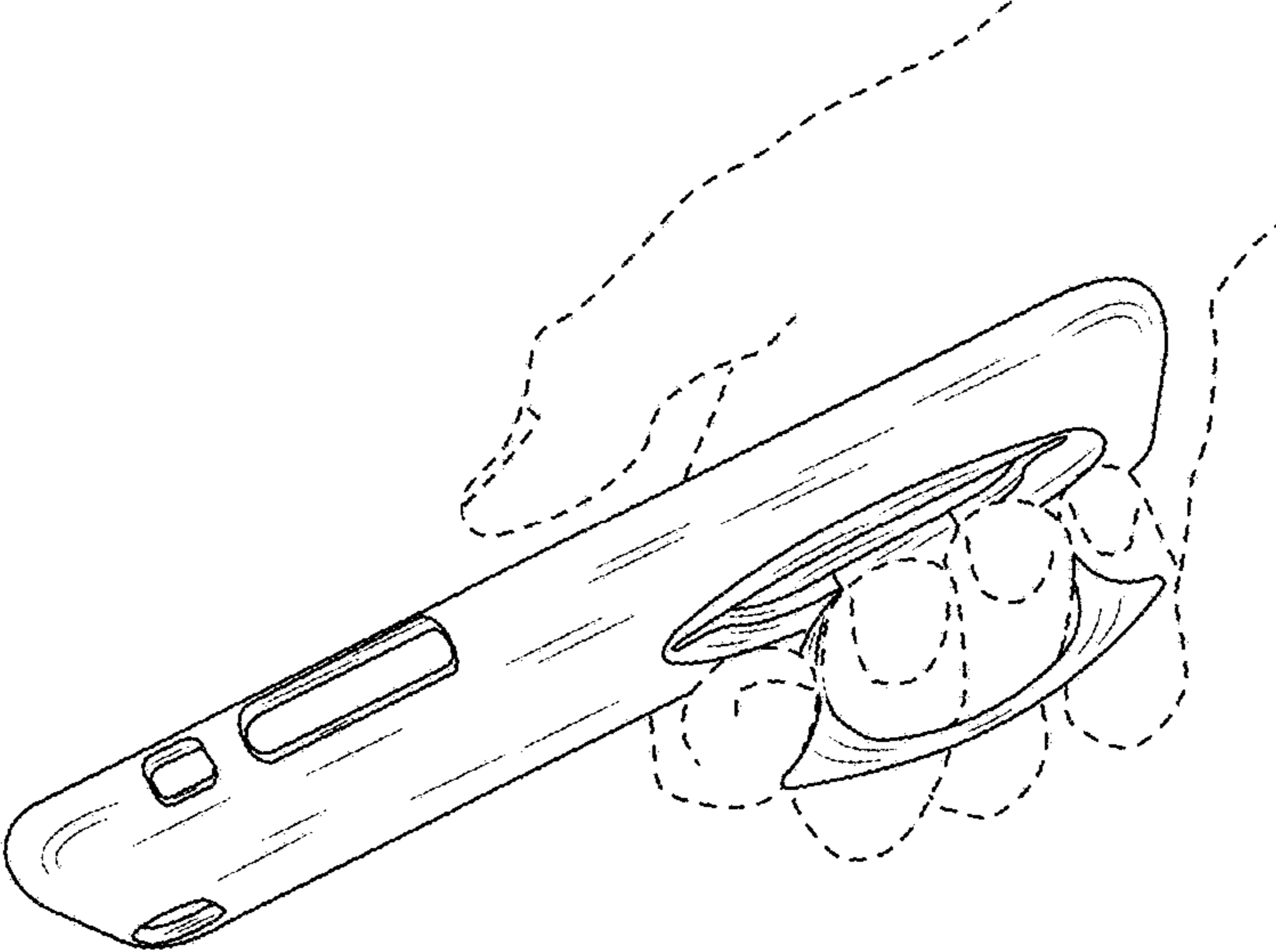

FIG. 1.16