



US00D837654S

(12) **United States Design Patent** (10) **Patent No.:** **US D837,654 S**
Chen et al. (45) **Date of Patent:** **** Jan. 8, 2019**

(54) **CONTAINER**

(71) Applicant: **Conopco, Inc.**, Englewood Cliffs, NJ (US)

(72) Inventors: **Weiqing Chen**, Shanghai (CN);
Thomas Peter Gilbert, Singapore (SG)

(73) Assignee: **Conopco, Inc.**, Englewood Cliffs, NJ (US)

(**) Term: **15 Years**

(21) Appl. No.: **29/598,538**

(22) Filed: **Mar. 27, 2017**

(30) **Foreign Application Priority Data**

Sep. 30, 2016 (EM) 003400282-0001

(51) **LOC (11) Cl.** **09-01**

(52) **U.S. Cl.**
USPC **D9/529**; D9/454; D9/504; D9/520

(58) **Field of Classification Search**
USPC D9/434-435, 444-445, 449, 454, 500,
D9/503-504, 516, 520, 529, 548-549,
D9/558, 715; D3/202, 203.2, 302;
D7/608, 629-630; D28/4, 8, 76, 91
CPC B65D 1/00; B65D 1/02; B65D 1/0223;
B65D 23/00; B65D 81/00; B65D
2501/00; B65D 2501/0009

See application file for complete search history.

(56) **References Cited**

U.S. PATENT DOCUMENTS

D20,336 S * 11/1890 Whilldin D11/152
D114,460 S * 4/1939 Platt D9/504
D155,043 S 8/1949 Serra
D223,691 S 5/1972 Newman
D254,180 S * 2/1980 Morin D7/612
4,440,181 A 4/1984 Scherer
4,703,863 A 11/1987 Kohus

D372,194 S * 7/1996 Dallaire D9/520
D373,084 S 8/1996 Choi
D405,699 S * 2/1999 Chae D9/558
D446,456 S * 8/2001 Adachi D9/504
D474,341 S 5/2003 Cantone et al.
D505,074 S 5/2005 Bakic
D509,434 S * 9/2005 Haruta D9/504
D512,914 S * 12/2005 Moretti D9/454
D530,572 S * 10/2006 Daams D7/615
D536,614 S * 2/2007 Peterson D9/454
D574,710 S 8/2008 Gangrade
D619,456 S * 7/2010 Walters D9/444
D699,593 S * 2/2014 Boon D9/734
D716,427 S * 10/2014 Lim D23/364

(Continued)

OTHER PUBLICATIONS

Day Cream & Eye Cream Range, Herborist, pp. 1-1.
Regener-activ Contorno de Ojos, Ponds, pp. 1-1 Eye cream pack from Spain.

Primary Examiner — Dana Meyrow

(74) *Attorney, Agent, or Firm* — Gerard J. McGowan, Jr.

(57) **CLAIM**

The ornamental design for a container, as shown and described.

DESCRIPTION

FIG. 1 is a perspective view of a container showing our new design;
FIG. 2 is a front elevational view thereof,
FIG. 3 is a rear elevational view thereof,
FIG. 4 is a side elevational view thereof;
FIG. 5 is an elevational view of the other side thereof;
FIG. 8 is a top plan view thereof; and,
FIG. 7 is a bottom plan view thereof.
All broken lines are directed to environment and are for illustrative purposes only; the broken lines form no part of the claimed design.

1 Claim, 4 Drawing Sheets

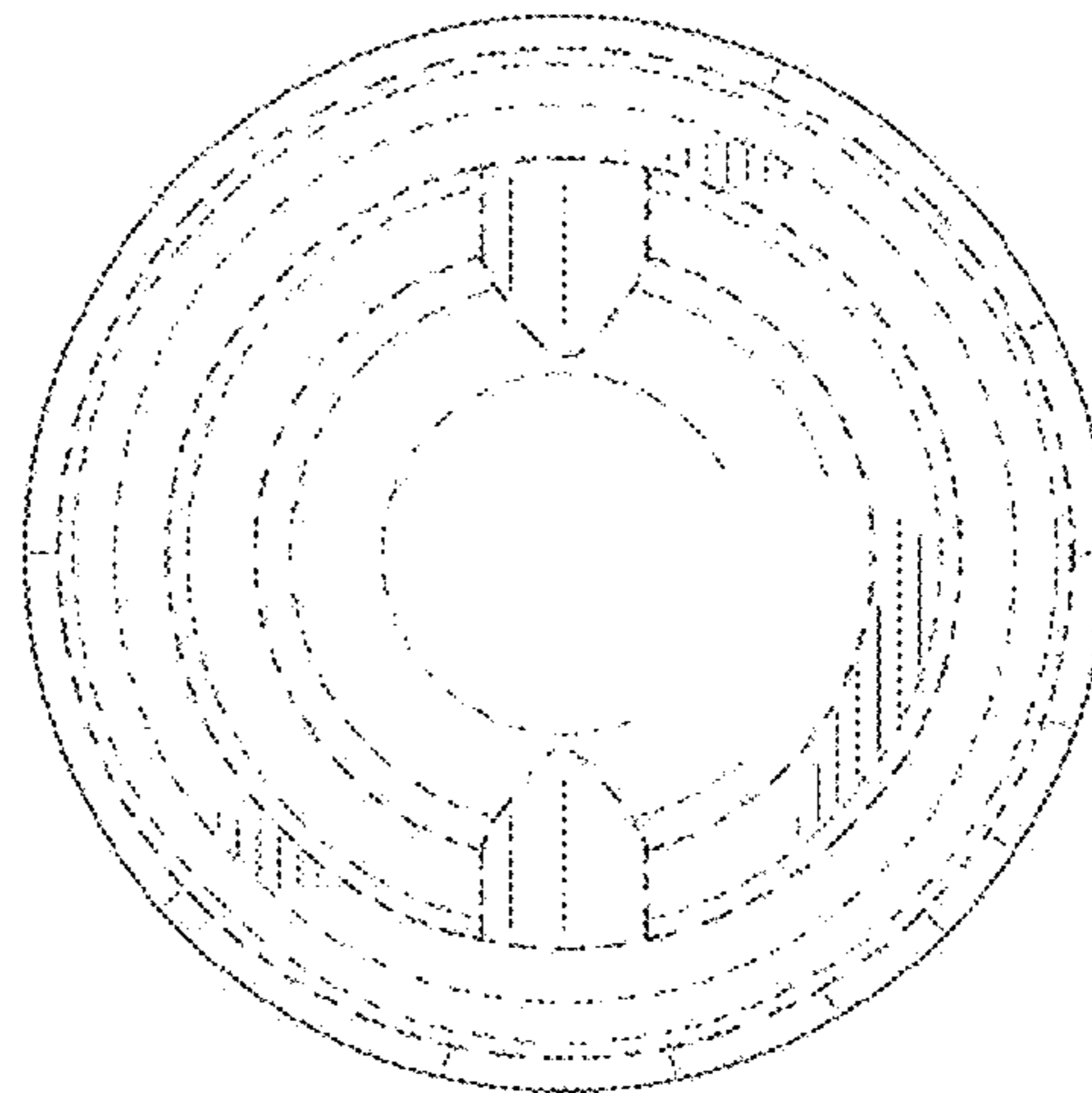
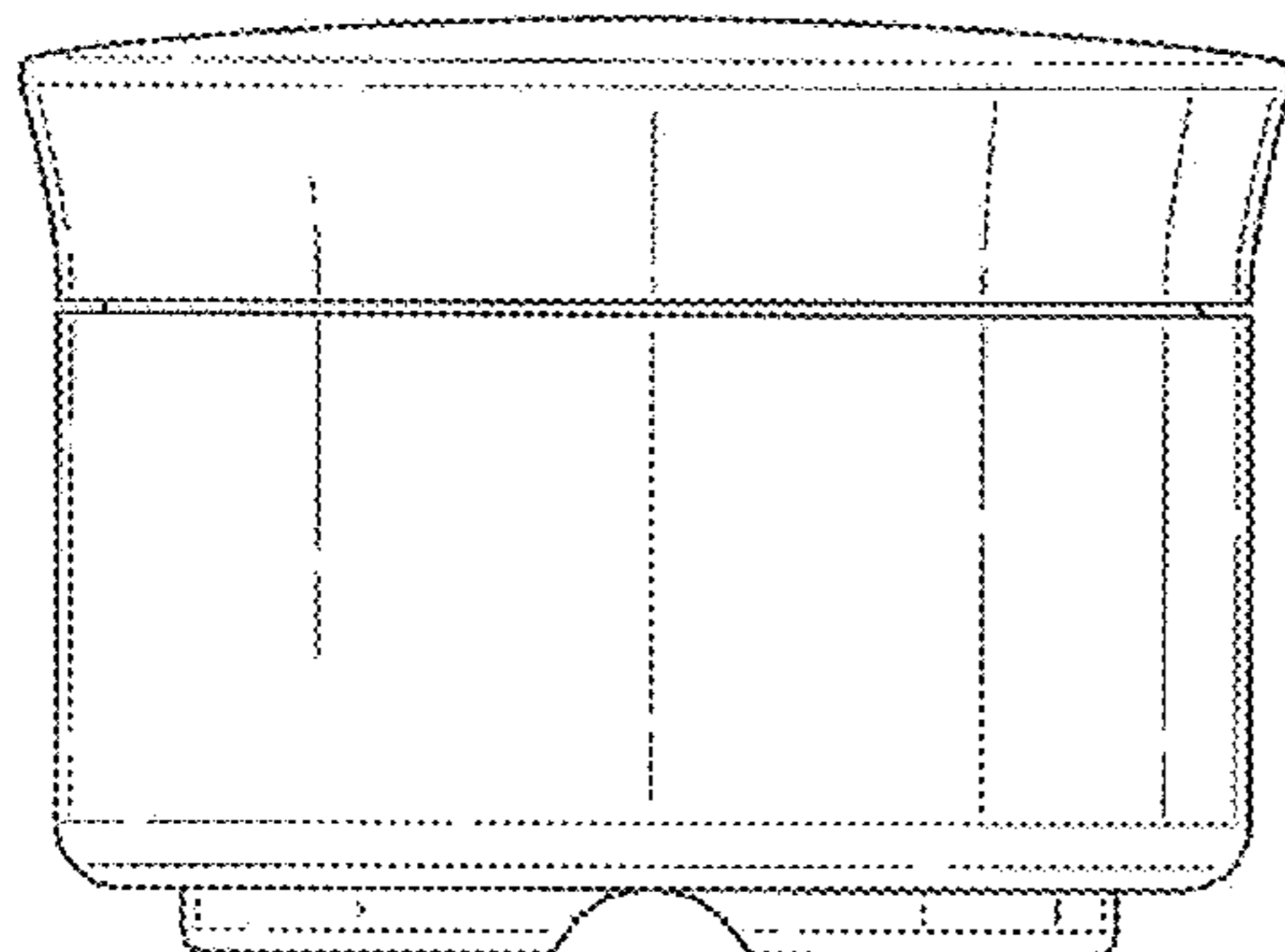

(56)

References Cited

U.S. PATENT DOCUMENTS

D739,738 S	9/2015	Kawai	
D816,505 S	5/2018	Percassi	
2011/0297704 A1*	12/2011	Esteve	A45D 34/00 222/390

* cited by examiner

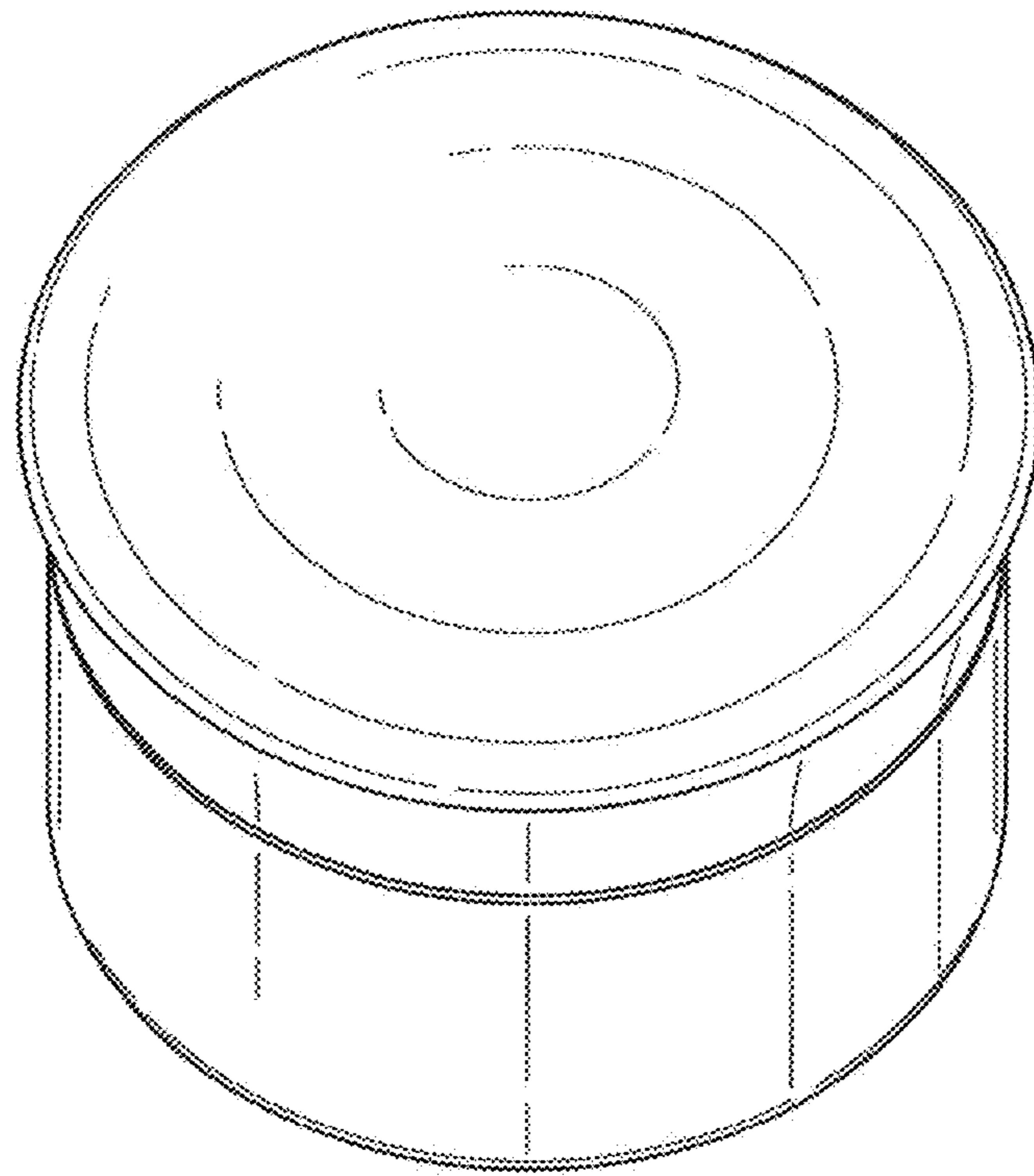

Fig. 1

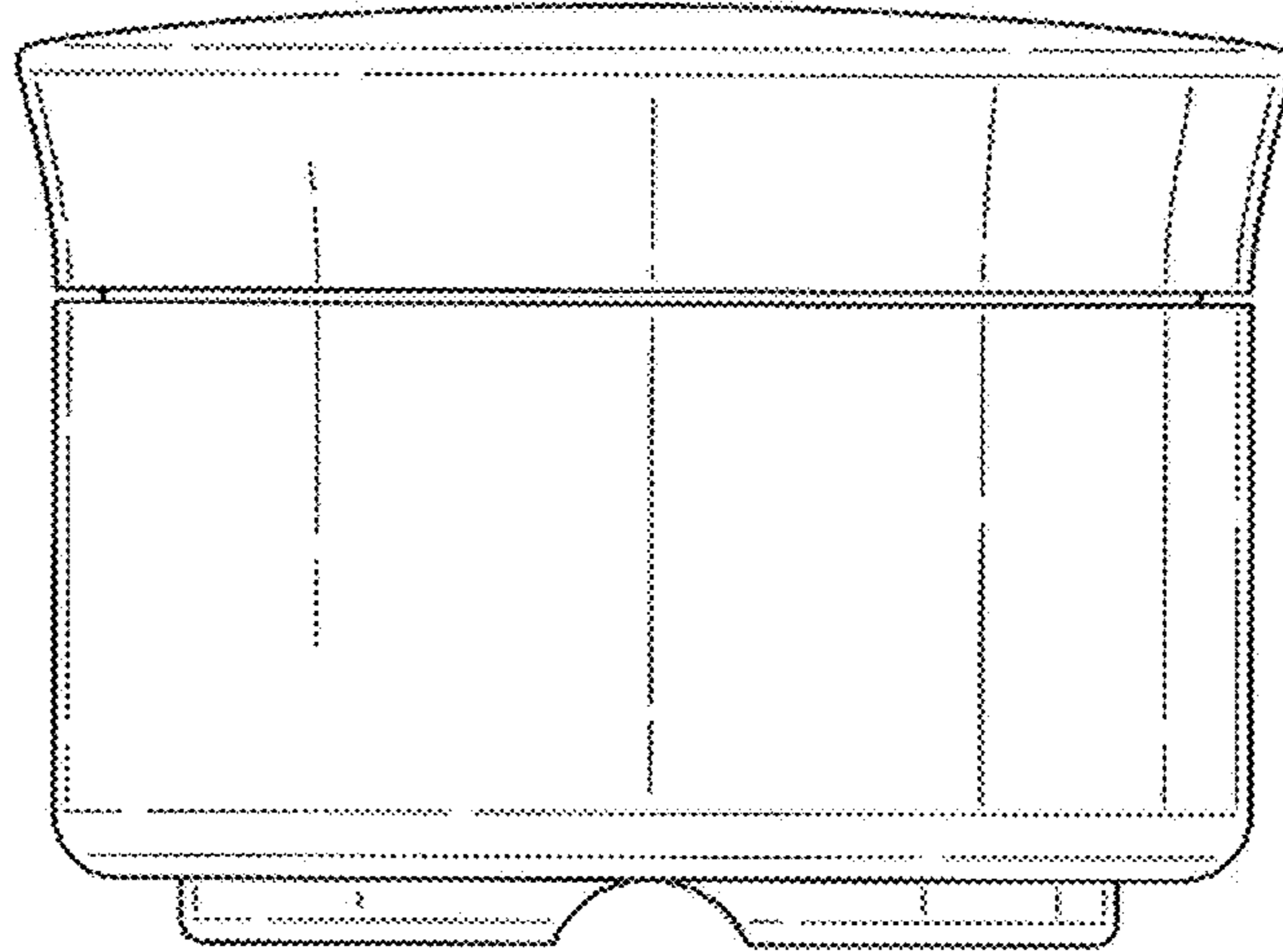

Fig. 2

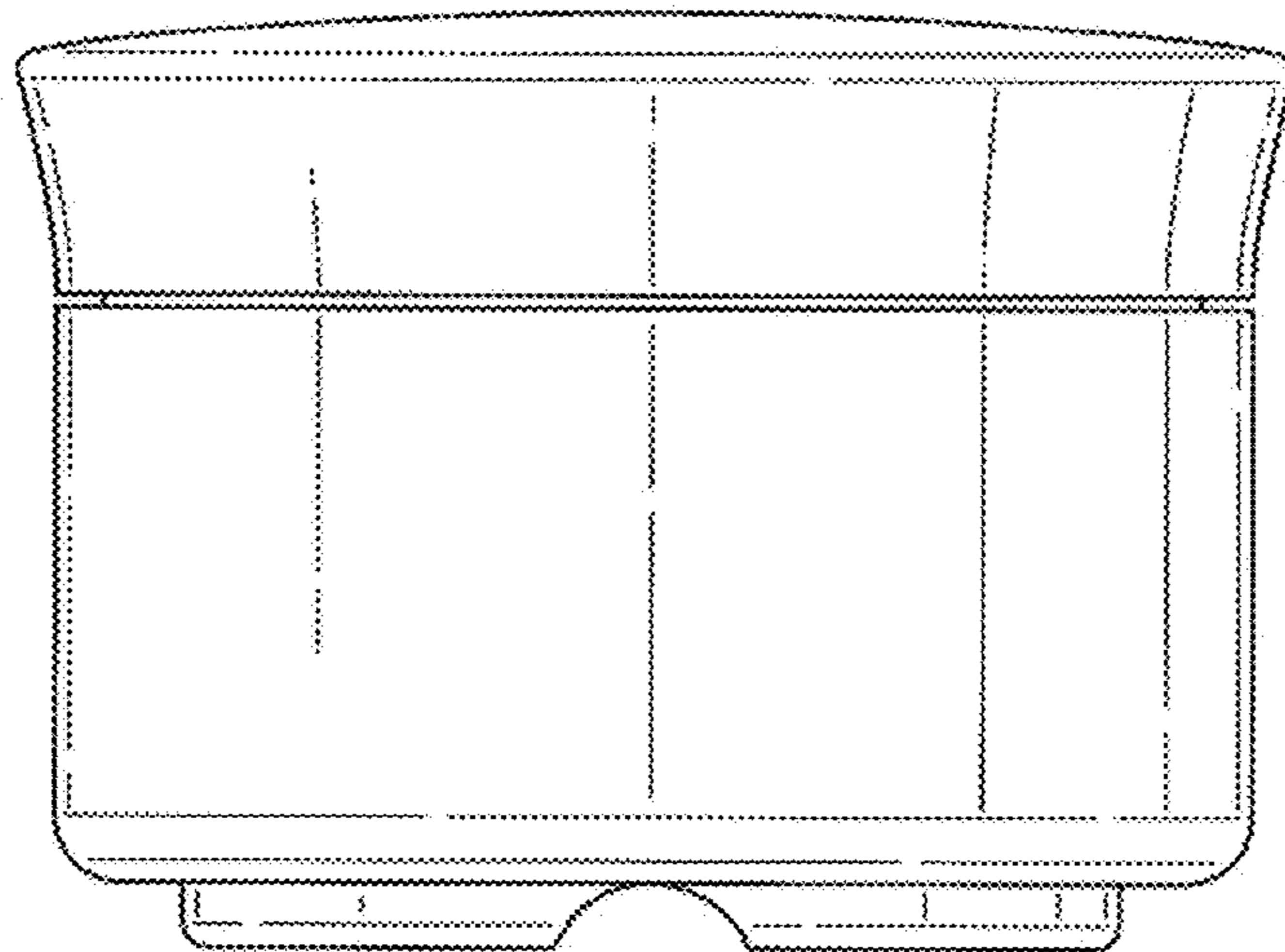

Fig. 3

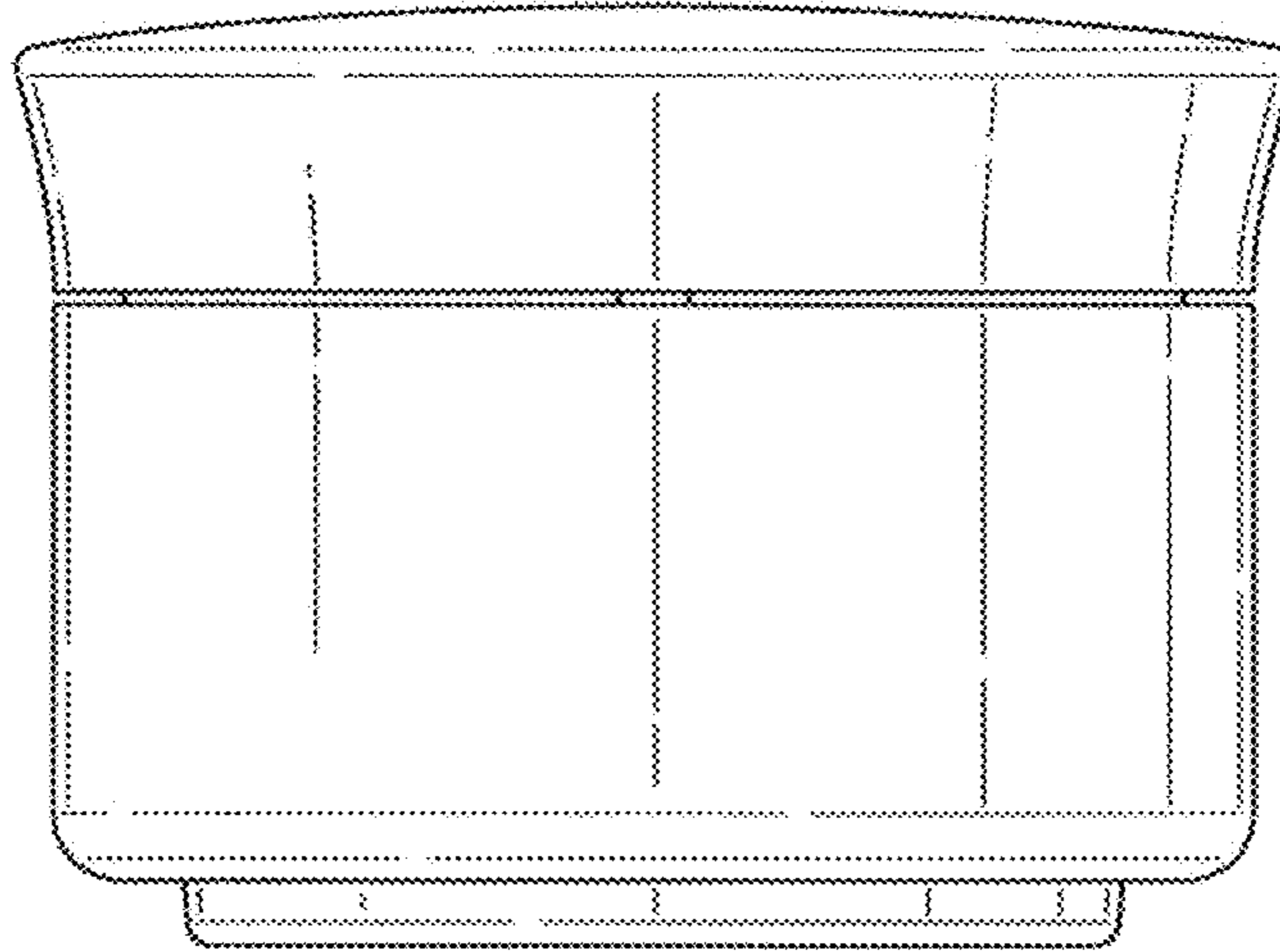

Fig. 4

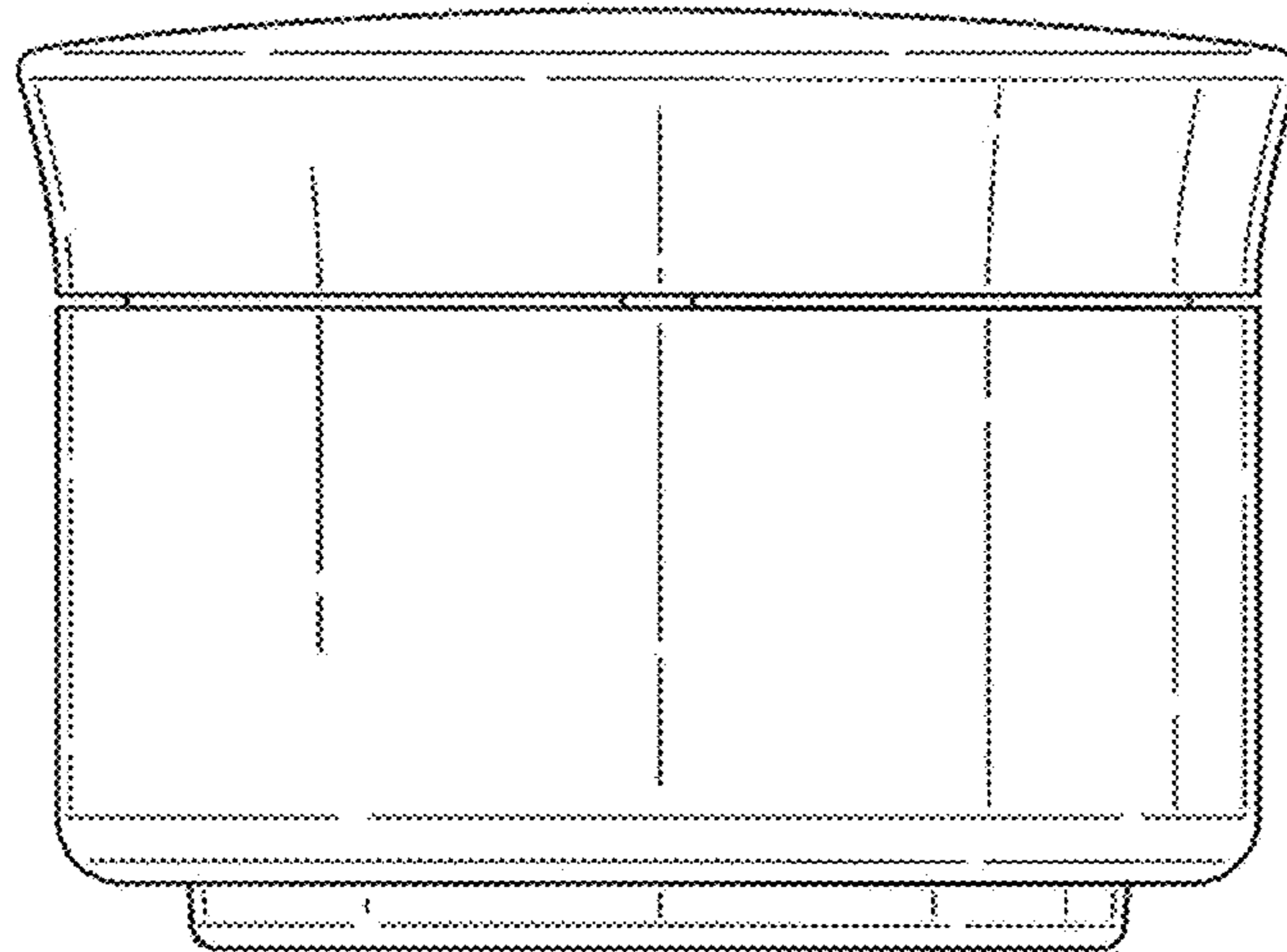

Fig. 5

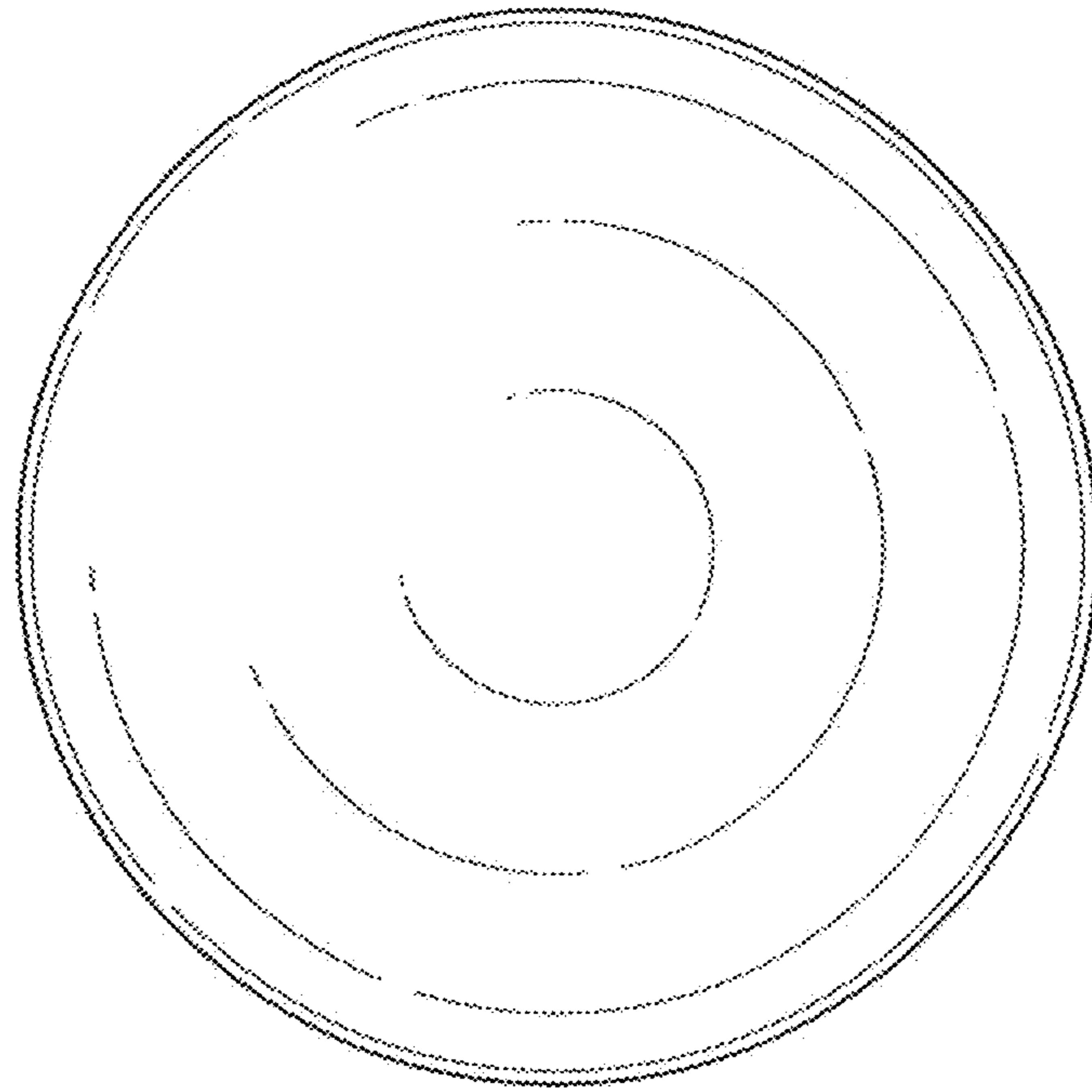

Fig. 6

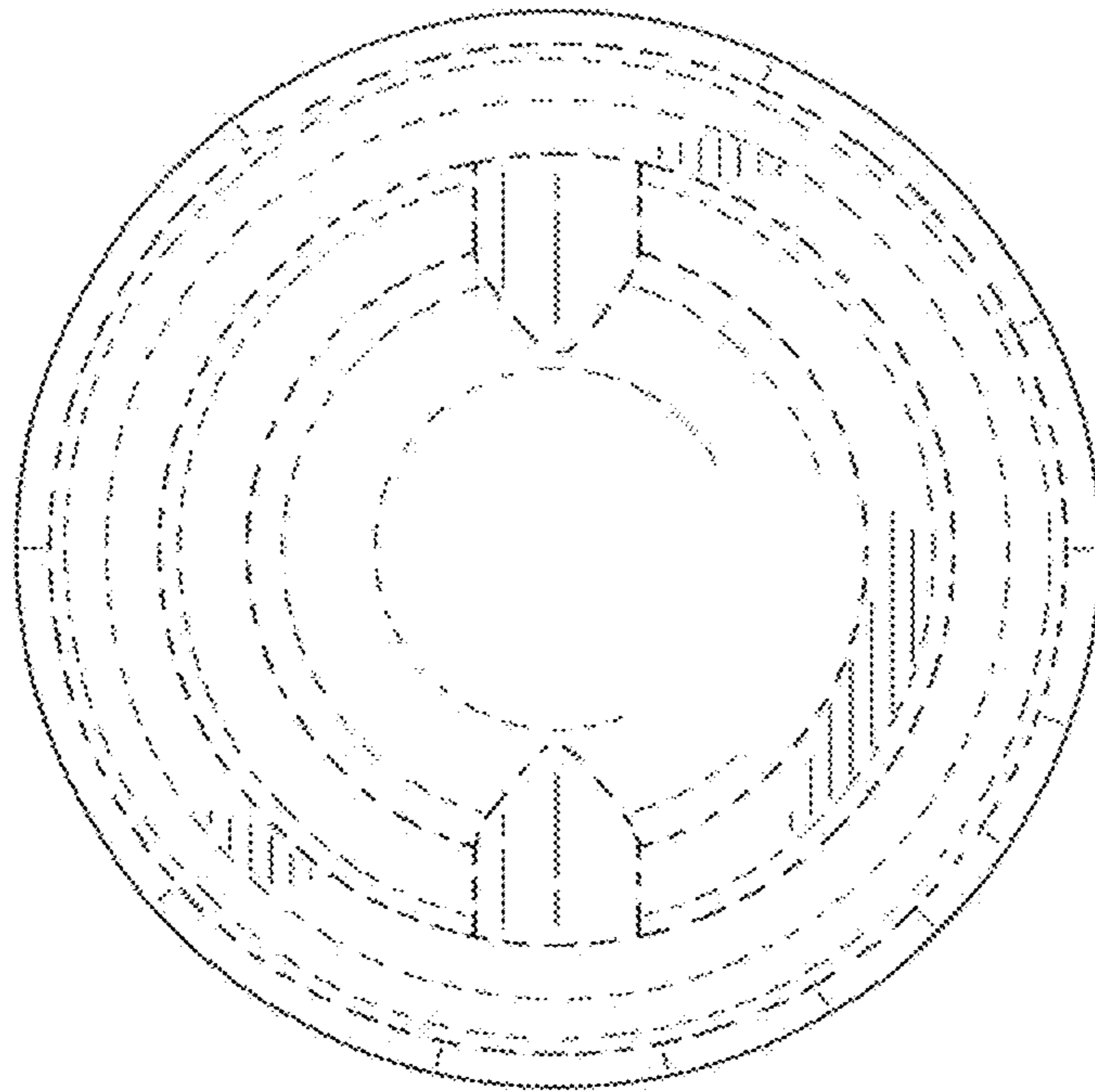

Fig. 7