



US00D837651S

(12) **United States Design Patent**
Jeong

(10) **Patent No.:** **US D837,651 S**

(45) **Date of Patent:** **** Jan. 8, 2019**

(54) **COSMETIC VESSEL**

(71) Applicant: **LG HOUSEHOLD & HEALTH CARE LTD.**, Seoul (KR)

(72) Inventor: **Song Eun Jeong**, Seoul (KR)

(73) Assignee: **LG HOUSEHOLD & HEALTH CARE LTD.**, Seoul (KR)

(**) Term: **15 Years**

(21) Appl. No.: **29/582,272**

(22) Filed: **Oct. 26, 2016**

(30) **Foreign Application Priority Data**

Aug. 19, 2016 (KR) 30-2016-0040588

(51) **LOC (11) Cl.** **09-01**

(52) **U.S. Cl.**
USPC **D9/503; D9/451**

(58) **Field of Classification Search**

USPC D9/434-435, 444-445, 449, 451, 454,
D9/500, 503-504, 516, 529, 549, 558,
D9/629, 715; D3/203.2; D28/4, 8, 76,
D28/91

CPC B65D 1/00; B65D 1/02; B65D 1/0223;
B65D 23/00; B65D 81/00

See application file for complete search history.

(56) **References Cited**

U.S. PATENT DOCUMENTS

D164,929 S * 10/1951 Hobe D9/629
D280,294 S * 8/1985 Resnick D9/441

D405,003 S * 2/1999 Dapsanse D9/504
D435,449 S * 12/2000 Moretti D9/500
D525,131 S * 7/2006 Davies D28/82
D578,393 S * 10/2008 Canamasas Puigbo D9/500
D610,460 S * 2/2010 Nagata D9/504
D621,708 S * 8/2010 Thomas D9/500
D696,555 S * 12/2013 Kolano D7/590
D707,561 S * 6/2014 You D9/454
D793,236 S * 8/2017 Santos D9/503

* cited by examiner

Primary Examiner — Dana Meyrow

(74) *Attorney, Agent, or Firm* — Mintz Levin Cohn Ferris Glovsky and Popeo, P.C.; Kongsik Kim

(57) **CLAIM**

The ornamental design for a cosmetic vessel, as shown and described.

DESCRIPTION

FIG. 1 is a perspective view of a cosmetic vessel according to the present invention.

FIG. 2 is a front view of the cosmetic vessel of FIG. 1.

FIG. 3 is a rear view of the cosmetic vessel of FIG. 1.

FIG. 4 is a left side view of the cosmetic vessel of FIG. 1.

FIG. 5 is a right side view of the cosmetic vessel of FIG. 1.

FIG. 6 is a top view of the cosmetic vessel of FIG. 1; and,

FIG. 7 is a bottom view of the cosmetic vessel of FIG. 1.

1 Claim, 7 Drawing Sheets

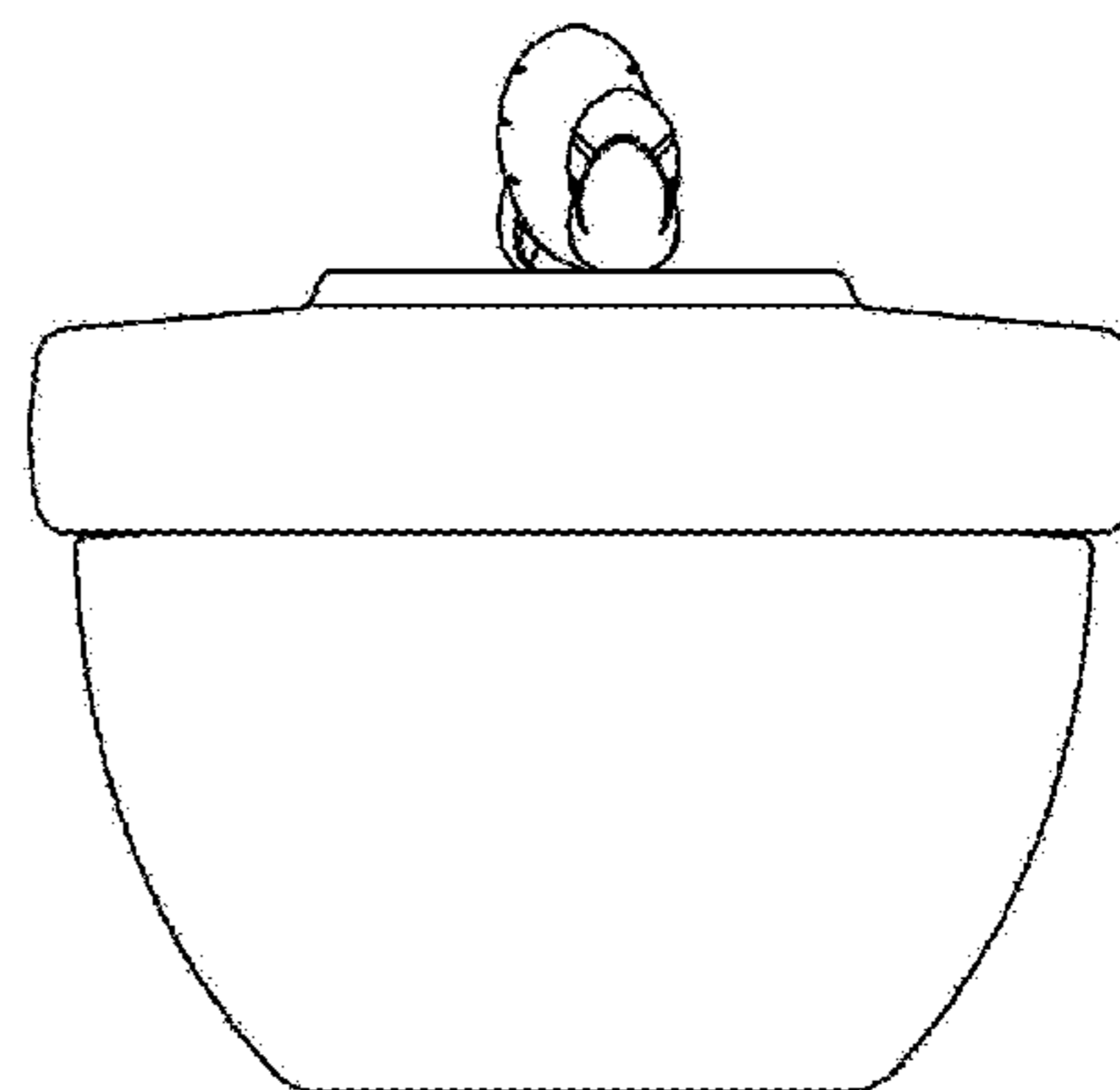
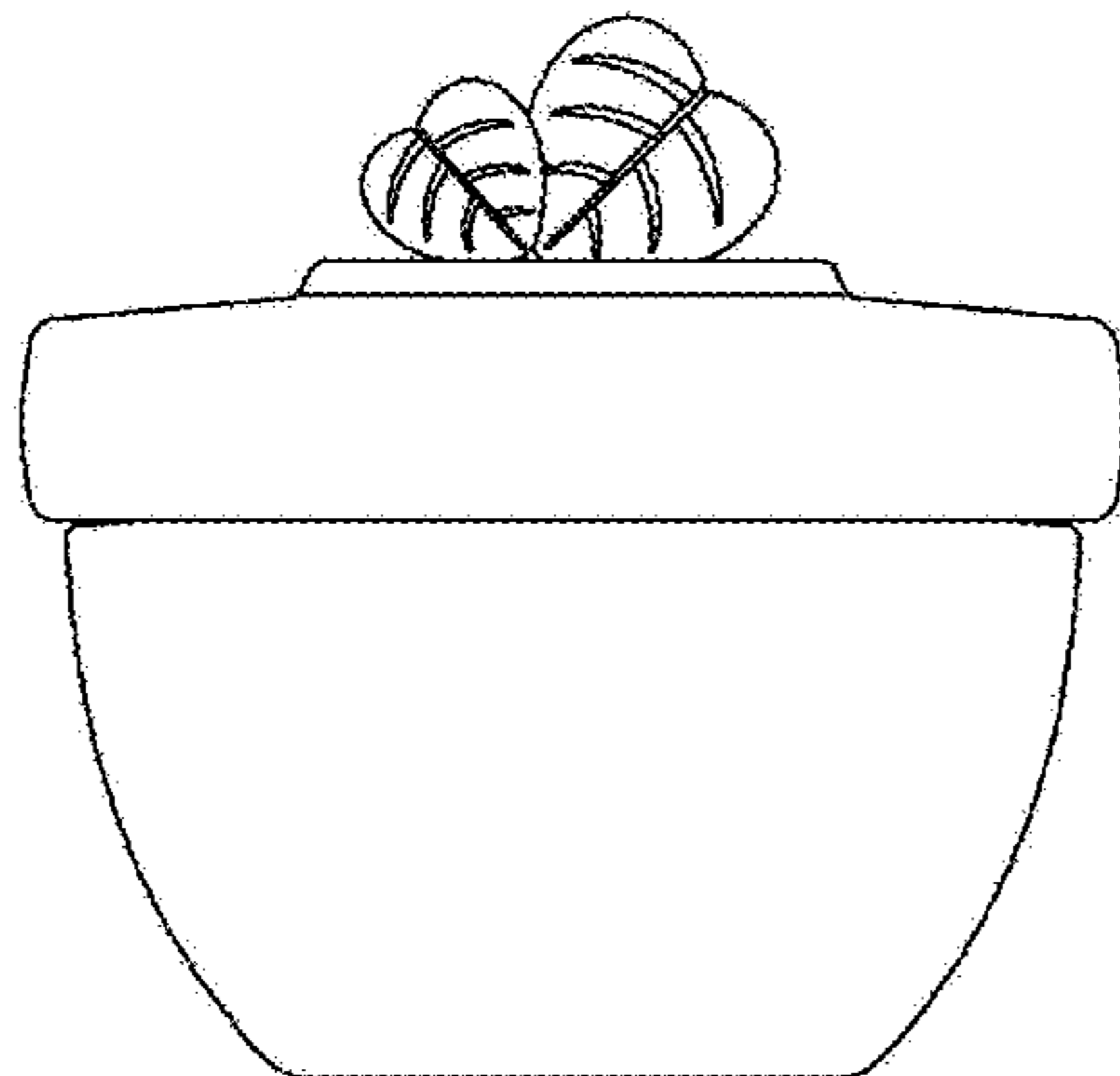

FIG. 1

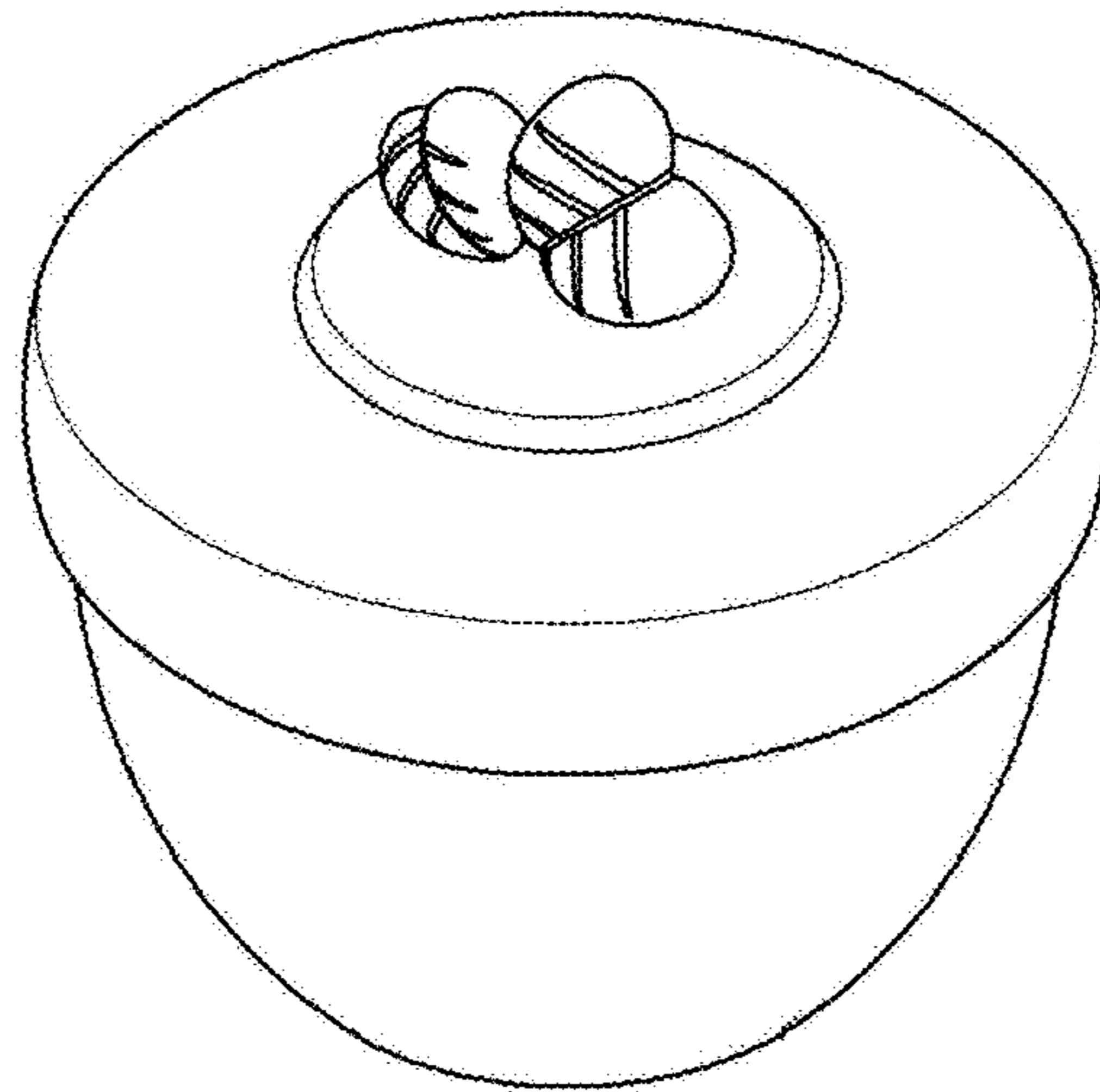

FIG. 2

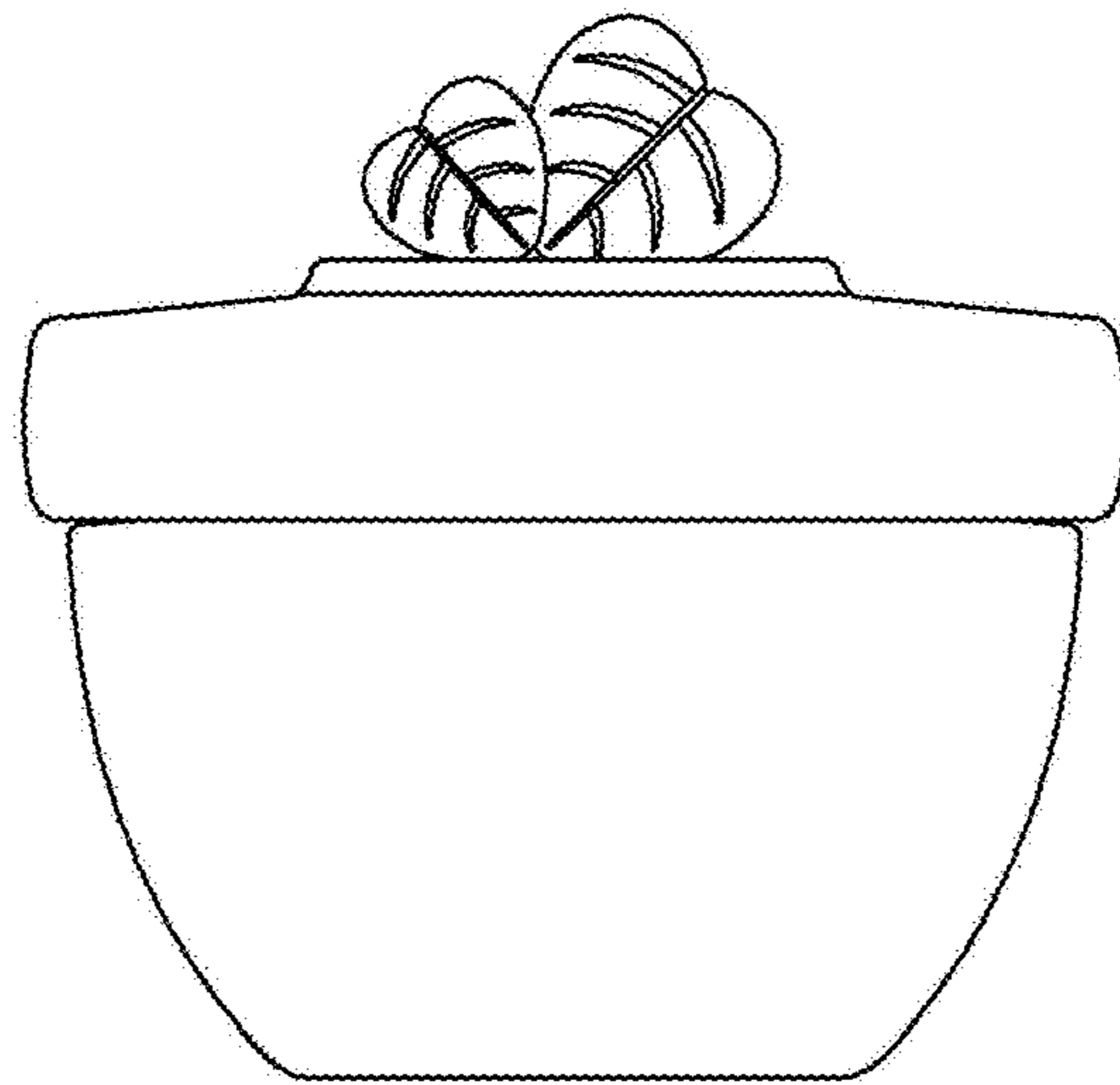

FIG. 3

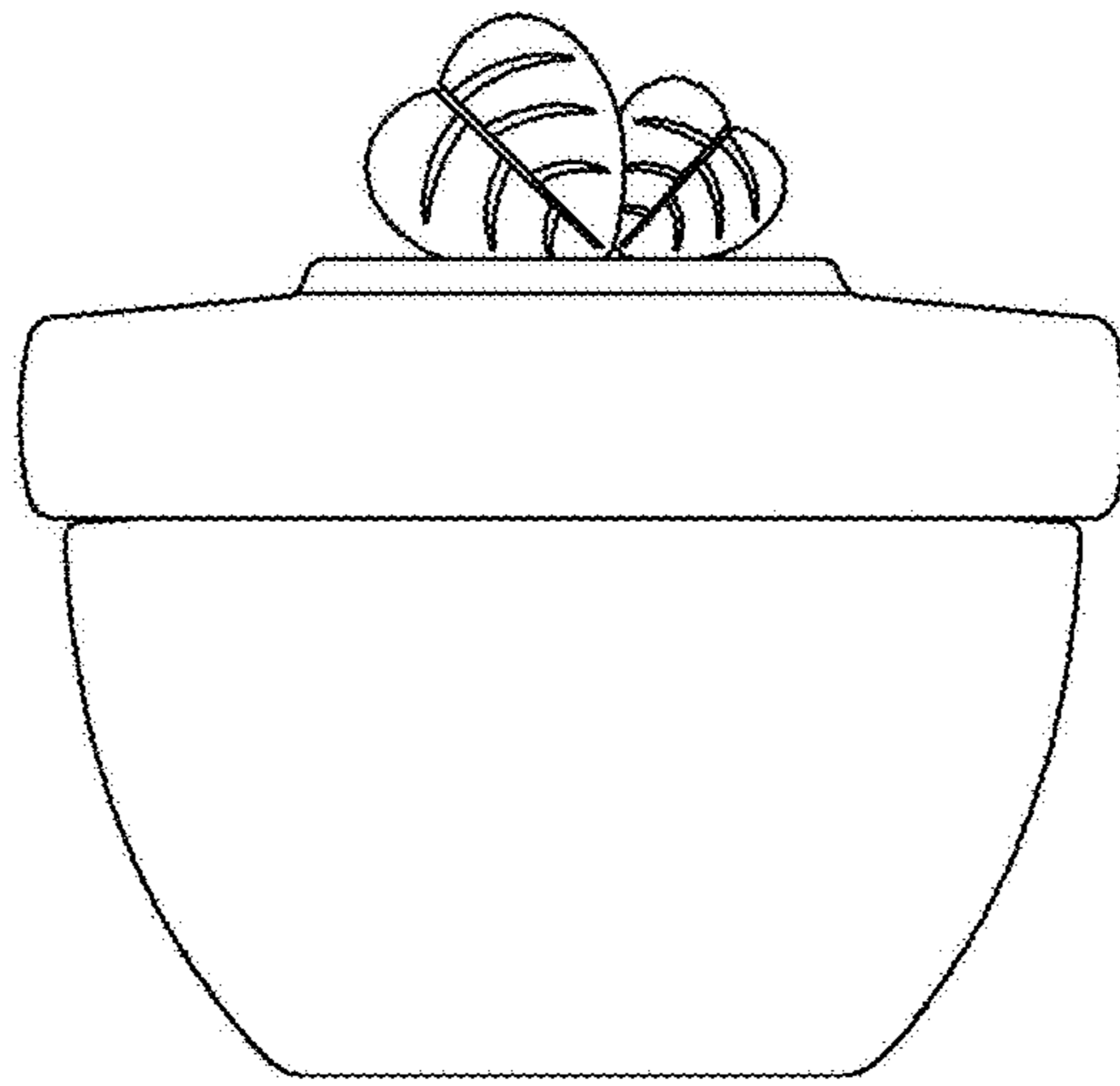

FIG. 4

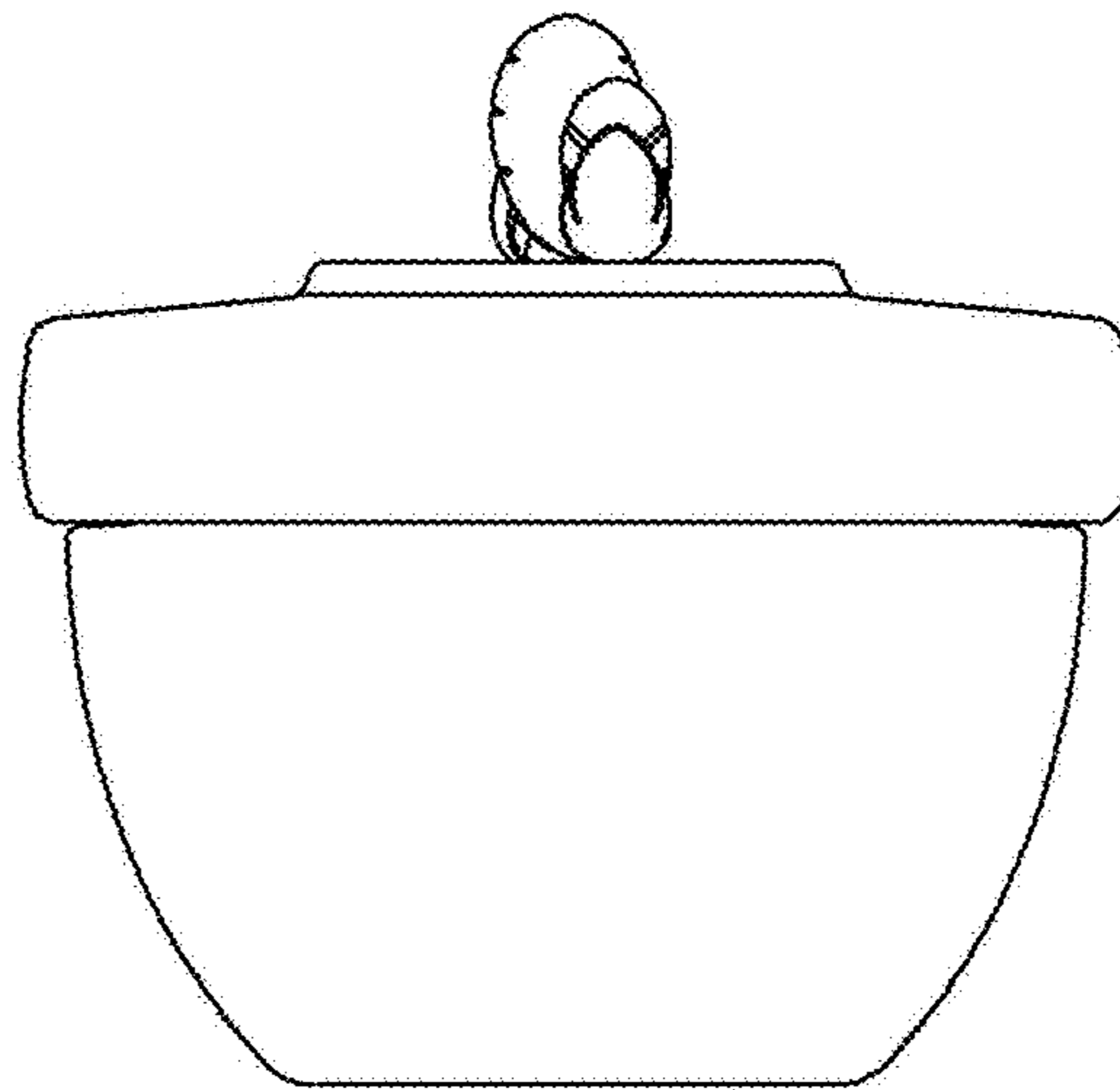

FIG. 5

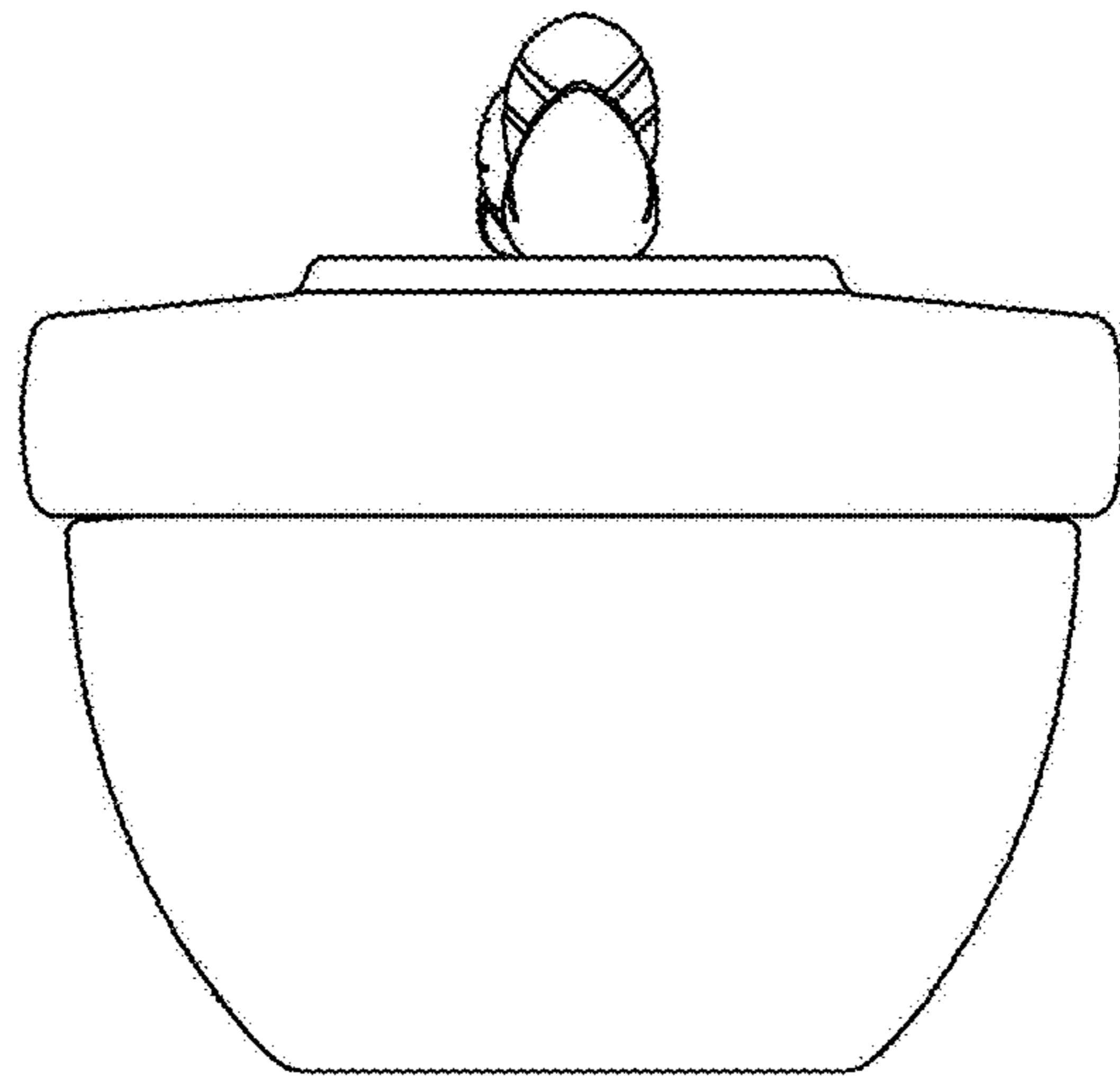

FIG. 6

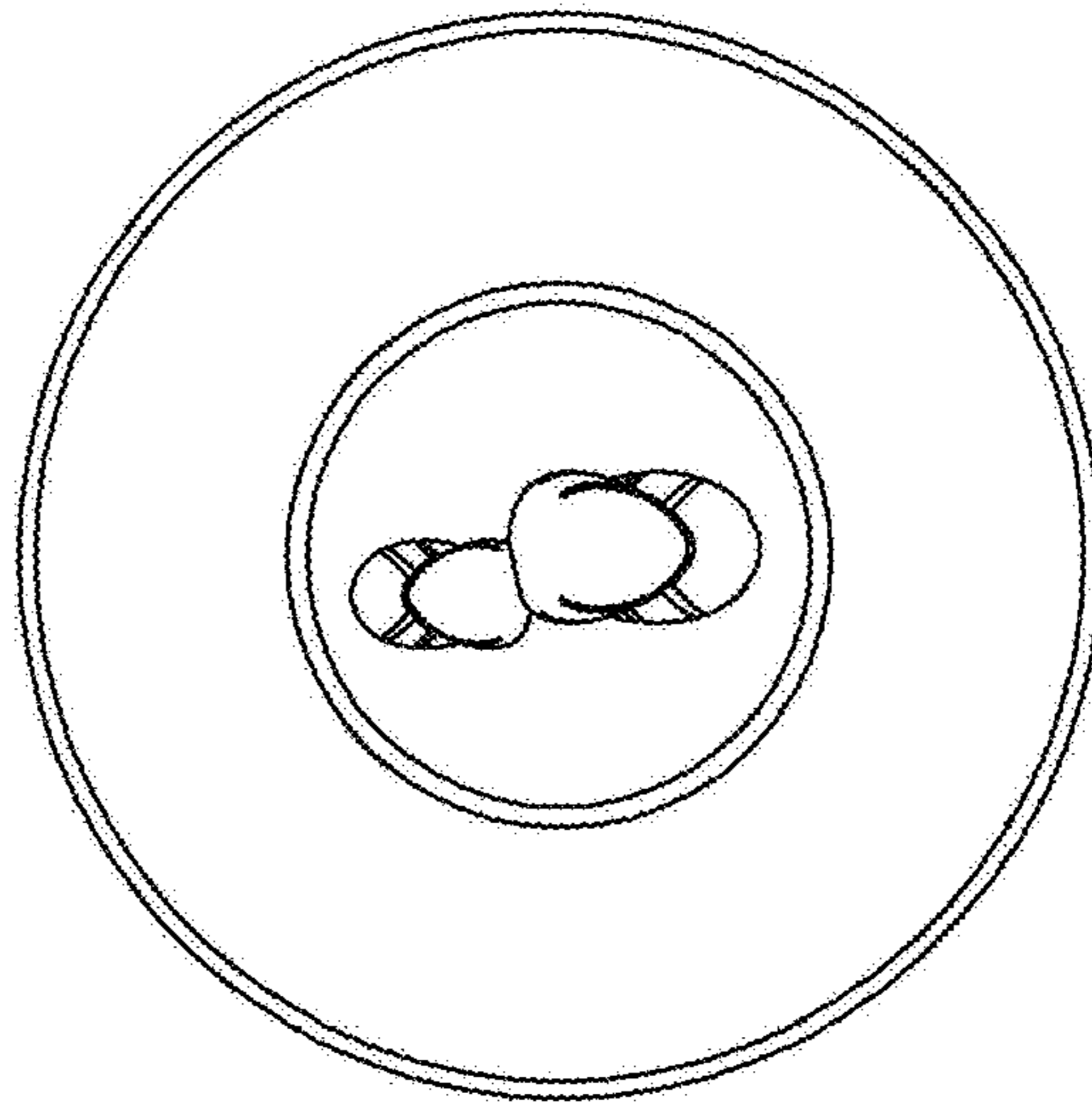

FIG. 7

