



US00D837542S

(12) **United States Design Patent** (10) **Patent No.:** **US D837,542 S**
Nicoll et al. (45) **Date of Patent:** **** Jan. 8, 2019**

- (54) **MODULAR KITCHEN** D223,005 S 2/1972 Genaro et al.
 3,993,376 A 11/1976 Meldahl
 (71) Applicant: **NewAge Products, Inc.**, Vaughan (CA) D245,619 S 8/1977 Robinson
 4,054,338 A 10/1977 Martin
 (72) Inventors: **David Wesley Nicoll**, Mississauga D246,496 S * 11/1977 Weckwerth D34/1
 (CA); **Robert Vandenharm**, North York 4,090,755 A 5/1978 Johnson
 (CA); **Parag Shah**, Toronto (CA); 4,138,000 A 2/1979 Hartup
Frank Spano, Toronto (CA); **Edward** 4,589,445 A 5/1986 Sanchez Aguilar et al.
Reyes, Maple (CA) 4,592,603 A 6/1986 Adams et al.
 4,759,193 A * 7/1988 Dehring F25D 11/02
 62/258
 (73) Assignee: **NewAge Products, Inc.**, Vaughan,
 Ontario (CA) D301,526 S 6/1989 Jacobs et al.
 D301,527 S 6/1989 Jacobs et al.
 D322,185 S 12/1991 McInnis
 D331,334 S 12/1992 Hollington
 D378,454 S 3/1997 Miller et al.
 (**) Term: **15 Years** D386,917 S 12/1997 Blevio
 5,871,029 A 2/1999 Peteri et al.
 (21) Appl. No.: **29/605,052** 5,873,643 A 2/1999 Burgess, Jr. et al.
 D408,538 S 4/1999 Simpkins et al.
 (22) Filed: **May 23, 2017** 5,918,432 A * 7/1999 Mahone A47B 47/00
 52/220.2

Related U.S. Application Data

- (62) Division of application No. 29/551,930, filed on Jan. 19, 2016, now Pat. No. Des. 793,772.
 (51) **LOC (11) Cl.** **06-01**
 (52) **U.S. Cl.**
 USPC **D6/336**
 (58) **Field of Classification Search**
 USPC D6/34, 335, 349, 396, 432, 433, 445,
 D6/446, 447, 448, 470, 510, 559, 663,
 D6/703, 719; D34/1, 12, 27
 CPC . A47B 47/00; H05K 5/00; H05K 7/14; H05K
 7/20; F16B 12/00; F25D 11/02; F25D
 31/00
 See application file for complete search history.

- D434,584 S * 12/2000 Zaidman D6/703
 D439,458 S 3/2001 Melillo
 D439,782 S 4/2001 Melillo
 D440,427 S 4/2001 Melillo
 D440,428 S 4/2001 Melillo
 D446,408 S 8/2001 Mathieu et al.
 6,273,138 B1 8/2001 Yoney
 D461,972 S * 8/2002 Everett D6/663
 D462,227 S 9/2002 Alden et al.
 D492,857 S * 7/2004 Harwanko D6/663
 D494,004 S 8/2004 Chapman
 D496,540 S 9/2004 Moon et al.
 D503,839 S 4/2005 Schmidt et al.
 D507,914 S * 8/2005 Schmidt D6/703
 7,021,308 B2 4/2006 Caruso
 7,111,852 B2 9/2006 Woods et al.
 D533,009 S 12/2006 Pai
 D533,010 S 12/2006 Pai
 D535,846 S 1/2007 Debord et al.
 D542,056 S 5/2007 Puente et al.
 D549,501 S * 8/2007 Gaska D6/703.3
 D558,483 S 1/2008 Bertch et al.
 D560,416 S 1/2008 Sedberry et al.
 D562,597 S 2/2008 Weatherly et al.
 D569,168 S 5/2008 Pai
 D571,602 S 6/2008 Chung
 7,389,796 B2 6/2008 Vilhelmsen
 D581,199 S 11/2008 Chau
 D584,562 S 1/2009 Chau et al.
 D586,609 S 2/2009 Chau
 D602,723 S 10/2009 Daino et al.

(56) **References Cited**

U.S. PATENT DOCUMENTS

- 1,527,531 A 2/1925 Topazzi
 2,449,433 A 9/1948 Wheelock
 2,725,274 A 11/1955 Stivale
 D198,887 S 8/1964 Grande
 3,158,016 A * 11/1964 Fay E05C 9/025
 292/143
 3,314,740 A 4/1967 Lappin et al.
 3,471,947 A 10/1969 Genser

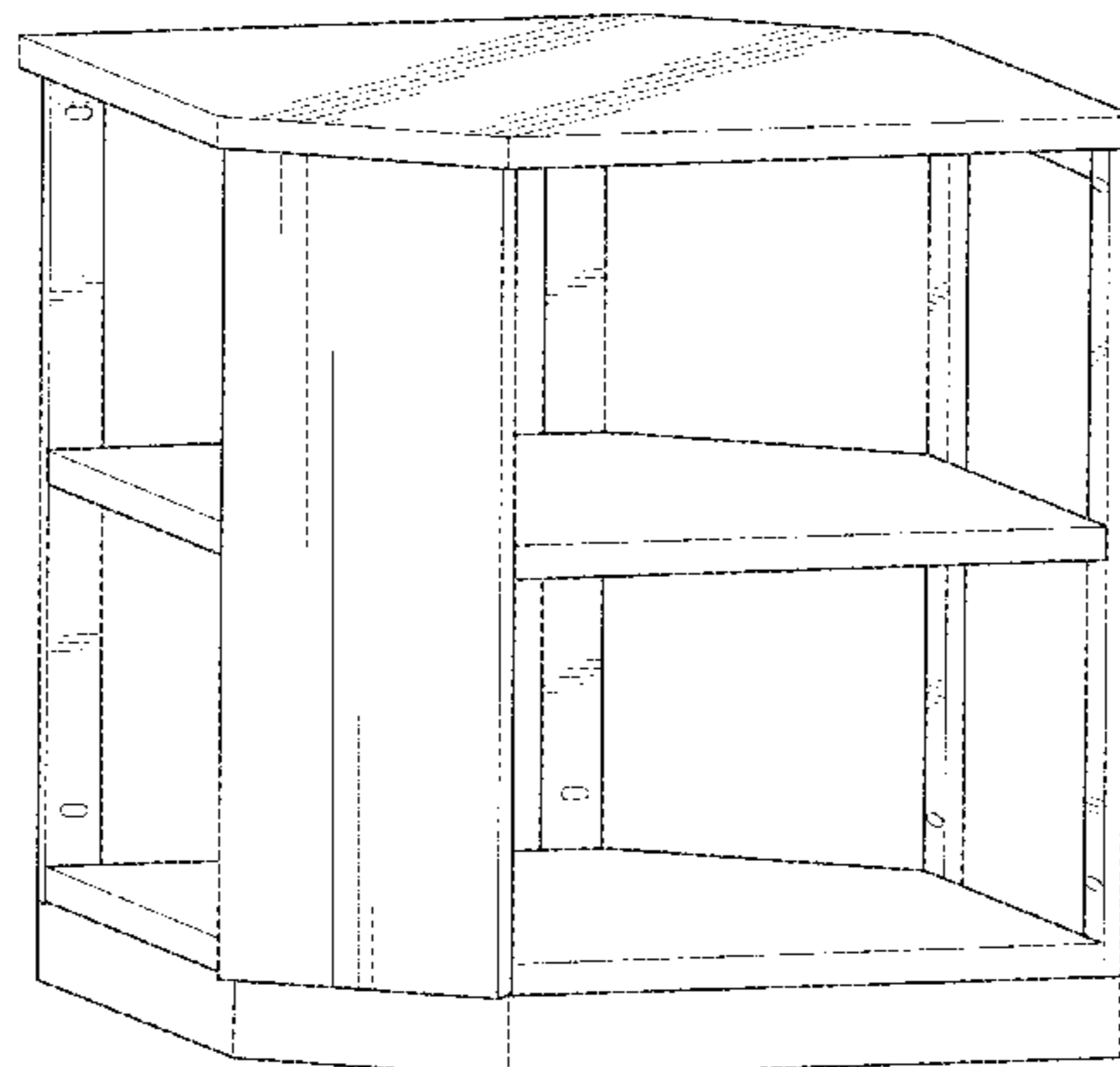

D608,516	S	*	1/2010	Cantrell	D34/1
D618,019	S	*	6/2010	Gaska	D6/703.3
D635,814	S		4/2011	Leavens		
8,070,076	B2		12/2011	Erickson et al.		
D651,829	S		1/2012	Ma		
D658,217	S		4/2012	Wenning		
D660,073	S		5/2012	Chung		
D661,538	S		6/2012	Chung		
D665,201	S		8/2012	Gaska et al.		
D666,034	S	*	8/2012	Gaska	D6/703.3
D667,652	S		9/2012	Wang		
D672,989	S	*	12/2012	McManic	D6/668.1
D673,387	S		1/2013	Pazhoor		
D679,937	S		4/2013	Chung		
D684,802	S		6/2013	Johnson et al.		
D687,669	S		8/2013	Chung		
D688,510	S		8/2013	Stirn		
D688,512	S		8/2013	Chung		
D693,624	S		11/2013	Chung		
D694,056	S		11/2013	Dahle		
D694,568	S		12/2013	Alden et al.		
D697,357	S		1/2014	Goecke et al.		
8,621,681	B2		1/2014	Macan et al.		
D711,673	S	*	8/2014	Lim	D6/703
D712,191	S		9/2014	Chung		
D712,692	S	*	9/2014	McManic	D6/702
D716,086	S	*	10/2014	Bender	D6/703
D717,097	S		11/2014	Lin		
8,931,300	B2	*	1/2015	Smith	F25D 23/065 62/443
D722,810	S		2/2015	Chung		
D723,321	S		3/2015	Chung		
D723,322	S		3/2015	Strauch et al.		
D723,860	S		3/2015	Chung		
D726,491	S		4/2015	Witzel et al.		
D731,843	S		6/2015	Chung		
D732,874	S		6/2015	Chung		
D736,026	S		8/2015	Kam et al.		
D737,092	S		8/2015	Lin		
D744,775	S		12/2015	Yang		
D747,909	S		1/2016	Simms, II		
D747,911	S		1/2016	Sheppard		
D748,423	S		2/2016	Chiang		
D753,430	S		4/2016	Wagner		
D769,667	S		10/2016	Ting		
D769,668	S		10/2016	Lally		
D773,214	S		12/2016	Ben Avi		
D773,229	S		12/2016	Jaggard et al.		
D775,866	S		1/2017	Ben Avi		
D776,476	S		1/2017	Euwer		
D784,557	S		4/2017	Thuma et al.		
D807,085	S	*	1/2018	Vandenhams	D6/671.1
D820,010	S	*	6/2018	Reyes	D6/663
9,993,073	B2	*	6/2018	Wakiya	A47B 47/0066
2002/0078865	A1		6/2002	Kuvshnikov		
2004/0169155	A1		9/2004	Chen et al.		
2005/0035697	A1		2/2005	Chen		
2005/0241701	A1		11/2005	Bender		
2006/0196563	A1		9/2006	Liles et al.		
2007/0204858	A1		9/2007	Abelbeck		
2007/0251590	A1		11/2007	Weinstein		
2008/0121118	A1		5/2008	Sikes		
2008/0229937	A1		9/2008	Stephen et al.		
2010/0132689	A1		6/2010	Contarino, Jr.		
2010/0297321	A1		11/2010	Strauch		
2011/0219958	A1		9/2011	Noble		
2013/0112088	A1		5/2013	May		
2014/0060394	A1		3/2014	Yaman et al.		
2014/0132129	A1		5/2014	Deneweth et al.		
2014/0318524	A1		10/2014	Measom et al.		
2015/0004297	A1		1/2015	Pothetes		
2015/0218864	A1		8/2015	Simon		
2016/0198895	A1		7/2016	Turner		
2016/0208837	A1		7/2016	Chang		
2016/0360924	A1		12/2016	Bruin-Slot		

FOREIGN PATENT DOCUMENTS

CN	203096835	U	7/2013
GB	2 397 519	B	11/2005
WO	WO 87/06861	A1	11/1987

OTHER PUBLICATIONS

English language abstract and computer-generated English language translation for CN 203096835 extracted from espacenet.com database on Jun. 15, 2016, 7 pages.

“Sliding Kitchen Countertop”, downloaded from <http://thedecoratingdiva.com/milan-design-week-10-kitchen-bath-trends/> on Sep. 24, 2014, 1 page.

“Sliding Kitchen Countertop”, downloaded from http://www.contemporist.com/2011/06/07/the-sliding-top-by-minimal/sliding_top_0706_11_02/ on Sep. 25, 2014, 1 page.

“Outdoor Kitchen Cabinet”, downloaded from http://sell_lulusoso.com/upload/20120305/Stainless_steel_outdoor_kitchen_cabinet.jpg on Oct. 17, 2014, 1 page.

“Outdoor Kitchen Cabinet”, downloaded from <http://bestoutdoorcabinets.com/outstanding-viking-stainless-steel-outdoor-cabinets-also-chrome-faucet-with-brushed-nickel-hardware-and-white-plastic-cutting-board-on-small-porcelain-tile-countertops-with-mosaic-tile-edge-trim/> on Oct. 17, 2014, 2 pages.

“Portable Outdoor Kitchen Island”, downloaded from http://www.outdoordesignstudio.com/soldura_outdoor_furniture_and_storage.html#portable_kitchen_islands on Oct. 29, 2014, 1 page.

“Outdoor Kitchen Sink Module”, downloaded from <http://www.rbrooksandson.com/grills/grill-accessories> on Oct. 29, 2014, 1 page.

“Outdoor Kitchen Island”, downloaded from <http://cacakitchen.blogspot.com/2013/08/grillsislandskitchenstraight-outdoor.html> on Oct. 29, 2014, 1 page.

“Fuego Modular Series FM20MOD”, downloaded from www.ajmadison.com/cgi-bin/ajmadison/FM20MOD.html on Oct. 29, 2014, 1 page.

“Geneva Cabinet”, downloaded from <http://www.genevacabinet.com> on Oct. 29, 2014, 1 page.

“Ozark River Portable Sinks 26"×18" Nature Premier Single Bowl Outdoor Portable Sink with Storage Cabinet-Finish: Power Coated Stainless Steel”, downloaded from <http://www.sears.com/ozark-river-portable-sinks-26inch-x-18inch-nature/p-SPM10940678315?prdNo+11&blockNo+11&blockType+G11> on Oct. 29, 2014, 1 page.

“Outdoor Patio Storage Cabinet”, downloaded from <http://bestoutdoorcabinets.com/sensational-outdoor-patio-storage-cabinet-from-cedar-wood-planks-with-galvanized-steel-countertop-and-rubber-locking-casters/> on Oct. 29, 2014, 1 page.

“Outdoor Wicker Storage Cabinet”, downloaded from <http://goldeneagleoutdoor.en.made-in-china.com/productimage/nSjEavLCJfkr-2f1j00mZftQbJahhqV/China-New-Outdoor-Wicker-Storage-Cabinet-B0014-html> on Oct. 29, 2014, 1 page.

“30 Inch Storage Cabinet-2 Doors”, downloaded from <http://kalamazoogourmet.com/products/30-storage-cabinet-2-doors> on Oct. 29, 2014, 1 page.

“Horizontal Outdoor Storage Shed”, downloaded from <http://cabinets.apluswhs.com/outdoor-storage-cabinets/horizontal-outdoor-storage-shed/> on Oct. 29, 2014, 1 page.

“Purchasing Outdoor Kitchen Cabinets”, downloaded from <http://dhcabinetry.com/purchasing-outdoor-kitchen-cabinets/> on Oct. 17, 2014, 3 pages.

“Kalamazoo Outdoor Gourmet Products”, downloaded from <http://www.archiexpo.com/prod/kalamazoo-outdoor-gourmet/garden-stainless-steel-sink-cabinets-57824-899620.html> on Oct. 17, 2014, 1 page.

“Outdoor Storage Cabinet Entrancing Plastic Outdoor Cabinet Storage”, downloaded from <http://www.homedecor.pics/outdoor-kitchen-cabinets-plastic/26/outdoor-storage-cabinet-entrancing-plastic-outdoor-cabinet-storage/> on Oct. 17, 2014, 1 page.

“Challenger Outdoor Kitchen”, downloaded from <http://www.firesideoutdoorkitchens.com/wp-content/uploads/2013/07/challenger-outdoor-kitchen-featured.jpg> on Oct. 17, 2014, 1 page.

“Stainless Steel Classic 5-Piece 160×36×24” in. Outdoor Kitchen Cabinet Set with Covers”, The Home Depot; downloaded from <http://www.homedepot.com/p/NewAge-Products-Stainless-Steel-Classic-5-Piece-160x36x24-in-Outdoor-Kitchen-Cabinet-Set-with-Covers-65972/207163552> on Jun. 1, 2017, 8 pages.

* cited by examiner

Primary Examiner — Susan Bennett Hattan

Assistant Examiner — Suzanne E Tisdell

(74) *Attorney, Agent, or Firm* — Howard & Howard Attorneys PLLC

(57) **CLAIM**

An ornamental design for a modular kitchen, as shown and described.

DESCRIPTION

FIG. 1 is a perspective view of an embodiment of a modular kitchen;

FIG. 2 is a perspective view of a corner cabinet of the modular kitchen of FIG. 1;

FIG. 3 is a front elevational view of the corner cabinet of FIG. 2;

FIG. 4 is a rear elevational view of the corner cabinet of FIG. 2;

FIG. 5 is a left side elevational view of the corner cabinet of FIG. 2;

FIG. 6 is a right side elevational view of the corner cabinet of FIG. 2;

FIG. 7 is a top plan view of the corner cabinet of FIG. 2;

FIG. 8 is a bottom plan view of the corner cabinet of FIG. 2;

FIG. 9 is a perspective view of another embodiment of a modular kitchen;

FIG. 10 is a perspective view of a corner cabinet of the modular kitchen of FIG. 9;

FIG. 11 is a front elevational view of the corner cabinet of FIG. 10;

FIG. 12 is a rear elevational view of the corner cabinet of FIG. 10;

FIG. 13 is a left side elevational view of the corner cabinet of FIG. 10;

FIG. 14 is a right side elevational view of the corner cabinet of FIG. 10;

FIG. 15 is a top plan view of the corner cabinet of FIG. 10;

and,

FIG. 16 is a bottom plan view of the corner cabinet of FIG. 10.

The broken lines, depicted as dot-dot-dot lines, set forth in the drawings depict features of the modular kitchen that form no part of the claimed design.

1 Claim, 10 Drawing Sheets

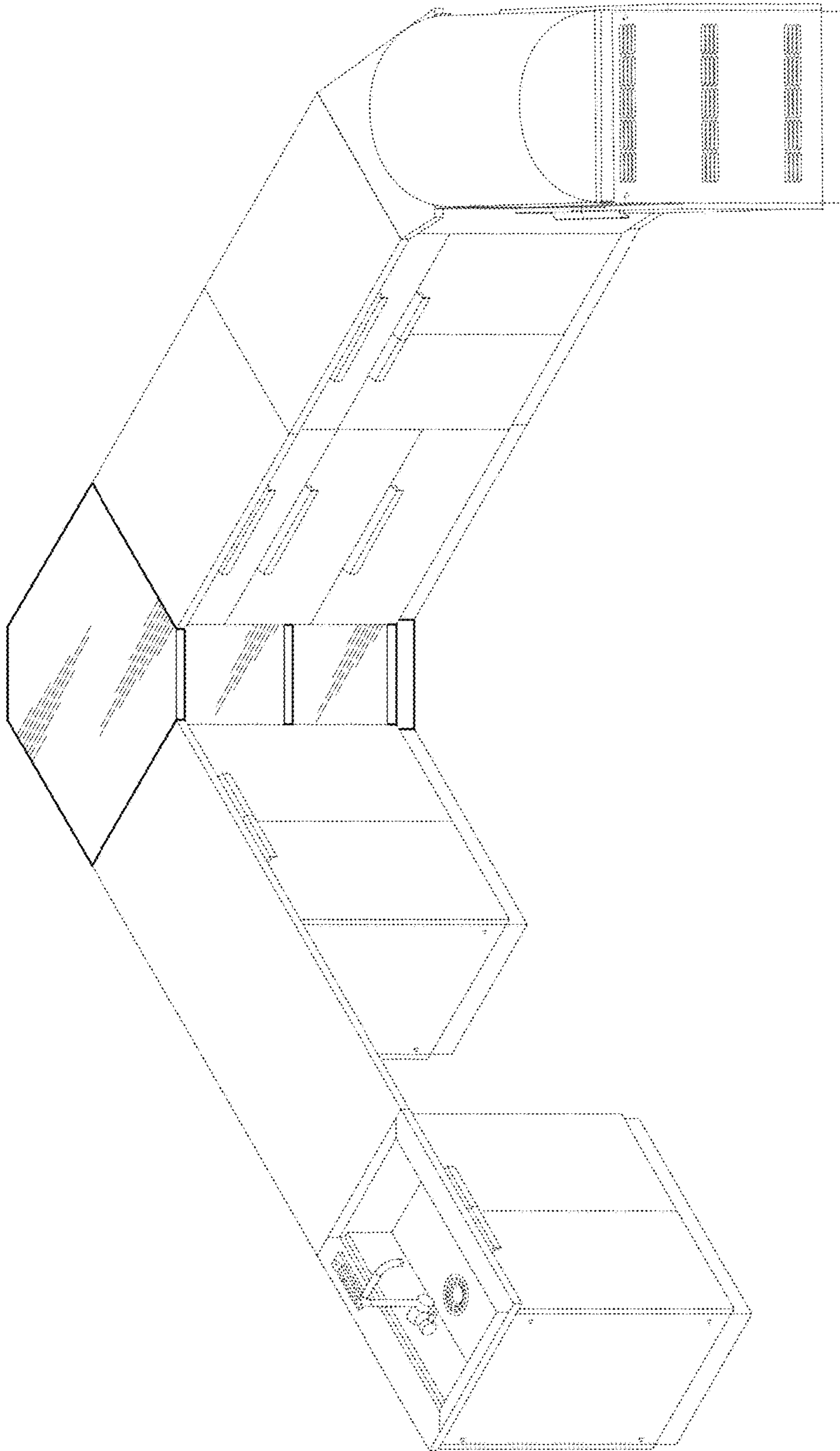

FIG. 1

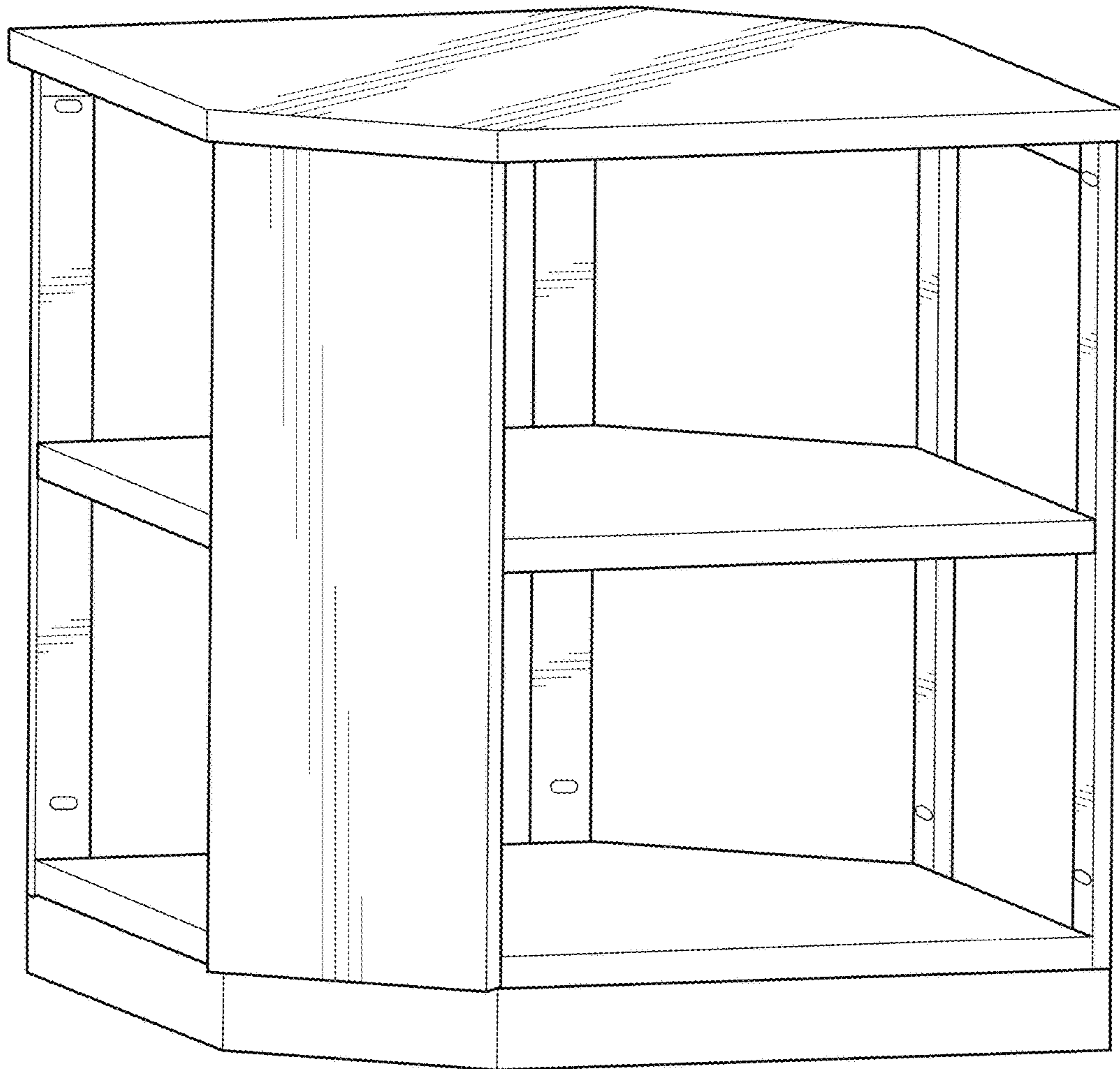

FIG. 2

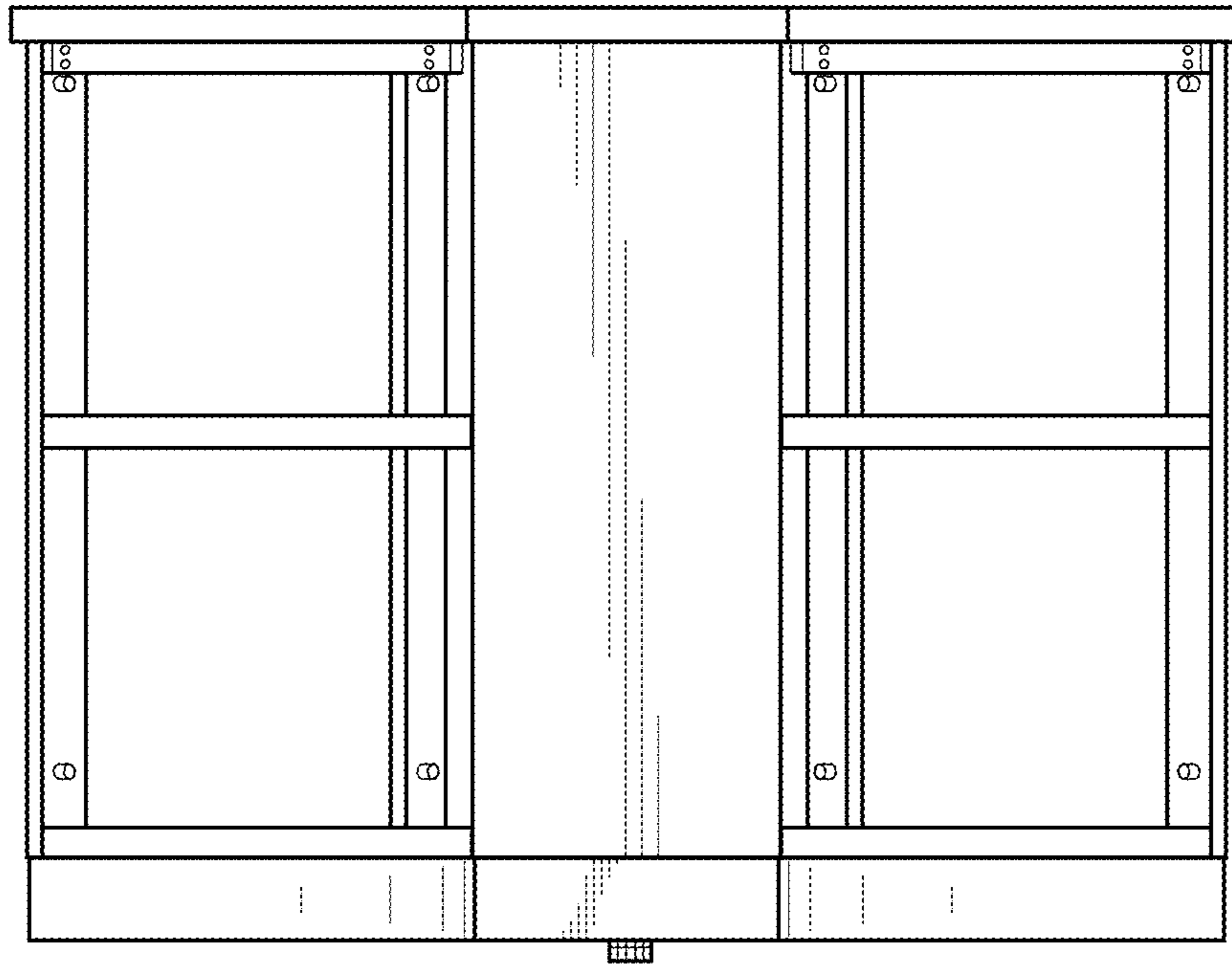

FIG. 3

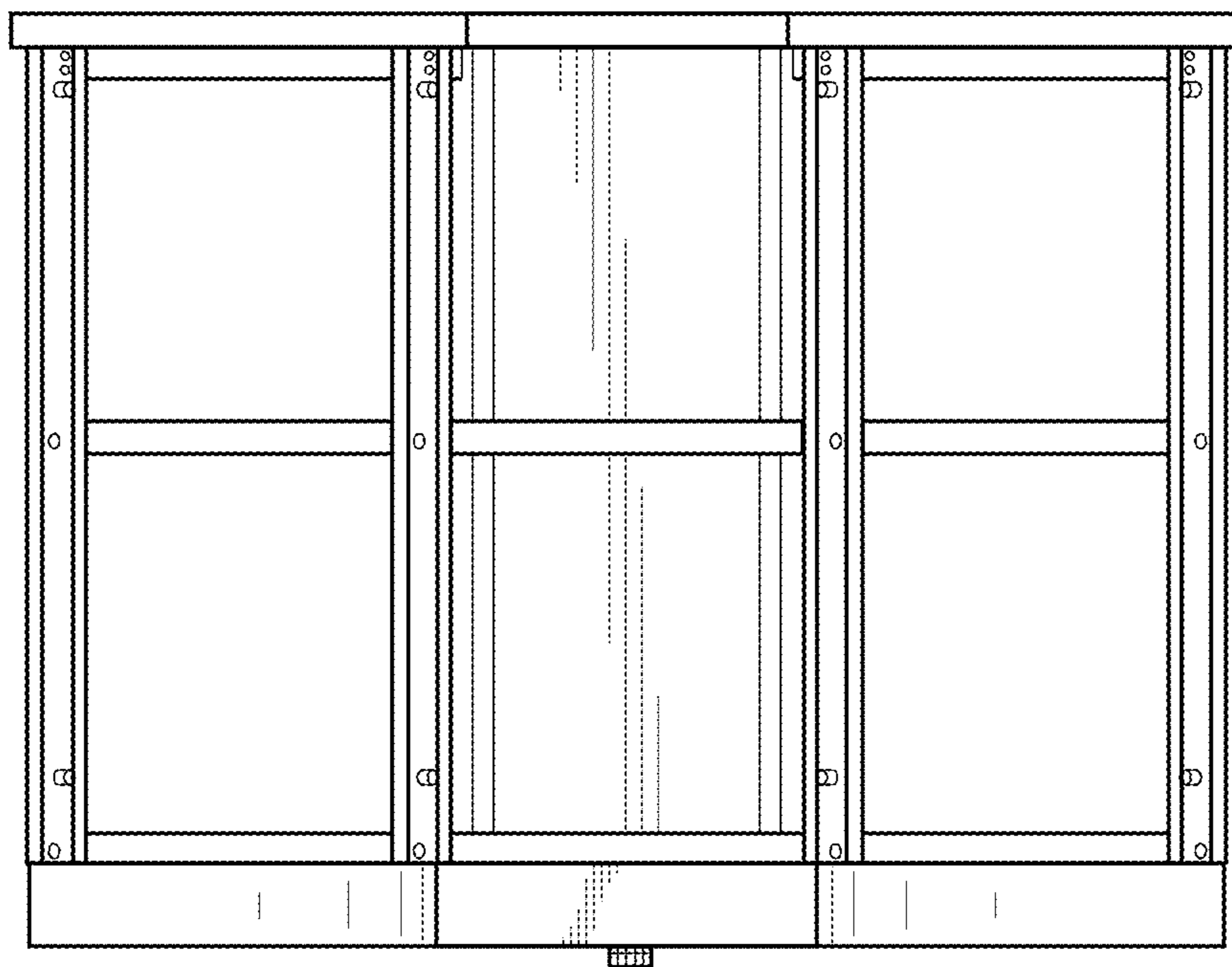

FIG. 4

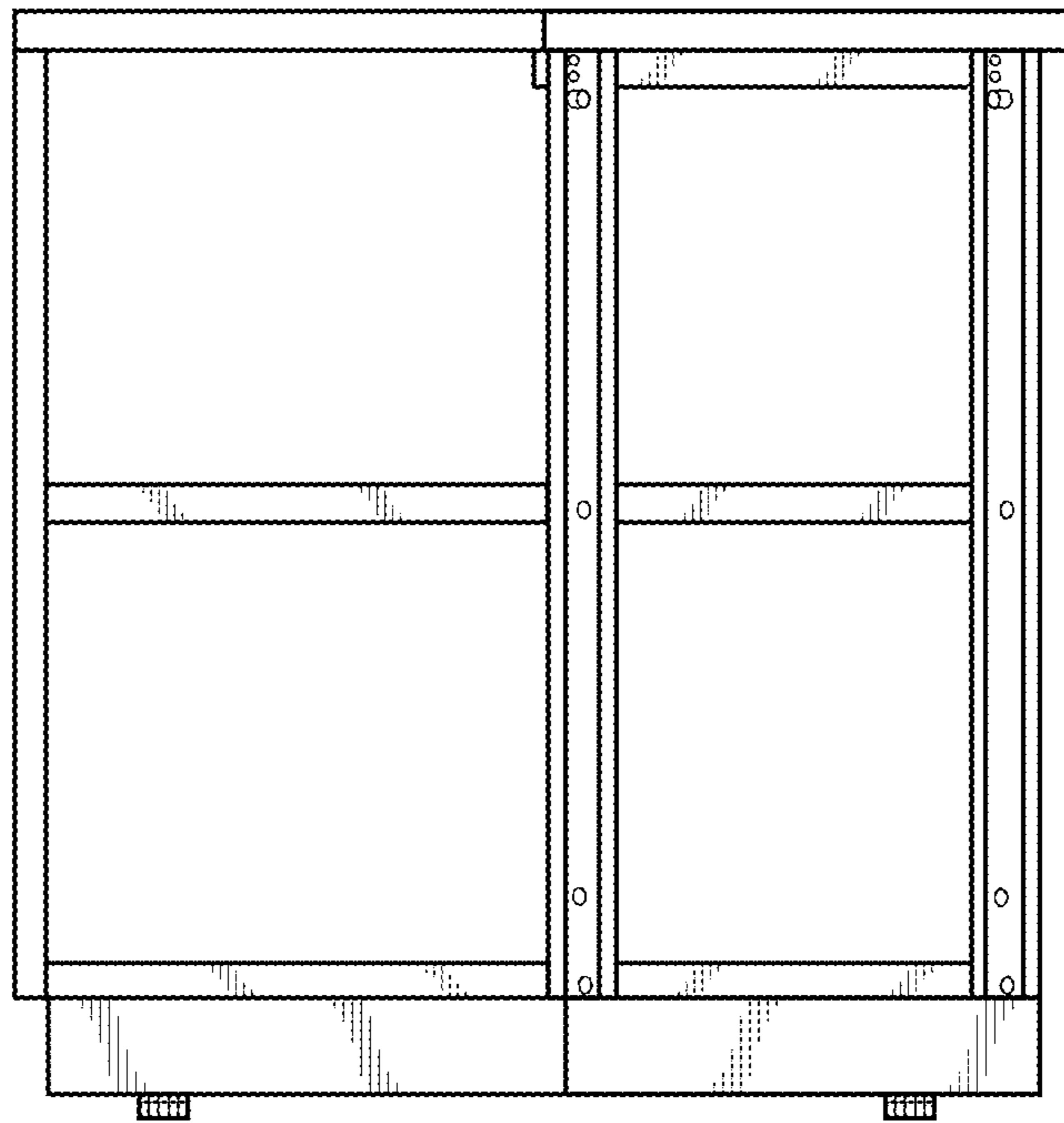

FIG. 5

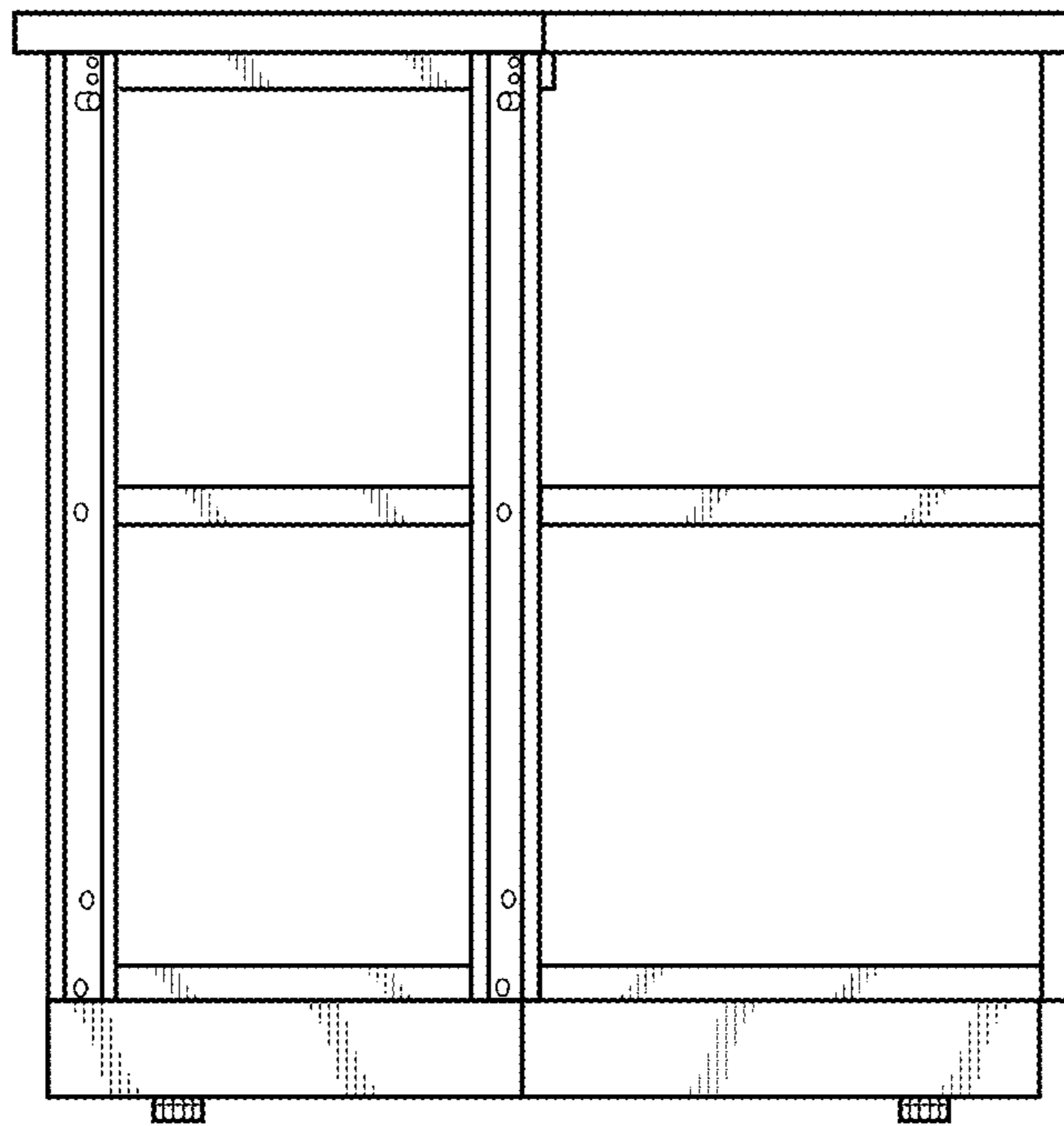

FIG. 6

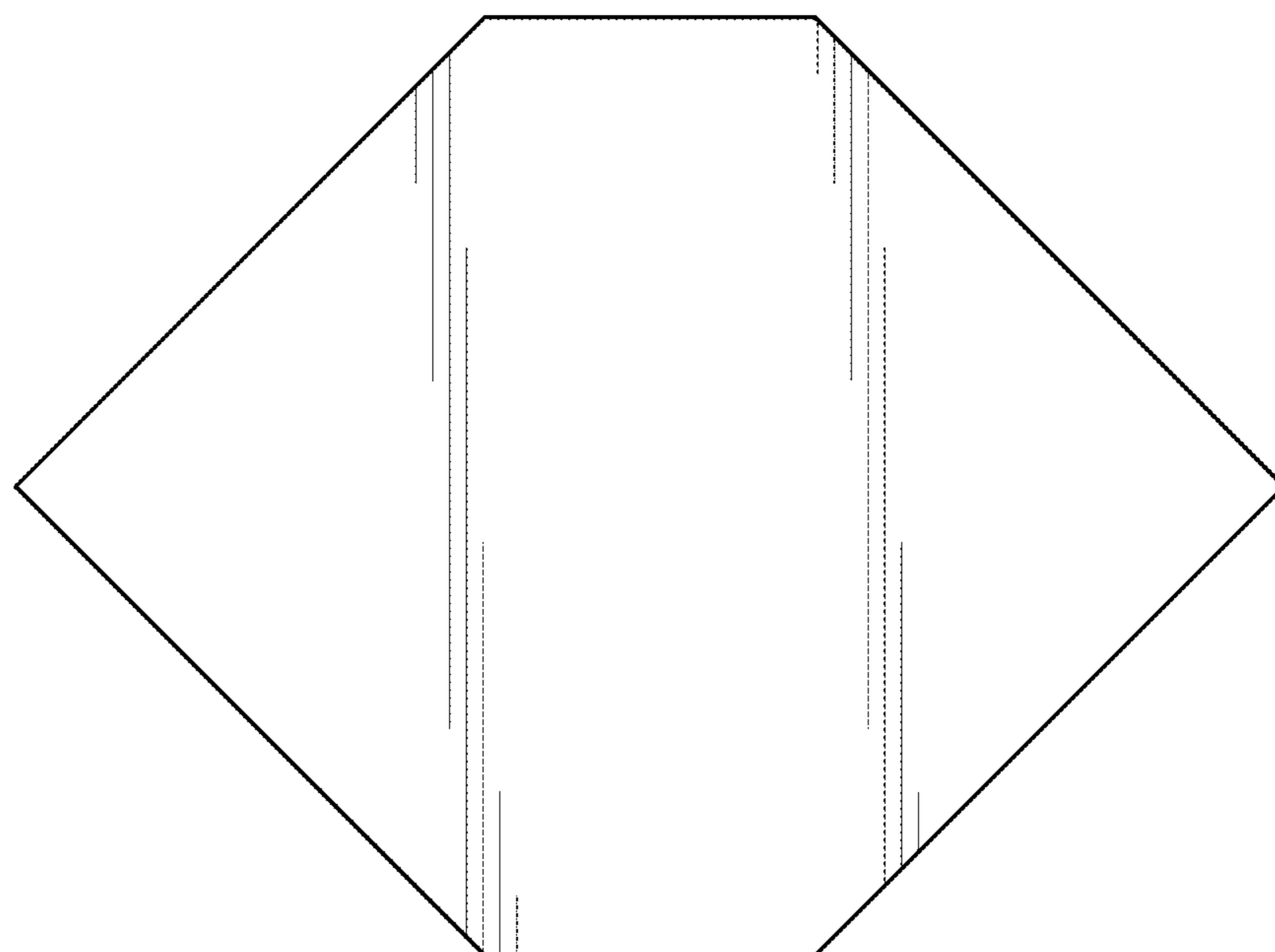

FIG. 7

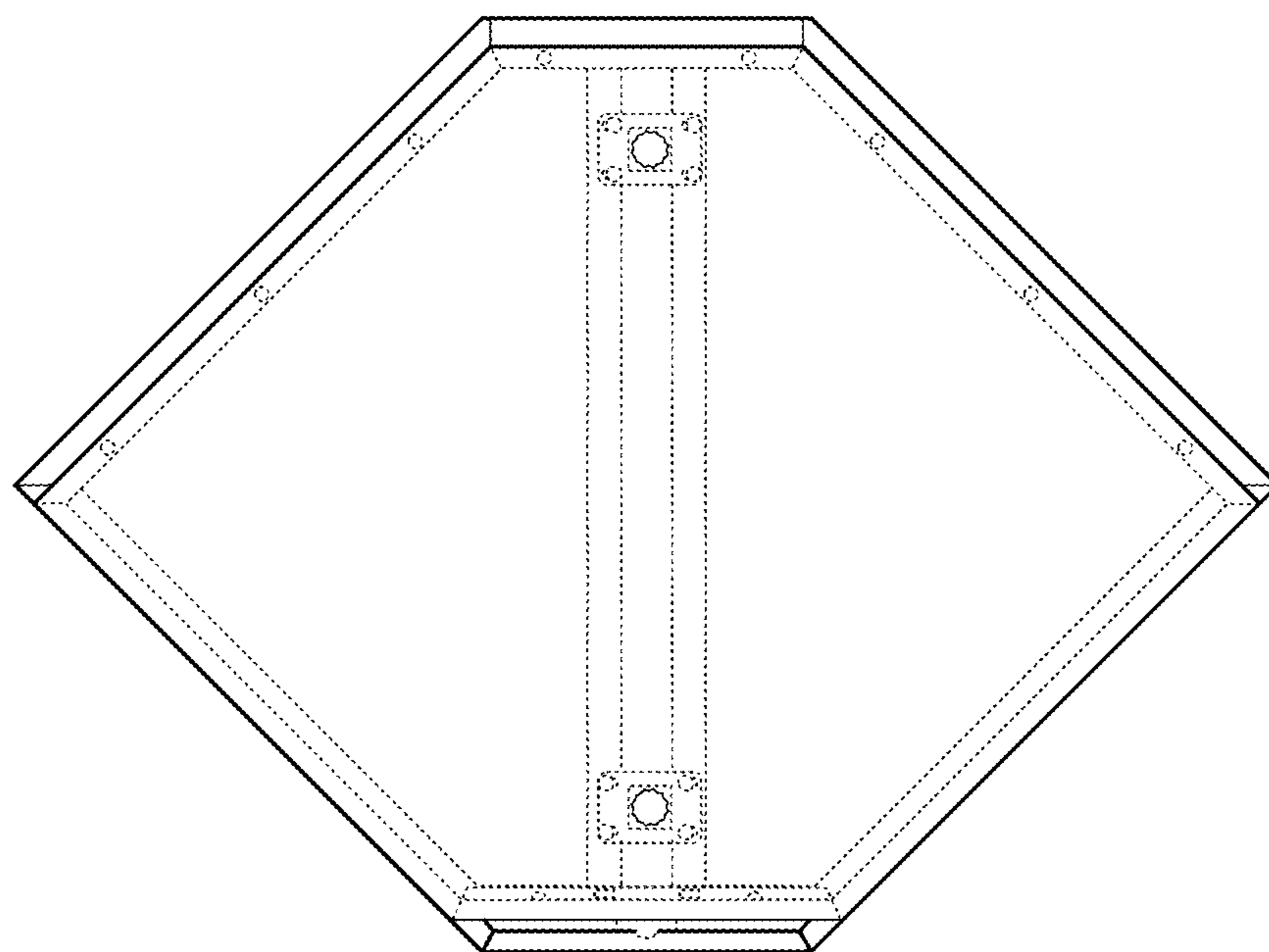

FIG. 8

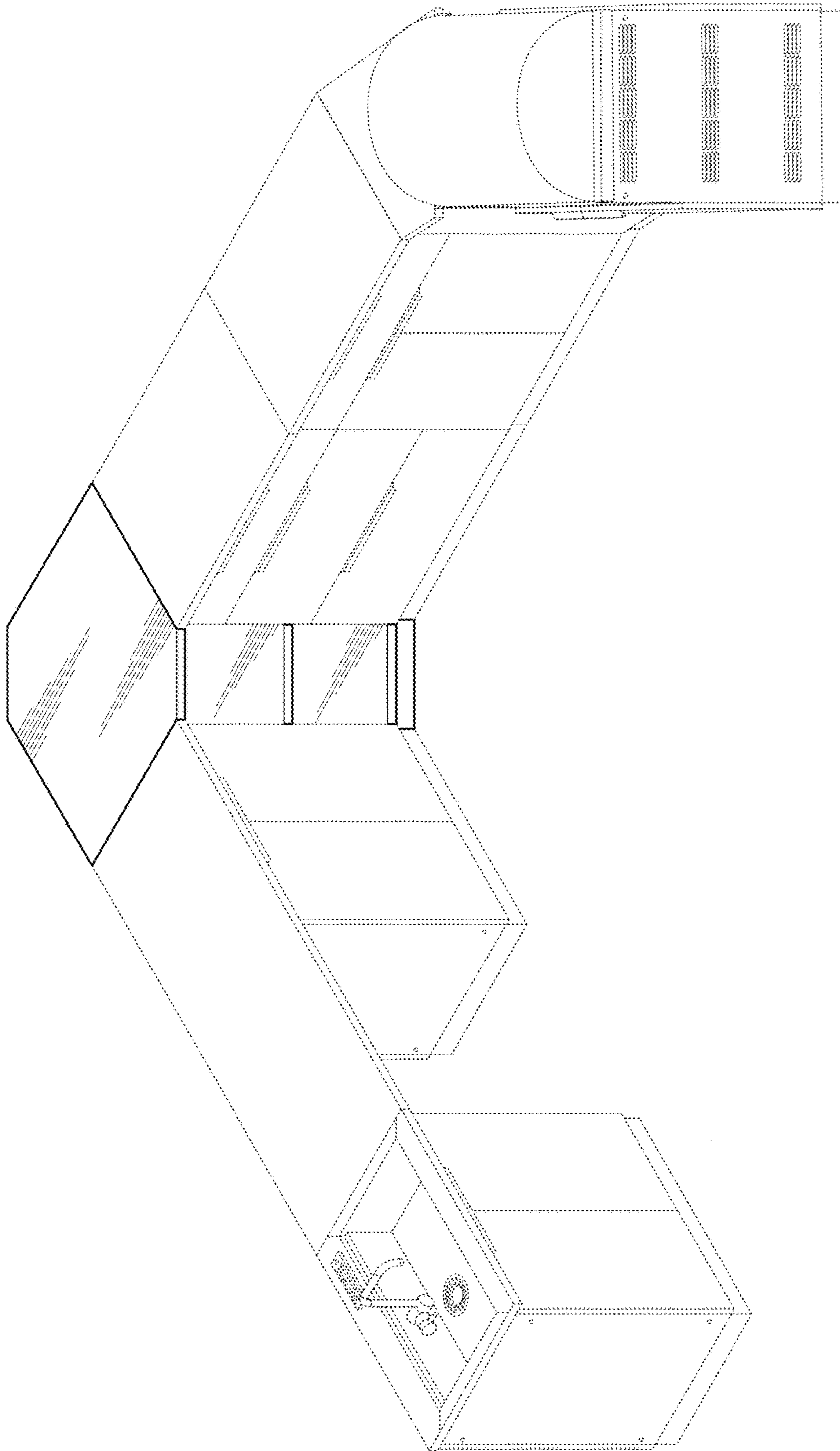

FIG. 9

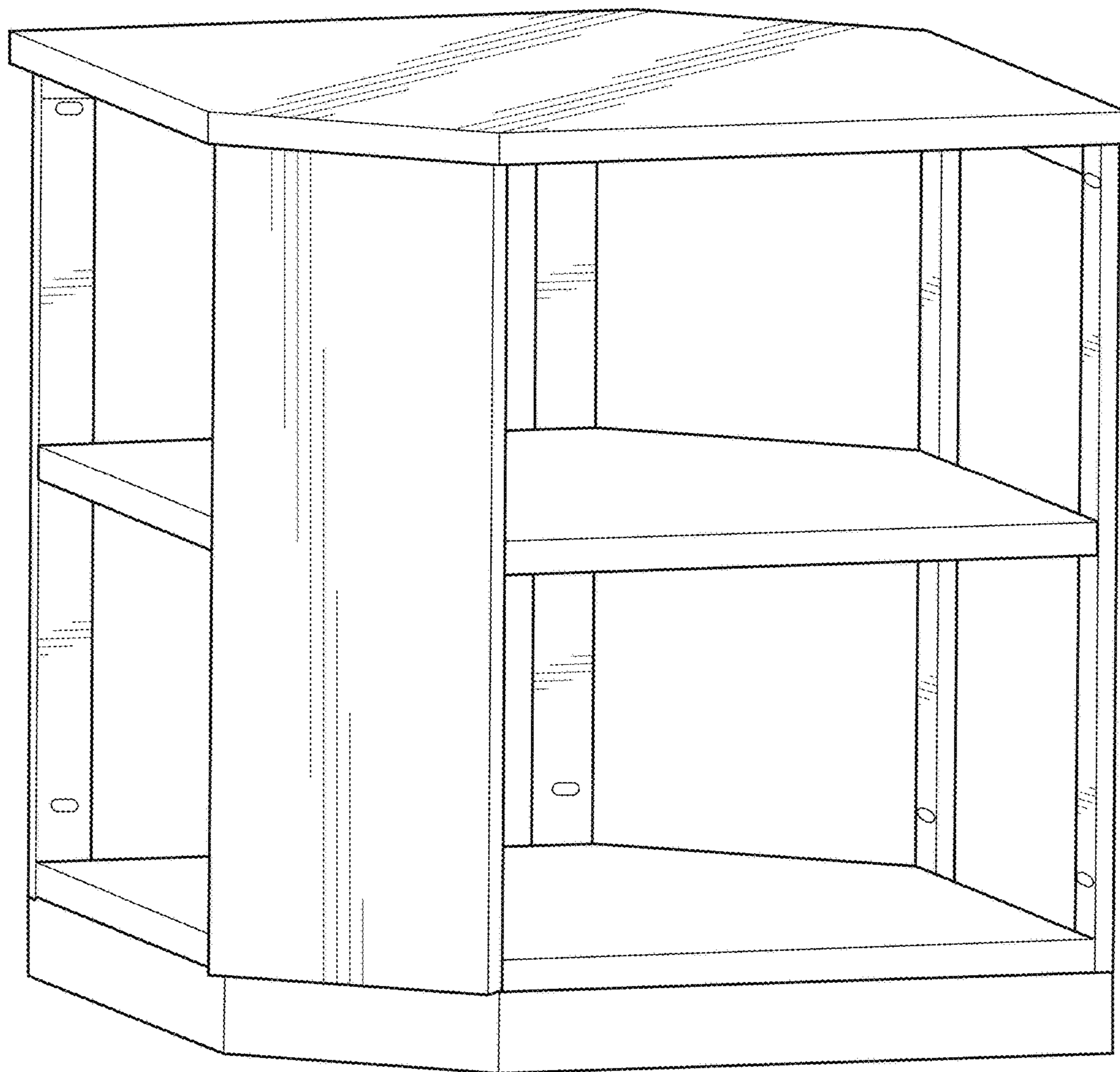

FIG. 10

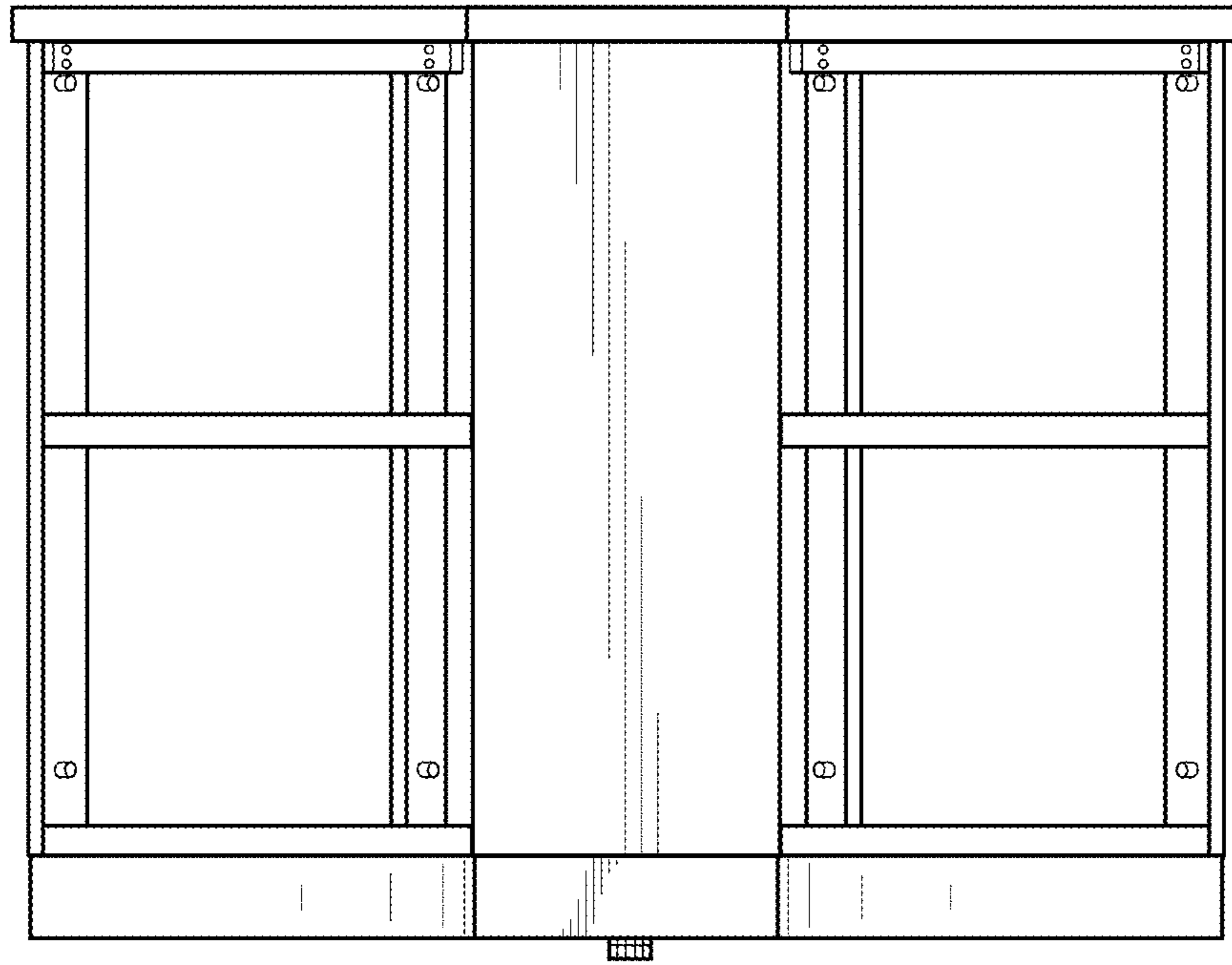

FIG. 11

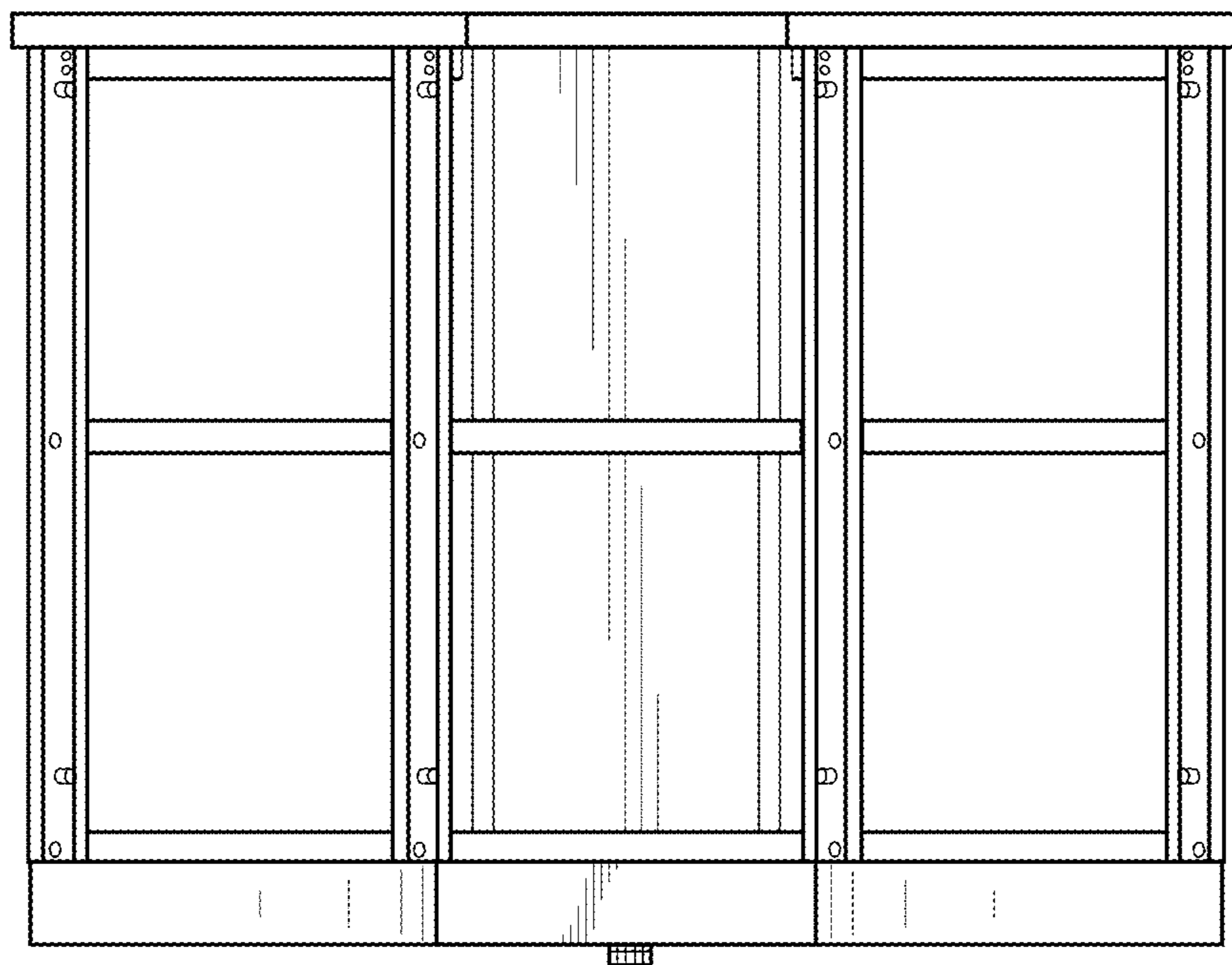

FIG. 12

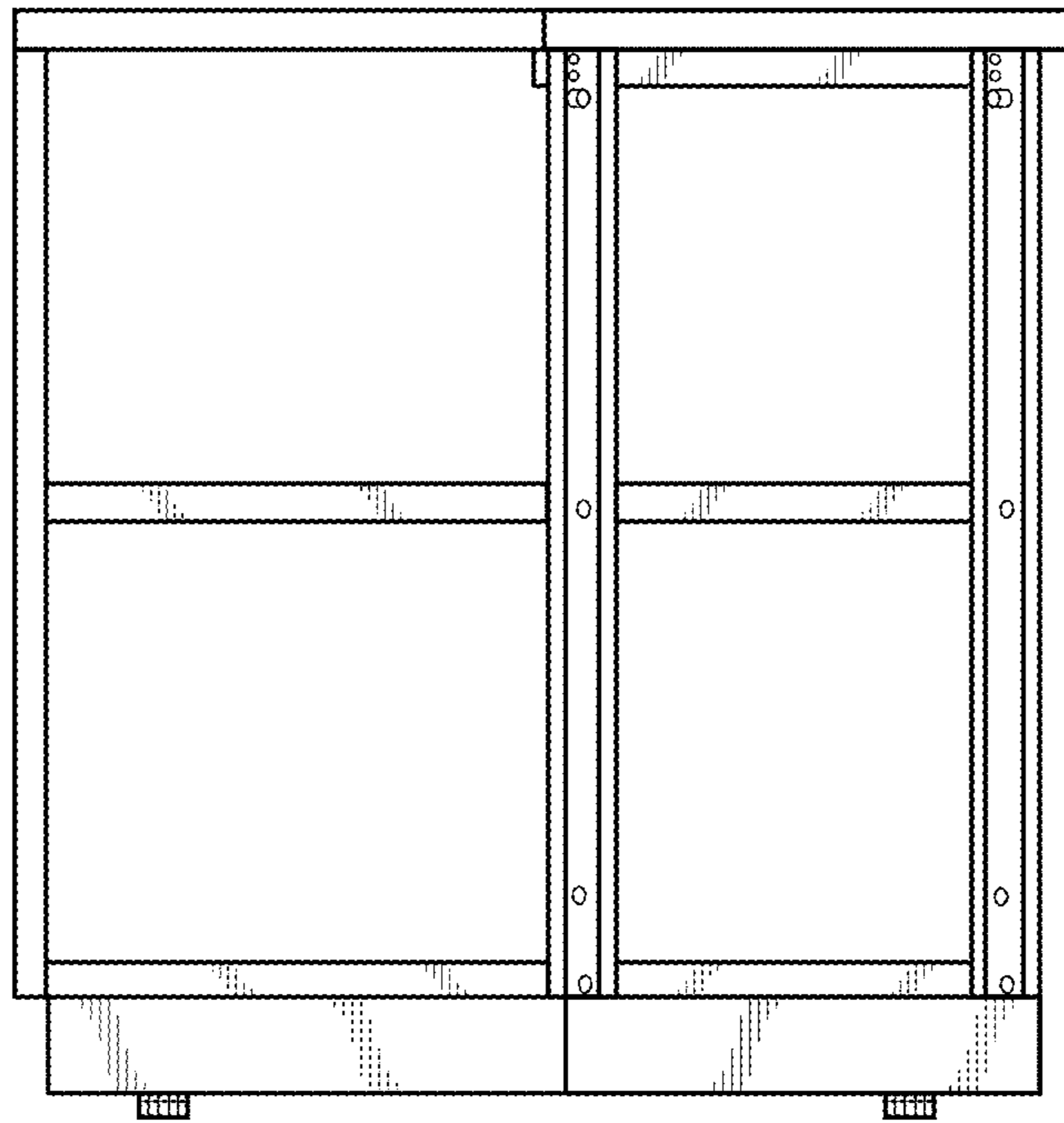

FIG. 13

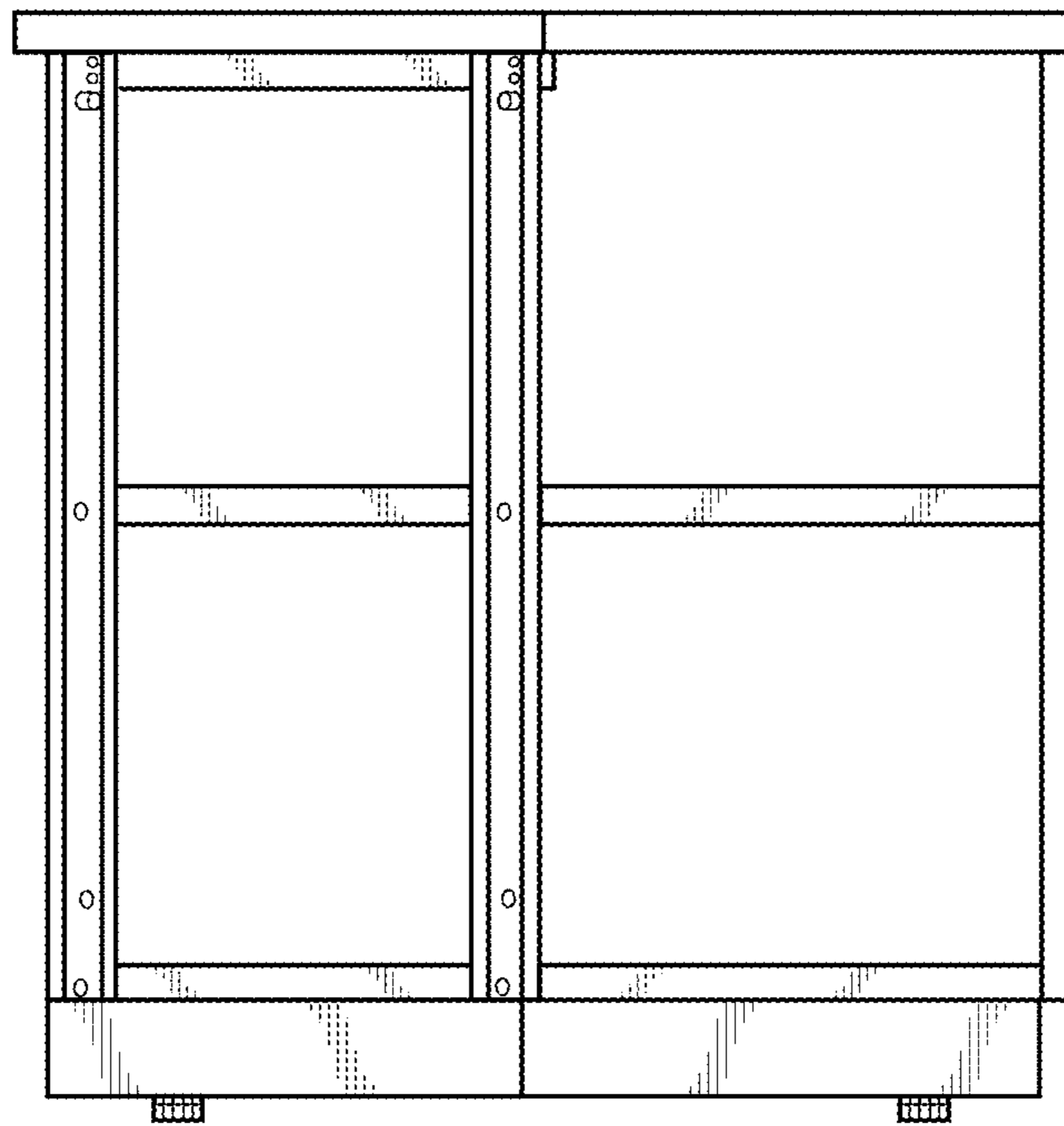

FIG. 14

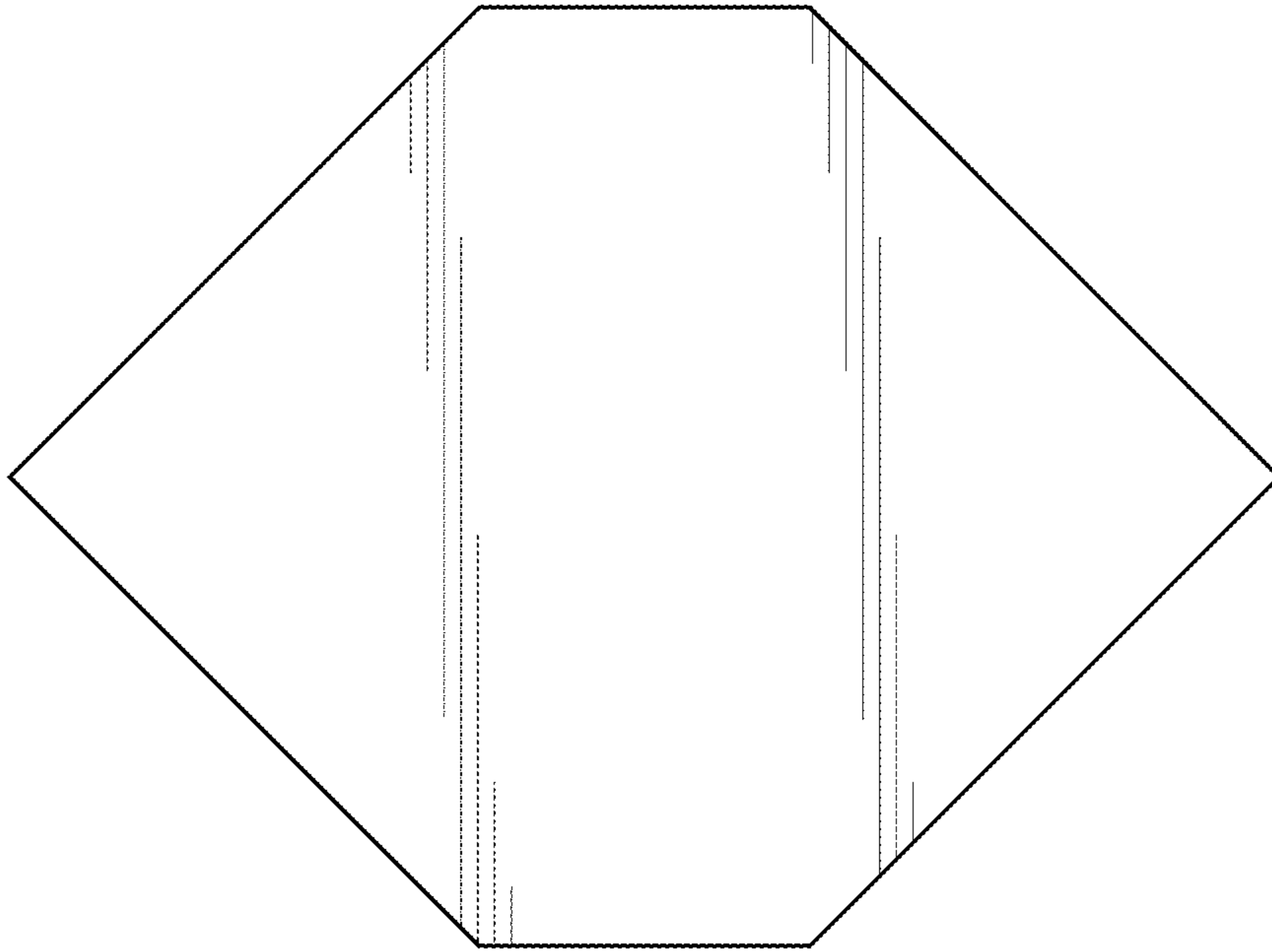

FIG. 15

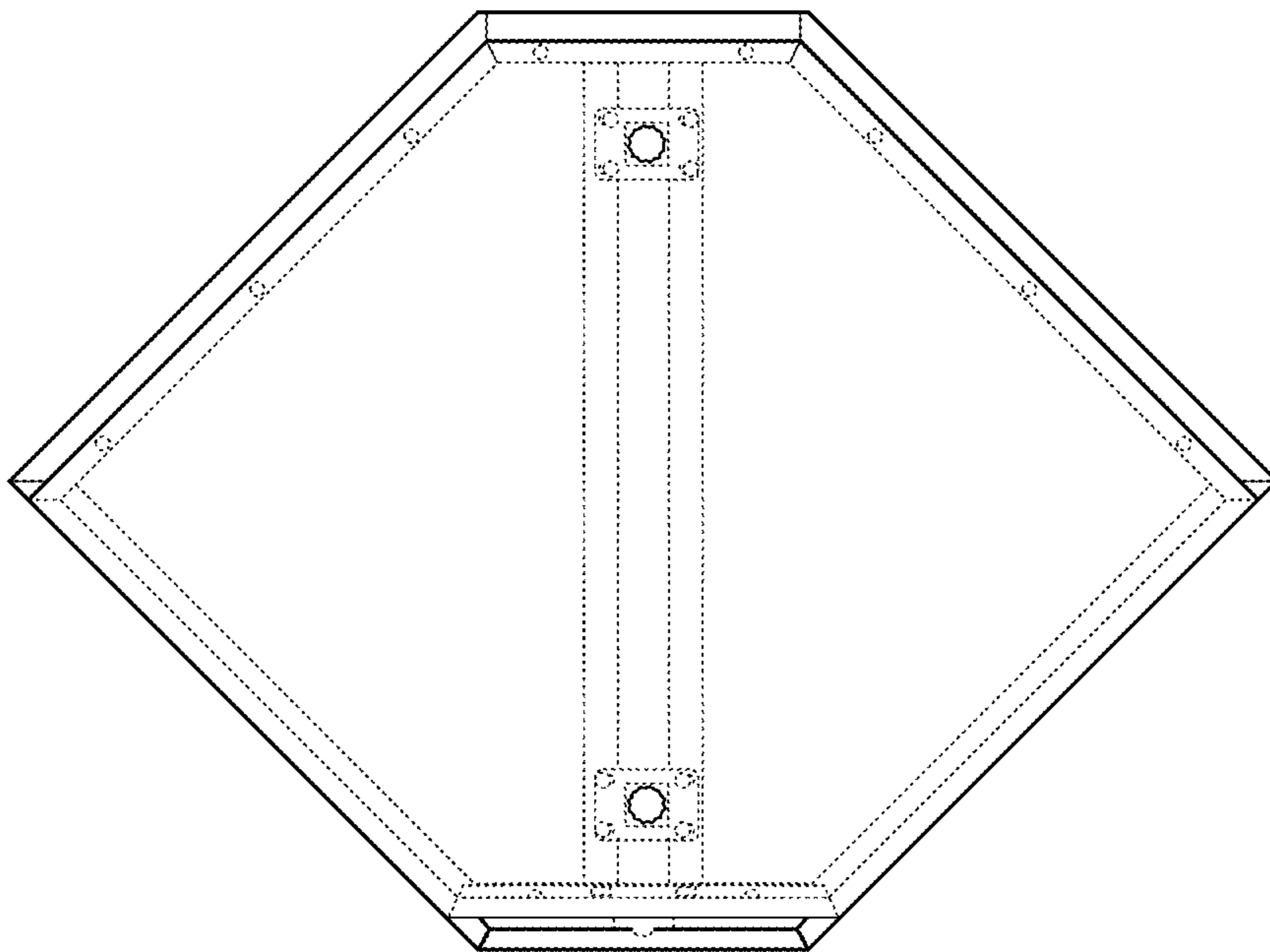

FIG. 16