



US00D837488S

(12) **United States Design Patent**  
**Noto et al.**

(10) **Patent No.:** **US D837,488 S**  
(45) **Date of Patent:** **\*\* Jan. 8, 2019**

- (54) **VERSATILE SKIRT / SHAWL**
- (71) Applicants: **Lisa Noto**, Montreal (CA); **Félicité Donyo**, Laval (CA)
- (72) Inventors: **Lisa Noto**, Montreal (CA); **Félicité Donyo**, Laval (CA)
- (\*\*) Term: **15 Years**
- (21) Appl. No.: **29/557,448**
- (22) Filed: **Mar. 9, 2016**
- (51) **LOC (11) Cl.** ..... **02-02**
- (52) **U.S. Cl.**  
USPC ..... **D2/851**
- (58) **Field of Classification Search**  
USPC ..... D2/824, 823, 826, 851  
See application file for complete search history.

(56) **References Cited**

U.S. PATENT DOCUMENTS

D25,190 S *	2/1896	Royce	.....	D2/851
2,421,934 A *	6/1947	Golfieri	.....	A41D 23/00
				2/204

(Continued)

OTHER PUBLICATIONS

“More skirts, shirts and shoes” posted by cotonblanc, Celine Ready to Wear, Shoes & Accessories, posted at purseforum, posting date Apr. 23, 2012 [online]. Available from Internet: < <https://forum.purseblog.com/threads/celine-ready-to-wear-shoes-accessories.746330/> >.\*

(Continued)

*Primary Examiner* — Kevin K Rudzinski

(57) **CLAIM**

The ornamental design for a versatile skirt/shawl, as shown and described.

**DESCRIPTION**

FIG. 1 is front perspective view of the versatile skirt/shawl in accordance with a first embodiment of the design;

FIG. 2 is a front side view of the versatile skirt/shawl of FIG. 1;

FIG. 3 is rear side view of the versatile skirt/shawl of FIG. 1, the front and rear sides shown being reversible, wherein the side shown in FIG. 1 is the rear side and the side shown in FIG. 3 is the front side;

FIG. 4 is a first lateral side view of the versatile skirt/shawl of FIG. 1;

FIG. 5 is a second lateral side view of the versatile skirt/shawl of FIG. 1 opposite the first side, wherein the first lateral side can be the left lateral side with the second lateral side being the right lateral side and wherein the first lateral side can be the right lateral side with the second side can be the left lateral side;

FIG. 6 is a top side view of the versatile skirt/shawl of FIG. 1;

FIG. 7 is a bottom side view of the versatile skirt/shawl of FIG. 1;

FIG. 8 is a front perspective view of the versatile skirt/shawl of FIG. 1 in its environment with the versatile skirt/shawl being worn by a user;

FIG. 9 is front perspective view of the versatile skirt/shawl in accordance with a second embodiment of the design;

FIG. 10 is a front side view of the versatile skirt/shawl of FIG. 9;

FIG. 11 is rear side view of the versatile skirt/shawl of FIG. 9, the front and rear sides shown being reversible, wherein the side shown in FIG. 9 is the rear side and the side shown in FIG. 10 is the front side;

FIG. 12 is a first lateral side view of the versatile skirt/shawl of FIG. 9;

FIG. 13 is an enlarged view of the circled portion of FIG. 12;

FIG. 14 is a second lateral side view of the shawl of FIG. 9 opposite the first side, wherein the first lateral side can be the left lateral side with the second lateral side being the right lateral side and wherein the first lateral side can be the right lateral side with the second side can be the left lateral side;

FIG. 15 is an enlarged view of the circled portion of FIG. 13;

FIG. 16 is a top side view of the versatile skirt/shawl of FIG. 9;

FIG. 17 is a bottom side view of the versatile skirt/shawl of FIG. 9; and,

(Continued)

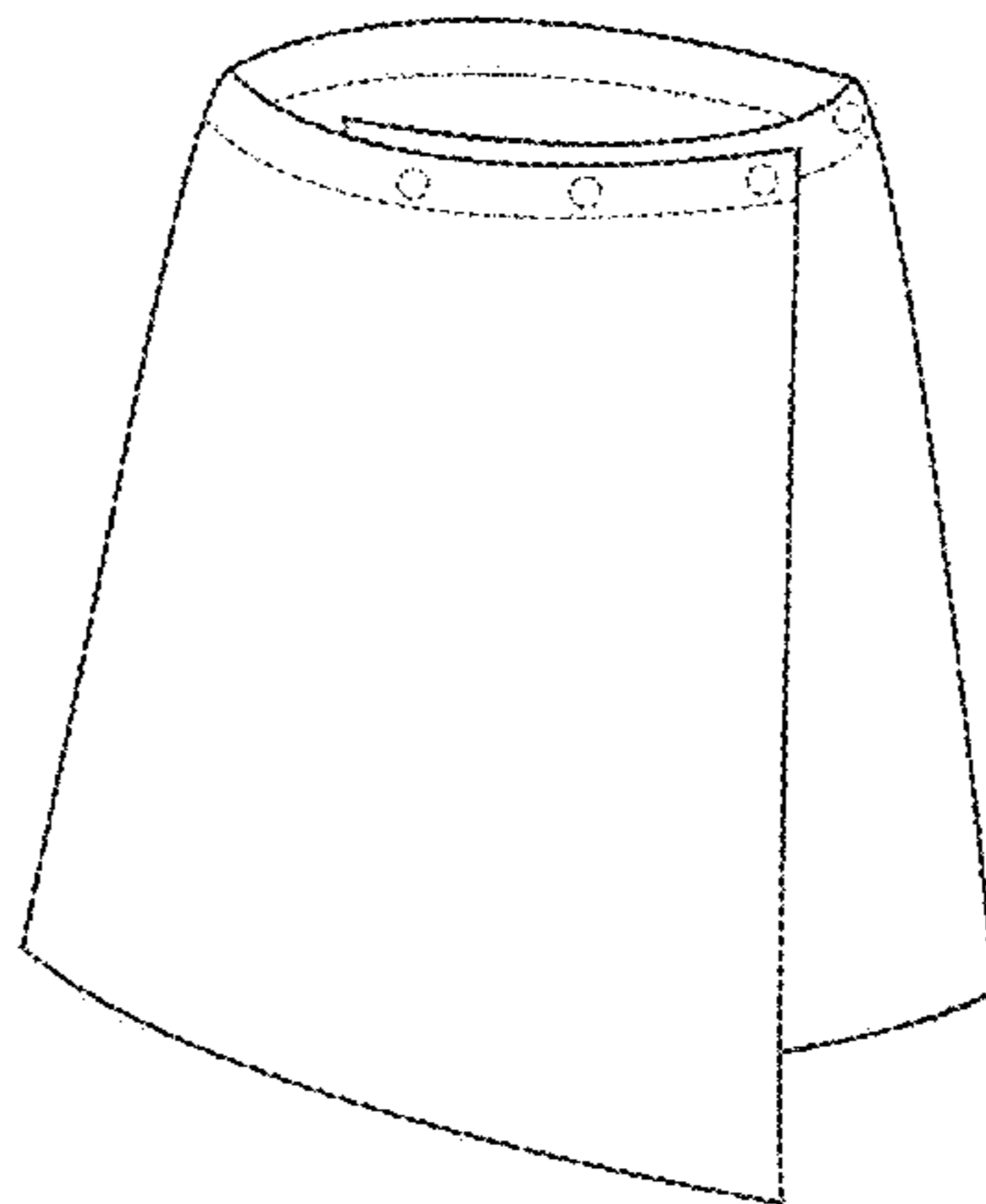


FIG. 18 is a front perspective view of the versatile skirt/shawl of FIG. 1 in its environment with the versatile skirt/shawl being worn by a user.

The broken lines shown on the versatile skirt/shawl form no part of the claimed design. The broken lines showing the figure of a user (wearer) are for the purpose of illustrating environment and form no part of the claimed design.

**1 Claim, 8 Drawing Sheets**

(56)

**References Cited**

U.S. PATENT DOCUMENTS

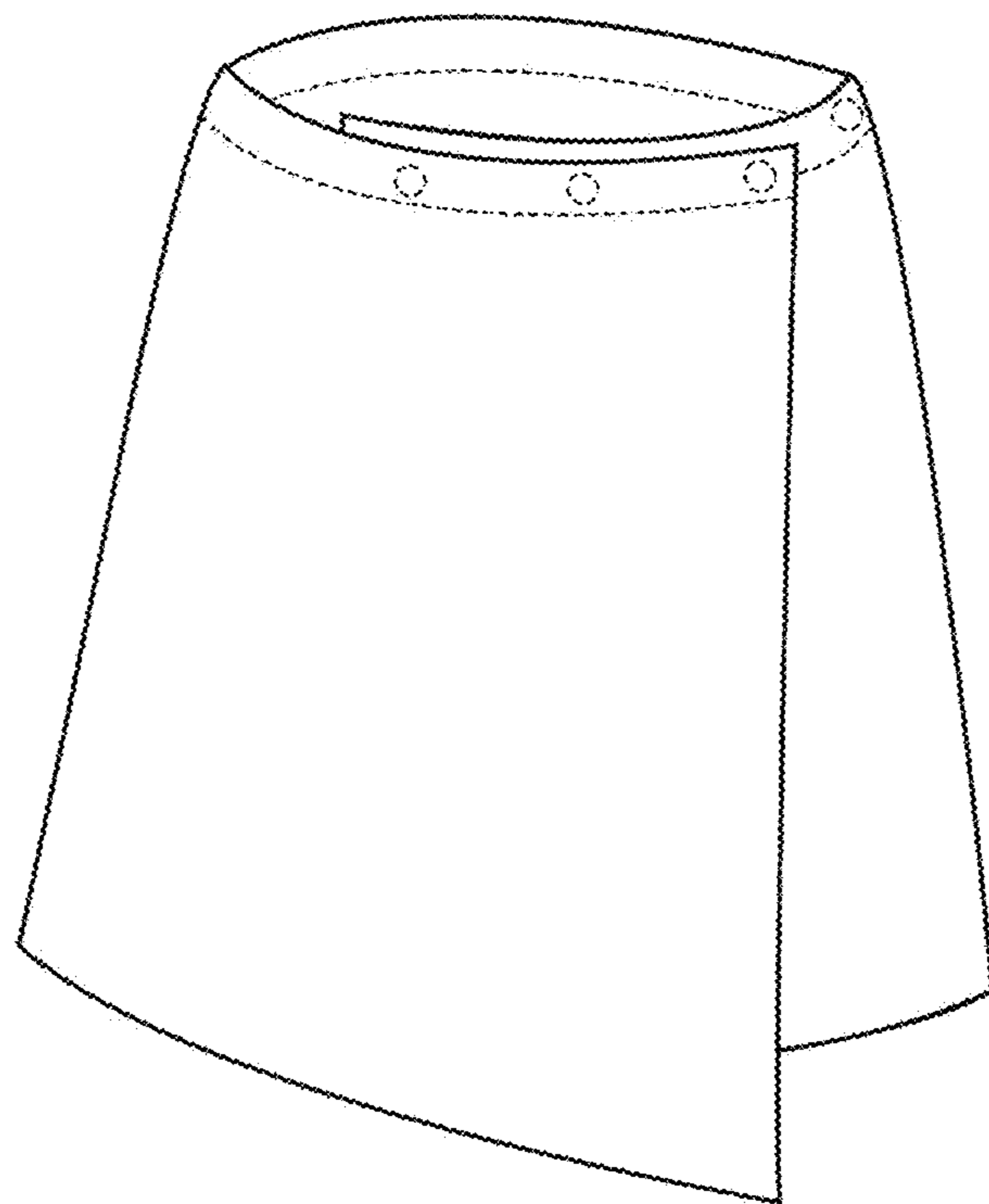
2,439,128 A \* 4/1948 De Oliensis ..... A41D 1/22  
2/74  
2,674,738 A \* 4/1954 Mehlos ..... A41D 1/205  
2/48  
2,912,698 A \* 11/1959 Greenblatt ..... A41D 15/005  
2/211  
2,985,887 A \* 5/1961 Lindley ..... A41D 1/14  
2/211  
3,160,892 A \* 12/1964 Semons ..... A41D 7/008  
2/88  
3,490,449 A \* 1/1970 Ewehvahn ..... A41F 1/04  
2/265

D232,604 S \* 9/1974 Kadison ..... 2/219  
D300,480 S \* 4/1989 Seymore ..... D2/851  
D396,543 S \* 8/1998 Owen ..... D2/728  
6,175,964 B1 \* 1/2001 Adler ..... A41D 15/00  
2/207  
6,986,163 B2 \* 1/2006 Dugan ..... A41B 13/06  
2/48  
D592,830 S \* 5/2009 Whiteside ..... D2/728  
D622,936 S \* 9/2010 Baker ..... D2/826  
D654,247 S \* 2/2012 Osbourne ..... D2/702  
9,015,867 B2 \* 4/2015 Kenney ..... A41D 15/02  
2/227  
D746,025 S \* 12/2015 Costanzo ..... D2/851  
D756,070 S \* 5/2016 Hershey ..... D2/851  
D792,679 S \* 7/2017 Gamble ..... D2/826

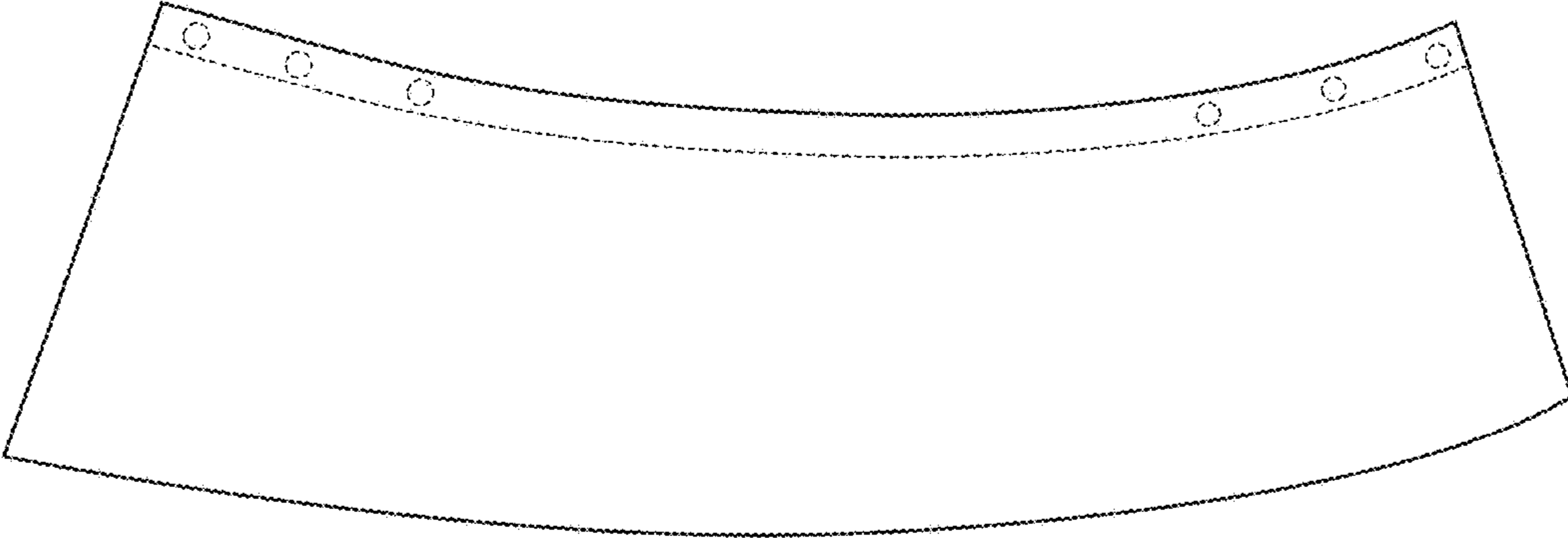
OTHER PUBLICATIONS

Workwear: Black Wrap Skirt, posted at [symphonyofsilk](http://www.symphonyofsilk.com/2015/08/workwear-black-wrap-skirt/), posting date Aug. 14, 2015, Available from Internet: < <http://www.symphonyofsilk.com/2015/08/workwear-black-wrap-skirt/> >.\*  
Sewing on Trend: The Asymmetrical Pencil Skirt, posted at [truebias](http://truebias.com/2013/12/sewing-on-trend-asymmetrical-pencil.html), posting date Dec. 10, 2013. Available from Internet: < <http://truebias.com/2013/12/sewing-on-trend-asymmetrical-pencil.html> >.\*  
Before & After: The Asymmetric-Hem Mini Skirt, posted at [apairandasparediy](http://apairandasparediy.com/2012/03/before-after-the-asymmetric-hem-mini-skirt/), posting date Mar. 19, 2012. Available from Internet: < <http://apairandasparediy.com/2012/03/before-after-the-asymmetric-hem-mini-skirt/> >.\*

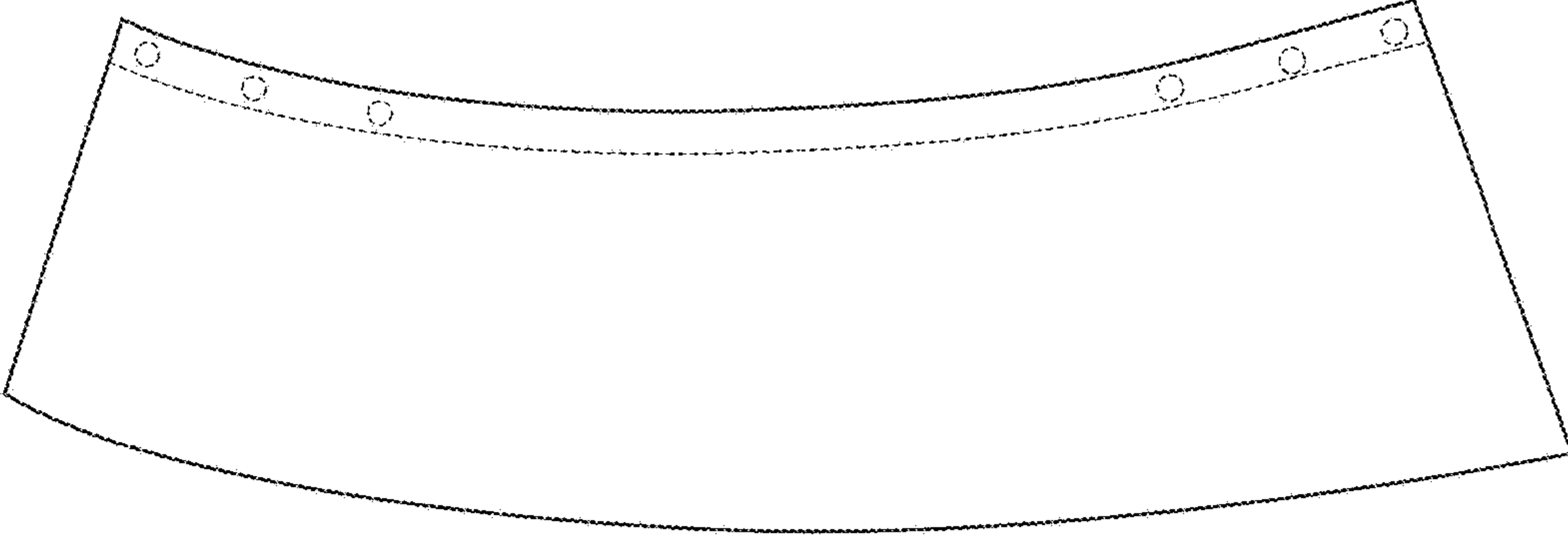
\* cited by examiner



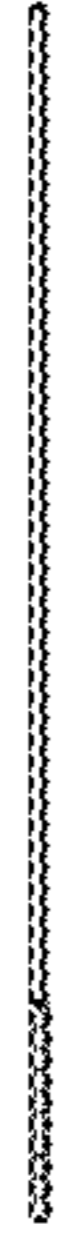
**FIG. 1**



**FIG. 2**



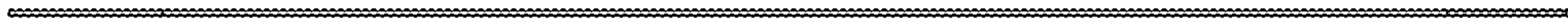
**FIG. 3**



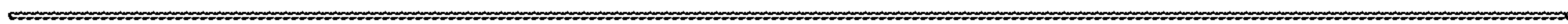
**FIG. 4**



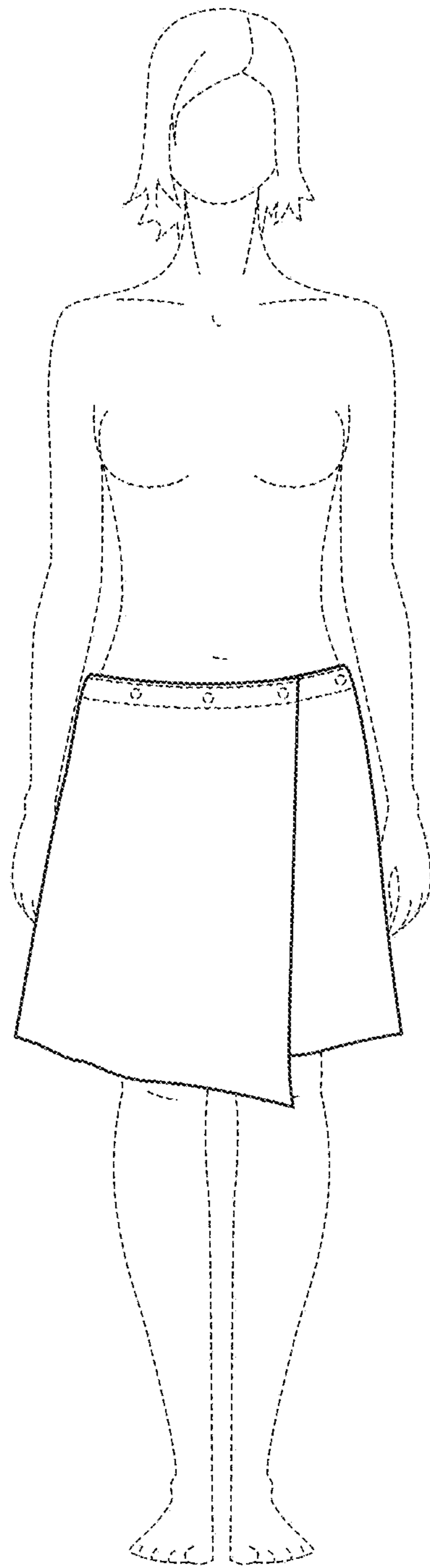
**FIG.5**



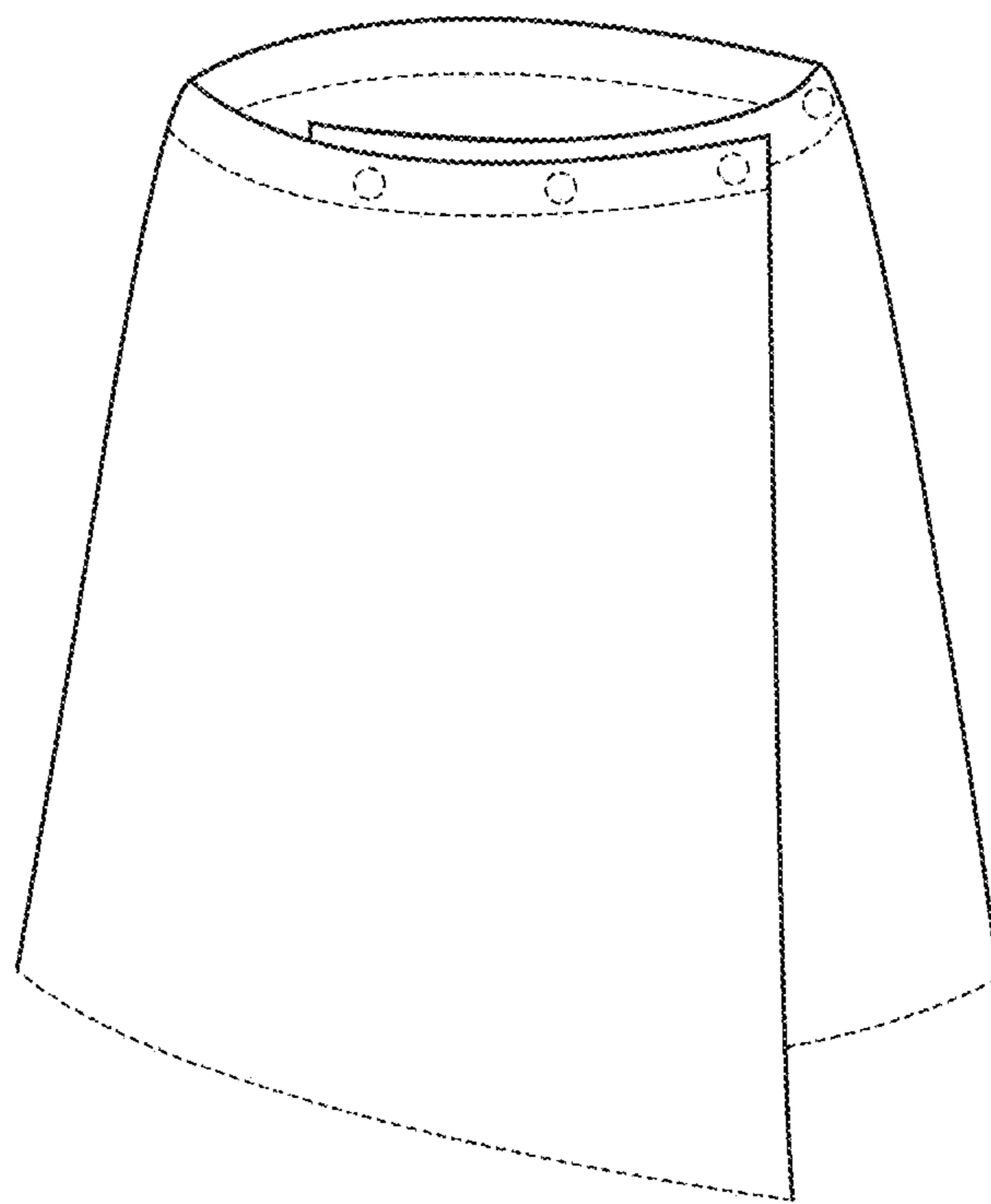
**FIG. 6**



**FIG. 7**



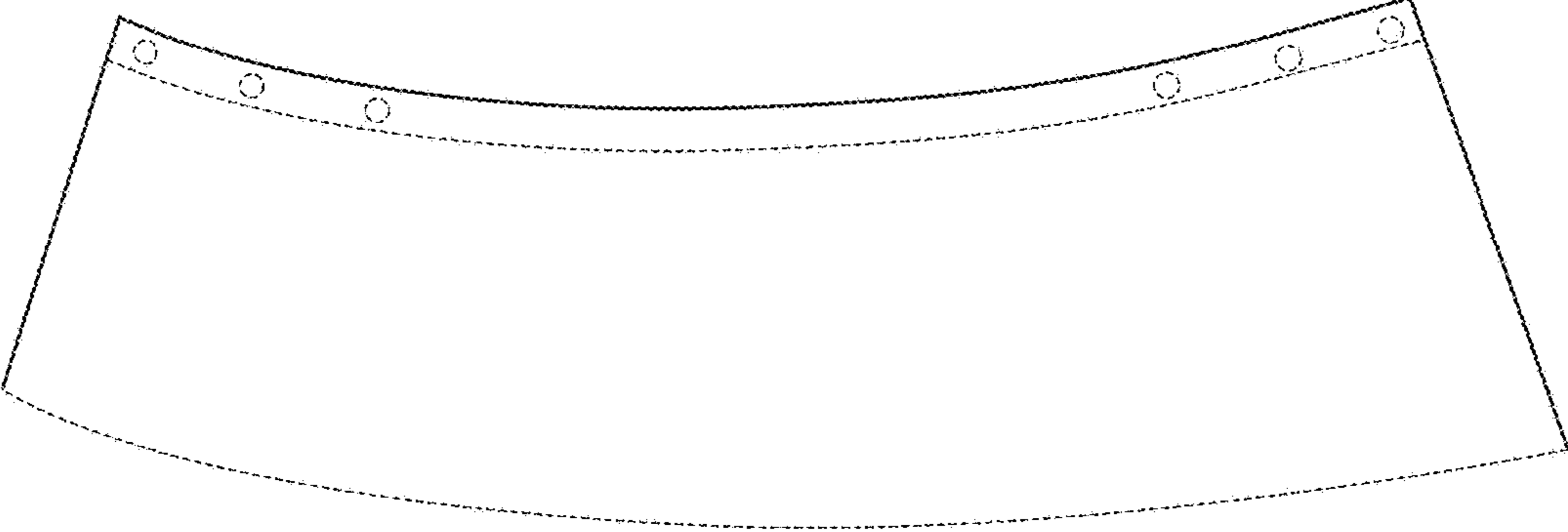
**FIG. 8**



**FIG. 9**

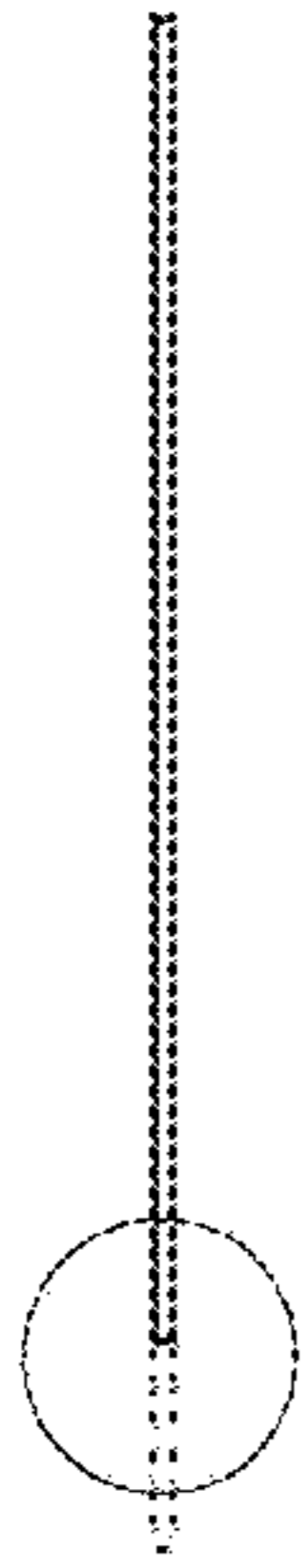


**FIG. 10**

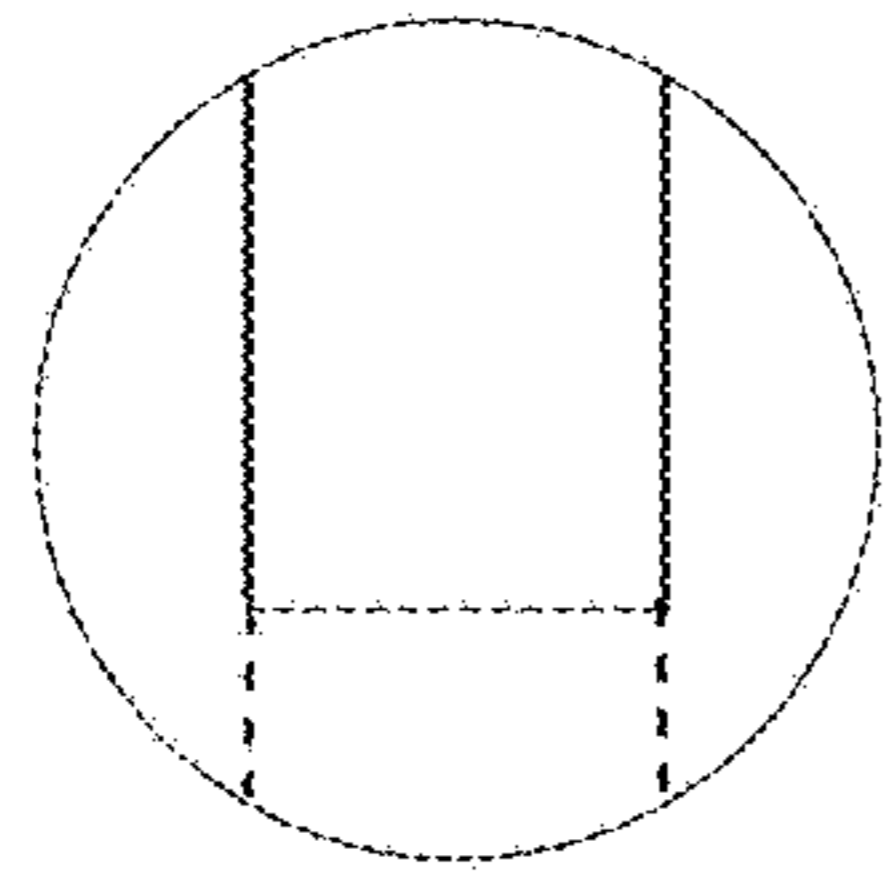


**FIG. 11**

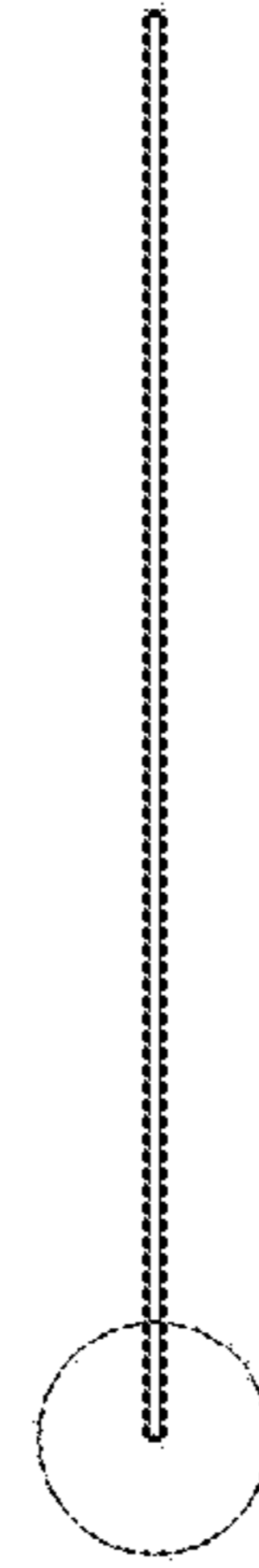




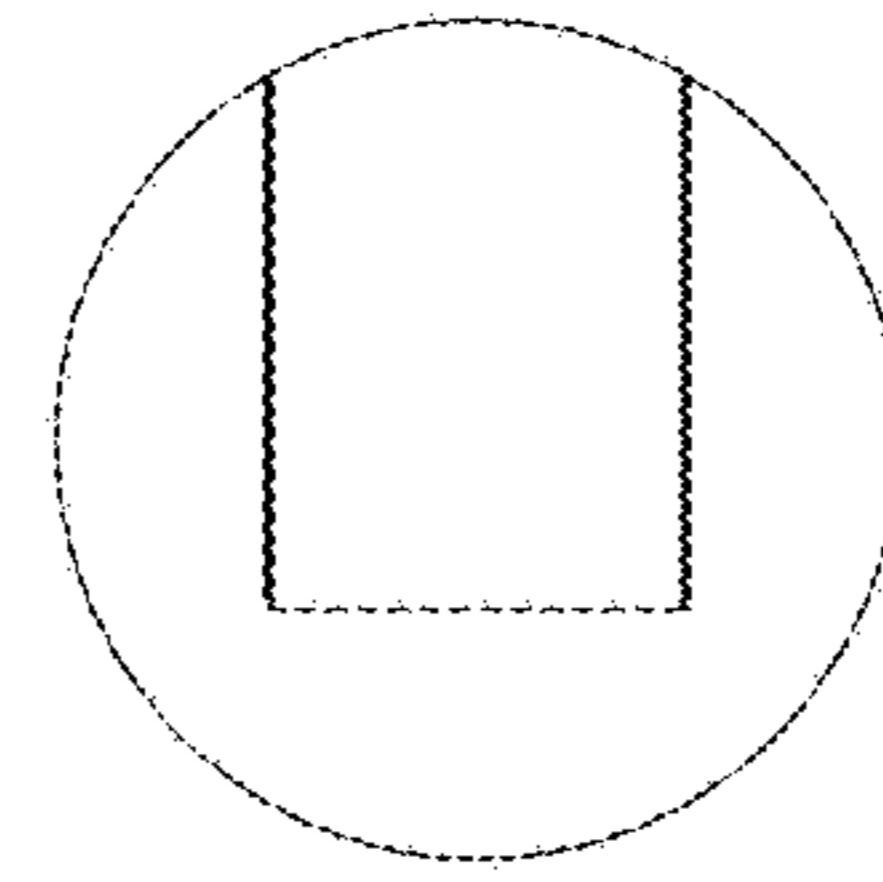
**FIG. 12**



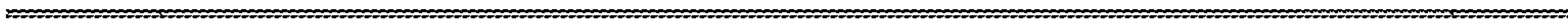
**FIG. 13**



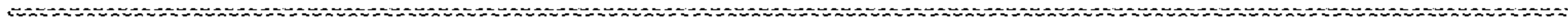
**FIG. 14**



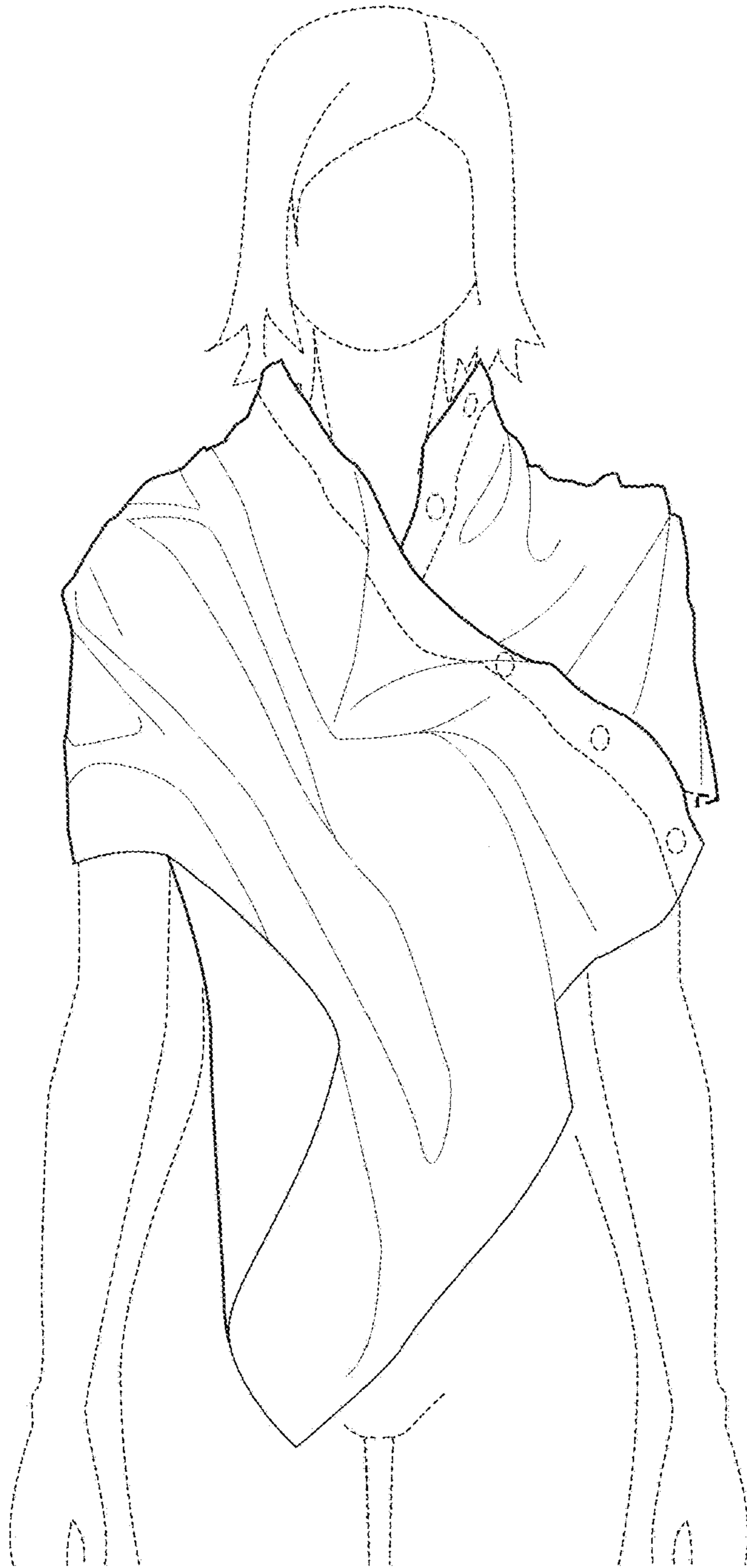
**FIG. 15**



**FIG. 16**



**FIG. 17**



**FIG. 18**