



US00D837472S

(12) **United States Design Patent** (10) **Patent No.:** **US D837,472 S**
Ring et al. (45) **Date of Patent:** **** Jan. 1, 2019**

(54) **CLEANING PADS**

(71) Applicant: **Ringbrothers, LLC**, Spring Green, WI (US)

(72) Inventors: **James Alan Ring**, Spring Green, WI (US); **Michael Daniel Ring**, Spring Green, WI (US); **Matthew Edward Moseman**, Sauk City, WI (US)

(73) Assignee: **Ringbrothers LLC**, Spring Green, WI (US)

(**) Term: **15 Years**

(21) Appl. No.: **29/581,289**

(22) Filed: **Oct. 18, 2016**

(51) **LOC (11) Cl.** **07-05**

(52) **U.S. Cl.**
USPC **D32/40**

(58) **Field of Classification Search**
USPC D32/40, 43; D28/7
See application file for complete search history.

(56) **References Cited**

U.S. PATENT DOCUMENTS

450,378 A * 4/1891 Robinson B24D 15/00
15/245
574,449 A * 1/1897 Pritschau B24D 3/24
15/244.3

(Continued)

FOREIGN PATENT DOCUMENTS

KR 300658734.0000 * 9/2012

OTHER PUBLICATIONS

Auto Detailing Tools—Detail King, website 2018, <http://www.detailking.com/store-home/auto-detailing-tools/>, site visited Jan. 30, 2018.*

(Continued)

Primary Examiner — John Windmuller

Assistant Examiner — John R Yeh

(74) *Attorney, Agent, or Firm* — Fitch, Even, Tabin & Flannery LLP

(57) **CLAIM**

We claim the ornamental design for cleaning pads, as shown and described.

DESCRIPTION

FIG. 1 is a front-top perspective view for our design for a cleaning pad;
FIG. 2 is a bottom perspective thereof;
FIG. 3 is a right side view thereof;
FIG. 4 is a left side view thereof;
FIG. 5 is a front elevation view thereof;
FIG. 6 is a rear elevation view thereof;
FIG. 7 is a bottom view thereof;
FIG. 8 is a top view thereof;
FIG. 9 is a front-top perspective view for a second design for a cleaning pad;
FIG. 10 is a bottom perspective view thereof;
FIG. 11 is a right side view thereof;
FIG. 12 is a left side view thereof;
FIG. 13 is a front elevation view thereof;
FIG. 14 is a rear elevation view thereof;
FIG. 15 is a bottom view thereof;
FIG. 16 is a top view thereof;
FIG. 17 is a top front perspective view for a third design for a cleaning pad;
FIG. 18 is a right side view thereof;
FIG. 19 is a left side view thereof;
FIG. 20 is a front elevation view thereof;
FIG. 21 is a rear elevation view thereof;
FIG. 22 is a bottom view thereof; and,
FIG. 23 is a top view thereof.
The cleaning pad is shown broken away in the middle in FIGS. 17-23 to indicate that it has no particular length beyond what is shown.

1 Claim, 20 Drawing Sheets

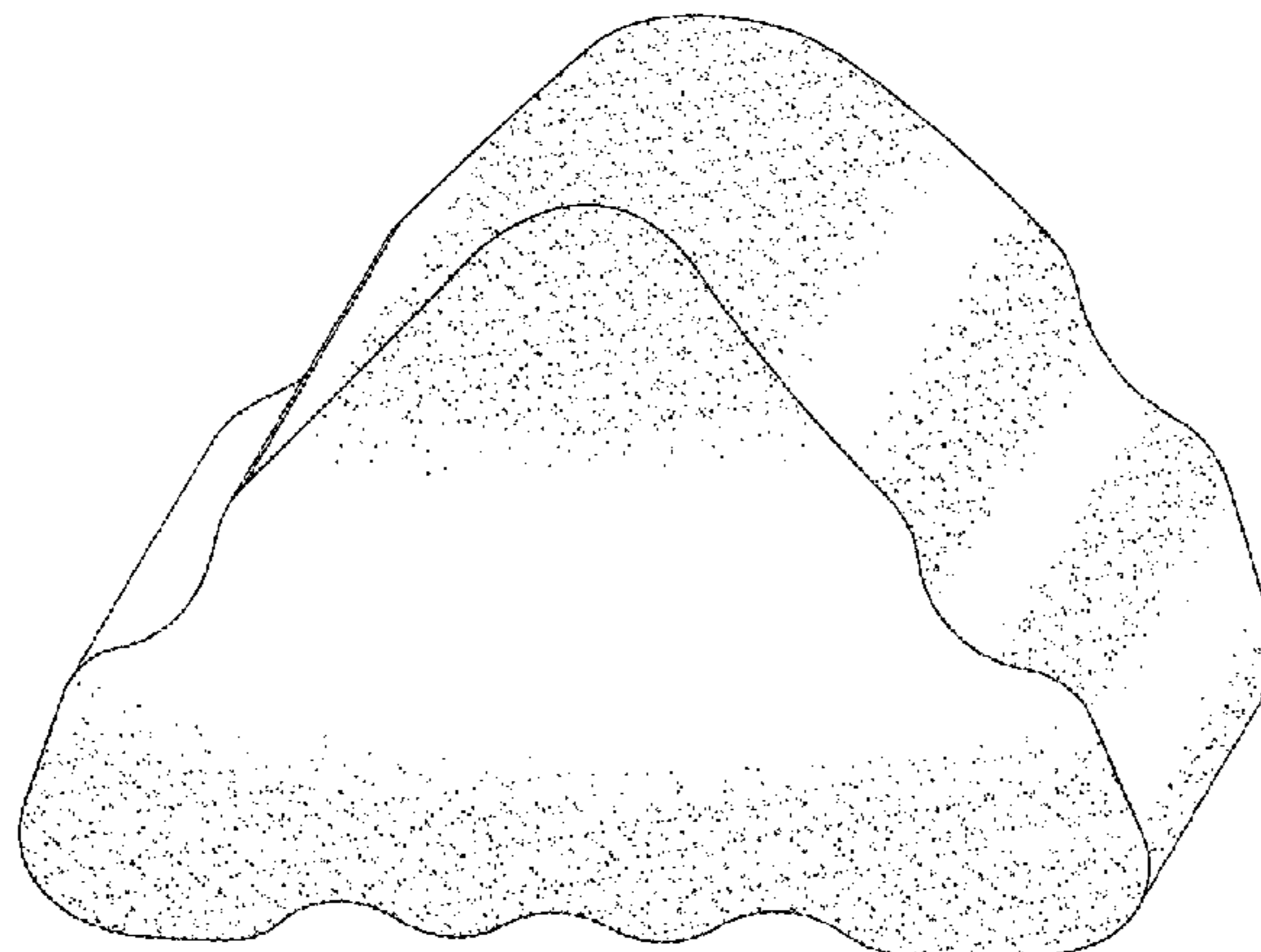

(56)

References Cited

U.S. PATENT DOCUMENTS

D30,072 S * 1/1899 Thomas D25/138
 D226,595 S * 4/1973 Caunes D1/121
 4,120,068 A 10/1978 Kaczmarek
 D271,817 S * 12/1983 Collin D32/40
 4,524,480 A 6/1985 Bloom
 D291,258 S * 8/1987 Greer, Sr. D32/40
 4,727,619 A 3/1988 Robbins
 4,903,364 A 2/1990 Long
 5,123,136 A 6/1992 Belanger
 D355,105 S * 2/1995 Nemazi D32/40
 5,449,303 A 9/1995 McLeod
 5,806,128 A 9/1998 Love
 5,991,952 A 11/1999 Bintzler
 6,067,686 A 5/2000 Gronkiewicz
 6,240,592 B1 6/2001 Li
 6,470,526 B2 10/2002 Large
 D525,403 S * 7/2006 Olsson D32/40
 D527,974 S * 9/2006 Petersen D8/90
 D532,583 S * 11/2006 Townsend D1/122
 D552,814 S * 10/2007 Munro D32/40
 7,356,867 B1 4/2008 Beiermann
 D585,177 S * 1/2009 Wylie D1/125
 D588,766 S * 3/2009 Dunshee D32/40
 D590,555 S * 4/2009 Dunshee D32/40
 D593,277 S * 6/2009 Wylie D1/199
 D602,665 S * 10/2009 Porcini D32/40
 D610,321 S * 2/2010 Leahy D32/40

D659,837 S * 5/2012 Oien D24/177
 D663,084 S * 7/2012 Pedriza Hernandez D32/40
 8,365,338 B1 2/2013 Figaro
 D689,190 S * 9/2013 Oien D24/176
 D708,806 S * 7/2014 Nagoya D32/40
 D766,509 S * 9/2016 Nicoline D28/63
 D771,348 S * 11/2016 Traynor D1/128
 D805,728 S * 12/2017 Belt D1/199
 2007/0177931 A1 8/2007 Hodges
 2008/0047085 A1 2/2008 Kolarevic
 2011/0229843 A1* 9/2011 Oien A61C 5/025
 433/77

OTHER PUBLICATIONS

Scotch-Brite(TM) Durable Flex Hand Pad—Ringbrothers website 2018, <https://ringbrothers.com/scotch-brite-tm-durable-flex-hand-pad-64660.html>, site visited Jan. 30, 2018.*
 Power Products website Mothers® Powerball®; retrieved on Oct. 20, 2015; http://www.mothers.com/02_products/05140.html#&slider1=3; 1 page.
 Amazon.com: wheel cleaner website retrieved on Oct. 20, 2015; 6 pages.
 Autogeek website “Recessed Wheel Lug Nut Brush Replacement Foam Inserts, Replacement Lug Nut Brush Heads”; retrieved on Oct. 20, 2015; <http://www.autogeek.net/wheel-lug-nut-brush-inserts.html>; 2 pages.

* cited by examiner

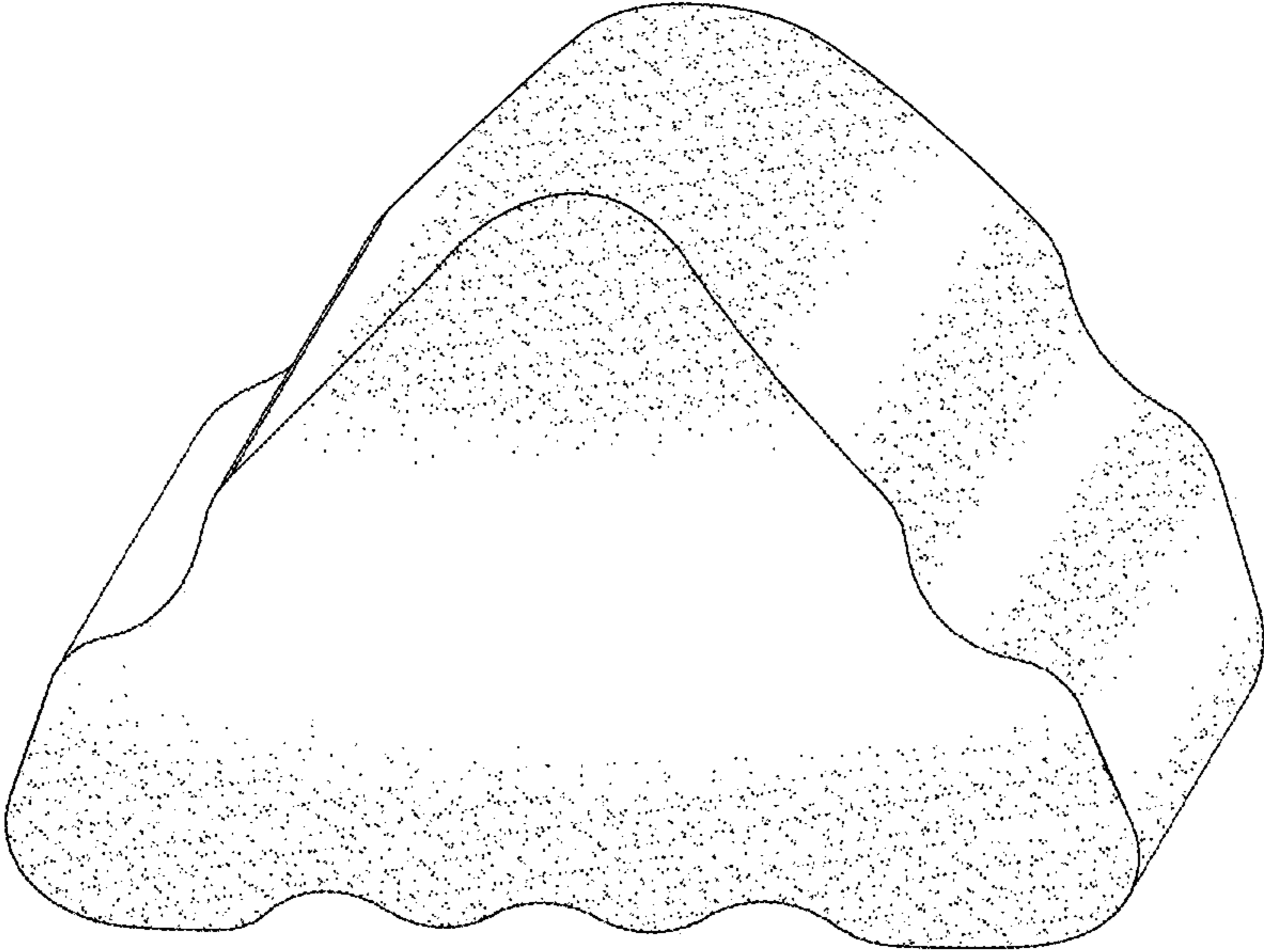

FIG. 1

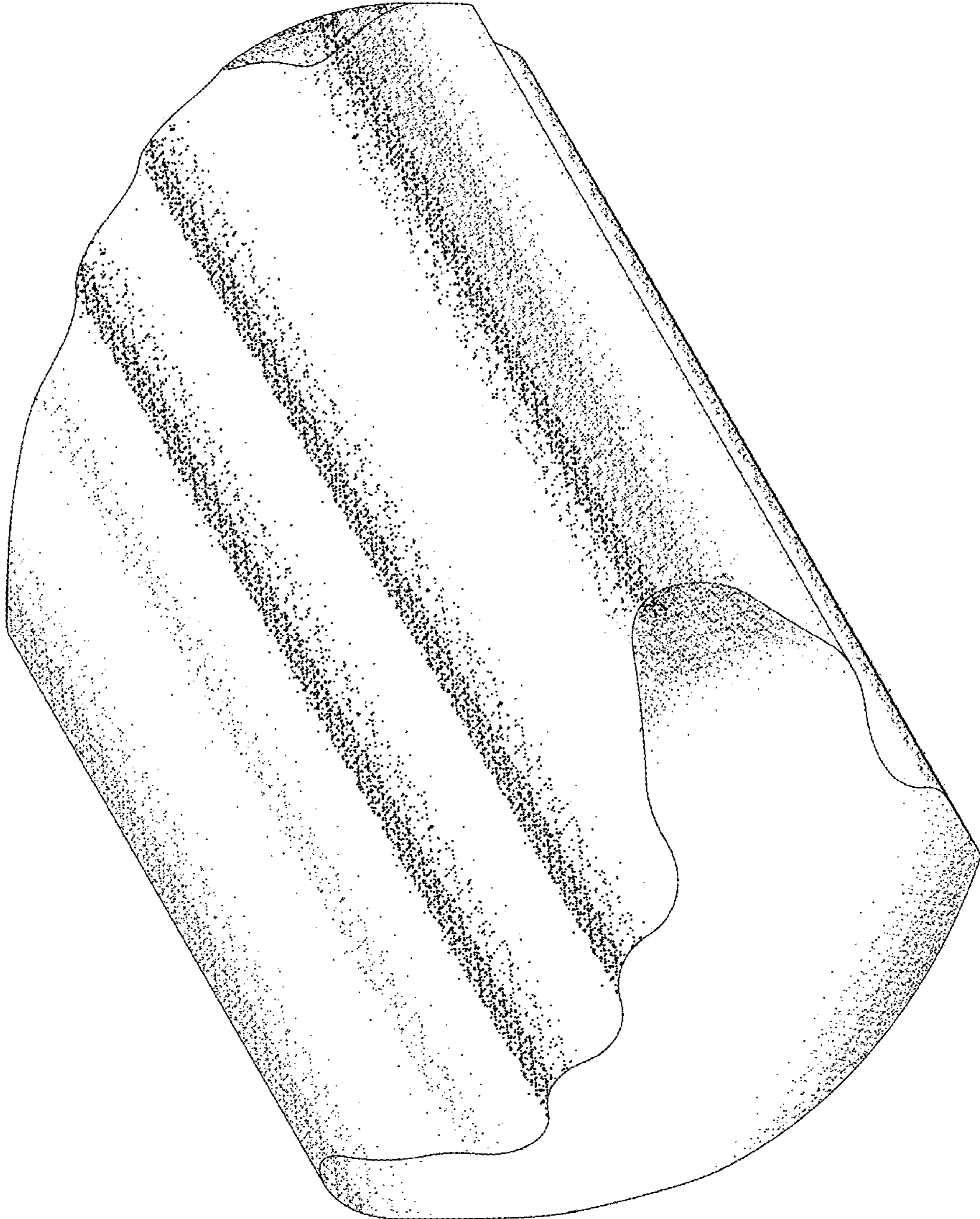

FIG. 2

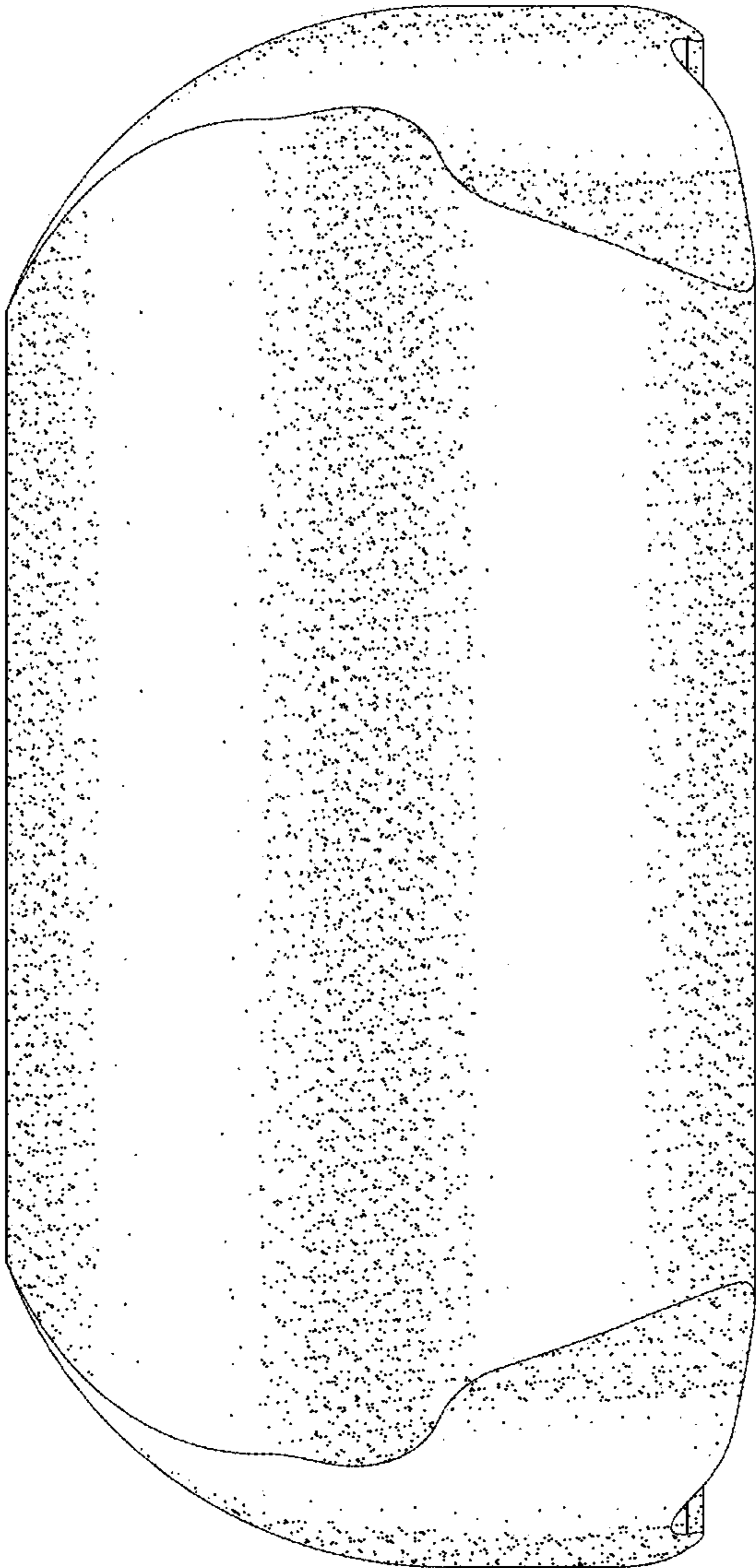

FIG. 3

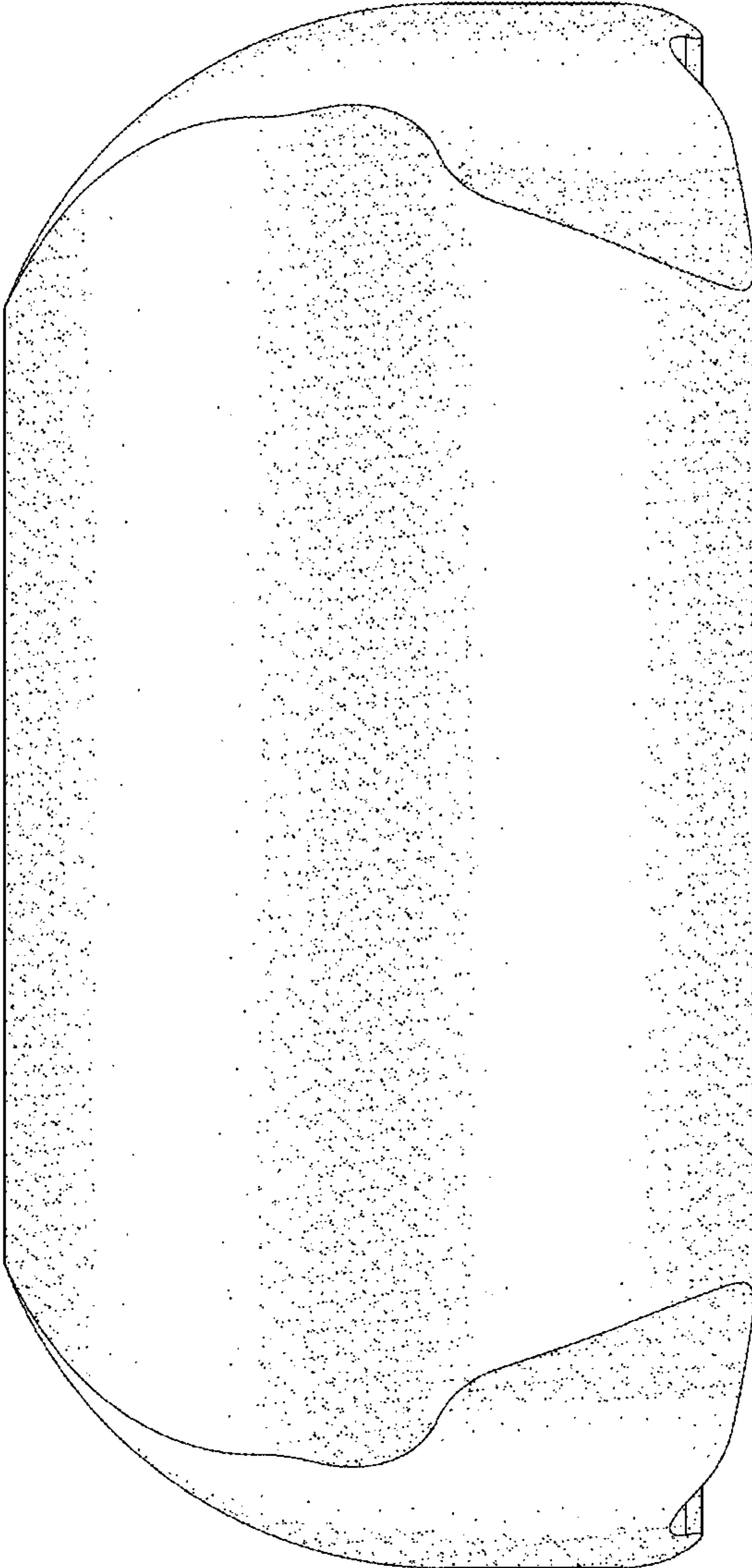

FIG. 4

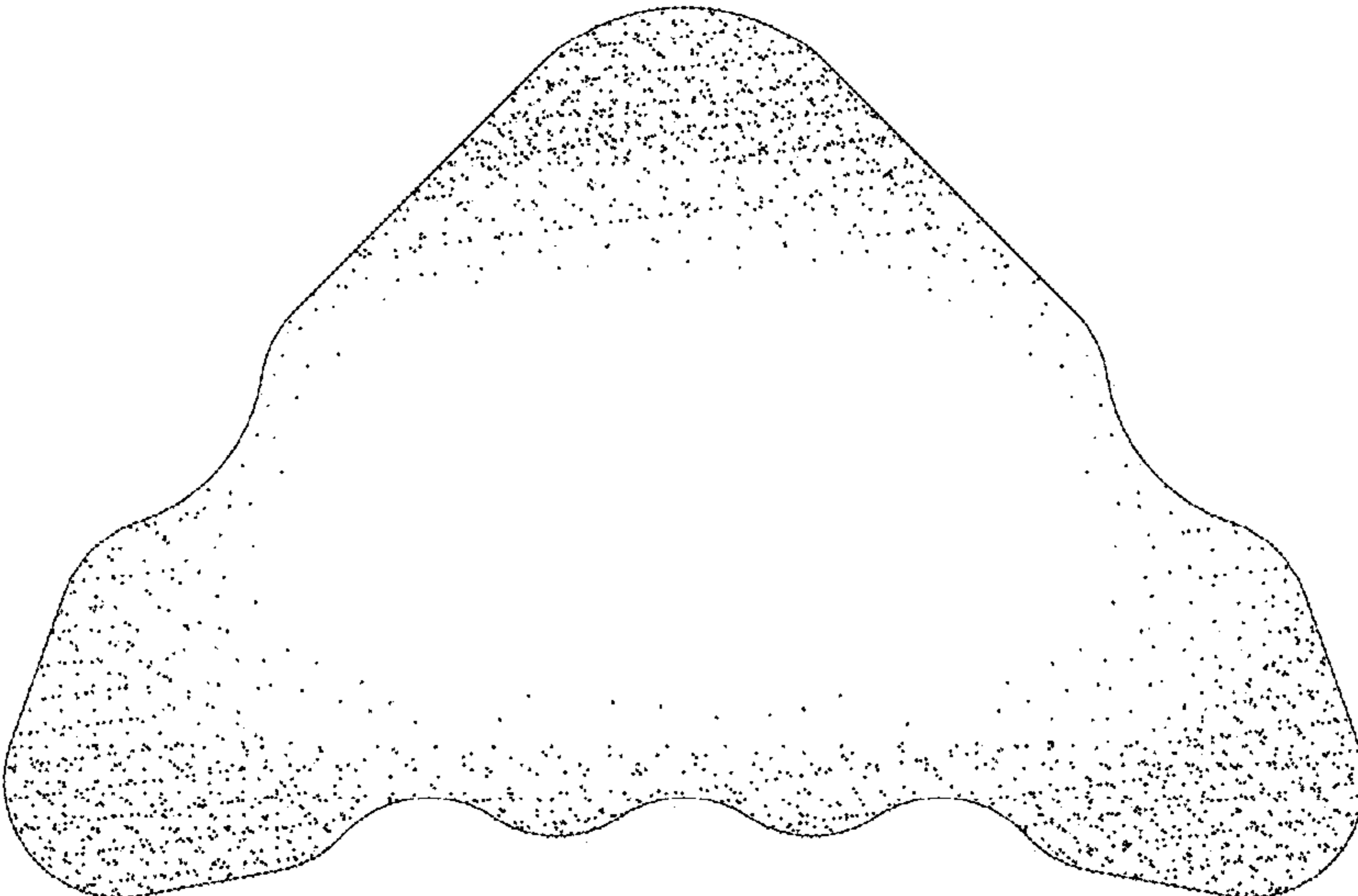

FIG. 5

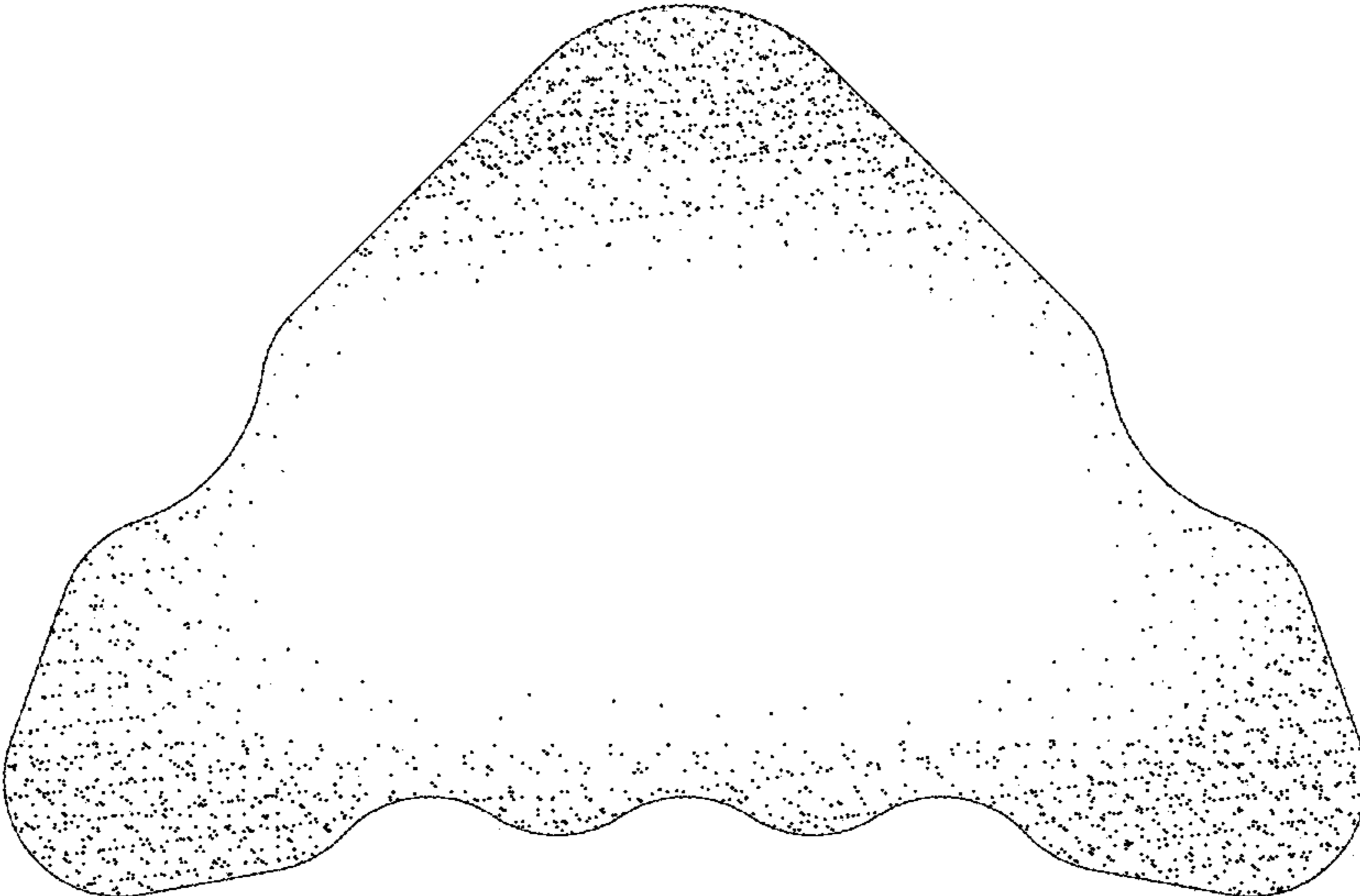

FIG. 6

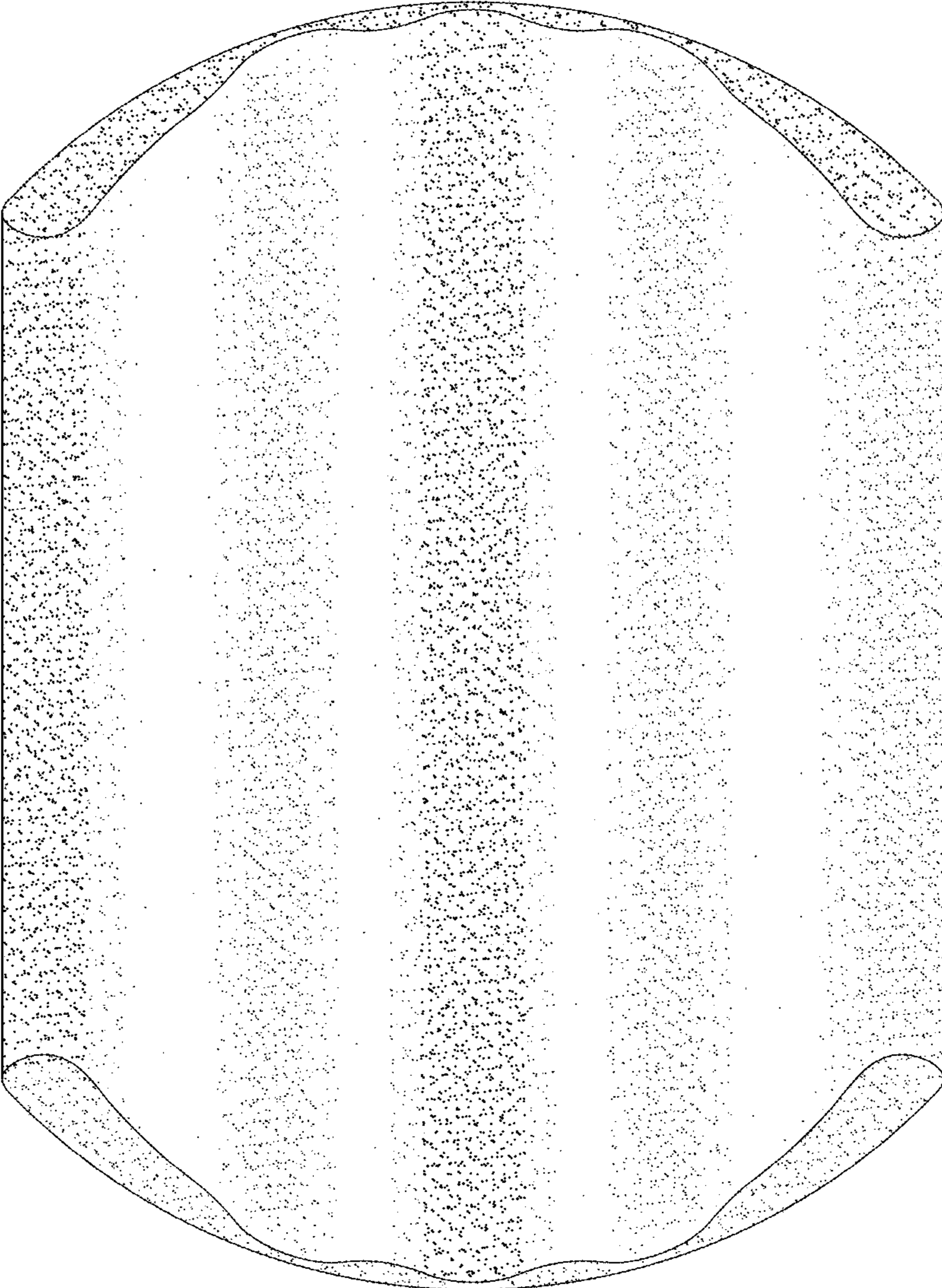

FIG. 7

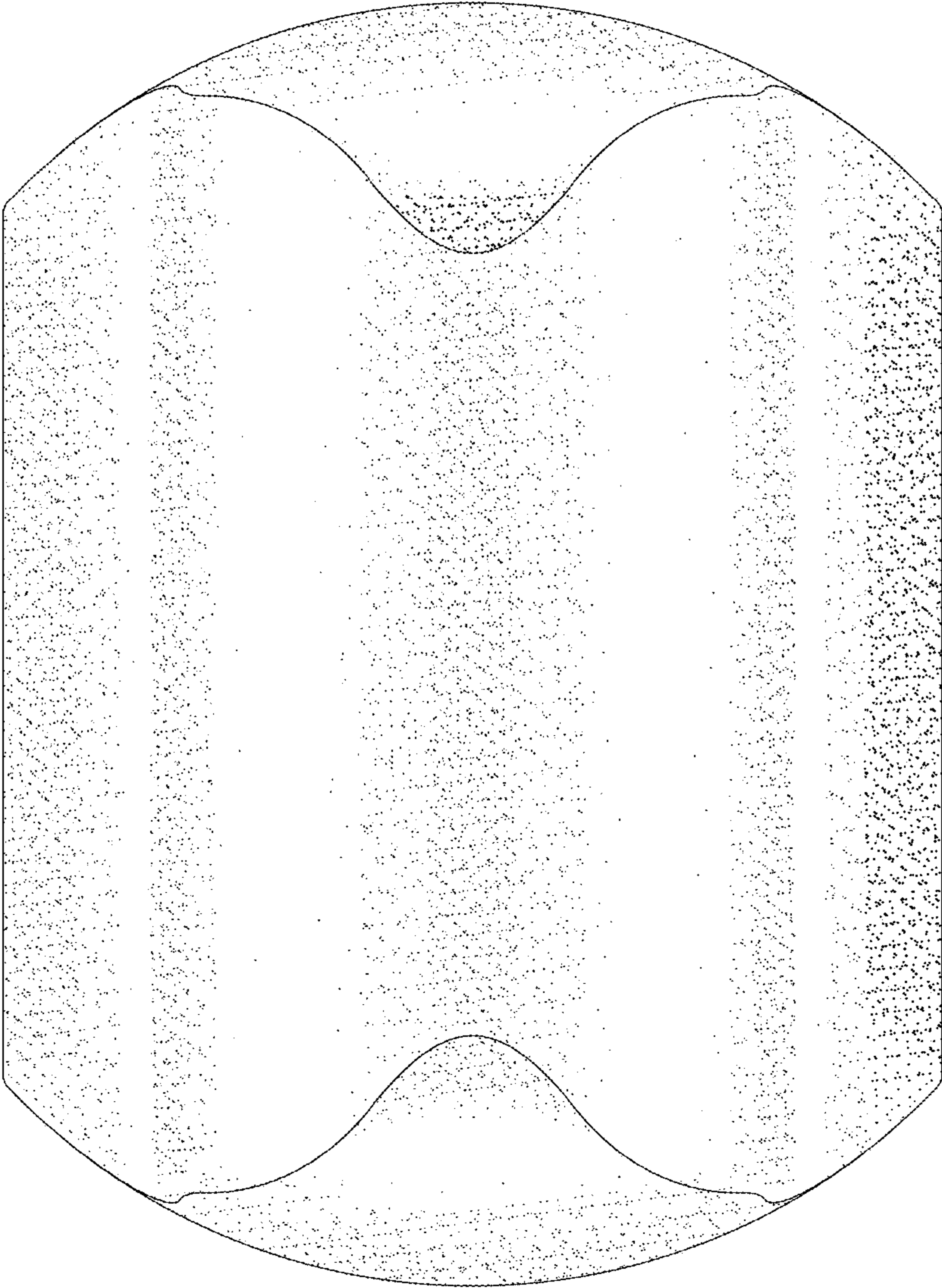

FIG. 8

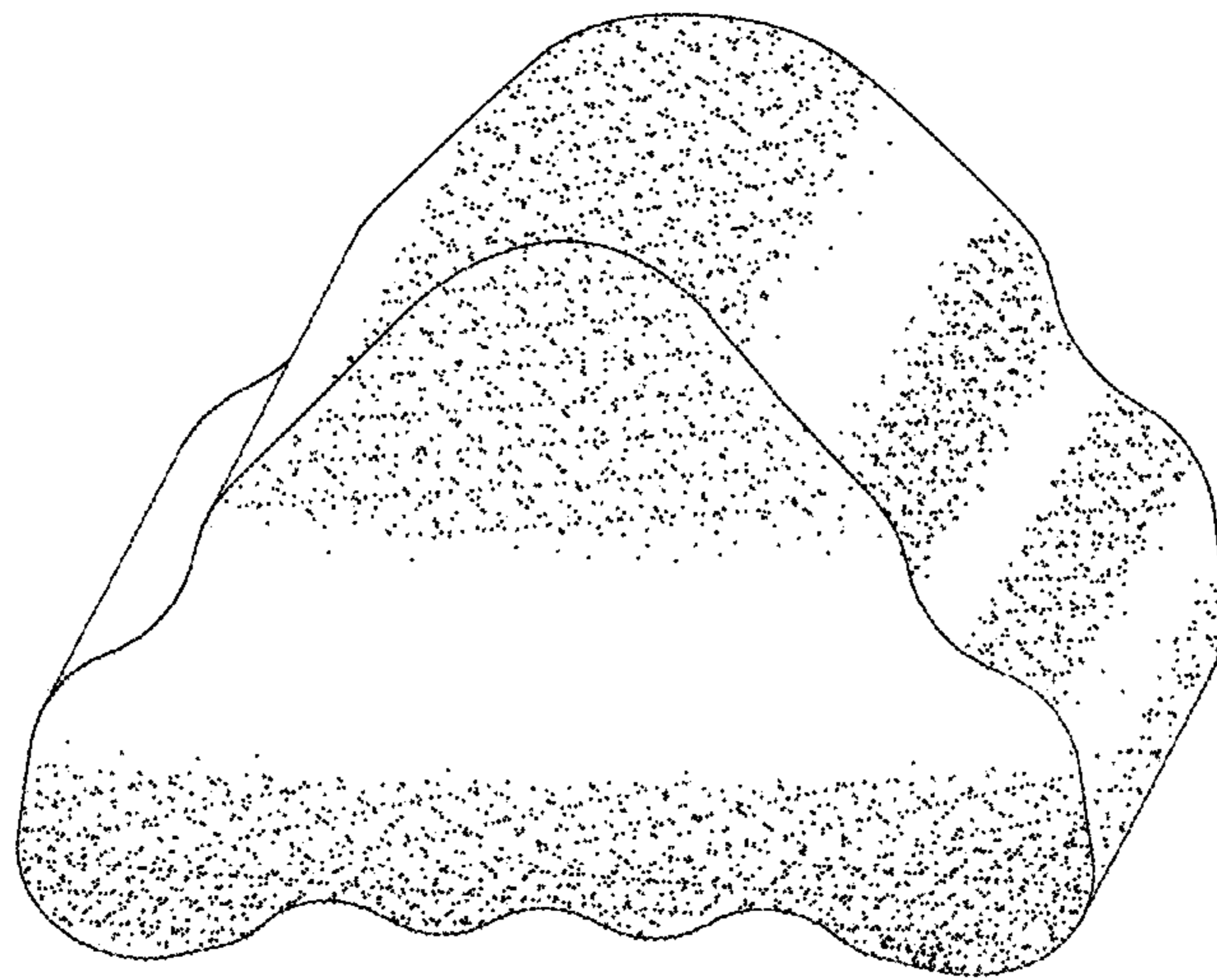

FIG. 9

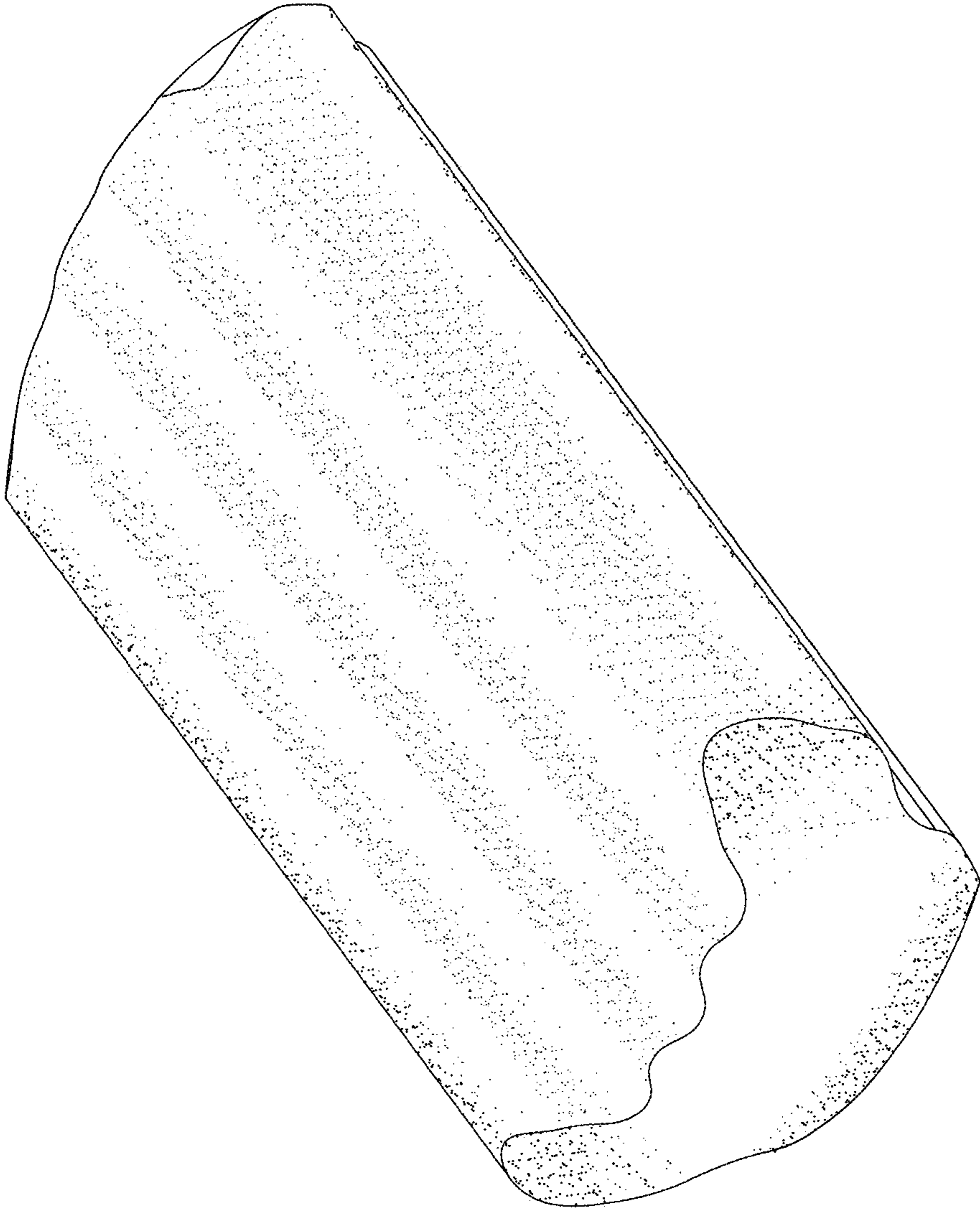

FIG. 10

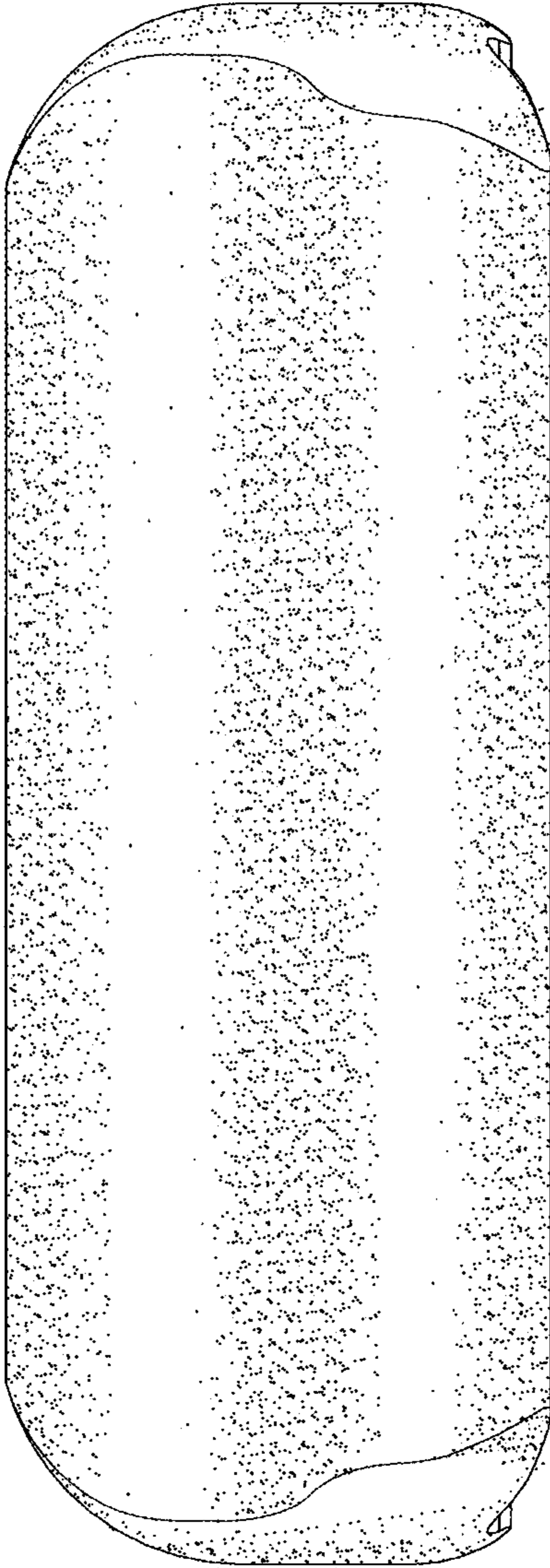

FIG. 11

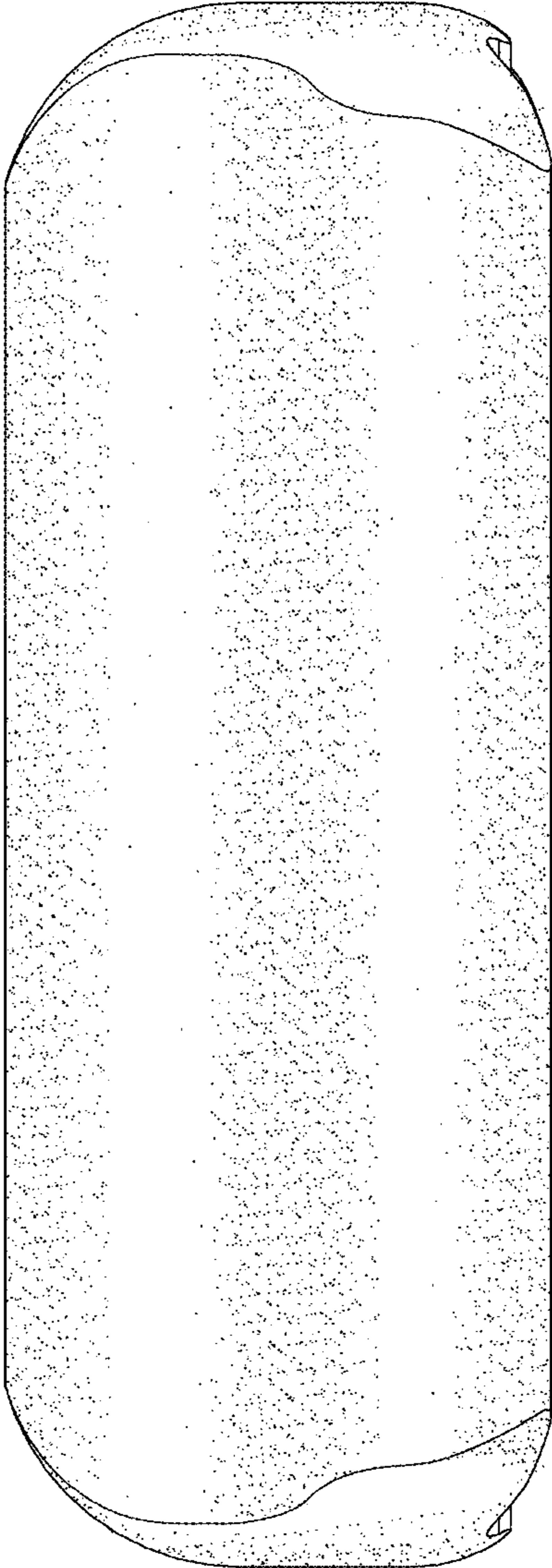

FIG. 12

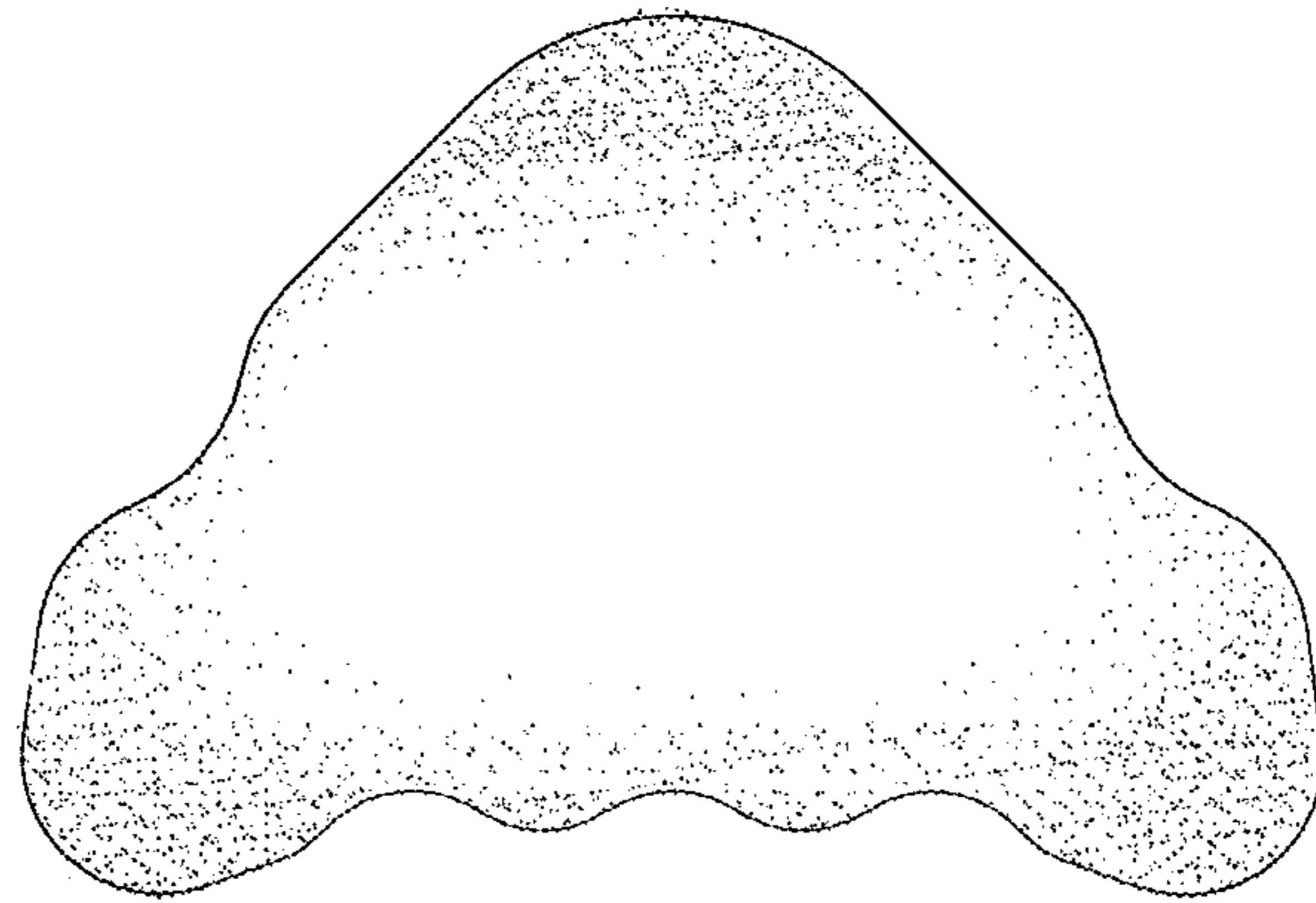

FIG. 13

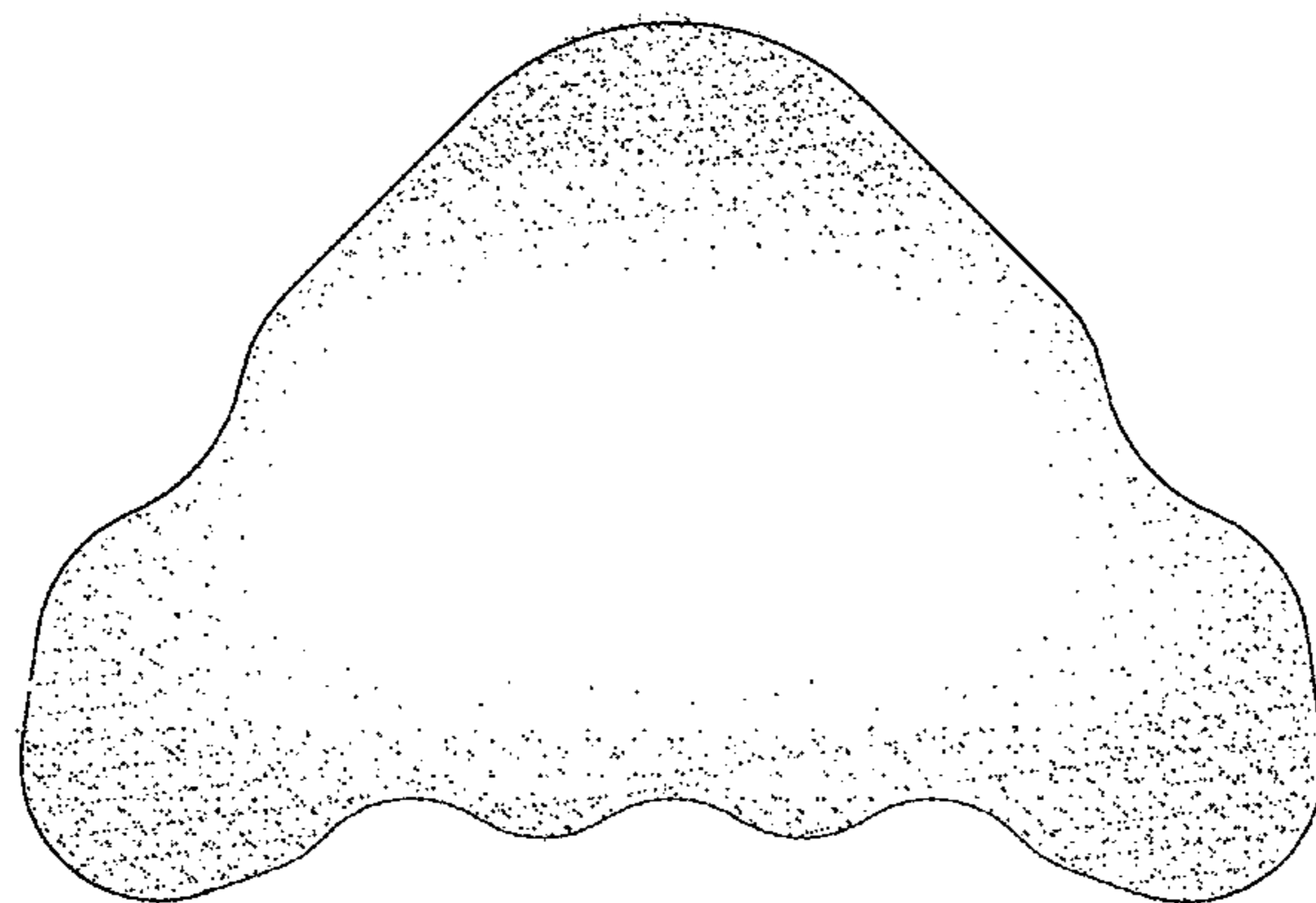

FIG. 14

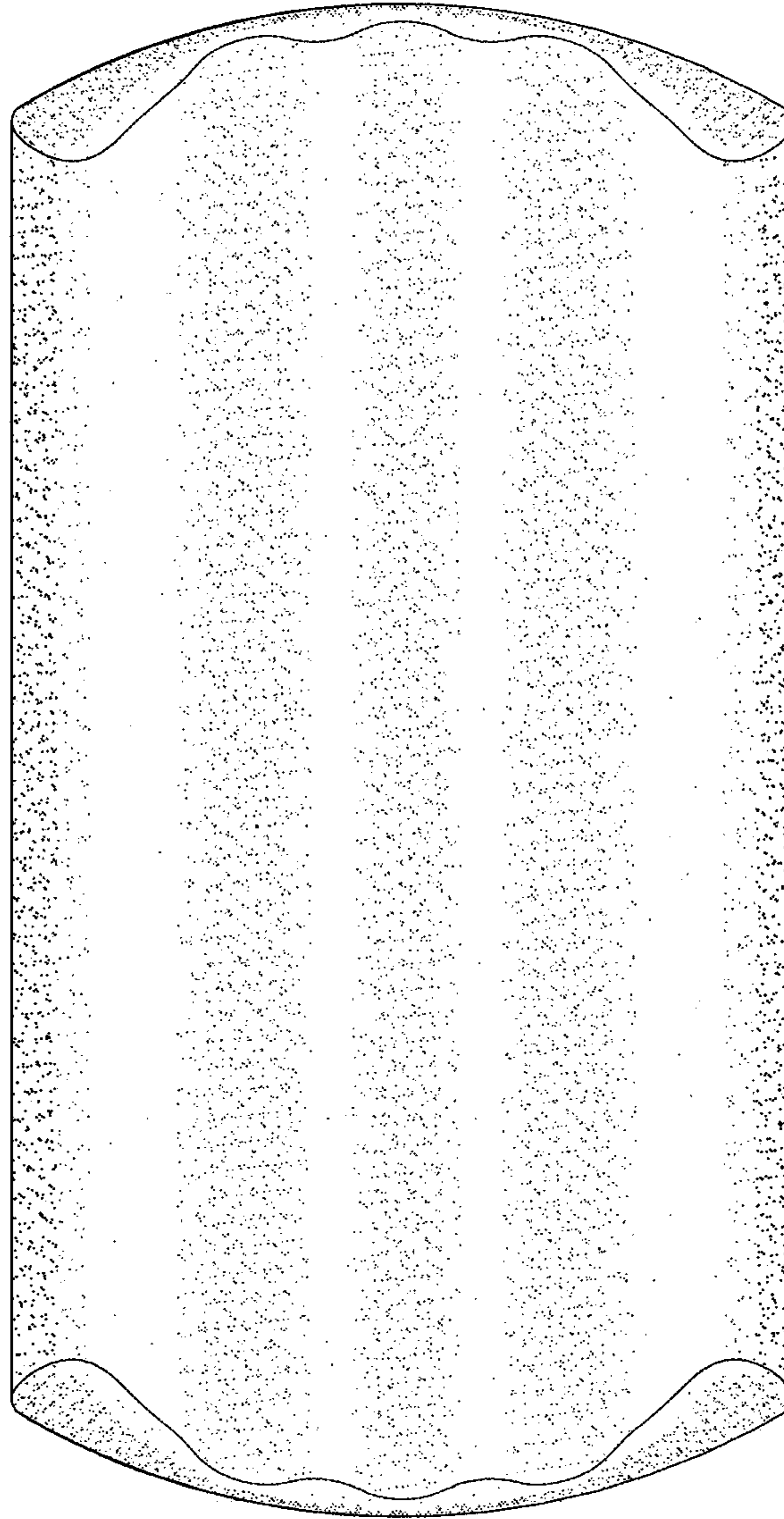

FIG. 15

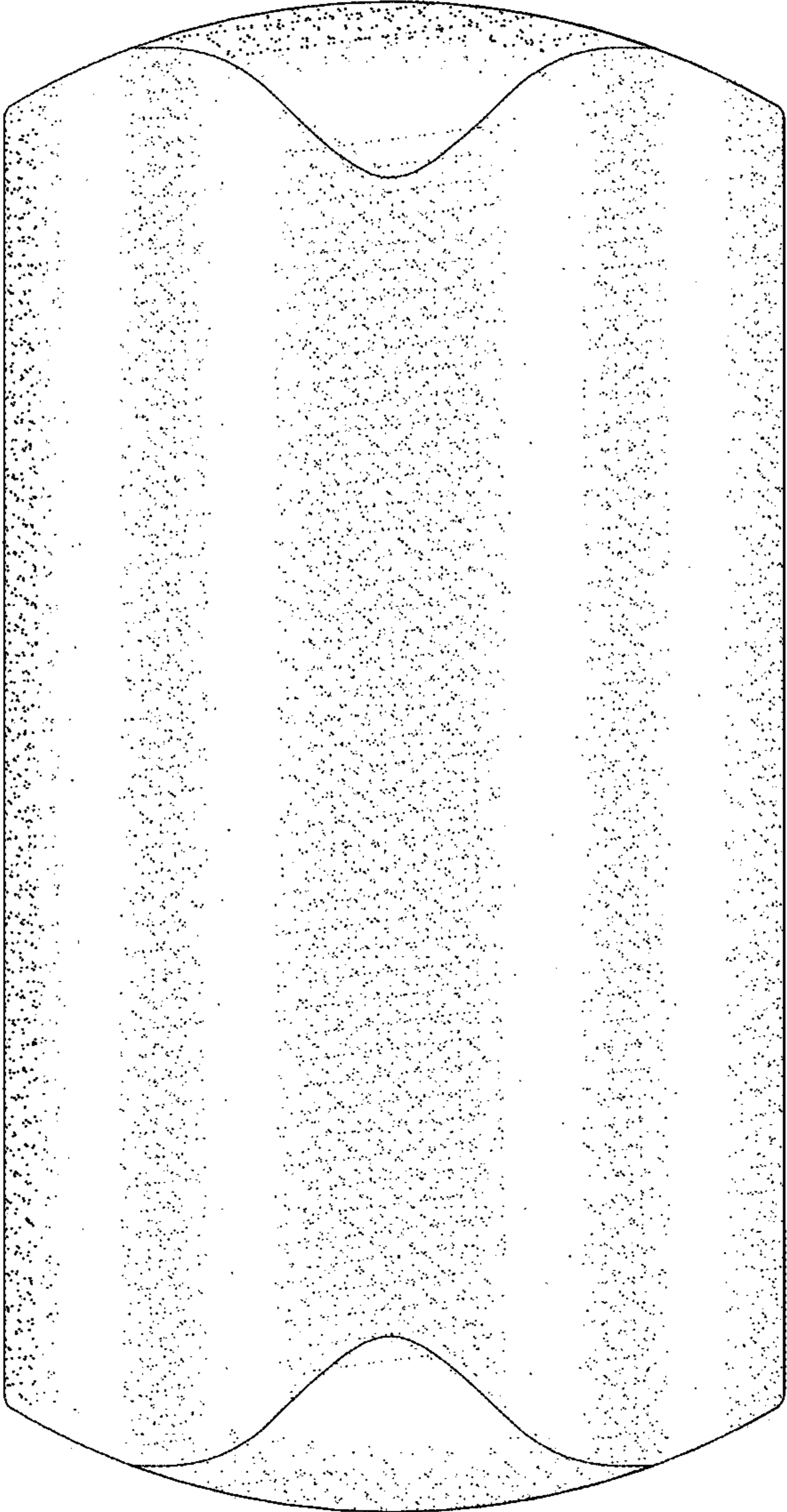

FIG. 16

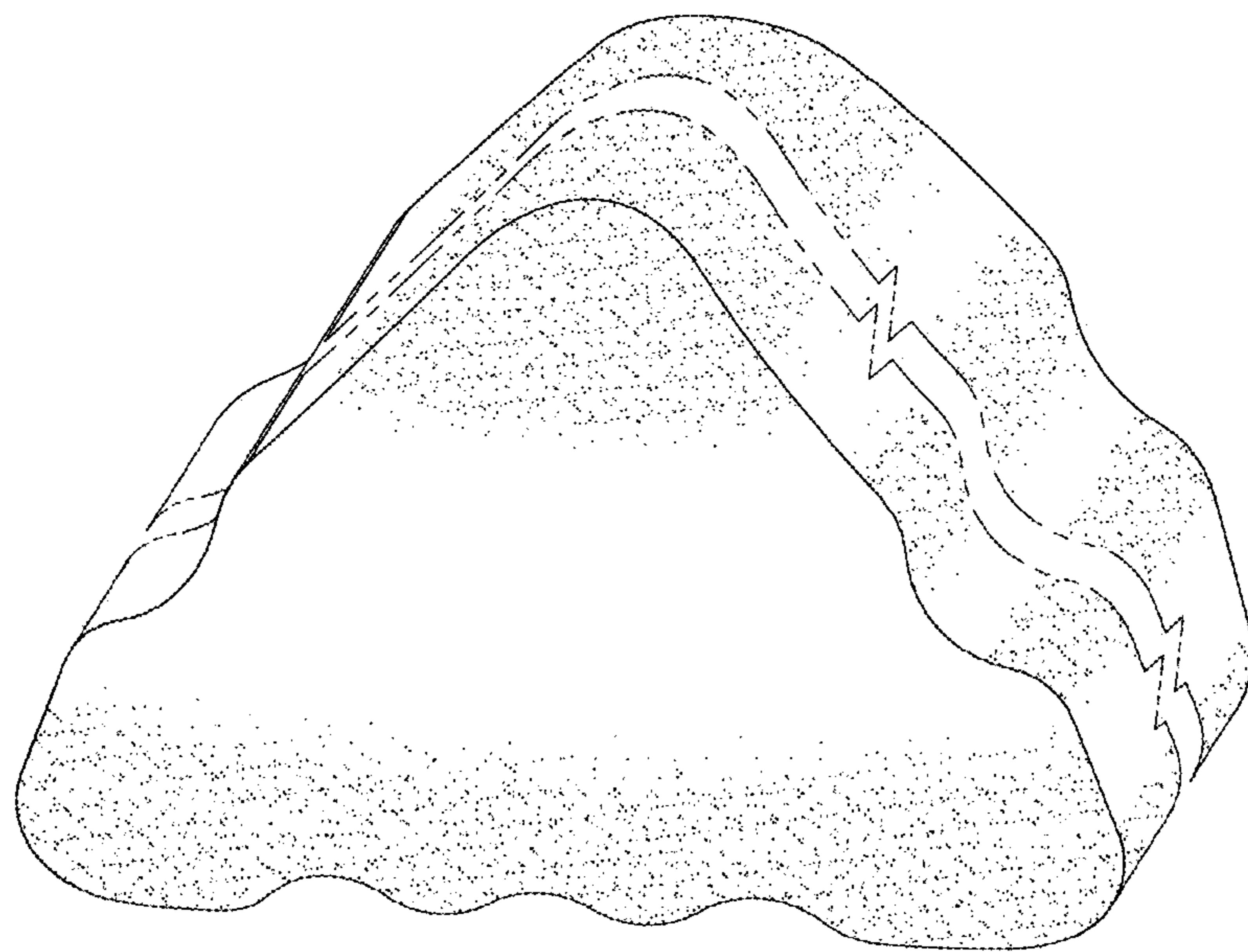

FIG. 17

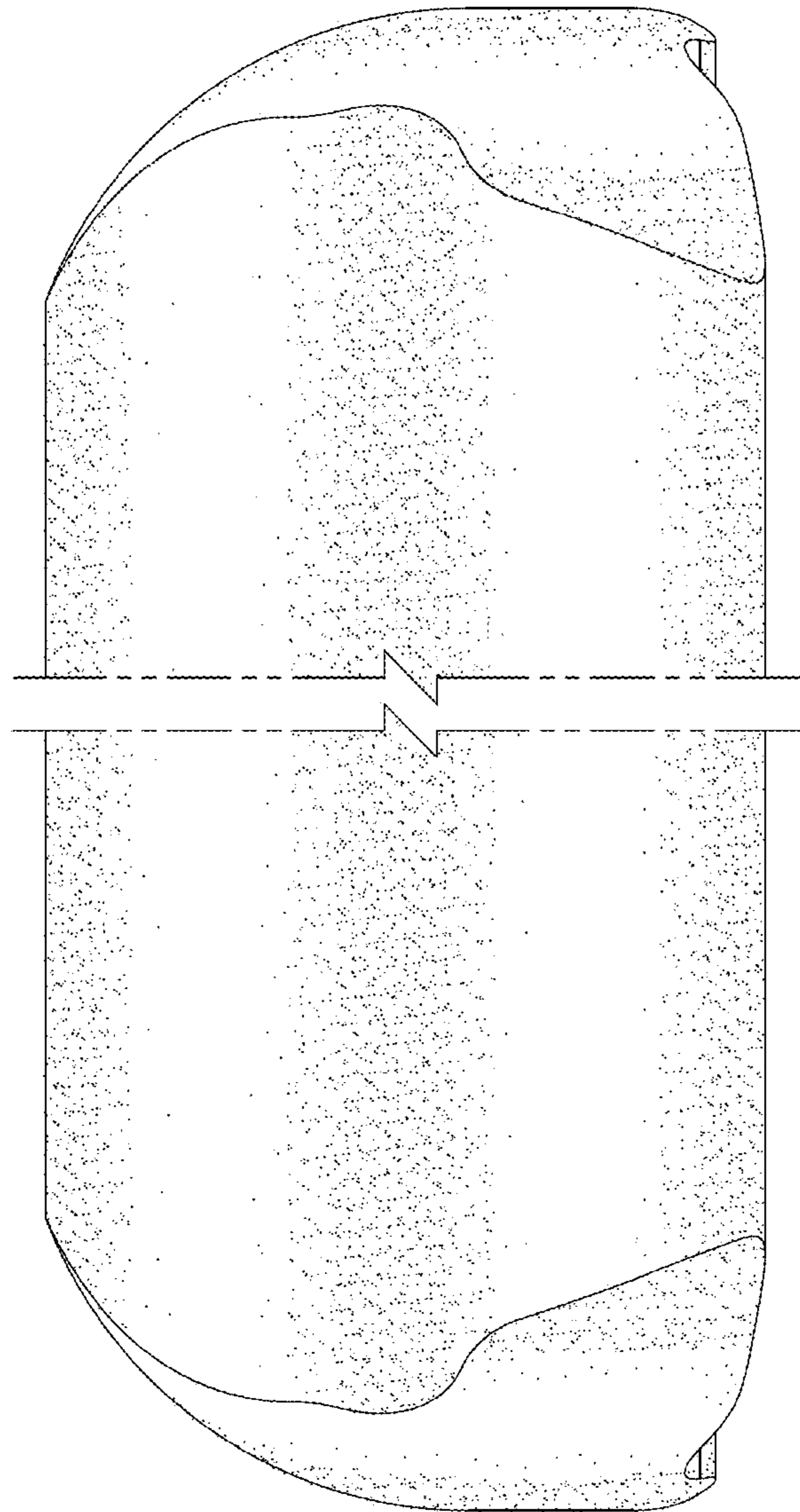

FIG. 18

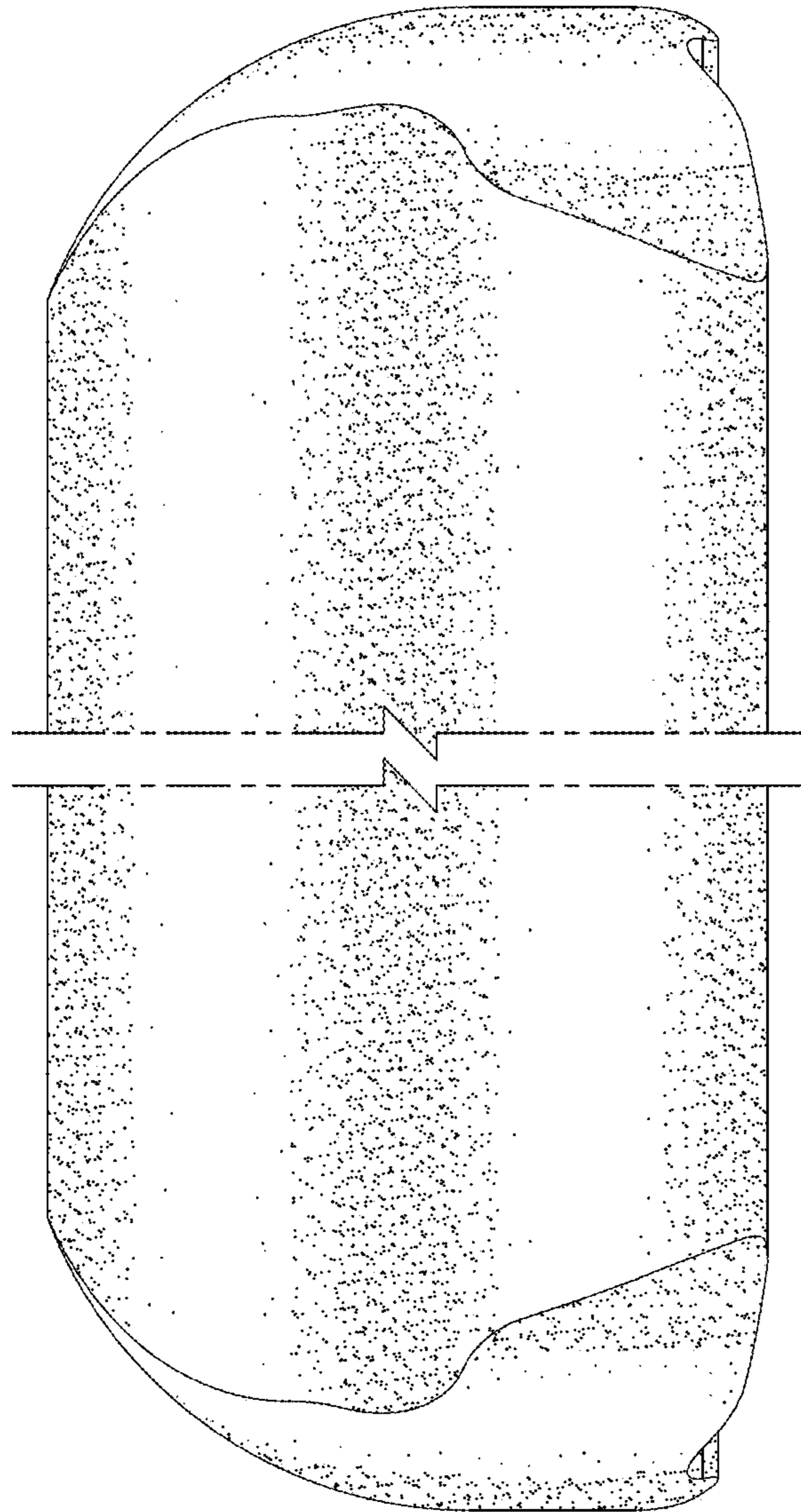

FIG. 19

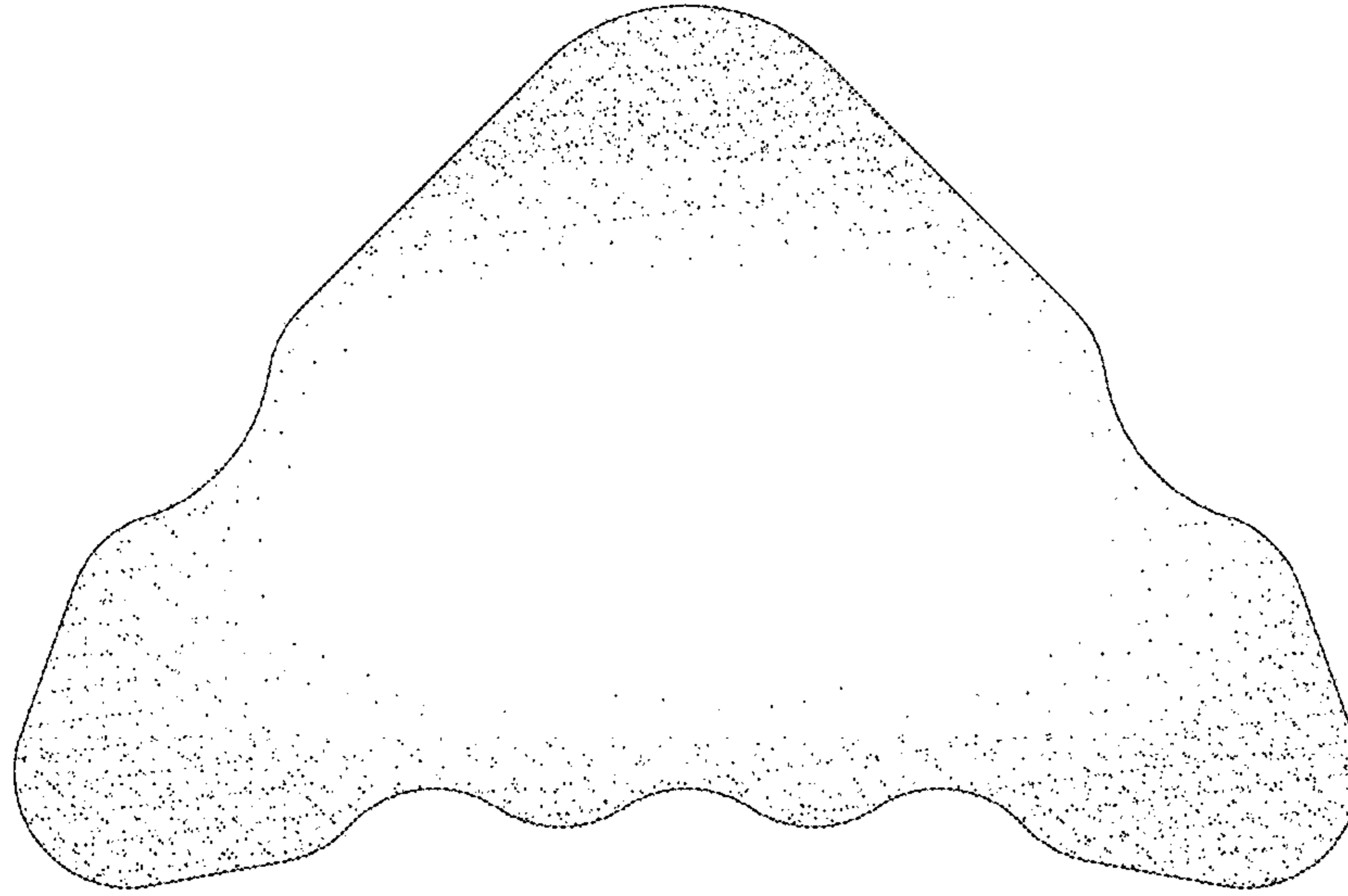

FIG. 20

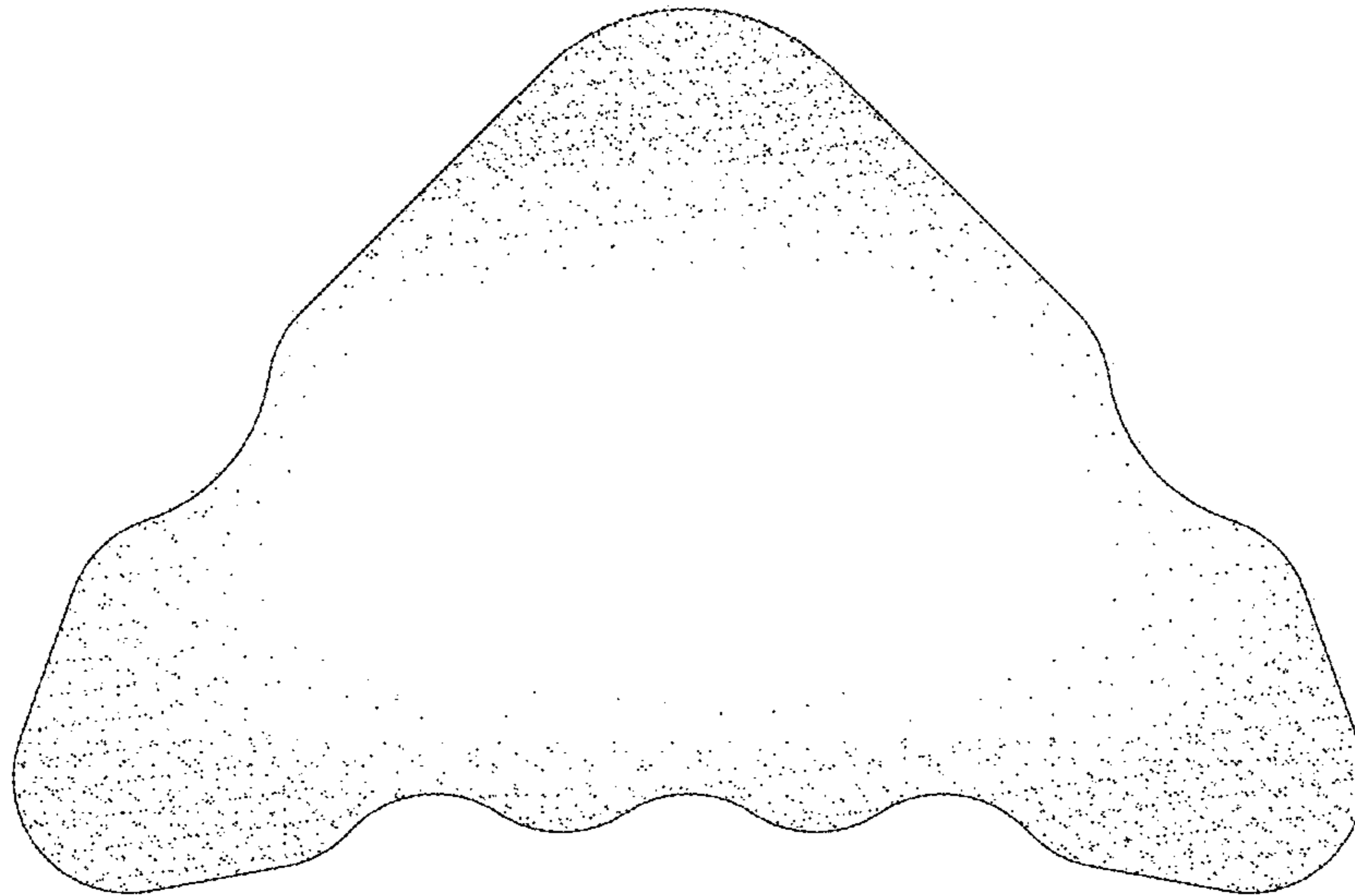

FIG. 21

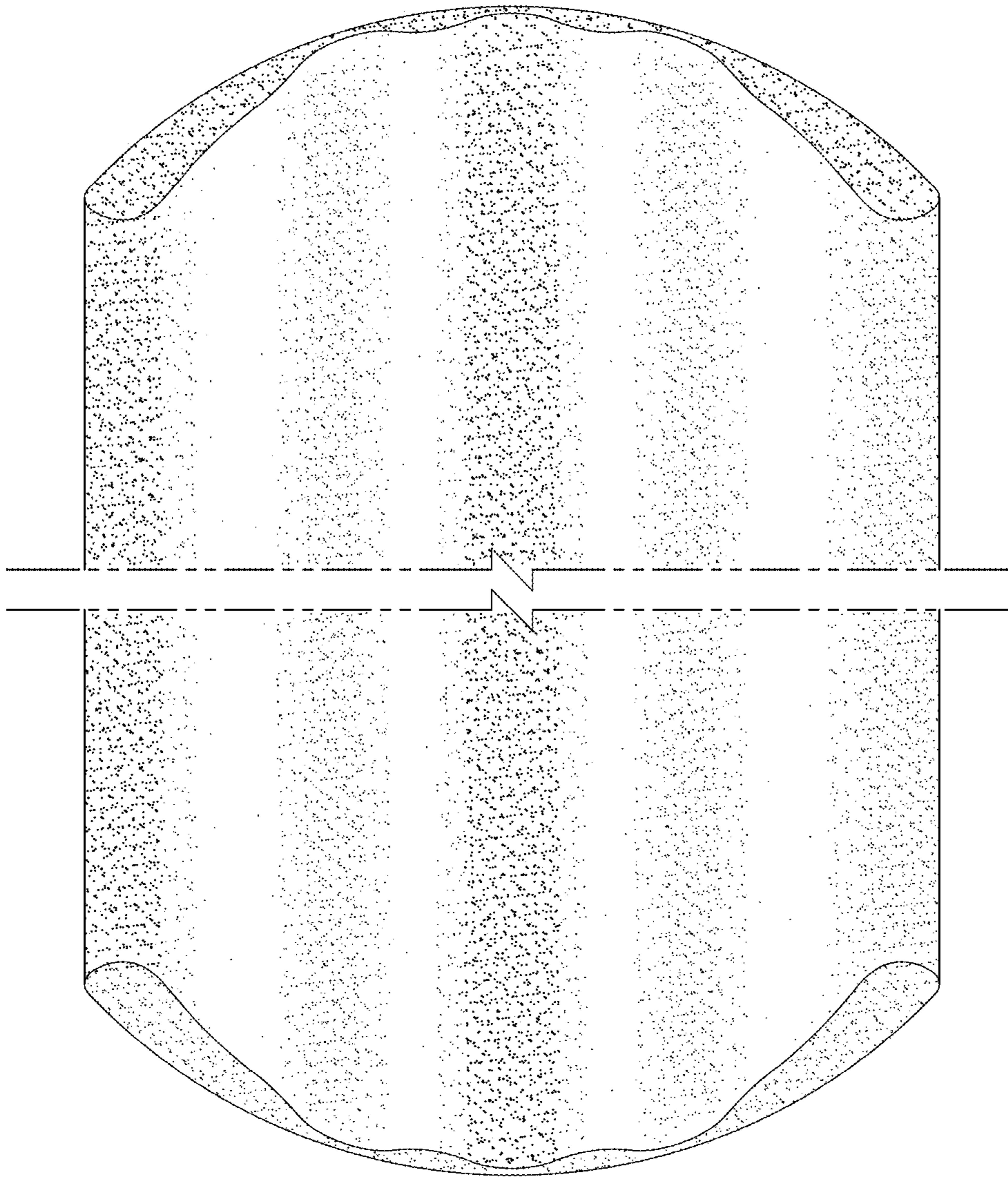

FIG. 22

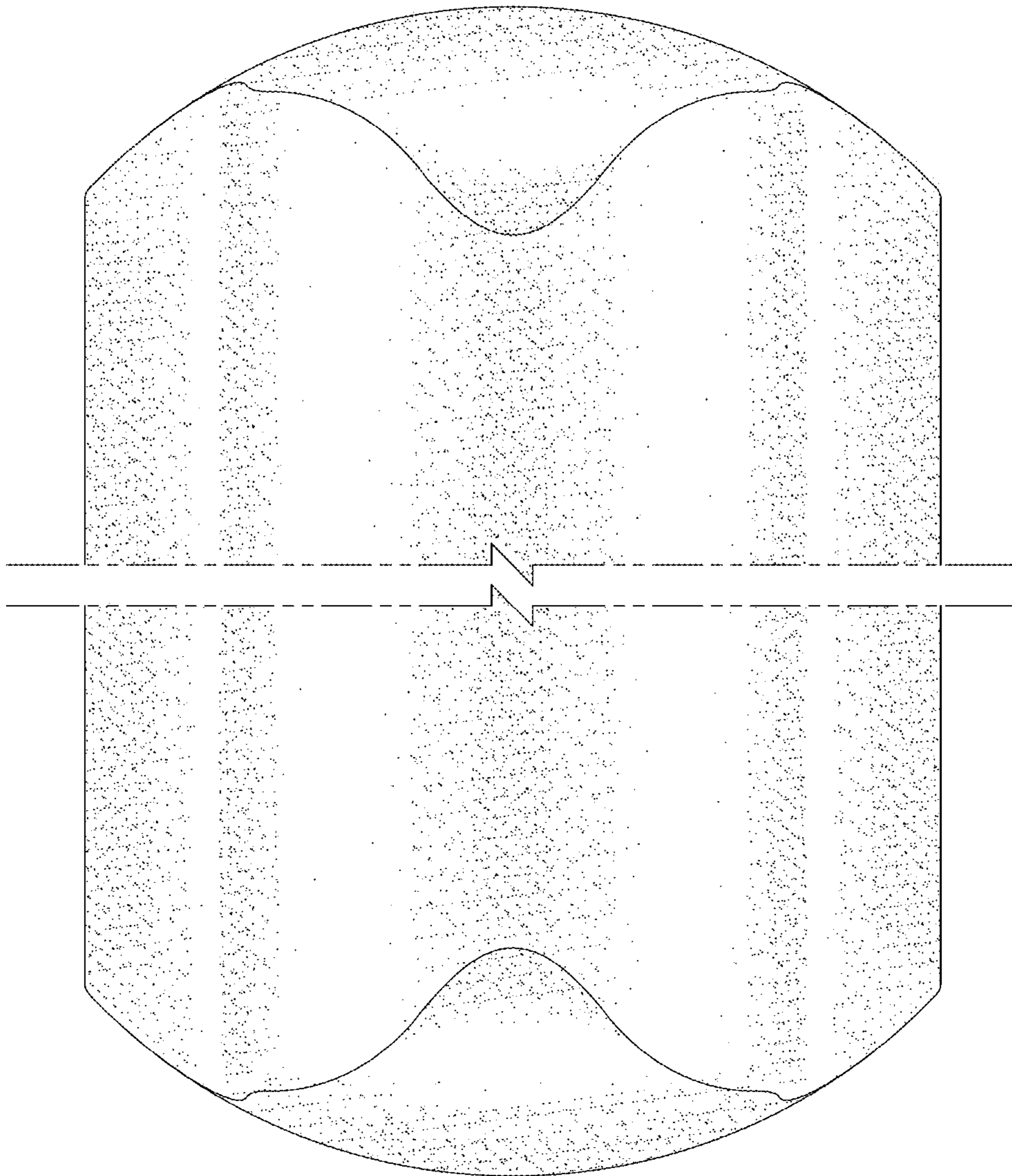

FIG. 23