



US00D837461S

(12) **United States Design Patent**
Wu

(10) **Patent No.:** **US D837,461 S**
(45) **Date of Patent:** **** Jan. 1, 2019**

(54) **BELT FOR WELDING HELMET**
(71) Applicant: **Tecmen Electronics Co., Ltd.**, Nanjing (CN)
(72) Inventor: **Ziqian Wu**, Nanjing (CN)
(73) Assignee: **Tecmen Electronics Co., Ltd.**, Nanjing (CN)
(**) Term: **15 Years**
(21) Appl. No.: **29/588,317**
(22) Filed: **Dec. 20, 2016**

(30) **Foreign Application Priority Data**

Aug. 26, 2016 (CN) 2016 3 0425883

(51) **LOC (11) Cl.** **29-02**

(52) **U.S. Cl.**
USPC **D29/122**

(58) **Field of Classification Search**

USPC D29/102-107, 122; 2/5, 6.1, 6.3, 6.7,
2/41-412, 414, 422-425, 9, 10; D2/869,
D2/870, 872, 882, 884, 891

CPC A42B 3/00; A42B 3/127; F41H 1/08
See application file for complete search history.

(56) **References Cited**

U.S. PATENT DOCUMENTS

D398,403 S * 9/1998 Bishop D24/231
D654,224 S 2/2012 Wu
D654,225 S 2/2012 Wu
D654,226 S 2/2012 Wu

D654,634 S 2/2012 Wu
D668,000 S * 9/2012 Folkesson D29/122
D696,469 S * 12/2013 Pfanner D29/122
D710,493 S 8/2014 Wu
D710,494 S 8/2014 Wu
D710,545 S 8/2014 Wu
D710,546 S 8/2014 Wu
D716,505 S 10/2014 Wu
D716,506 S 10/2014 Wu
D732,746 S 6/2015 Wu
D734,558 S 7/2015 Wu
D767,829 S 9/2016 Wu
D774,180 S 12/2016 Wu
D775,344 S 12/2016 Wu

* cited by examiner

Primary Examiner — Randall H Gholson

(57) **CLAIM**

The ornamental design for a belt for welding helmet, as shown and described.

DESCRIPTION

FIG. 1 is a top, front, right side perspective view of a belt for welding helmet showing my new design; FIG. 2 is a front elevational view thereof; FIG. 3 is a rear elevational view thereof; FIG. 4 is a right elevational side view thereof; FIG. 5 is a left elevational side view thereof; FIG. 6 is a top plan view thereof; and, FIG. 7 is a bottom plan view thereof.

The broken lines shown in the drawings represent portions of the belt for welding helmet that form no part of the claimed design.

1 Claim, 7 Drawing Sheets

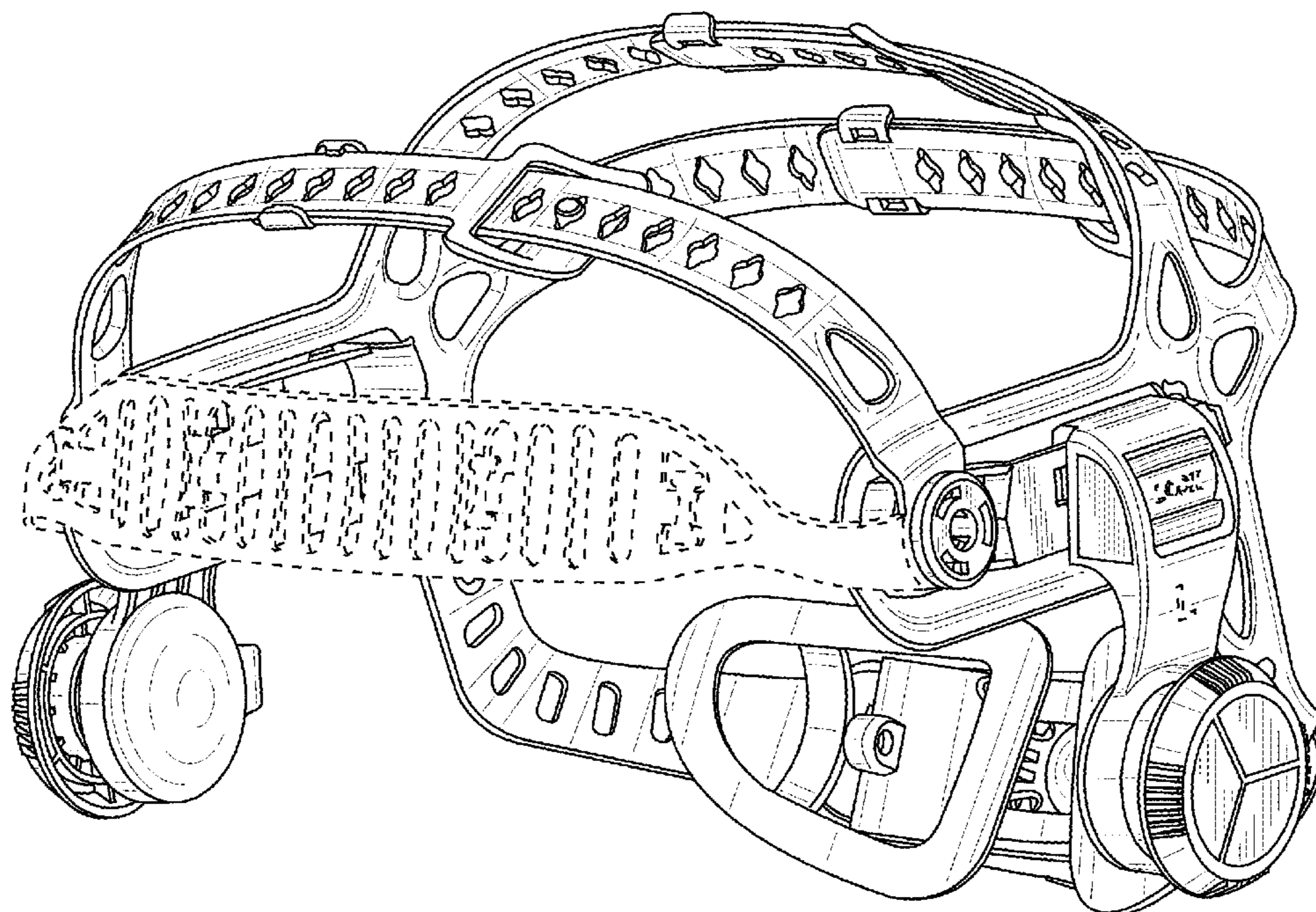

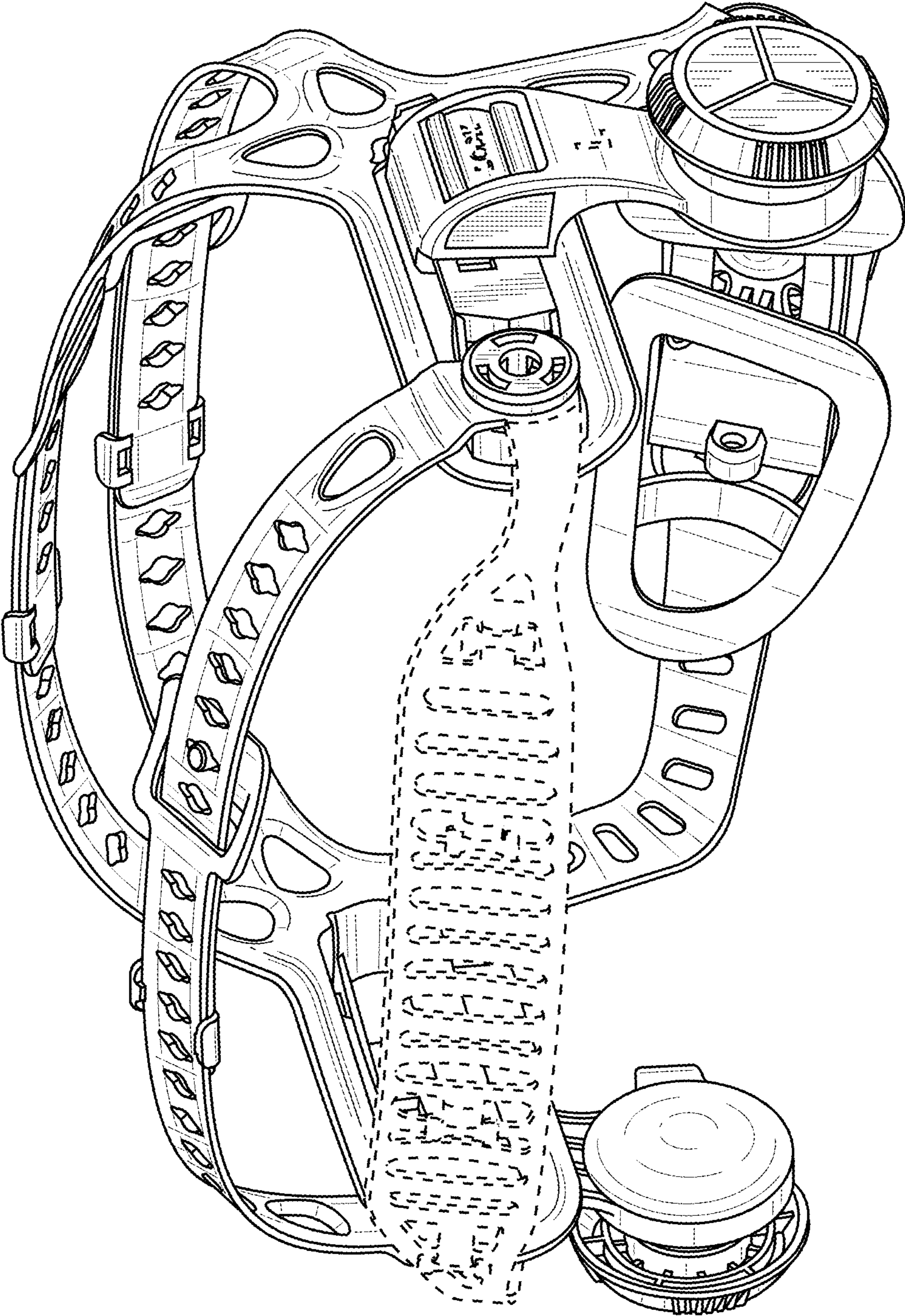

FIG. 1



FIG. 2



FIG. 3

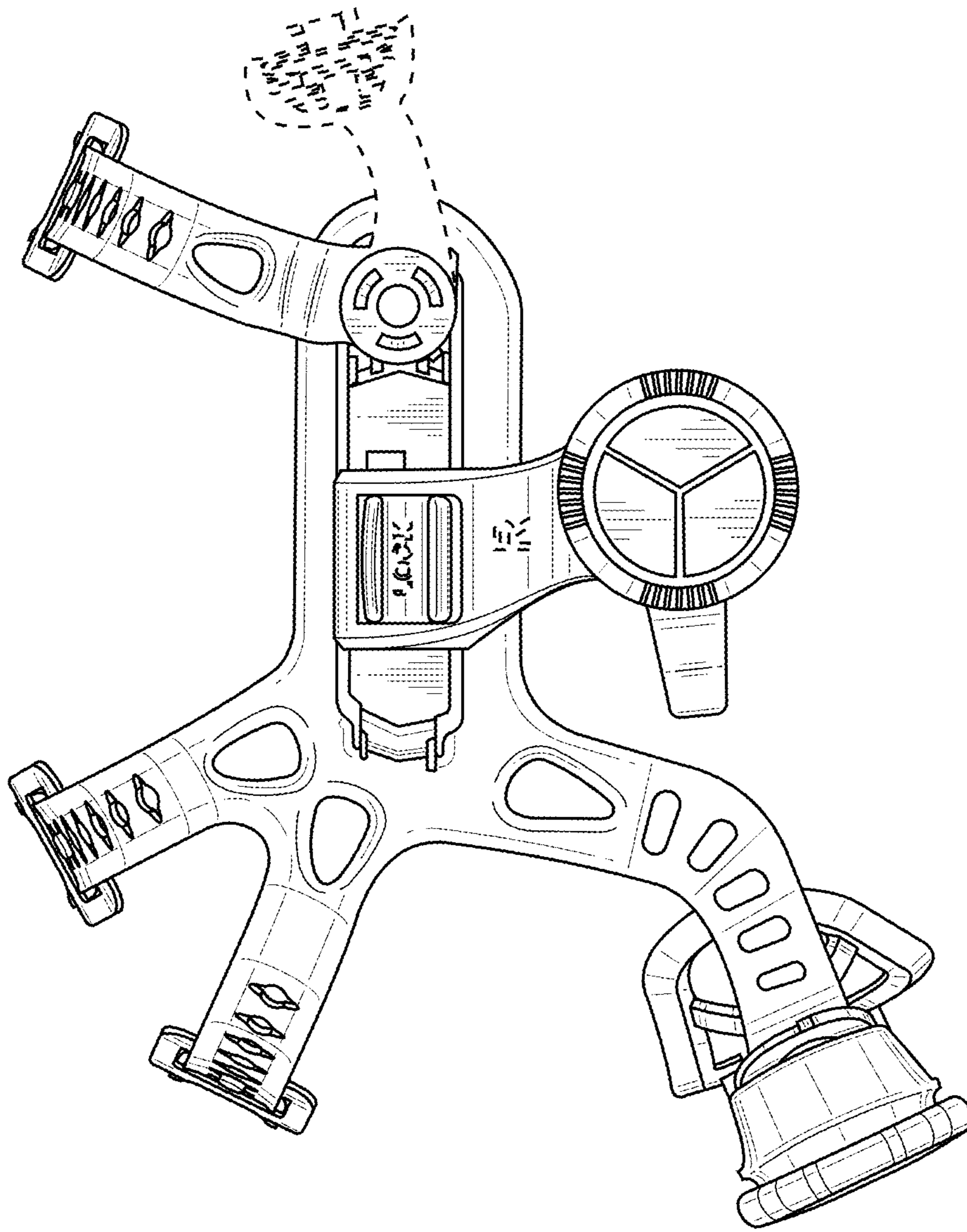

FIG. 4

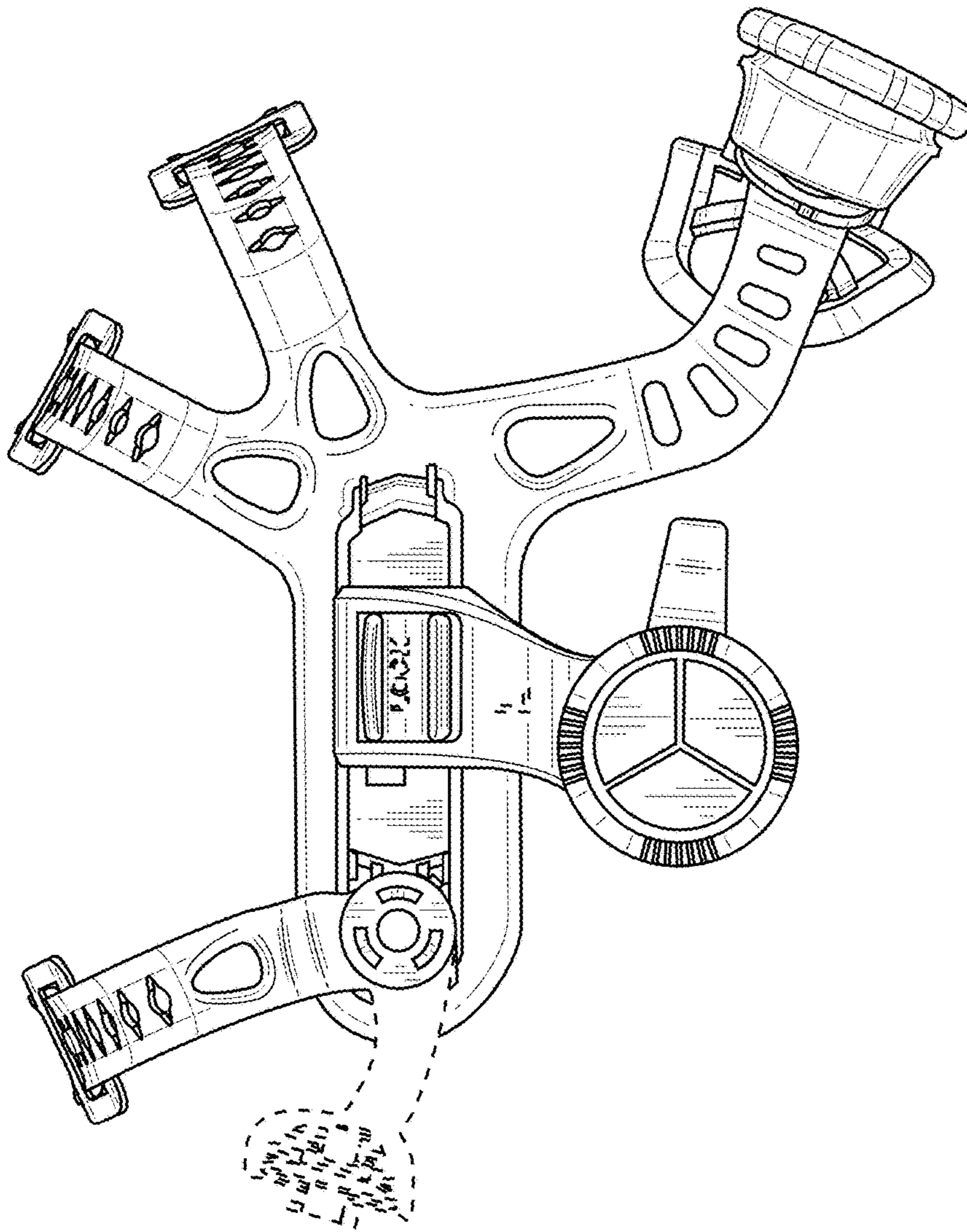

FIG. 5

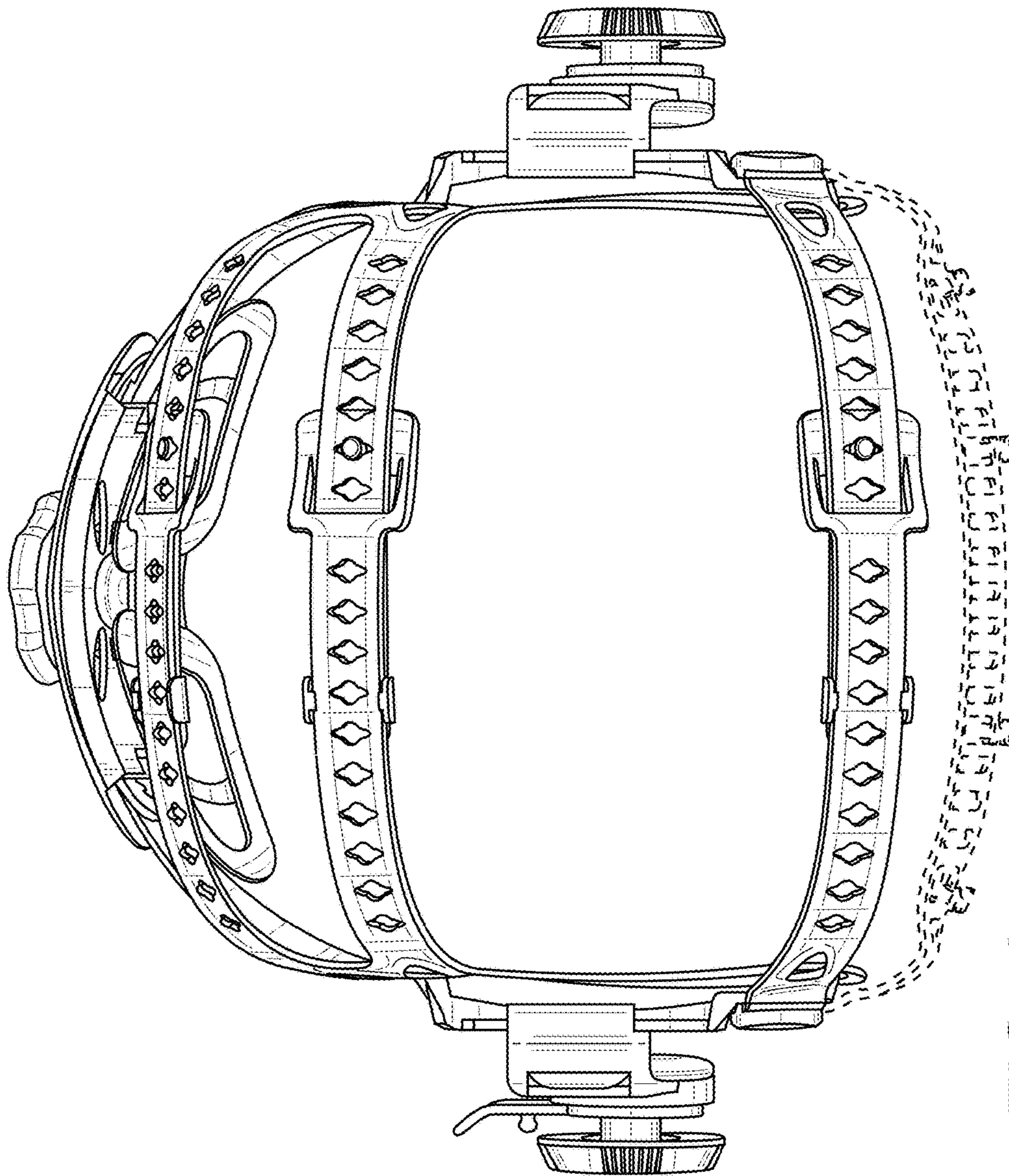

FIG. 6

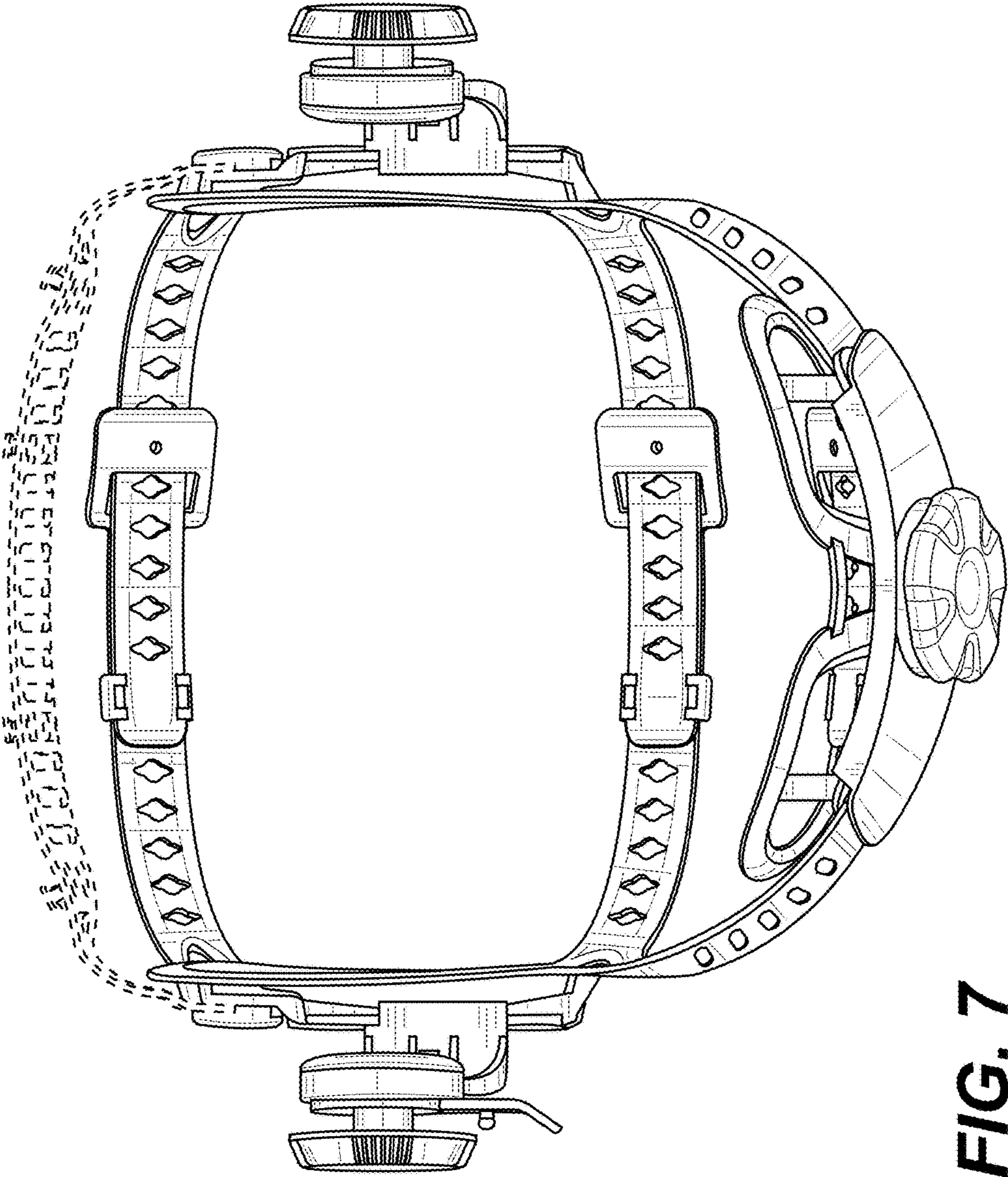

FIG. 7