



US00D837445S

(12) **United States Design Patent**
Thomas

(10) **Patent No.:** **US D837,445 S**
(45) **Date of Patent:** **** Jan. 1, 2019**

(54) **HEAD LIGHT LENS**

(71) Applicant: **Jaguar Land Rover Limited**, Whitley,
Coventry (GB)

(72) Inventor: **Gareth Thomas**, Coventry (GB)

(73) Assignee: **Jaguar Land Rover Limited**, Whitley
Coventry (GB)

(**) Term: **15 Years**

(21) Appl. No.: **29/622,572**

(22) Filed: **Oct. 18, 2017**

(30) **Foreign Application Priority Data**

Apr. 21, 2017 (EP) 003866797

(51) **LOC (11) Cl.** **26-99**

(52) **U.S. Cl.**
USPC **D26/139**

(58) **Field of Classification Search**
USPC D26/28-36, 139
CPC B60Q 9/13; B60Q 9/135; B60Q 9/1375;
F21S 48/00; F21S 48/10; F21S 48/115;
F21S 48/225; F21S 48/1233; F21S
48/1266; F21S 48/1388; F21S 48/2268;
F21V 21/04

See application file for complete search history.

(56) **References Cited**

U.S. PATENT DOCUMENTS

D538,956 S * 3/2007 Ishii D26/28
D544,614 S * 6/2007 Markefka D26/28

D561,358 S * 2/2008 Tachibana D26/28
D570,007 S * 5/2008 Hsu D26/28
D582,587 S * 12/2008 Yang D26/28
D690,852 S * 10/2013 Cooney D26/28

* cited by examiner

Primary Examiner — Marcus A Jackson

(74) *Attorney, Agent, or Firm* — Wood Herron & Evans
LLP

(57) **CLAIM**

The ornamental design for a head light lens, as shown and
described.

DESCRIPTION

FIG. 1 is a front left perspective view of a head light lens for
a vehicle according to the present invention.
FIG. 2 is a front right perspective view of the head light lens
shown in FIG. 1.
FIG. 3 is a rear right perspective view thereof.
FIG. 4 is a rear left perspective view thereof.
FIG. 5 is a front view thereof.
FIG. 6 is a rear view thereof.
FIG. 7 is a left side view thereof.
FIG. 8 is a right side view thereof.
FIG. 9 is a top view thereof; and,
FIG. 10 is a bottom view thereof.

1 Claim, 10 Drawing Sheets

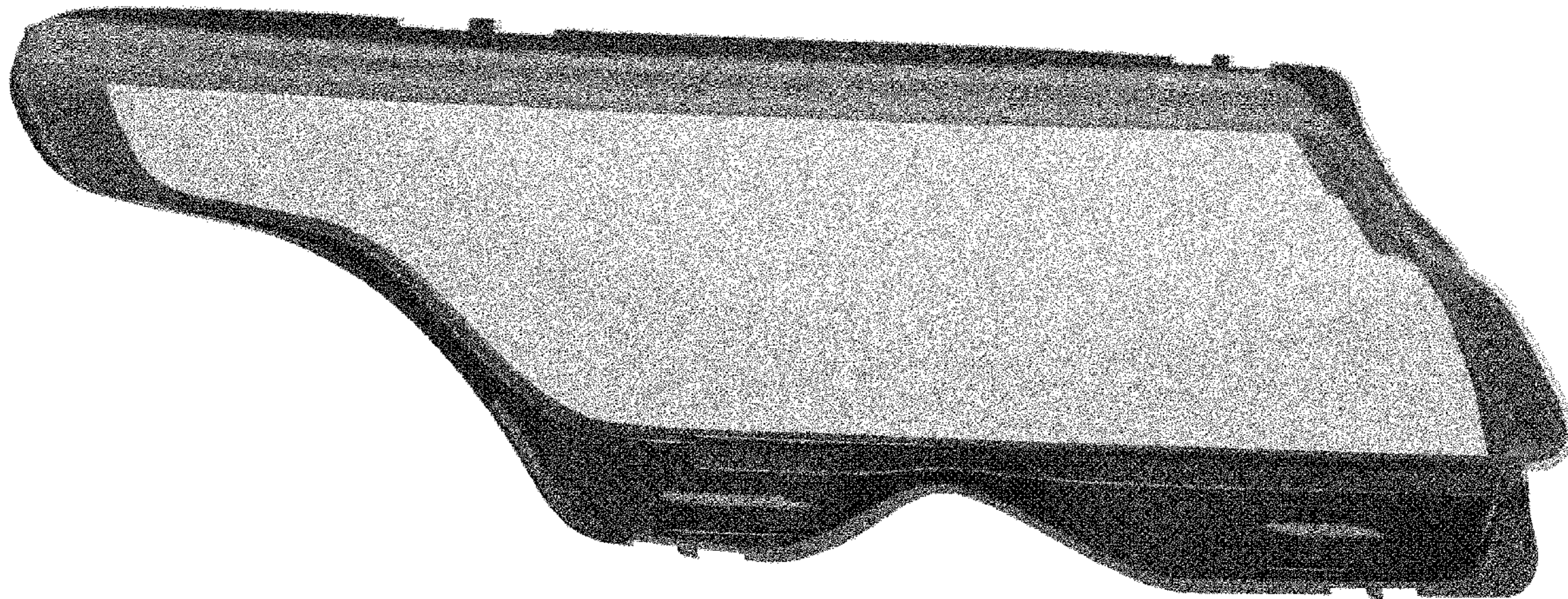

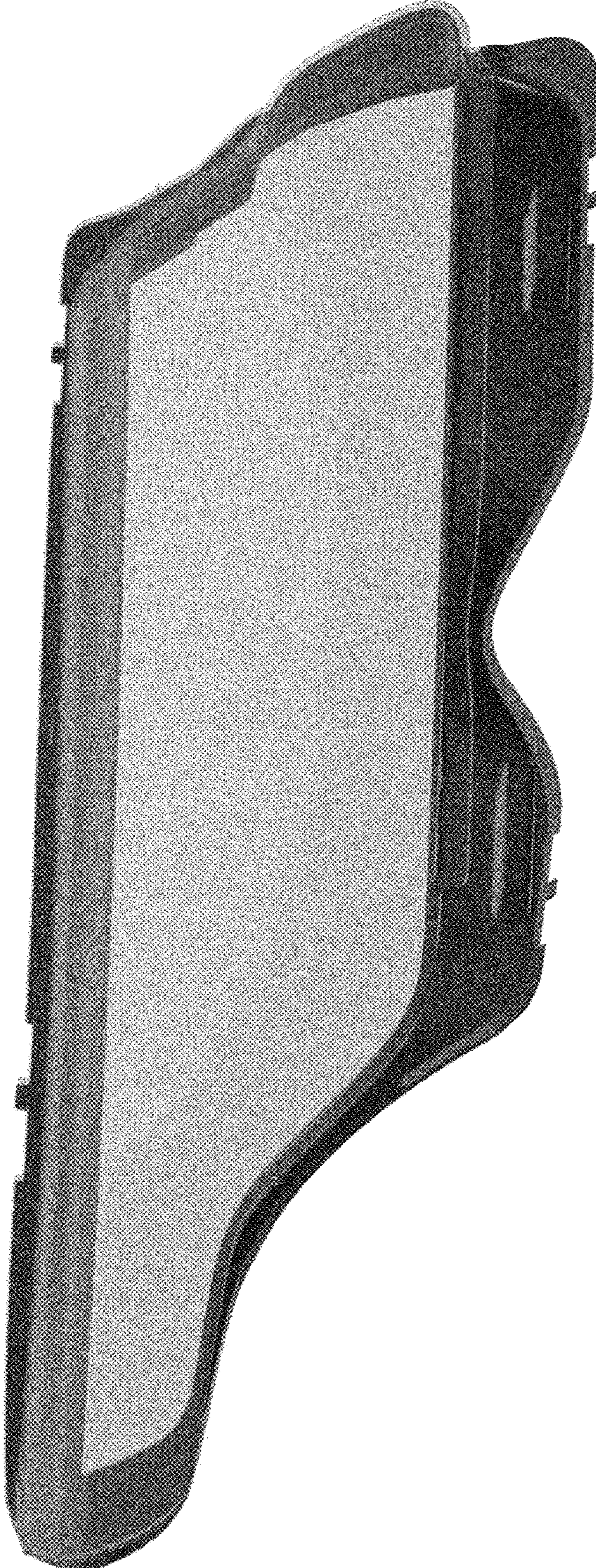

FIG. 1



FIG. 2

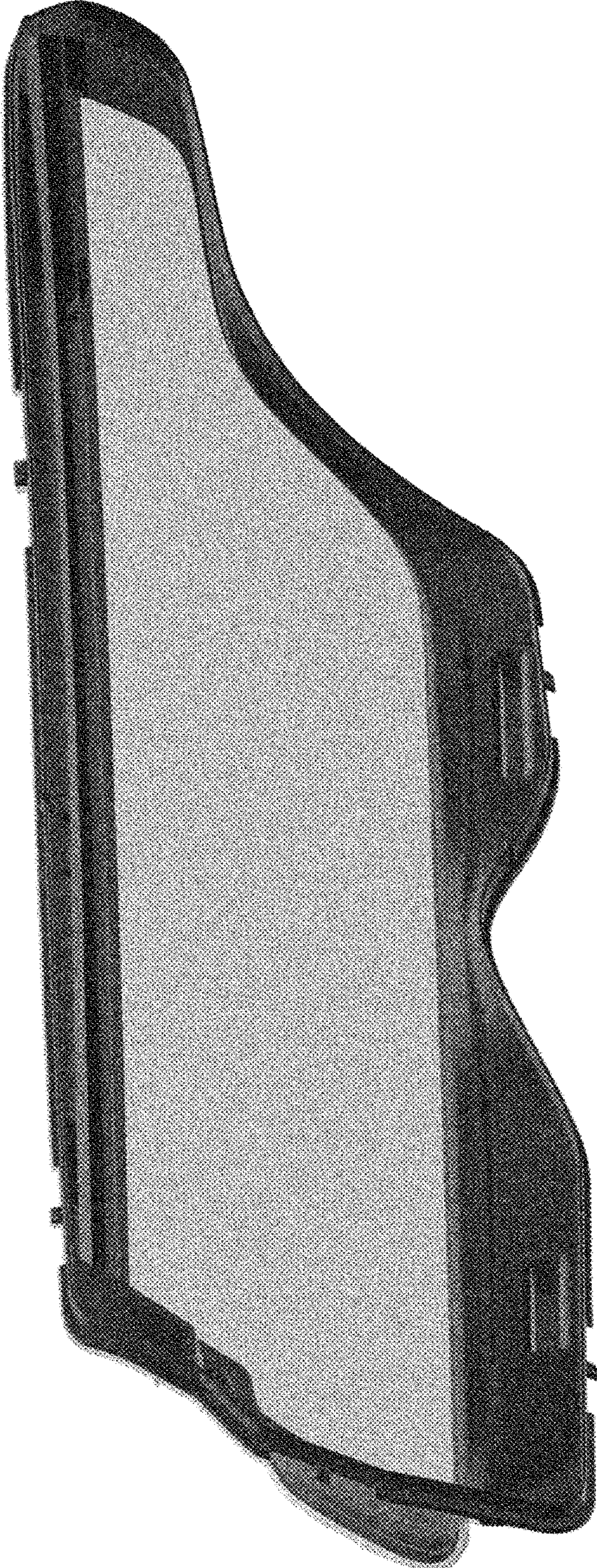

FIG. 3

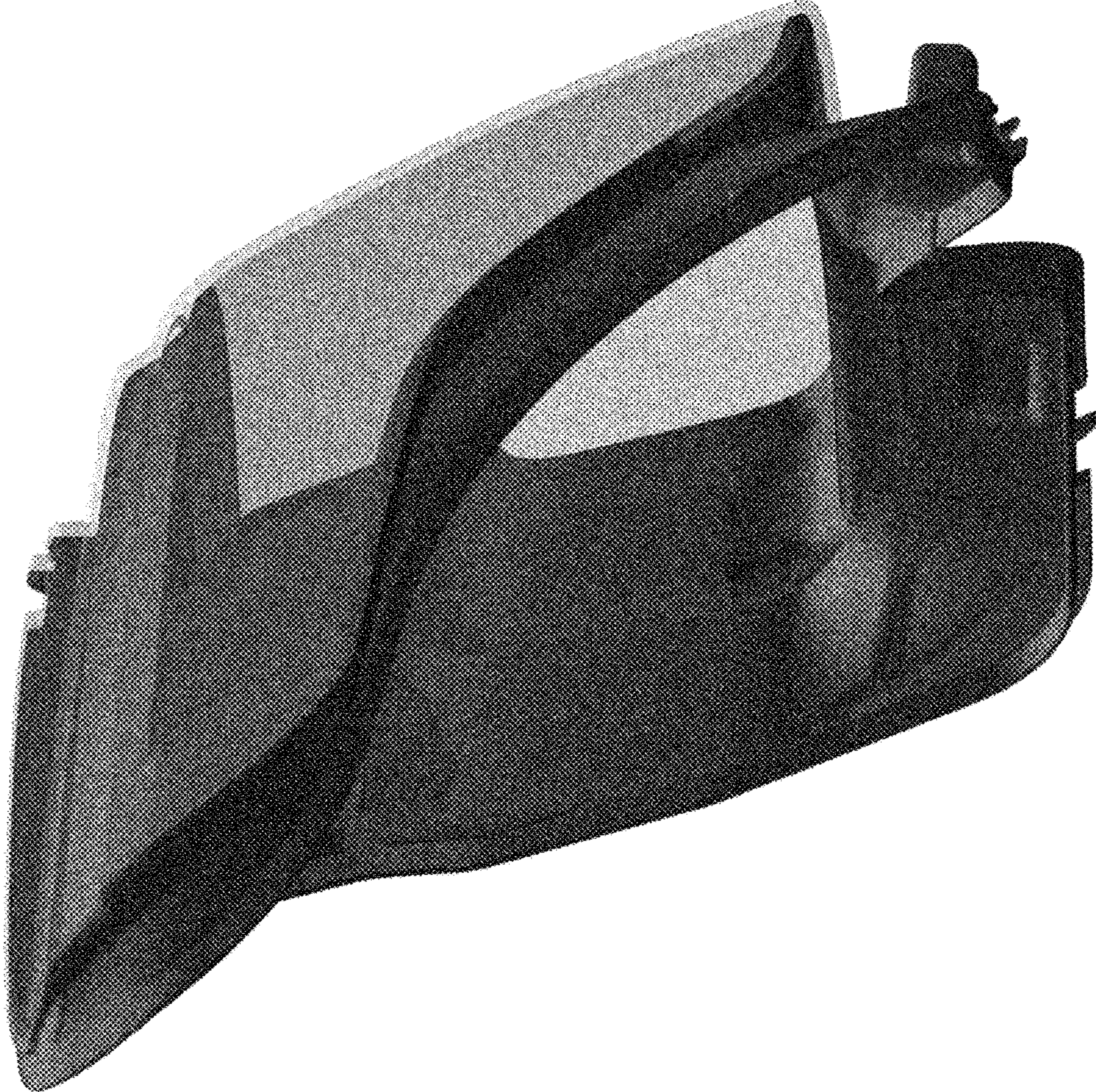

FIG. 4

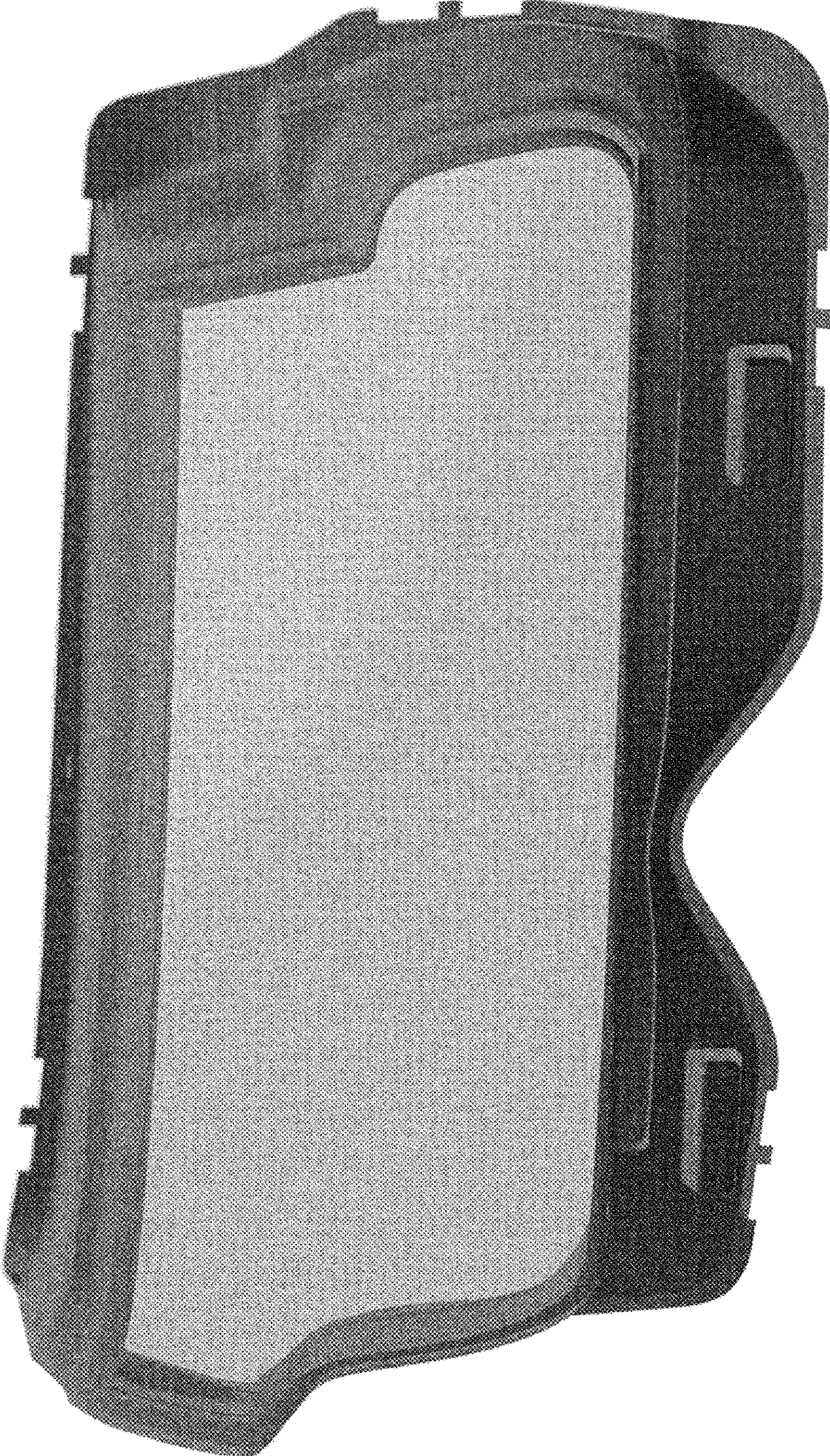

FIG. 5

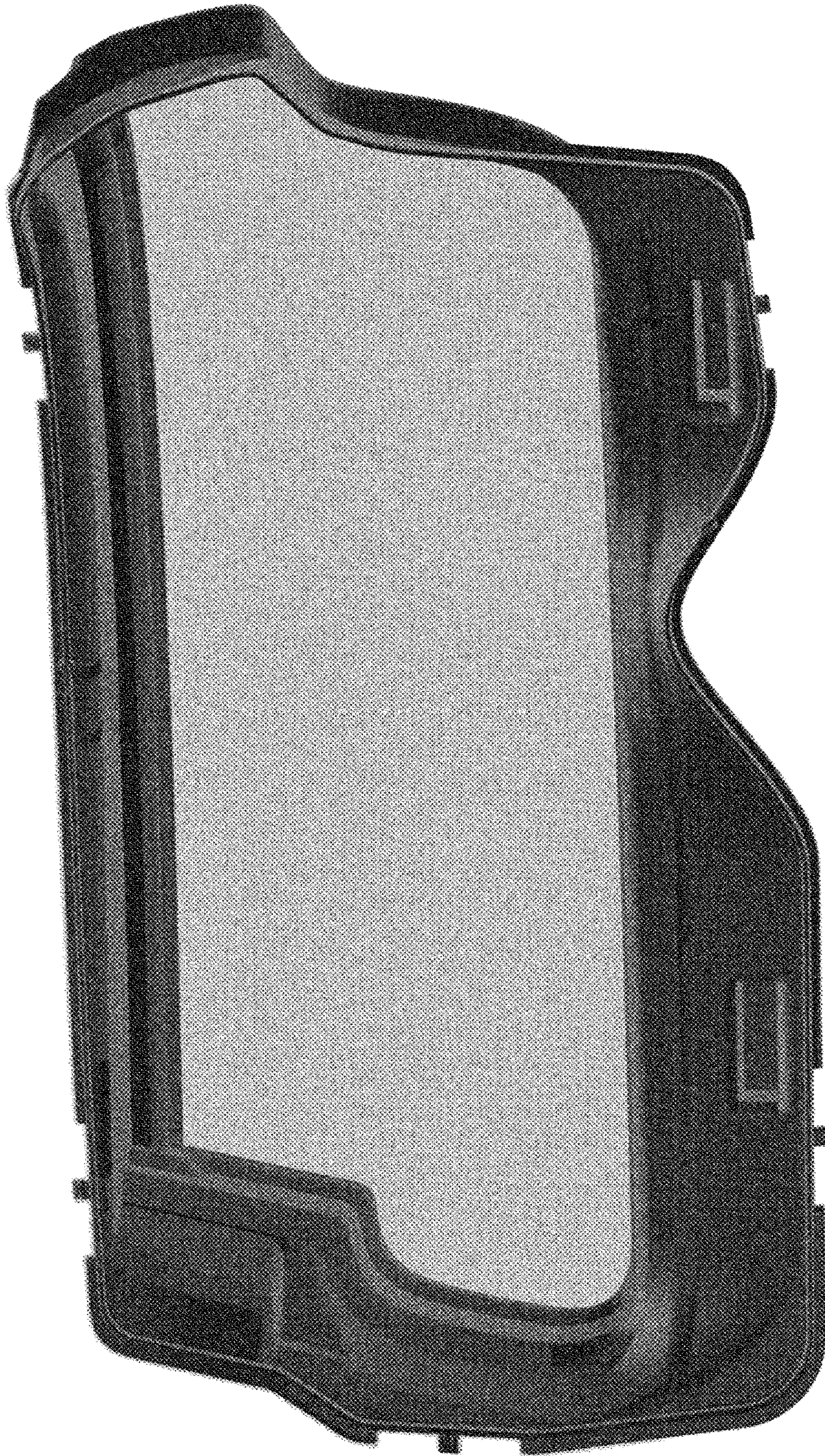

FIG. 6

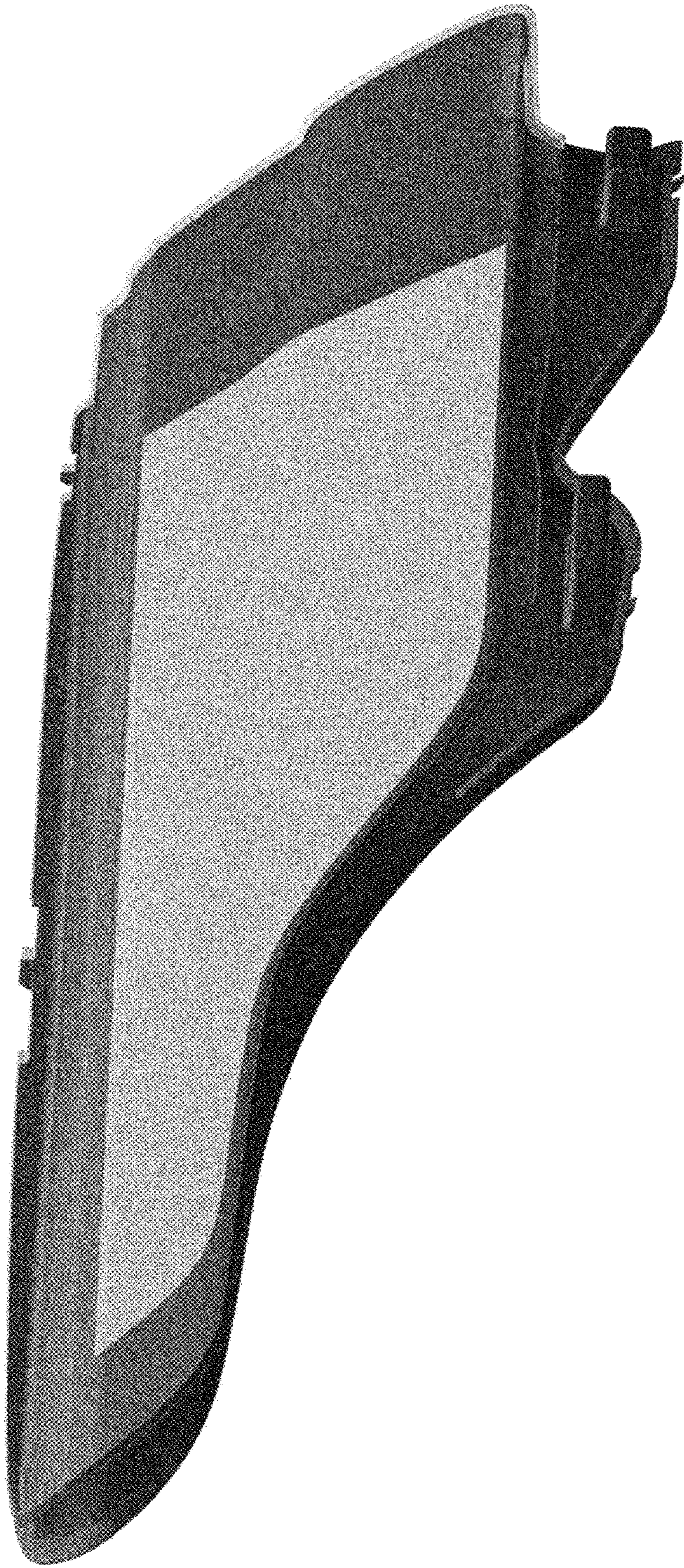

FIG. 7

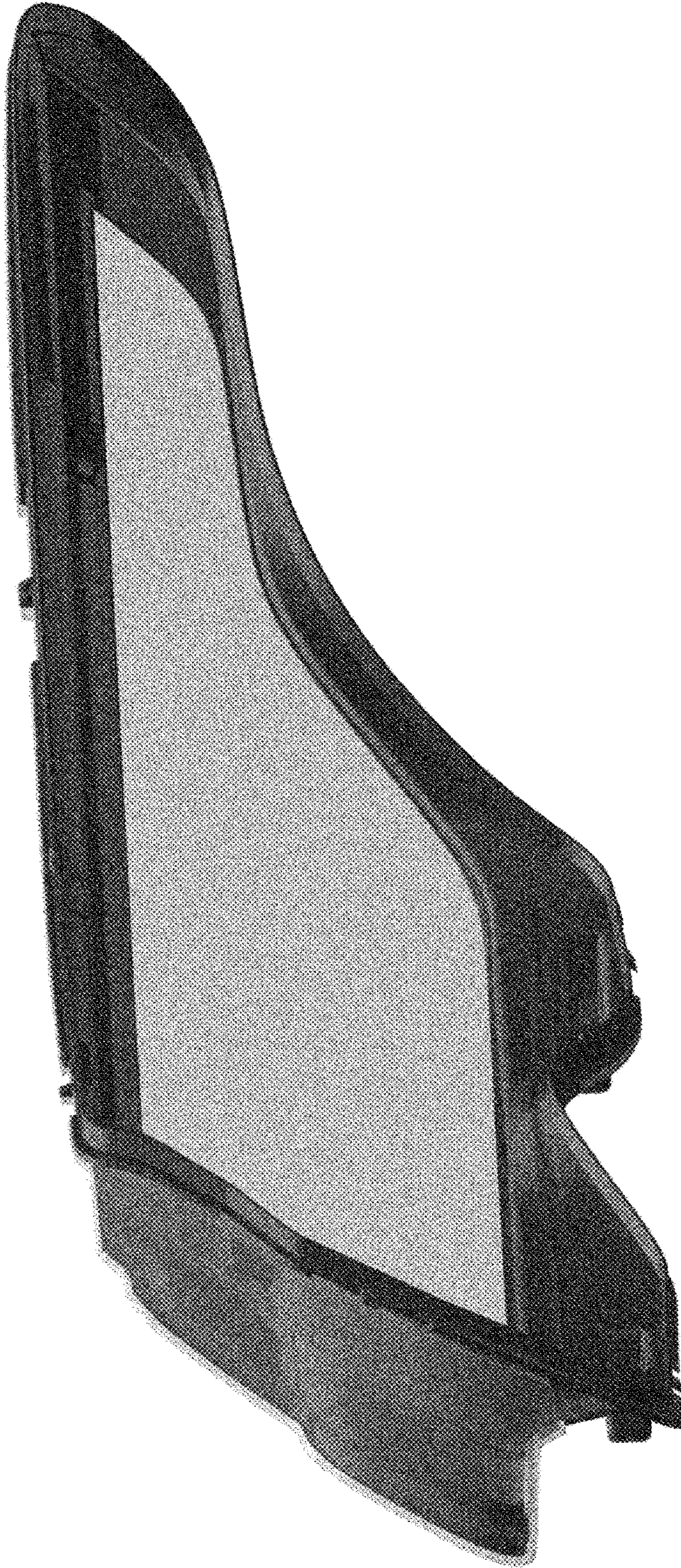

FIG. 8



FIG. 9



FIG. 10