



US00D837322S

(12) **United States Design Patent**
Desberg

(10) **Patent No.:** **US D837,322 S**
(45) **Date of Patent:** **** Jan. 1, 2019**

- (54) **TWO WHEELED BOARD**
- (71) Applicant: **RAZOR USA LLC**, Cerritos, CA (US)
- (72) Inventor: **Ian Desberg**, Cerritos, CA (US)
- (73) Assignee: **RAZOR USA LLC**, Cerritos, CA (US)
- (**) Term: **15 Years**
- (21) Appl. No.: **29/627,176**
- (22) Filed: **Nov. 22, 2017**

4,624,469 A 11/1986 Bourne, Jr.
 4,712,806 A 12/1987 Patrin
 4,874,055 A 10/1989 Beer
 5,011,171 A 4/1991 Cook
 (Continued)

FOREIGN PATENT DOCUMENTS

CA 2903571 A1 12/2015
 CN 101148184 A 3/2008
 (Continued)

OTHER PUBLICATIONS

Alex Banks, Everything You Need to Know About the Hoverboard Craze, Highsnobiety.com, Oct. 14, 2015, <http://www.highsnobiety.com/2015/10/14/hoverboard-history>.
 (Continued)

Primary Examiner — Cynthia M. Chin
 (74) *Attorney, Agent, or Firm* — Knobbe Martens Olson & Bear, LLP

Related U.S. Application Data

- (62) Division of application No. 29/571,692, filed on Jul. 20, 2016, now Pat. No. Des. 803,963.
- (51) **LOC (11) Cl.** **21-02**
- (52) **U.S. Cl.**
USPC **D21/760**
- (58) **Field of Classification Search**
USPC D21/419, 421, 423, 426, 760, 765, 766, D21/769, 771, 776, 803; D12/1
CPC A63C 17/01; A63C 17/12; A63C 2203/00; A63C 2203/011; A63C 2203/012; A63C 2203/013; A63C 2203/40; A63C 2203/52; B62D 51/02; B62K 2202/00; B62K 2207/00; B62K 2207/02; B62K 2207/04
See application file for complete search history.

(57) **CLAIM**

The ornamental design for a two wheeled board, as shown and described.

DESCRIPTION

FIG. 1 is a front, top, left-side perspective view of a two wheeled board of our design;
 FIG. 2 is a rear, bottom, left-side perspective view thereof;
 FIG. 3 is a top view thereof;
 FIG. 4 is a bottom view thereof;
 FIG. 5 is a front view thereof;
 FIG. 6 is a rear view thereof;
 FIG. 7 is a left-side view thereof; and,
 FIG. 8 is a right-side view thereof.
 The broken lines are for the purpose of illustrating portions of the article that form no part of the claim.

1 Claim, 7 Drawing Sheets

(56) **References Cited**

U.S. PATENT DOCUMENTS

3,860,264 A 1/1975 Douglas et al.
 4,065,146 A 12/1977 Denzer
 4,076,270 A 2/1978 Winchell
 4,151,892 A 5/1979 Francken
 4,281,734 A 8/1981 Johnston
 4,325,565 A 4/1982 Winchell
 4,354,569 A 10/1982 Eichholz
 4,484,648 A 11/1984 Jephcott
 4,556,997 A 12/1985 Takamiya et al.

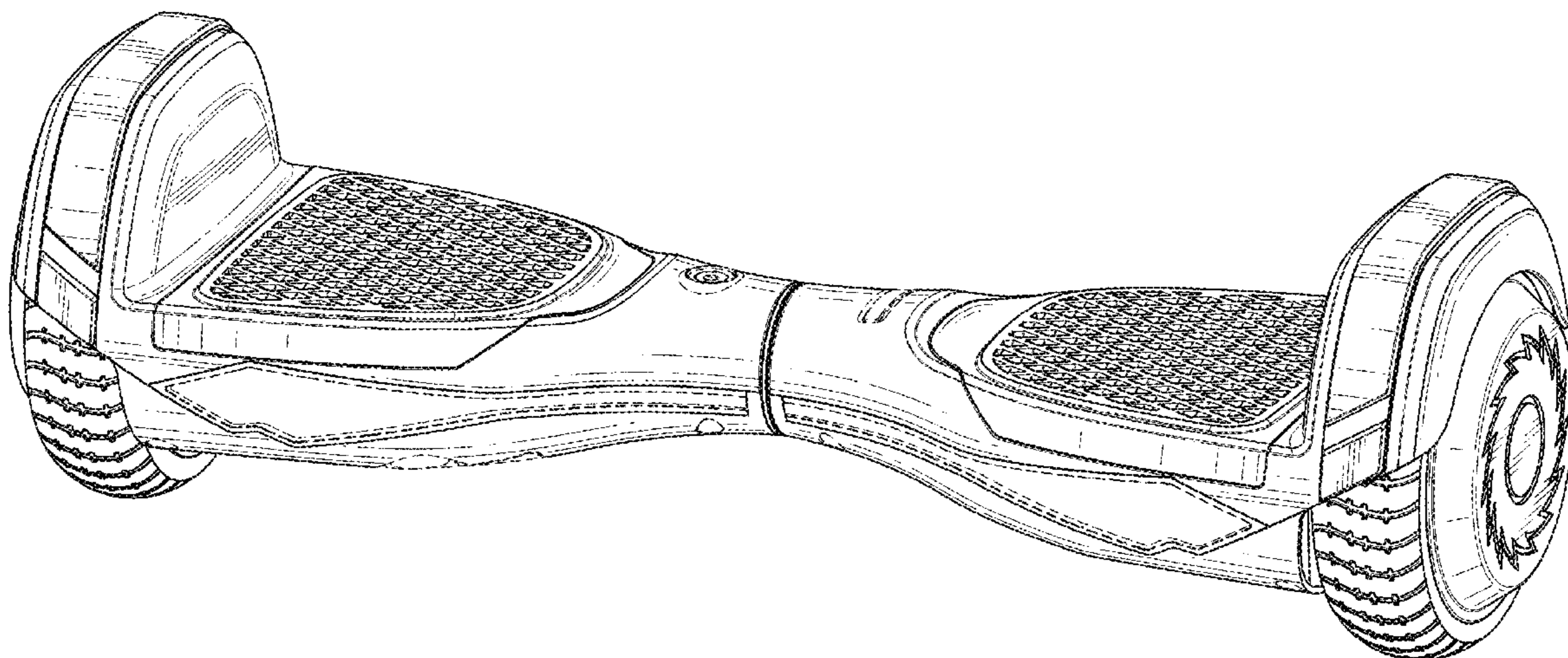

(56)

References Cited

U.S. PATENT DOCUMENTS

5,165,711 A	11/1992	Tsai	7,130,702 B2	10/2006	Morrell
D355,148 S	2/1995	Orsolini	7,131,706 B2	11/2006	Kamen et al.
5,522,568 A	6/1996	Kamen et al.	7,157,875 B2	1/2007	Kamen et al.
5,571,892 A	11/1996	Fuji et al.	7,174,976 B2	2/2007	Kamen et al.
5,695,021 A	12/1997	Schaffner et al.	7,178,614 B2	2/2007	Ishii
5,701,965 A	12/1997	Kamen et al.	7,182,166 B2	2/2007	Gray et al.
5,701,968 A	12/1997	Wright-Ott et al.	7,210,544 B2	5/2007	Kamen et al.
5,775,452 A	7/1998	Patmont	7,243,572 B1	7/2007	Arling et al.
5,791,425 A	8/1998	Kamen et al.	7,263,453 B1	8/2007	Gansler et al.
5,794,730 A	8/1998	Kamen	D551,592 S	9/2007	Chang et al.
5,848,660 A	12/1998	McGreen	D551,722 S	9/2007	Chang et al.
5,971,091 A	10/1999	Kamen et al.	7,273,116 B2	9/2007	Kamen et al.
5,975,225 A	11/1999	Kamen et al.	7,275,607 B2	10/2007	Kamen et al.
6,050,357 A	4/2000	Staelin et al.	7,303,032 B2	12/2007	Kahlert et al.
6,052,647 A	4/2000	Parkinson et al.	7,338,056 B2	3/2008	Chen et al.
6,062,600 A	5/2000	Kamen et al.	7,357,202 B2	4/2008	Kamen et al.
6,223,104 B1	4/2001	Kamen et al.	7,363,993 B2	4/2008	Ishii
D444,184 S	6/2001	Kettler	7,367,572 B2	5/2008	Jiang
6,273,212 B1	8/2001	Husted et al.	7,370,713 B1	5/2008	Kamen
6,288,505 B1	9/2001	Heinzmann et al.	7,407,175 B2	8/2008	Kamen et al.
6,302,230 B1	10/2001	Kamen et al.	7,437,202 B2	10/2008	Morrell
6,332,103 B1	12/2001	Steenon et al.	7,469,760 B2	12/2008	Kamen et al.
6,357,544 B1	3/2002	Kamen et al.	7,479,872 B2	1/2009	Kamen et al.
6,367,817 B1	4/2002	Kamen et al.	7,481,291 B2	1/2009	Nishikawa
6,386,576 B1	5/2002	Kamen et al.	7,546,889 B2	6/2009	Kamen et al.
6,405,816 B1	6/2002	Kamen et al.	7,592,900 B2	9/2009	Kamen et al.
6,408,240 B1	6/2002	Morrell et al.	D601,922 S	10/2009	Imai et al.
6,415,879 B2	7/2002	Kamen et al.	7,690,447 B2	4/2010	Kamen et al.
6,435,535 B1	8/2002	Field et al.	7,690,452 B2	4/2010	Kamen et al.
6,443,250 B1	9/2002	Kamen et al.	7,703,568 B2	4/2010	Ishii
6,538,411 B1	3/2003	Field et al.	7,708,094 B2	5/2010	Kamen et al.
6,543,564 B1	4/2003	Kamen et al.	7,740,099 B2	6/2010	Field et al.
6,547,026 B2	4/2003	Kamen et al.	7,757,794 B2	7/2010	Heinzmann
6,553,271 B1	4/2003	Morrell	7,779,939 B2	8/2010	Kamen et al.
6,561,294 B1	5/2003	Kamen et al.	7,783,392 B2	8/2010	Oikawa
6,575,539 B2	6/2003	Reich	7,789,174 B2	9/2010	Kamen et al.
6,581,714 B1	6/2003	Kamen et al.	7,812,715 B2	10/2010	Kamen et al.
6,598,941 B2	7/2003	Field et al.	7,857,088 B2	12/2010	Field et al.
6,651,763 B1	11/2003	Kamen et al.	7,900,725 B2	3/2011	Heinzmann et al.
6,651,766 B2	11/2003	Kamen et al.	7,938,207 B2	5/2011	Kamen et al.
D489,027 S	4/2004	Waters	7,950,123 B2	5/2011	Arling et al.
D489,029 S	4/2004	Waters	7,962,256 B2	6/2011	Sterns et al.
6,715,845 B2	4/2004	Kamen et al.	7,979,179 B2	7/2011	Gansler
D489,300 S	5/2004	Chang et al.	8,014,923 B2	9/2011	Ishii et al.
D493,127 S	7/2004	Waters et al.	8,028,777 B2	10/2011	Kakinuma et al.
D493,128 S	7/2004	Waters et al.	8,047,556 B2	11/2011	Jang et al.
D493,129 S	7/2004	Waters et al.	8,074,388 B2	12/2011	Trainer
D493,392 S	7/2004	Waters et al.	8,091,672 B2	1/2012	Gutsch et al.
D494,099 S	8/2004	Maurer et al.	8,146,696 B2	4/2012	Kaufman
6,779,621 B2	8/2004	Kamen et al.	8,162,089 B2	4/2012	Shaw
6,789,640 B1	9/2004	Arling et al.	8,170,780 B2	5/2012	Field et al.
6,796,396 B2	9/2004	Kamen et al.	8,186,462 B2	5/2012	Kamen et al.
6,799,649 B2	10/2004	Kamen et al.	8,225,891 B2	7/2012	Takenaka et al.
6,815,919 B2	11/2004	Field et al.	8,248,222 B2	8/2012	Kamen et al.
6,827,163 B2	12/2004	Amsbury et al.	8,322,477 B2	12/2012	Kamen et al.
6,837,327 B2	1/2005	Heinzmann	8,417,404 B2	4/2013	Yen et al.
6,866,107 B2	3/2005	Heinzmann et al.	8,453,340 B2	6/2013	Van der Merwe et al.
6,868,931 B2	3/2005	Morrell et al.	8,453,768 B2	6/2013	Kamen et al.
6,874,591 B2	4/2005	Morrell et al.	8,467,941 B2	6/2013	Field et al.
6,889,784 B2	5/2005	Troll	8,490,723 B2	7/2013	Heinzmann et al.
6,907,949 B1	6/2005	Wang	8,532,877 B2	9/2013	Oikawa
D507,206 S	7/2005	Wang	8,584,782 B2	11/2013	Chen
6,920,947 B2	7/2005	Kamen et al.	8,684,123 B2	4/2014	Chen
6,929,080 B2	8/2005	Kamen et al.	8,688,303 B2	4/2014	Stevens et al.
6,965,206 B2	11/2005	Kamen et al.	8,738,278 B2	5/2014	Chen
6,969,079 B2	11/2005	Kamen et al.	8,807,250 B2	8/2014	Chen
6,992,452 B1	1/2006	Sachs et al.	8,830,048 B2	9/2014	Kamen et al.
7,000,933 B2	2/2006	Arling et al.	8,860,362 B2	10/2014	Kamen et al.
7,004,271 B1	2/2006	Kamen et al.	8,978,791 B2	3/2015	Ha et al.
7,006,901 B2	2/2006	Wang	9,045,190 B2	6/2015	Chen
7,017,686 B2	3/2006	Kamen et al.	D737,723 S	9/2015	Ying et al.
7,023,330 B2	4/2006	Kamen et al.	D738,256 S	9/2015	Ying et al.
7,090,040 B2	8/2006	Kamen et al.	D739,906 S	9/2015	Chen
7,091,724 B2	8/2006	Heinzmann et al.	9,376,155 B2	6/2016	Ying et al.
D528,468 S	9/2006	Arling et al.	9,403,573 B1	8/2016	Mazzei
			9,452,802 B2	9/2016	Ying et al.
			D778,782 S	2/2017	Chen et al.
			D779,375 S	2/2017	Zeng
			D780,626 S	3/2017	Li et al.

(56)

References Cited

U.S. PATENT DOCUMENTS

D783,452 S 4/2017 Ying
 D783,751 S 4/2017 Yao
 D784,195 S 4/2017 Ying
 D784,196 S 4/2017 Ying
 D784,197 S 4/2017 Ying
 D784,198 S 4/2017 Zhu
 D785,112 S 4/2017 Ying
 D785,113 S 4/2017 Ying
 D785,114 S 4/2017 Ying
 D785,115 S 4/2017 Ying
 D785,736 S 5/2017 Ying
 D786,130 S 5/2017 Huang
 D786,994 S 5/2017 Chen
 D803,722 S 11/2017 Ying
 D803,963 S 11/2017 Desberg
 D805,429 S 12/2017 Cao
 9,840,302 B2 12/2017 Zeng
 D807,457 S 1/2018 Desberg
 D808,300 S * 1/2018 Cao D12/1
 D808,855 S * 1/2018 Zhang D12/1
 D808,856 S * 1/2018 Zhang D12/1
 D808,857 S 1/2018 Zhang
 D810,618 S * 2/2018 Li D12/1
 D812,521 S 3/2018 Yao
 2002/0063006 A1 5/2002 Kamen et al.
 2002/0149172 A1 10/2002 Field et al.
 2004/0005958 A1 1/2004 Kamen et al.
 2004/0007399 A1 1/2004 Heinzmann et al.
 2004/0007644 A1 1/2004 Phelps, III et al.
 2004/0055796 A1 1/2004 Heinzmann et al.
 2004/0050611 A1 3/2004 Kamen et al.
 2004/0201271 A1 10/2004 Kakinuma et al.
 2004/0262871 A1 12/2004 Schreuder et al.
 2005/0126832 A1 6/2005 Amsbury et al.
 2005/0134014 A1 6/2005 Xie
 2006/0202439 A1 9/2006 Kahlert et al.
 2006/0260857 A1 11/2006 Kakinuma et al.
 2007/0051543 A1 3/2007 Kamen et al.
 2008/0105471 A1 1/2008 Nakashima et al.
 2008/0029985 A1 2/2008 Chen
 2008/0147281 A1 6/2008 Ishii et al.
 2008/0284130 A1 11/2008 Kamen et al.
 2009/0032323 A1 2/2009 Kakinuma et al.
 2009/0055033 A1 2/2009 Gansler et al.
 2009/0078485 A1 3/2009 Gutsch et al.
 2009/0105908 A1 4/2009 Casey et al.
 2010/0025139 A1 2/2010 Kosaka et al.
 2010/0033315 A1 2/2010 Kamen et al.
 2010/0114468 A1 5/2010 Field et al.
 2010/0121538 A1 5/2010 Ishii et al.
 2010/0207564 A1 8/2010 Robinson
 2010/0217497 A1 8/2010 Kamen et al.
 2010/0222994 A1 9/2010 Field et al.
 2010/0225080 A1 9/2010 Smith
 2010/0237645 A1 9/2010 Trainer
 2011/0209929 A1 9/2011 Heinzmann et al.
 2011/0220427 A1 9/2011 Heinzmann et al.
 2011/0221160 A1 9/2011 Shaw et al.
 2011/0238247 A1 9/2011 Yen et al.
 2012/0205176 A1 8/2012 Ha et al.
 2012/0239284 A1 9/2012 Field et al.
 2012/0290162 A1 11/2012 Stevens et al.
 2012/0310464 A1 12/2012 Kamen et al.
 2013/0010825 A1 1/2013 Kamen et al.
 2013/0032422 A1 2/2013 Chen
 2013/0032423 A1 2/2013 Chen
 2013/0092461 A1 4/2013 Kamen et al.
 2013/0099565 A1 4/2013 Sachs et al.
 2013/0105239 A1 5/2013 Fung
 2013/0228385 A1 9/2013 Chen
 2013/0238231 A1 * 9/2013 Chen B62K 3/007
 701/124
 2013/0268145 A1 10/2013 Kamen et al.
 2014/0091622 A1 4/2014 Lucas et al.
 2014/0163855 A1 6/2014 Field et al.

2014/0188316 A1 7/2014 Heinzmann et al.
 2014/0222267 A1 8/2014 Stevens et al.
 2014/0339003 A1 11/2014 Kamen et al.
 2015/0096820 A1 4/2015 Strack
 2016/0129963 A1 5/2016 Ying et al.
 2016/0207584 A1 7/2016 Ying et al.
 2016/0325803 A1 11/2016 Waxman
 2017/0144718 A1 5/2017 Tinaphong
 2017/0158275 A1 6/2017 Yang
 2017/0166278 A1 6/2017 Lu
 2017/0183053 A1 6/2017 Zeng
 2017/0217529 A1 8/2017 Chen
 2017/0297653 A1 10/2017 Zheng
 2018/0037290 A1 2/2018 Ying
 2018/0037293 A1 2/2018 Chen

FOREIGN PATENT DOCUMENTS

CN 101157376 A 4/2008
 CN 101920728 12/2010
 CN 101565073 B 1/2011
 CN 201824899 U 5/2011
 CN 102602481 A 7/2012
 CN 203158157 U 8/2013
 CN 203381739 U 1/2014
 CN 104014123 A 9/2014
 CN 104029769 A 9/2014
 CN 203844875 U 9/2014
 CN 203996649 U 12/2014
 CN 204050913 U 12/2014
 CN 102514662 B 4/2015
 CN 102514663 B 5/2015
 CN 104859773 A 8/2015
 CN 104922891 A 9/2015
 CN 104922893 A 9/2015
 CN 104954476 A 9/2015
 CN 105151181 A 12/2015
 CN 204864865 U 12/2015
 CN 204952213 U 1/2016
 CN 205005082 U 1/2016
 CN 105329387 A 2/2016
 CN 105329388 A 2/2016
 CN 105346606 A 2/2016
 CN 105346607 A 2/2016
 CN 105346643 A 2/2016
 CN 105346649 A 2/2016
 CN 105346650 A 2/2016
 CN 105346651 A 2/2016
 CN 105416464 A 3/2016
 CN 105416484 A 3/2016
 CN 105416485 A 3/2016
 CN 105416486 A 3/2016
 CN 205150007 U 4/2016
 CN 205150114 U 4/2016
 CN 205160428 U 4/2016
 CN 205186320 U 4/2016
 CN 205186321 U 4/2016
 CN 205186322 U 4/2016
 CN 105539664 A 5/2016
 CN 105539665 A 5/2016
 CN 105539666 A 5/2016
 CN 105539695 A 5/2016
 DE 3411489 10/1984
 DE 44 04 594 8/1995
 DE 10209093 9/2003
 DE 202014010564 U1 1/2016
 EP 2987712 A1 2/2016
 GB 2529565 A 2/2016
 JP 52-044933 4/1977
 JP 57-87766 6/1982
 JP 57-110569 7/1982
 JP 59-73372 4/1984
 JP 61-31685 2/1986
 JP 62-12810 1/1987
 JP 63-305082 6/1987
 JP 2-190277 7/1990
 JP 4-201793 7/1992
 JP 5-213240 8/1993
 JP 6-105415 4/1994

(56)

References Cited

FOREIGN PATENT DOCUMENTS

JP	6-171562	6/1994
JP	10-023613	1/1998
JP	H03-070015	5/2000
JP	2006-001384 A	1/2006
JP	2010-254216 A	11/2010
TW	M516550 U	2/2016
WO	WO 86/05752	10/1986
WO	WO 89/06117	7/1989
WO	WO 96/23478	8/1996
WO	WO 98/46474	10/1998
WO	WO 00/75001	12/2000
WO	WO 2003/68342	2/2003
WO	WO 2004/07264	1/2004
WO	WO 2015/188599 A1	12/2015

OTHER PUBLICATIONS

John D. Bash, How Do Self Balancing Scooters Work?, Bestelectrichoverboard.com (Nov. 12, 2015), <https://bestelectrichoverboard.com/hoverboard-faq/how-do-selfbalancing-scooters-work/>.

Blankespoor et al., Experimental Verification of the Dynamic Model for a Quarter Size Self-Balancing Wheelchair, Proceeding of the 2004 American Control Conference, Boston, MA, vol. 1, pp. 488-492.

CNET, Screenshots of "First look at the Razor Hovertrax 2.0 with Jake Krol" video, posted on Jul. 13, 2016, in 28 pages.

Ben Detrick, Celebrities on Scooters (Catch Them If You Can), the New York Times Aug. 15, 2015, http://www.nytimes.com/2015/08/16/fashion/cara-delevingne-justinbieber-meek-mill-stephen-curry-on-scooters.html?_r=%200.

Hu et al., Self-balancing Control and Manipulation of a Glove Puppet Robot on a Two-Wheel Mobile Platform, 2009 IEEE/RSJ International Conference on intelligent Robots and Systems, St. Louis, MO, 2009, pp. 424-425.

IO Hawk—Intelligent Personal Mobility Device, <https://web.archive.org/web/20150718144409/http://iohawk.com>, Jul. 18, 2015, in 9 pages.

Inventist, Inc. "Hovertrax Guide and Manual," 2014, in 15 pages. "Inventist Inc , Solo Wheel , Orbit wheel @ Toy Fair 2013" <https://www.youtube.com/watch?v=w8rHKCjLAWI>, Feb. 10, 2013.

Alex Kantrowitz, Everything You Need to Know About the Hoverboard Craze, Buzzfeed.com Aug. 27, 2015, https://www.buzzfeed.com/alexkantrowitz/a-crash-course-inhoverboards?utm_term=.qw5Z9x47Z#.oc1W1v56W.

Kawaji, S., Stabilization of Unicycle Using Spinning Motion, Denki Gakkai Ronbunshi, D, vol. 107, Issue 1, Japan (1987), pp. 21-28.

Kickstarter, Comments on Hovertrax by Inventist, <https://www.kickstarter.com/projects/687658339/hovertrax/comments>, apparently available Oct. 2014, in 16 pages.

Kickstarter, "Hovertrax by Inventist," <https://web.archive.org/web/20130504083823/http://kickstarter.com/projects/687658339/hovertrax?>, May 4, 2013, in 11 pages.

Kim et al., Development of a Two-Wheeled Mobile Tilting & Balancing (MTB) Robot, 2011 11th International Conference on Control, Automation and Systems (ICCAS), Gyeonggi-do, 2011, pp. 1-6.

Li et al., A coaxial couple wheeled equilibrium robot with T-S fuzzy equilibrium control, Industrial Robot: An International Journal, vol. 38, Issue 3, pp. 292-300, 2011.

Mike Murphy, Everything You've Ever Wanted to Know About the Hoverboard Craze, Quartz Nov. 11, 2015, <http://qz.com/495935/everything-youve-ever-wanted-to-know-aboutthe-hoverboard-craze/>.

Mandy Robinson, Hoverboard Black Friday Sales: Best Places to Get One Before Christmas, Inquisitr.com, Nov. 24, 2015, <http://www.inquisitr.com/2589773/hoverboard-black-friday-sales-best-10107994-iv-places-to-get-one-before-christmas/>.

Sasaki et al., Forward and Backward Motion Control of Personal Riding-type Wheeled Mobile Platform, Proceedings of the 2004 IEEE International Conference on Robotics and Automation, vol. 4, pp. 3331-3336.

Sasaki, Makiko et al., "Steering Control of the Personal Riding-type Wheeled Mobile Platform (PMP)," vol. 4 of 4, IEEE, RSJ International Conference on Intelligent Robots and Systems, Aug. 2-6, 2005, in 60 pages.

Schoonwinkel, A, Design and Test of a Computer-Stabilized Unicycle, Stanford University (1988), UMI Dissertation Services.

Sino US Times, Interview of Mr. Ying, <http://www.chic-robot.com/index.php/news/info/54>, Jan. 26, 2016, in 15 pages.

Tsai et al., Development of a Self-Balancing Human Transportation Vehicle for the Teaching of Feedback Control, IEEE Transactions on Education, vol. 52, No. 1, Feb. 2009.

Vos D., Dynamics and Nonlinear Adaptive Control of an Autonomous Unicycle, Massachusetts Institute of Technology, 1989.

Vos, D., Nonlinear Control of an Autonomous Unicycle Robot: Practical Issues, Massachusetts Institute of Technology, 1992.

Georgia Wells, What It's Like to Have Wheels for Feet: Test Driving the Latest 'Hoverboards', The Wall Street Journal (Oct. 28, 2015), <http://www.wsj.com/articles/what-its-like-to-have-wheels-forfeet-test-driving-the-latest-hoverboards-1446055640>.

Yu et al., Development of a Omni-directional Self-Balancing Robot Wheelchair, Journal of Korea Robotics Society, vol. 8, Iss. 4, pp. 229-237 (2013).

'They're Completely Different Products': 10 Hawk President John Soibatian Not Concerned About Infringing Hovertrax Patent, Hoverguru.com (2015), <http://hoverguru.com/posts/theyrecompletely-different-products-io-hawk-president-john-soibatian-notconcerned-about-infringing-on-hovertrax-patent/> (last visited Dec. 27, 2016).

* cited by examiner

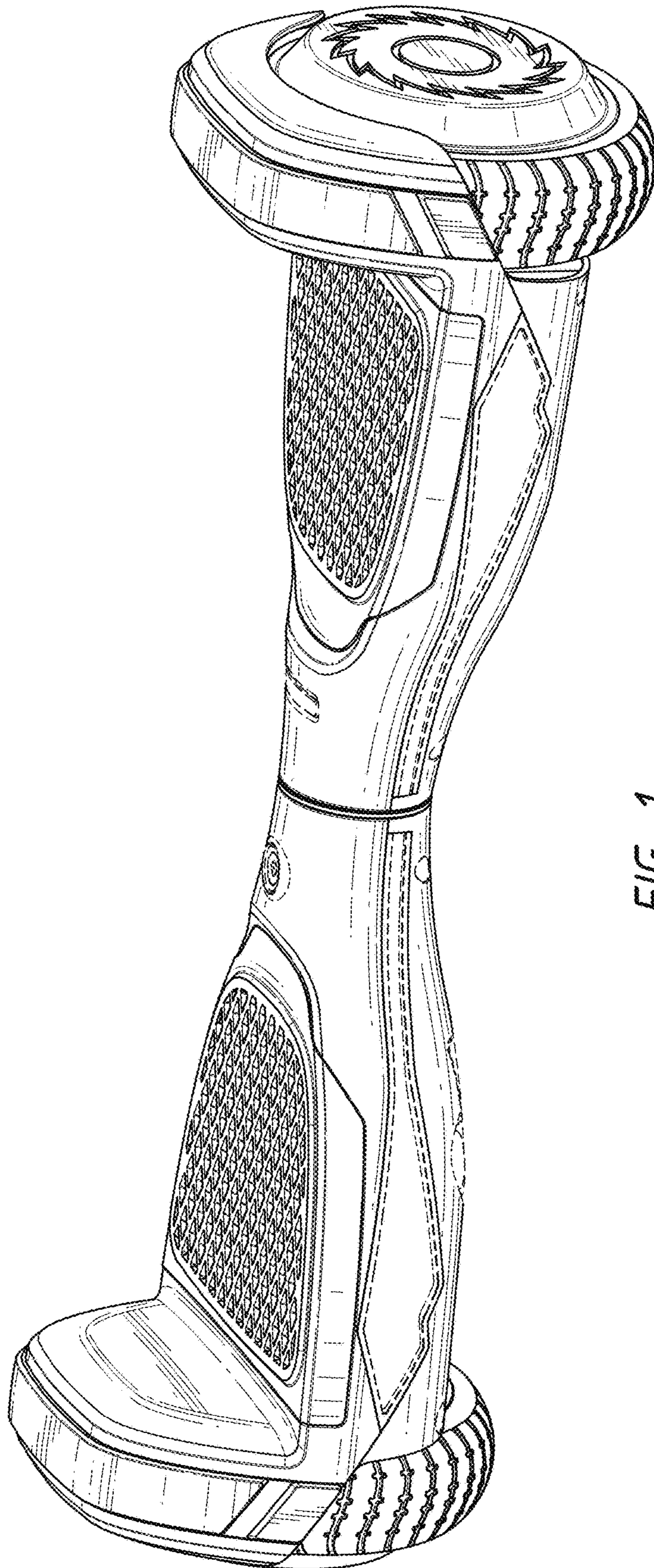

FIG. 1

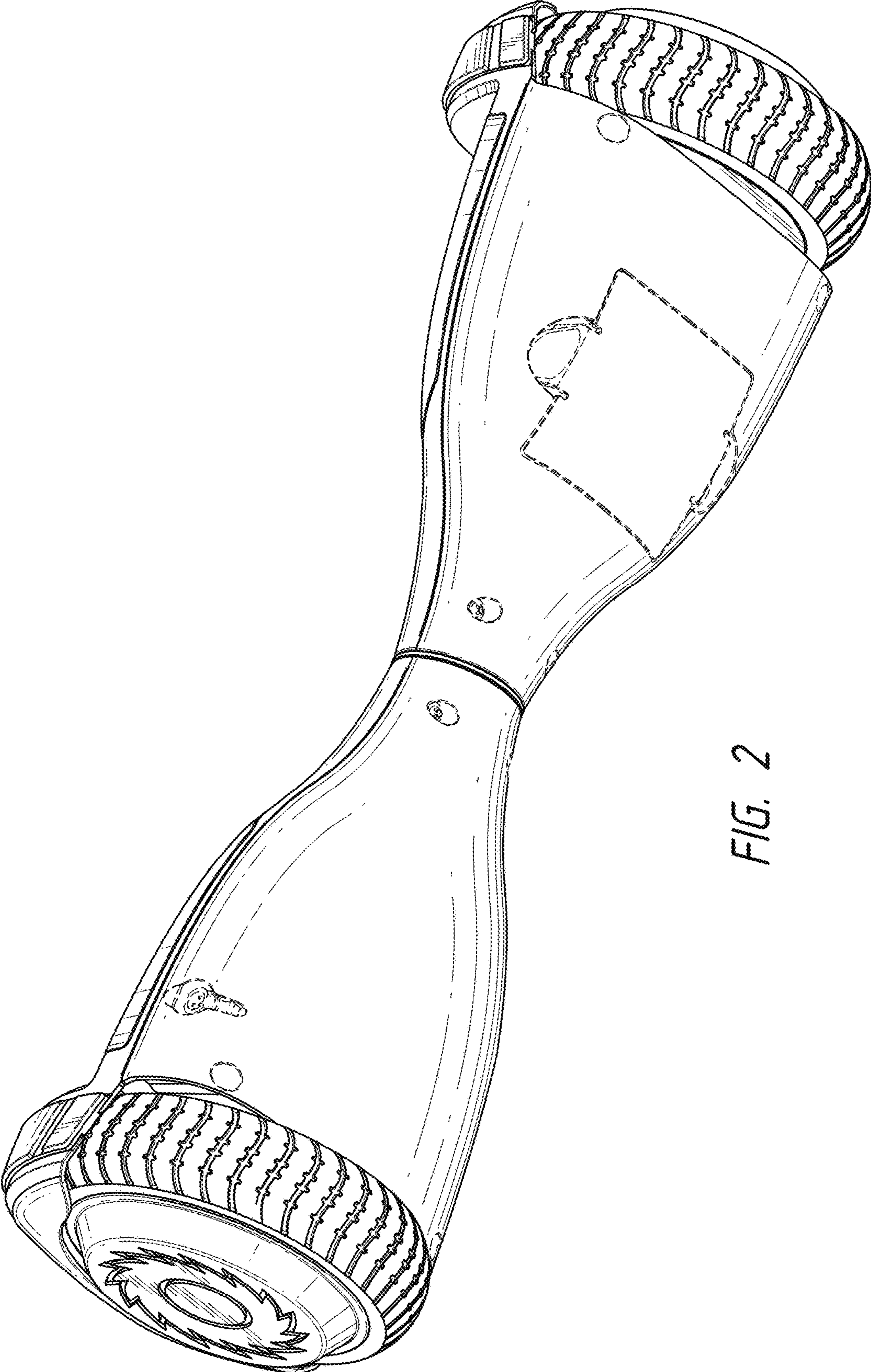

FIG. 2

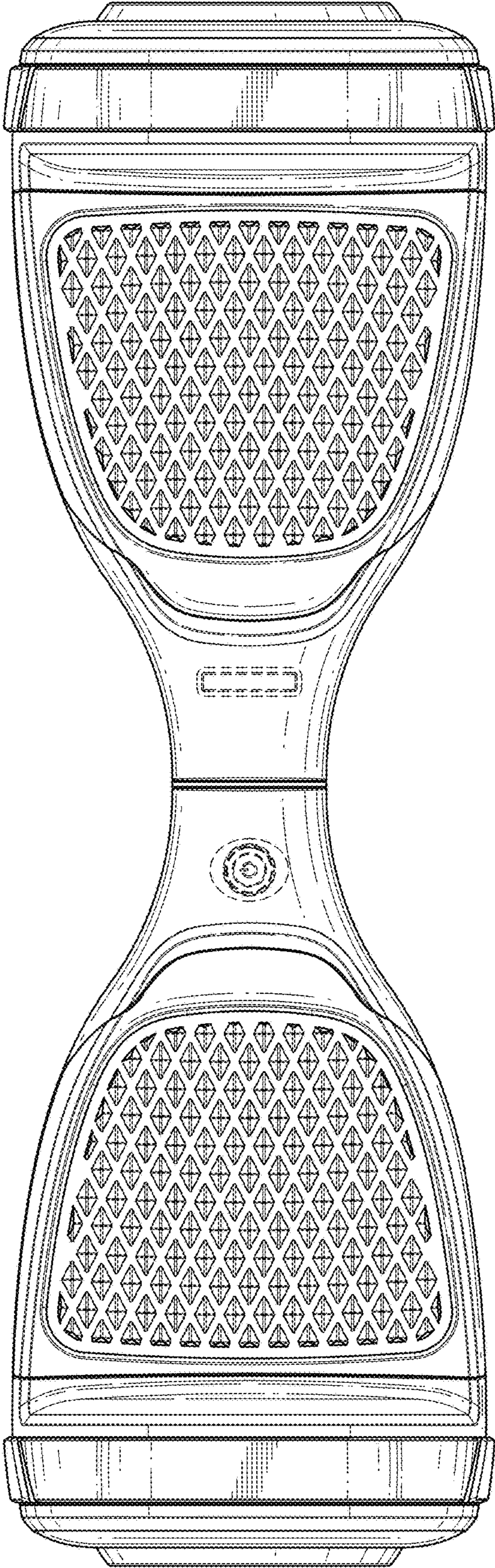

FIG. 3

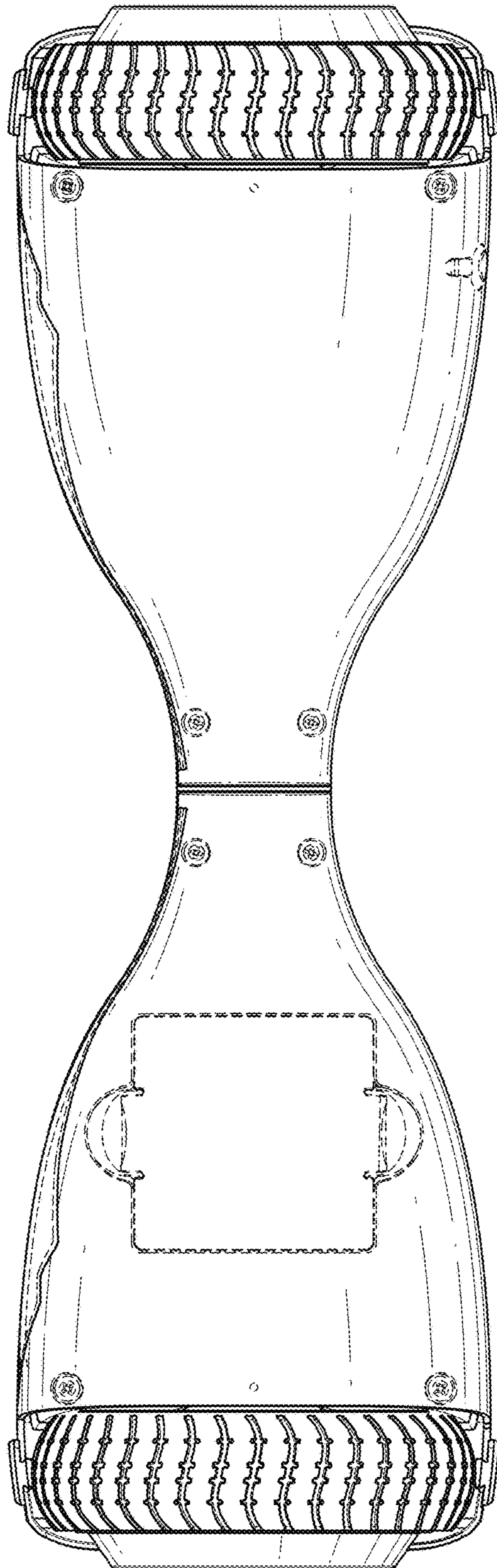

FIG. 4

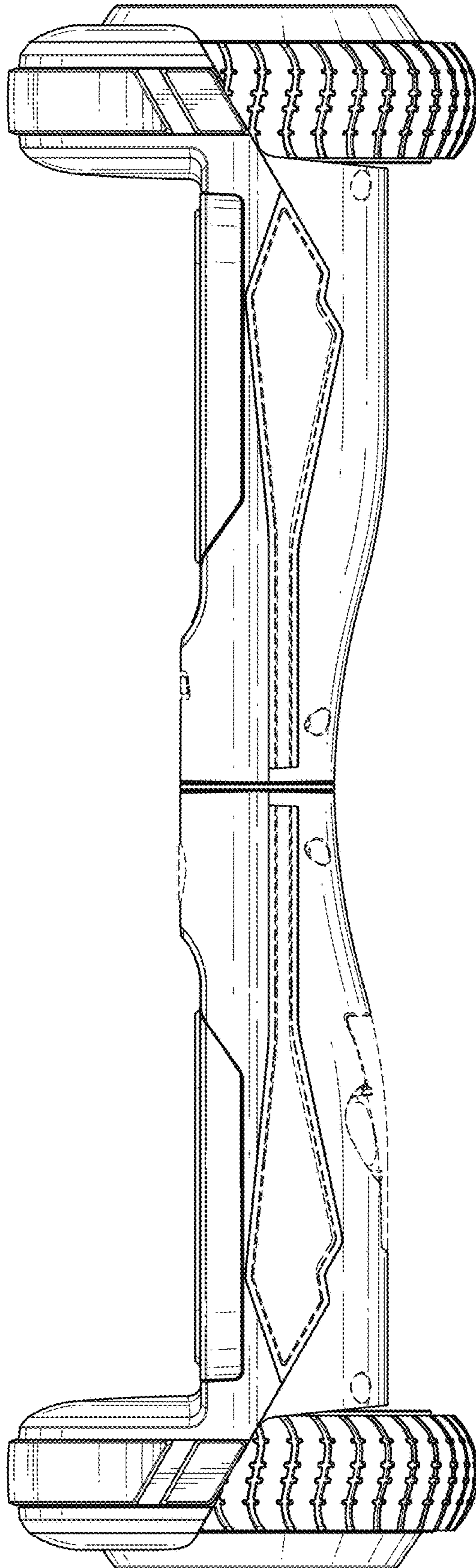

FIG. 5

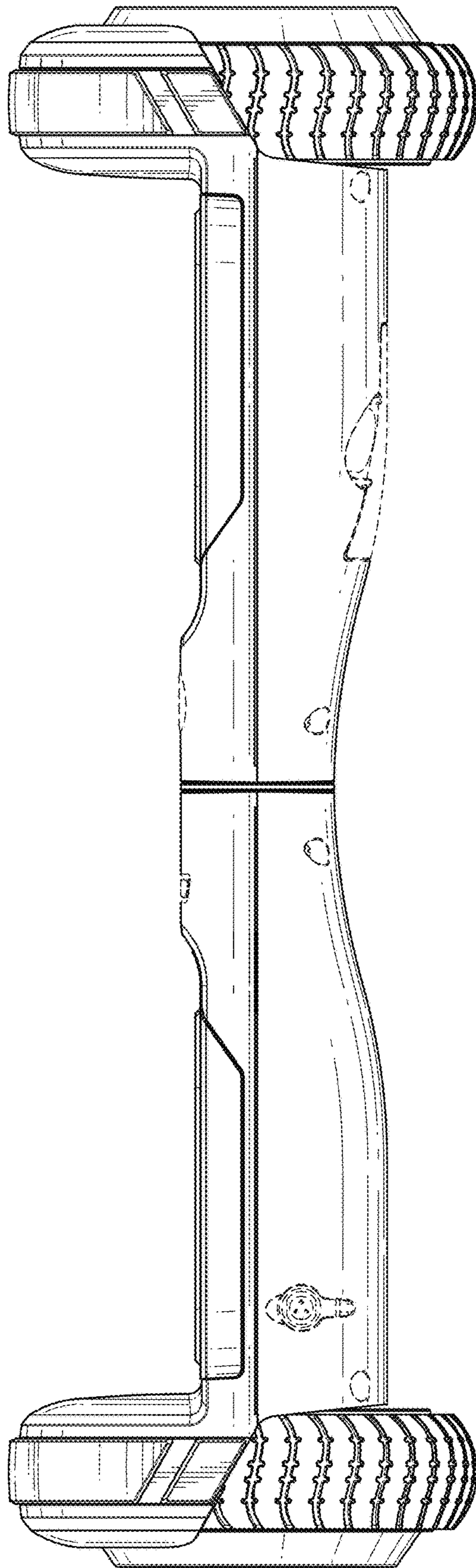

FIG. 6

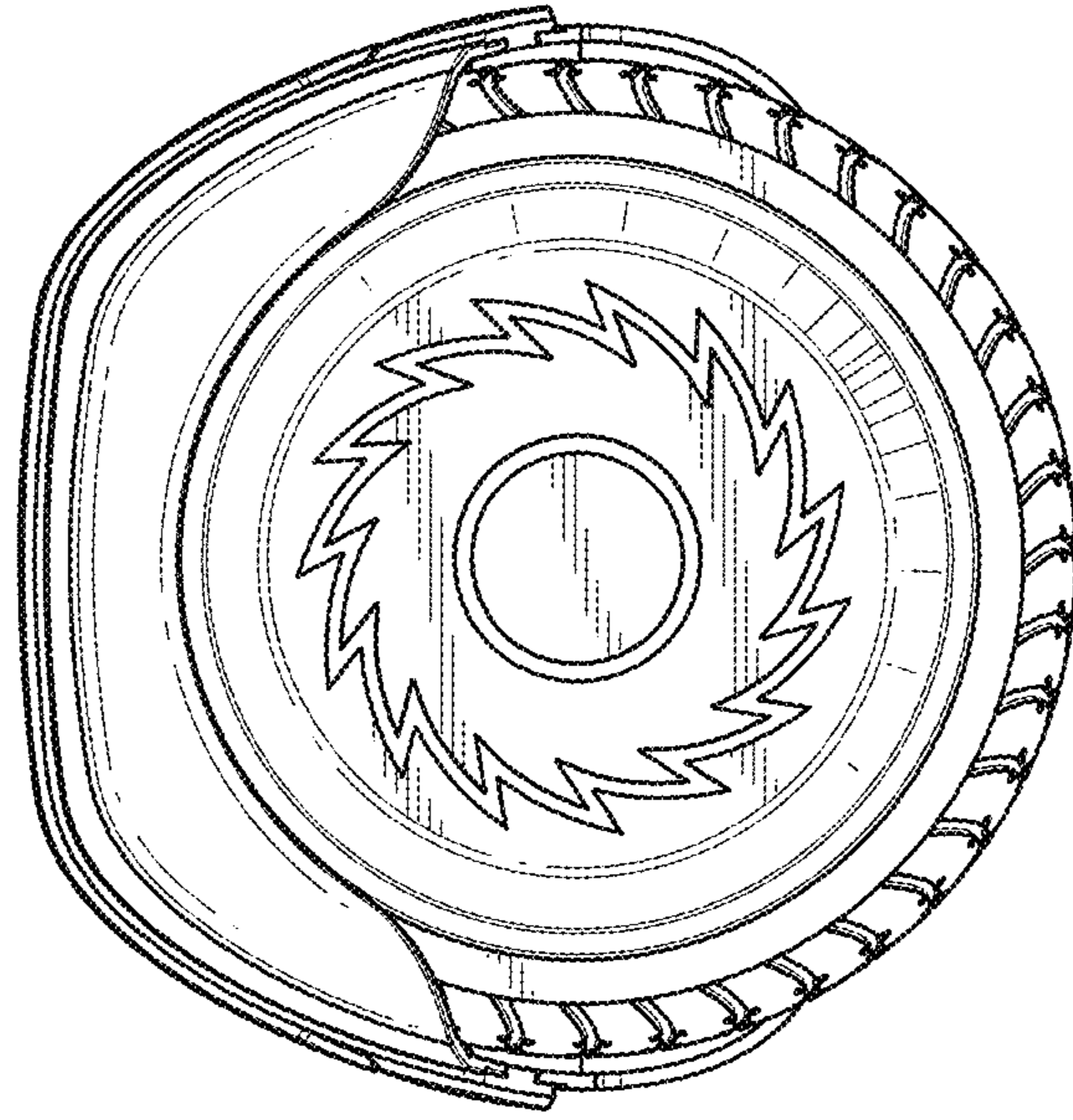

FIG. 8

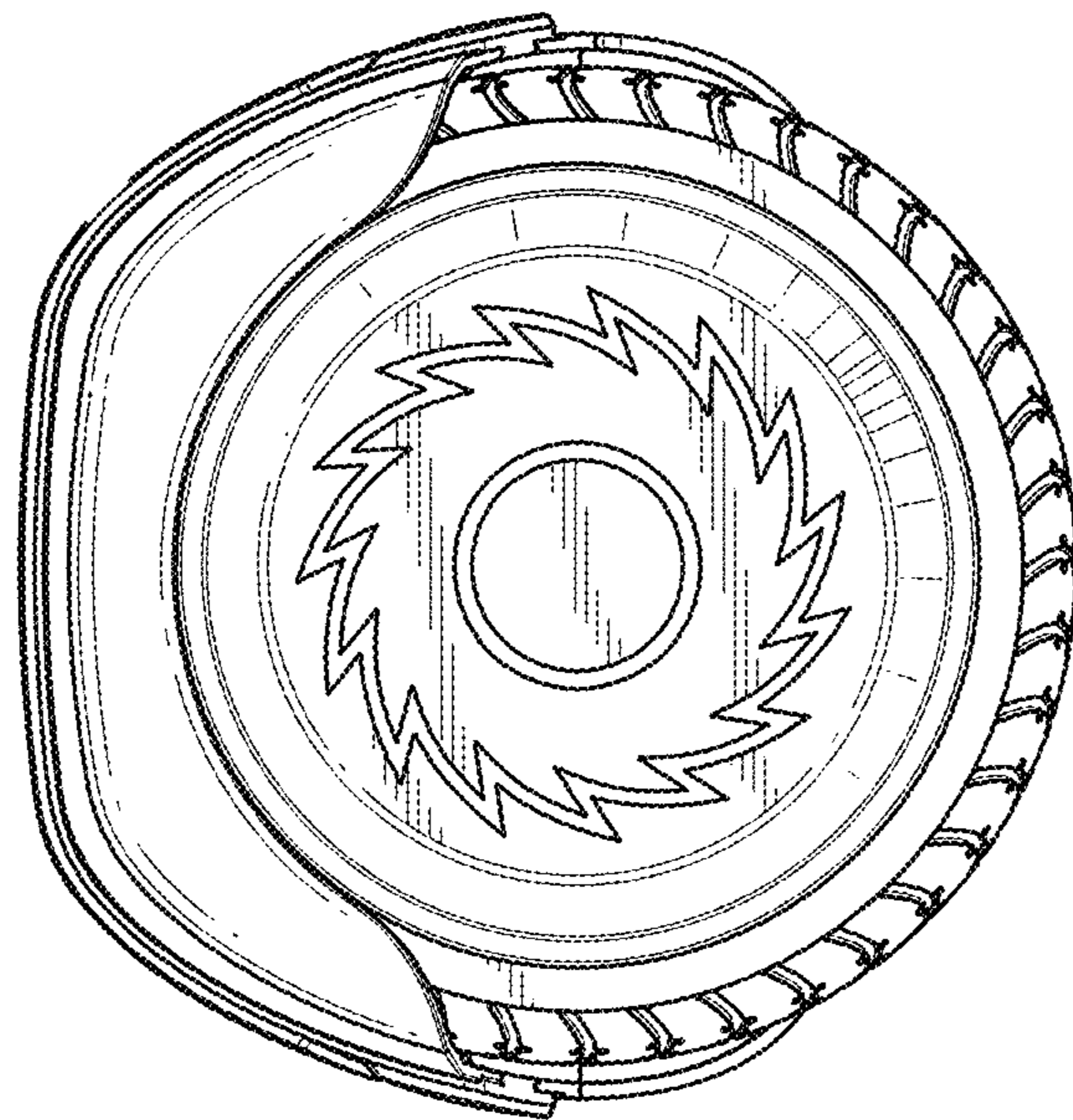

FIG. 7

UNITED STATES PATENT AND TRADEMARK OFFICE
CERTIFICATE OF CORRECTION

PATENT NO. : D837,322 S
APPLICATION NO. : 29/627176
DATED : January 1, 2019
INVENTOR(S) : Ian Desberg

Page 1 of 1

It is certified that error appears in the above-identified patent and that said Letters Patent is hereby corrected as shown below:

On Page 3, Column 1, Item (56), Line 30, under Other Publications, delete "1/2004 Heinzmann et al." and insert --3/2004 Kamen et al.--.

On Page 4, Column 2, Item (56), Line 45, under Other Publications, delete "10" and insert --IO--.

Signed and Sealed this
Third Day of March, 2020

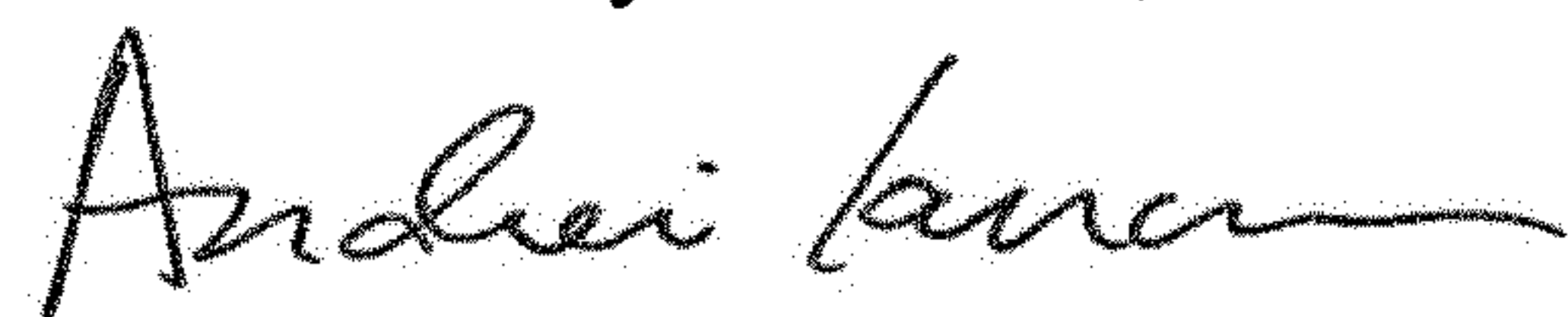

Andrei Iancu
Director of the United States Patent and Trademark Office