

US00D837287S

(12) **United States Design Patent**
Wong

(10) **Patent No.:** **US D837,287 S**

(45) **Date of Patent:** **** Jan. 1, 2019**

(54) **GUITAR**

(71) Applicant: **Tin-Ho Wong**, Hong Kong (HK)

(72) Inventor: **Tin-Ho Wong**, Hong Kong (HK)

(73) Assignee: **VOLA GUITAR LIMITED**, Hong Kong (HK)

(**) Term: **15 Years**

(21) Appl. No.: **29/610,058**

(22) Filed: **Jul. 9, 2017**

(51) **LOC (11) Cl.** **17-03**

(52) **U.S. Cl.**
USPC **D17/14**

(58) **Field of Classification Search**
USPC D17/14-21, 99; D21/405, 406, 407
CPC G10D 1/00; G10D 1/08; G10D 1/085;
G10D 3/00; G10D 3/06; G10D 3/02;
G10D 3/12; G10D 3/18; G10D 3/14
See application file for complete search history.

(56) **References Cited**

U.S. PATENT DOCUMENTS

D303,270 S	*	9/1989	Kaman, II	D17/14
D323,669 S	*	2/1992	Pagelli	D17/14
D372,491 S	*	8/1996	DeCola	D17/20
D409,647 S	*	5/1999	Dipinto	D17/14

D414,506 S	*	9/1999	Pyle	D17/14
D428,043 S	*	7/2000	Pyle	D17/14
D481,412 S	*	10/2003	Minarik	D17/20
D533,212 S	*	12/2006	Johnson	D17/20
D549,767 S	*	8/2007	Mitic	D17/14
D625,753 S	*	10/2010	Hoffman	D17/14
D637,190 S	*	5/2011	McGuire, II	D14/400
D662,539 S	*	6/2012	Mohajerin	D17/14
D667,485 S	*	9/2012	Nixon	D17/14
D681,104 S	*	4/2013	Yi	D17/20

FOREIGN PATENT DOCUMENTS

CN 201630233691 * 6/2016

* cited by examiner

Primary Examiner — Sheryl Lane
Assistant Examiner — Samantha N Wood

(57) **CLAIM**

The ornamental design for a guitar, as shown and described.

DESCRIPTION

FIG. 1 is perspective view of a guitar showing my new design;
FIG. 2 is a front elevational view thereof;
FIG. 3 is a top plan view thereof;
FIG. 4 is a left side elevational view thereof;
FIG. 5 is a rear elevational view thereof;
FIG. 6 is a right side elevational view thereof; and,
FIG. 7 is a bottom plan view thereof.

1 Claim, 7 Drawing Sheets

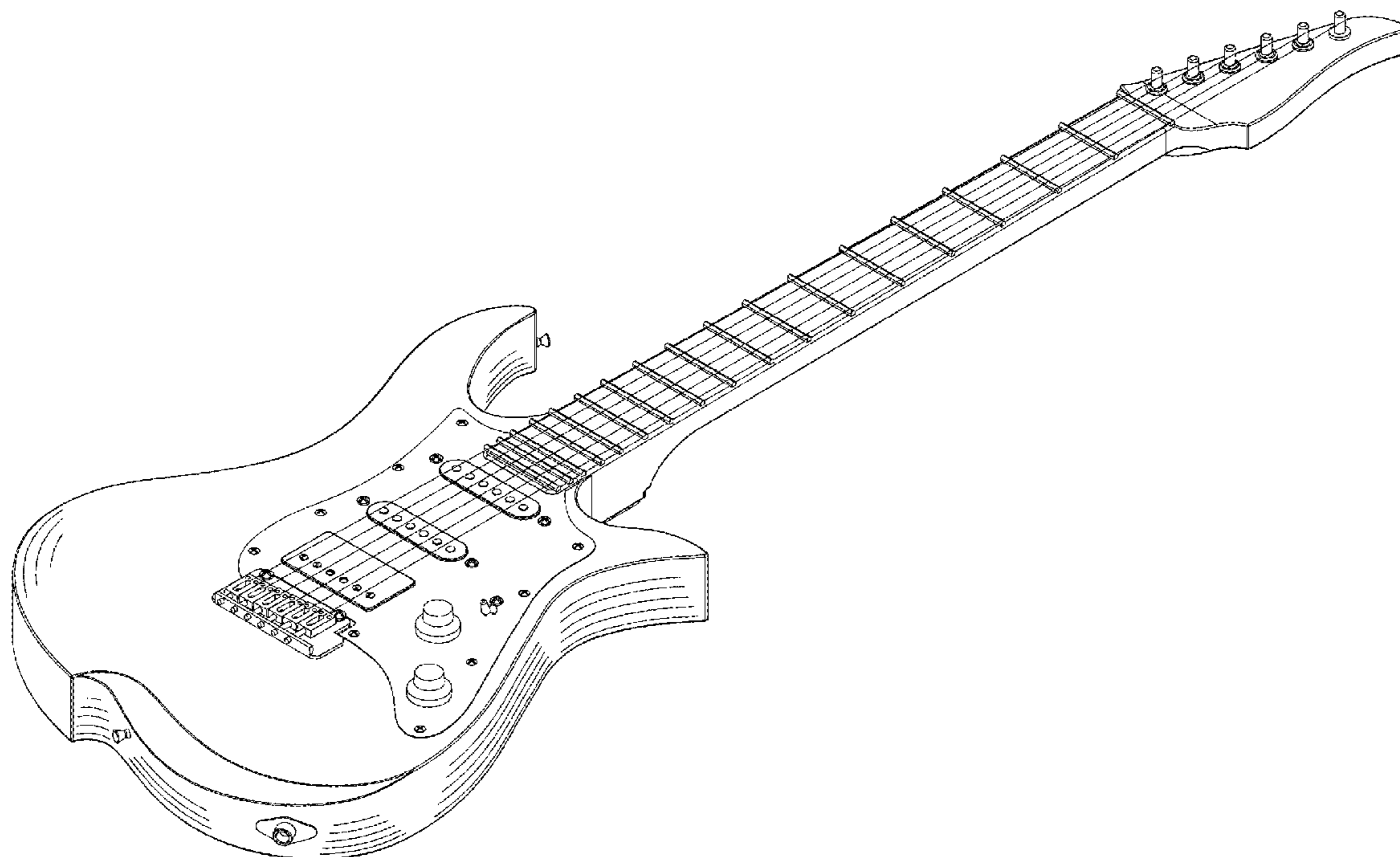

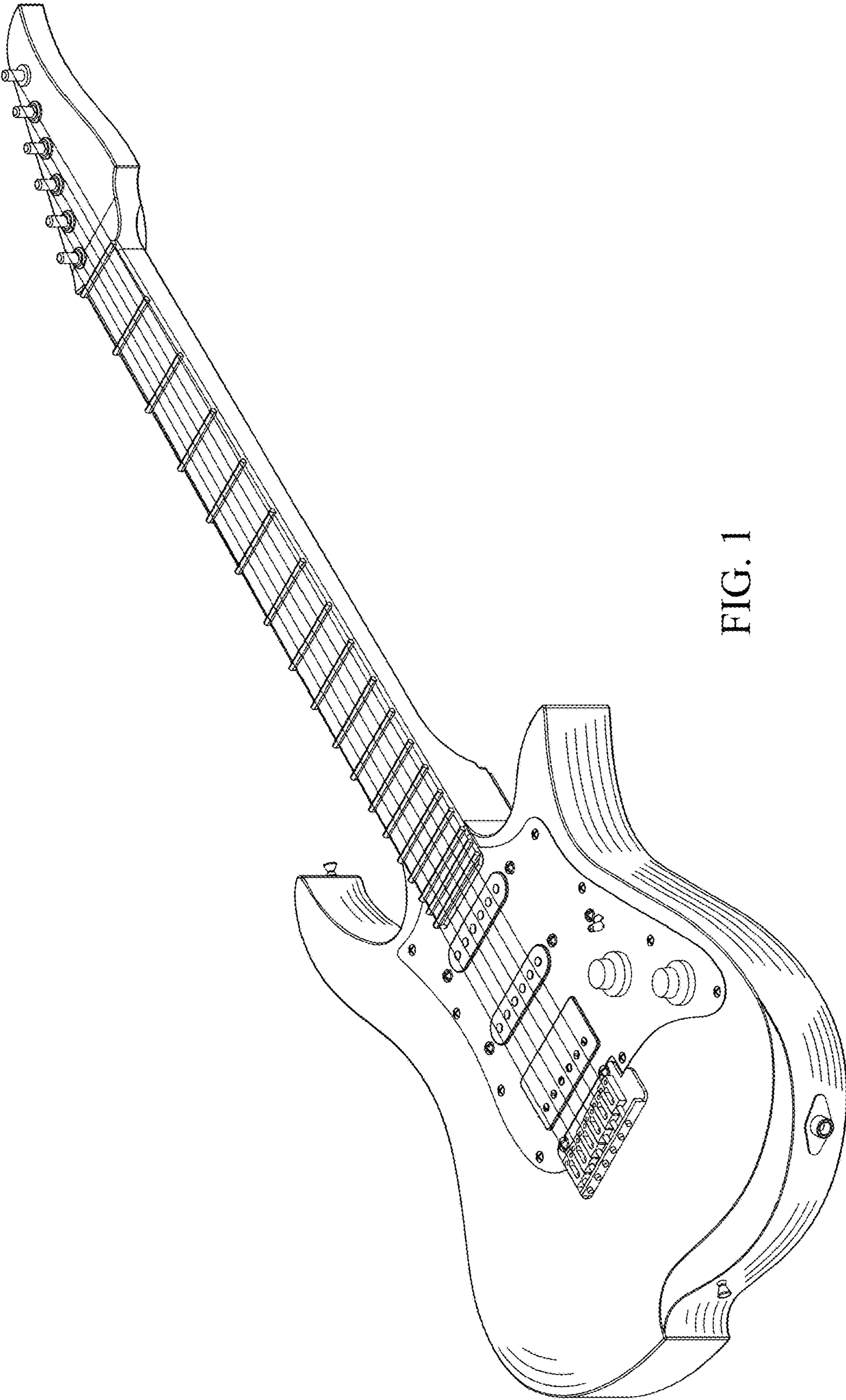

FIG. 1

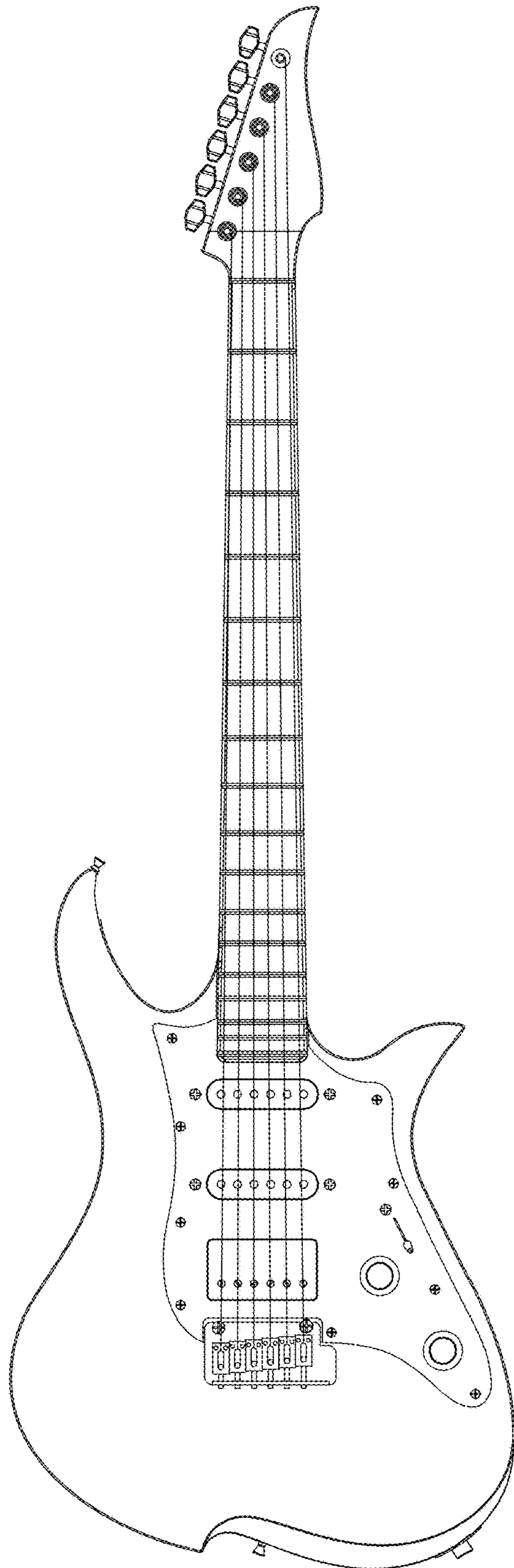

FIG. 2

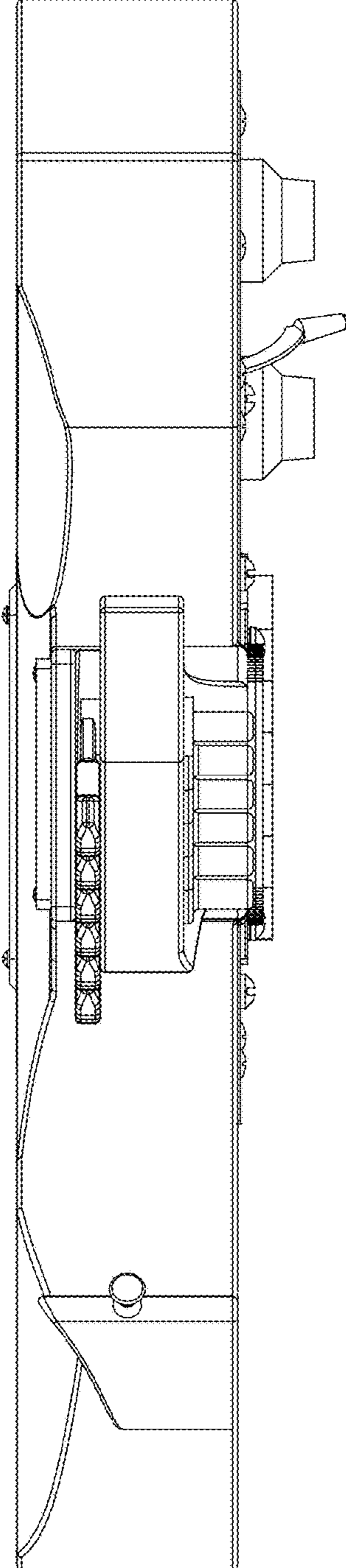

FIG. 3

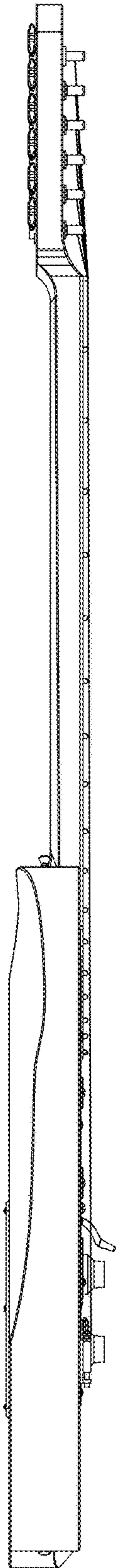

FIG. 4

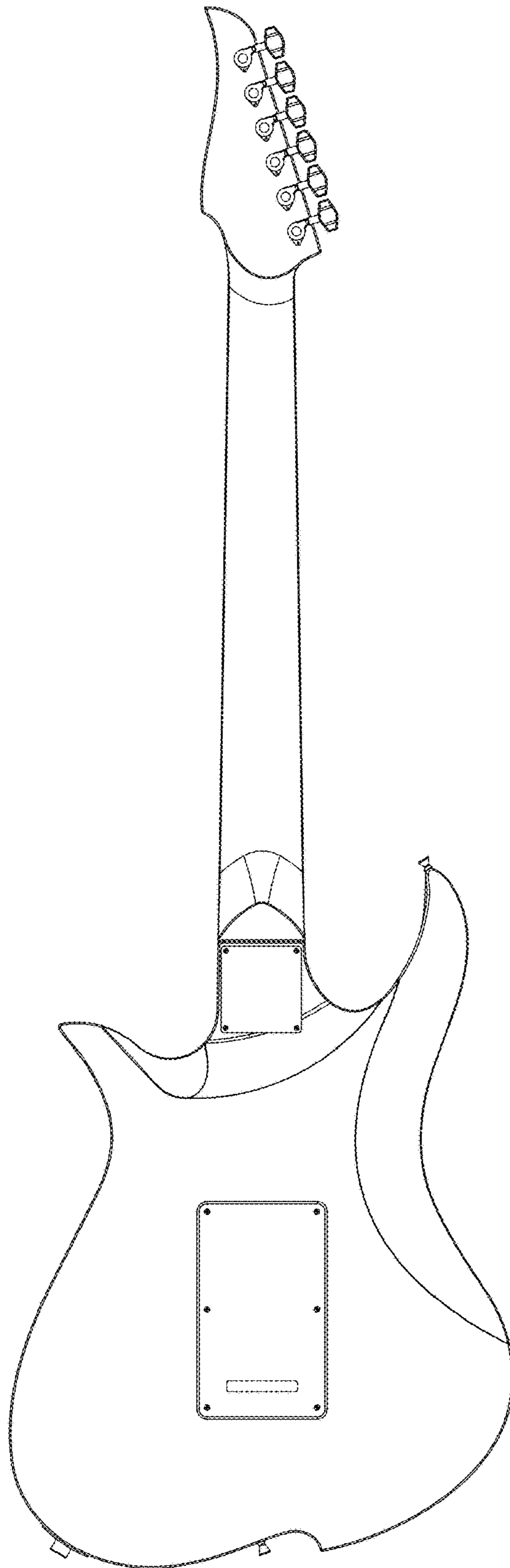

FIG. 5

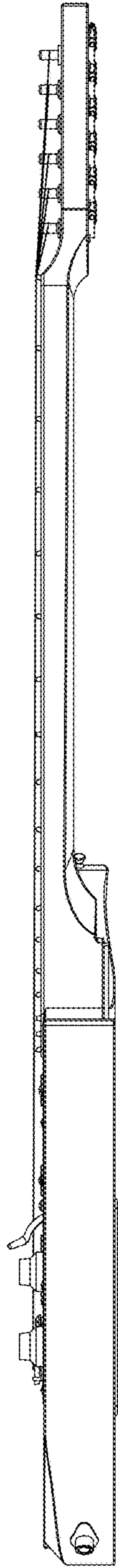

FIG. 6

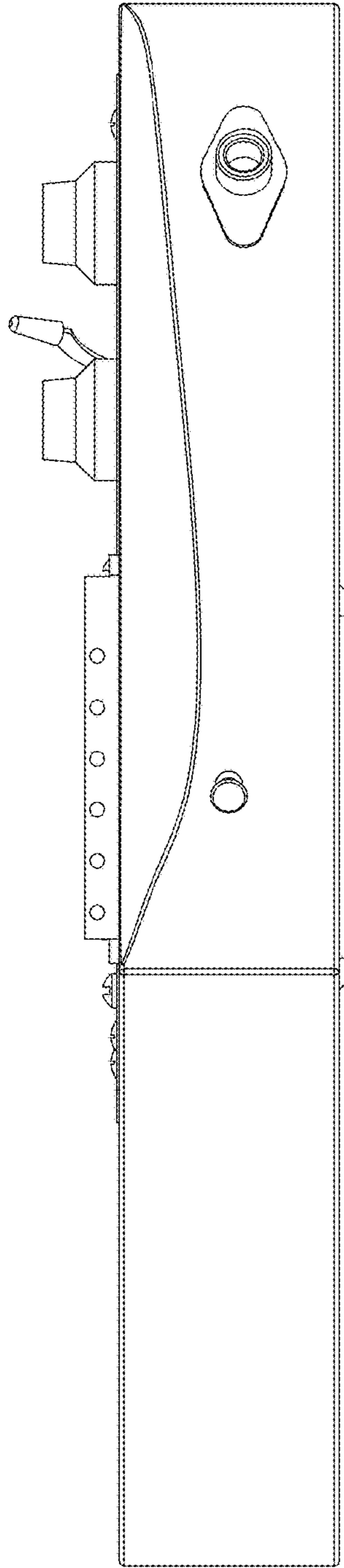

FIG. 7