



US00D837202S

(12) **United States Design Patent** (10) **Patent No.:** **US D837,202 S**
Lee et al. (45) **Date of Patent:** **** *Jan. 1, 2019**

(54) **NOTEBOOK LAPTOP COMPUTER**

G06F 1/1618; G06F 1/162; G06F 1/1679;
G06F 1/1681; G06F 1/1683

(71) Applicant: **LG ELECTRONICS INC.**, Seoul (KR)

See application file for complete search history.

(72) Inventors: **Heechang Lee**, Seoul (KR); **Taejin Lee**, Seoul (KR); **Gangho Woo**, Seoul (KR); **Sooyoung Park**, Seoul (KR)

(56) **References Cited**

U.S. PATENT DOCUMENTS

(73) Assignee: **LG ELECTRONICS INC.**, Seoul (KR)

D697,908	S	*	1/2014	Kim	D14/315
D705,216	S	*	5/2014	Baek	D14/315
D706,260	S	*	6/2014	Chae	D14/315
D736,200	S	*	8/2015	Kim	D14/315
D737,265	S	*	8/2015	Myung	D14/315
D737,811	S	*	9/2015	Lee	D14/315
D740,296	S	*	10/2015	Itano	D14/318

(*) Notice: This patent is subject to a terminal disclaimer.

(Continued)

(**) Term: **15 Years**

Primary Examiner — Michael A. Pratt

(21) Appl. No.: **35/503,732**

(74) Attorney, Agent, or Firm — Birch, Stewart, Kolasch & Birch, LLP

(22) Filed: **Mar. 27, 2017**

(80) **Hague Agreement Data**

Int. Filing Date: **Mar. 27, 2017**

Int. Reg. No.: **DM/096889**

Int. Reg. Date: **Mar. 27, 2017**

Int. Reg. Pub. Date: **Sep. 29, 2017**

(57) **CLAIM**

The ornamental design for a notebook laptop computer, as shown and described.

(30) **Foreign Application Priority Data**

Sep. 29, 2016 (KR) 30-2016-0047015

(51) **LOC (11) Cl.** **14-02**

(52) **U.S. Cl.**
USPC **D14/315**

(58) **Field of Classification Search**
USPC D14/315-327
CPC E05D 11/0081; E05D 3/10; E05D 11/082;
E05D 5/00; E05Y 2900/606; H05K
5/0226; Y10T 16/52; Y10T 16/533; Y10T
16/547; Y10T 16/5385; Y10T 16/5472;
Y10T 16/5476; Y10T 16/54038; F16M
11/10; G09G 5/00; H03K 17/94; G06F
1/16; G06F 1/1616; G06F 1/1626; G06F
1/1632; G06F 1/1613; G06F 1/1601;

DESCRIPTION

1. Notebook laptop computer
- 1.1 : Perspective
- 1.2 : Front
- 1.3 : Back
- 1.4 : Left
- 1.5 : Right
- 1.6 : Top
- 1.7 : Bottom
- 1.8 : Perspective
- 1.9 : Front
- 1.10 : Back
- 1.11 : Left
- 1.12 : Right
- 1.13 : Top
- 1.14 : Bottom

(Continued)

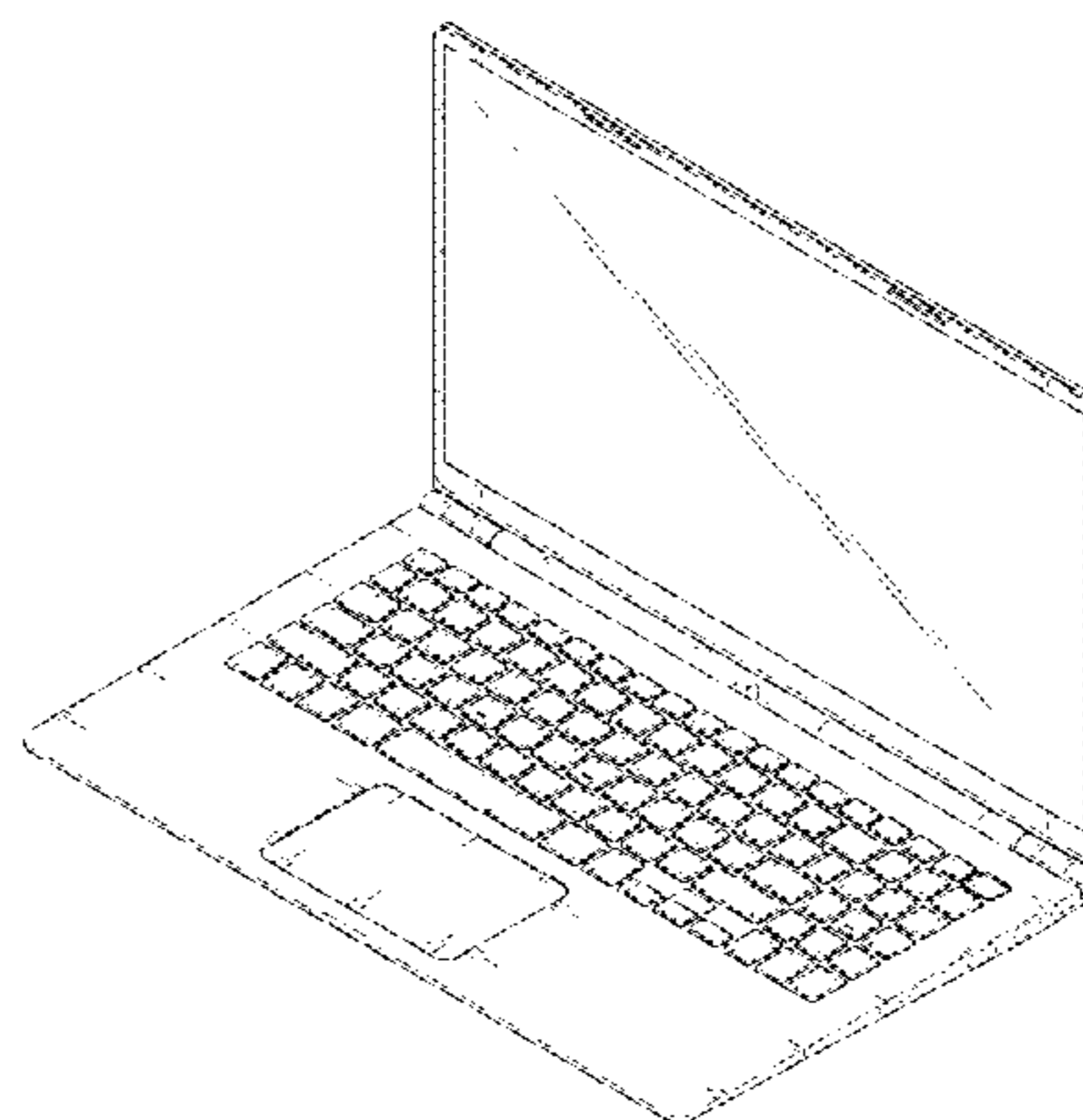
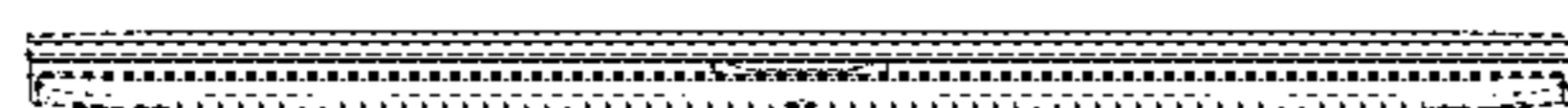

The present ornamental design is a combination of the shape and pattern of a notebook laptop computer as shown and described.

1 Claim, 14 Drawing Sheets

(56) **References Cited**

U.S. PATENT DOCUMENTS

D746,809	S	*	1/2016	Takada	D14/327
D747,710	S	*	1/2016	Lee	D14/315
D753,645	S	*	4/2016	Tian	D14/315
D759,649	S	*	6/2016	Schoenith	D14/315
D763,249	S	*	8/2016	Lee	D14/315
D765,653	S	*	9/2016	Lin	D14/318
D766,232	S	*	9/2016	Suzuki	D14/315
D774,505	S	*	12/2016	Akana	D14/318
D786,858	S	*	5/2017	Cheng	D14/315
D795,245	S	*	8/2017	Seoc	D14/315
D797,719	S	*	9/2017	Chu	D14/315
D804,466	S	*	12/2017	Okuley	D14/315
D804,467	S	*	12/2017	Probst	D14/315
D804,468	S	*	12/2017	Armstrong	D14/315
D805,066	S	*	12/2017	Leabman	D14/315
D806,701	S	*	1/2018	Akana	D14/315
D807,342	S	*	1/2018	Chang	D14/315
D810,069	S	*	2/2018	Hishiki	D14/316
D810,071	S	*	2/2018	Hishiki	D14/318
D819,017	S	*	5/2018	Akana	D14/318
D820,829	S	*	6/2018	Wang	D14/318

* cited by examiner

1.1

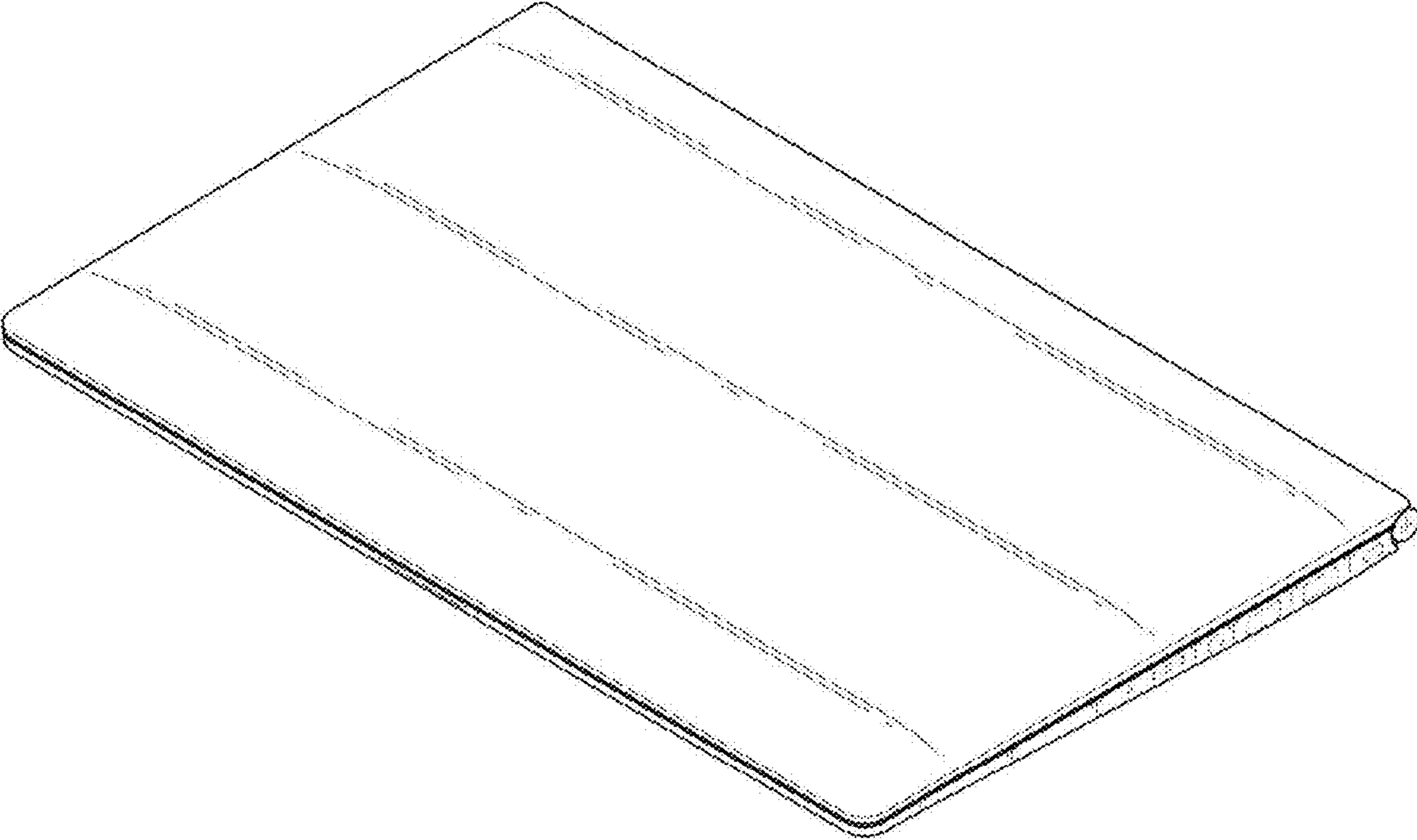

1.2



1.3

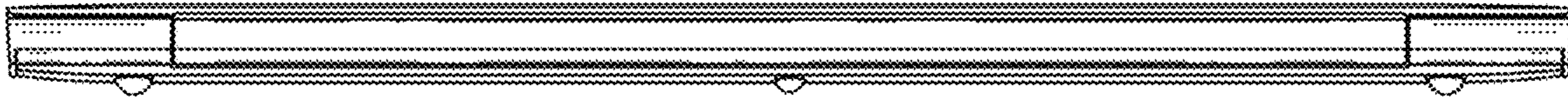

1.4

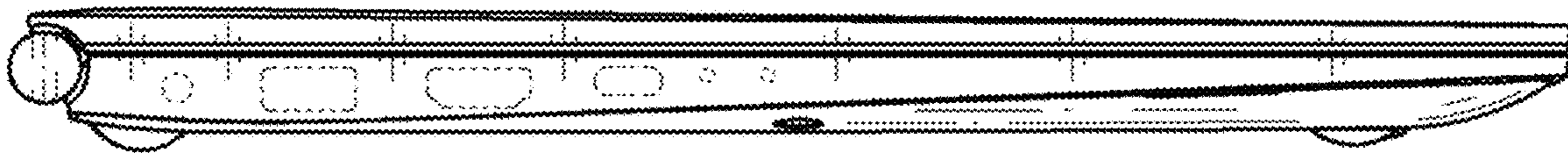

1.5

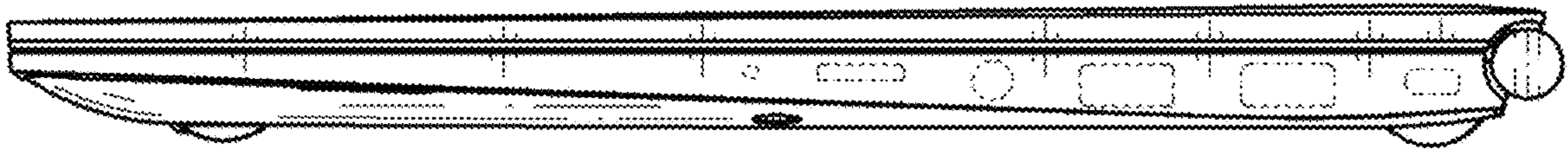

1.6

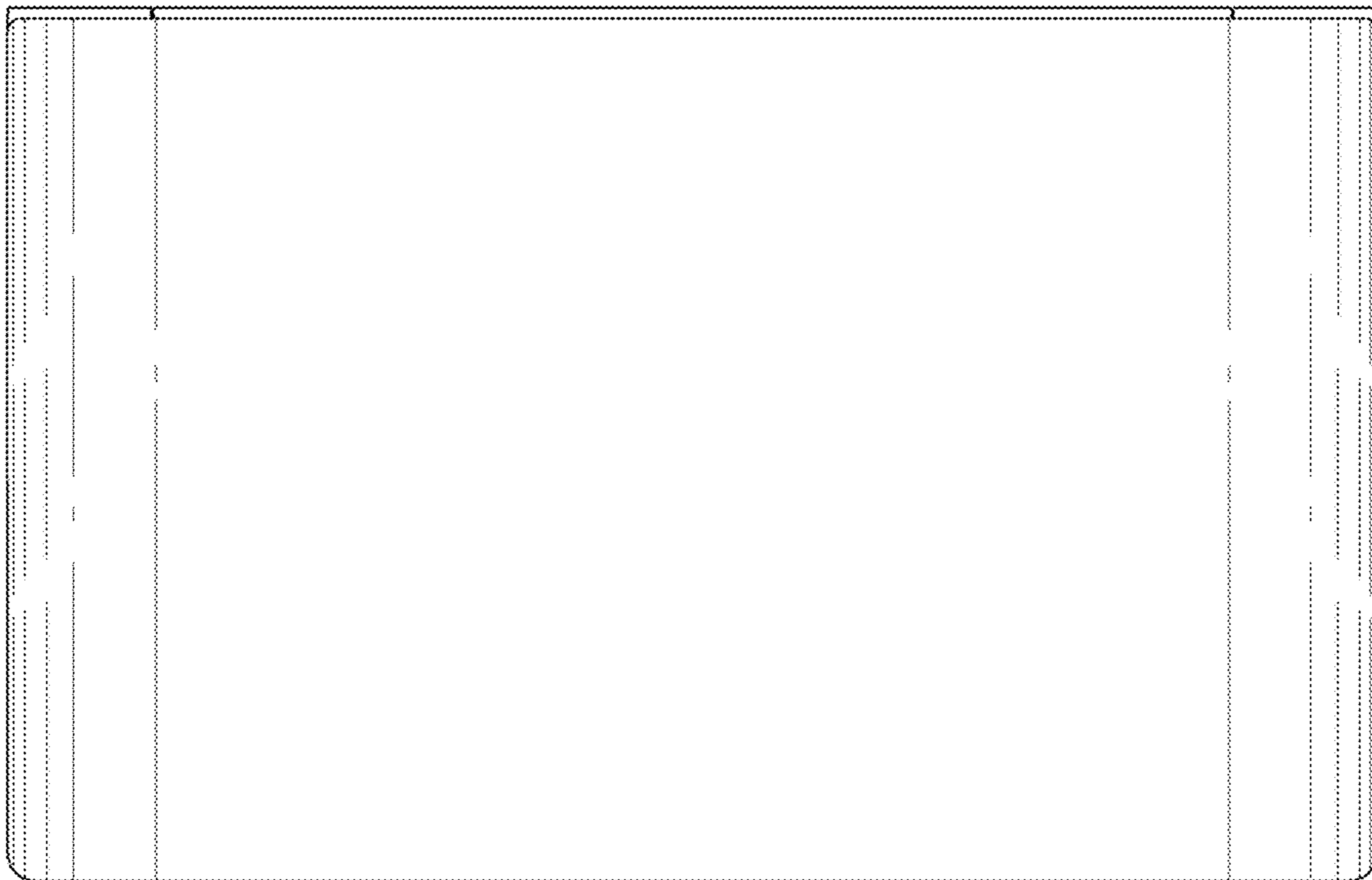

1.7

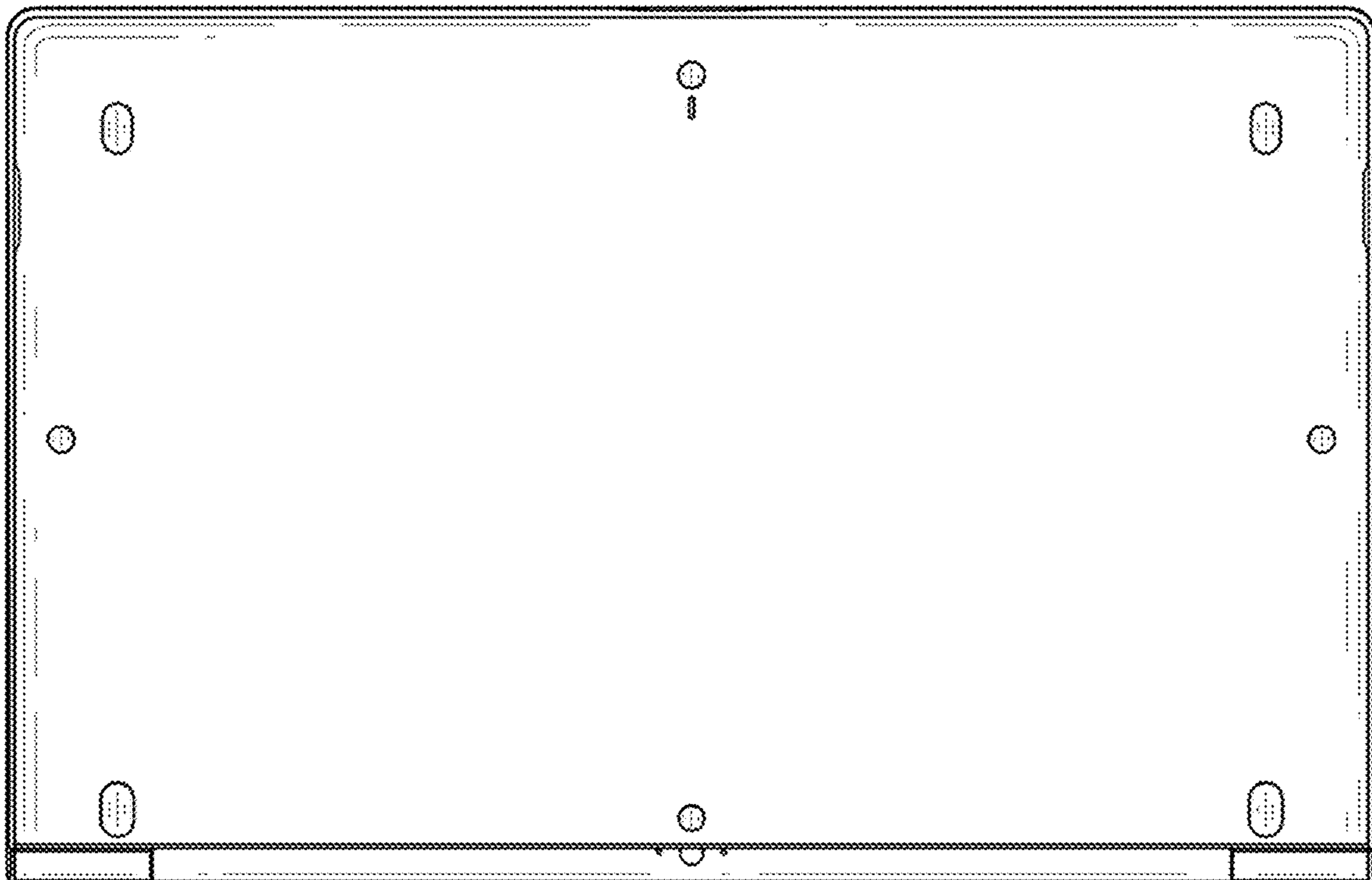

1.8

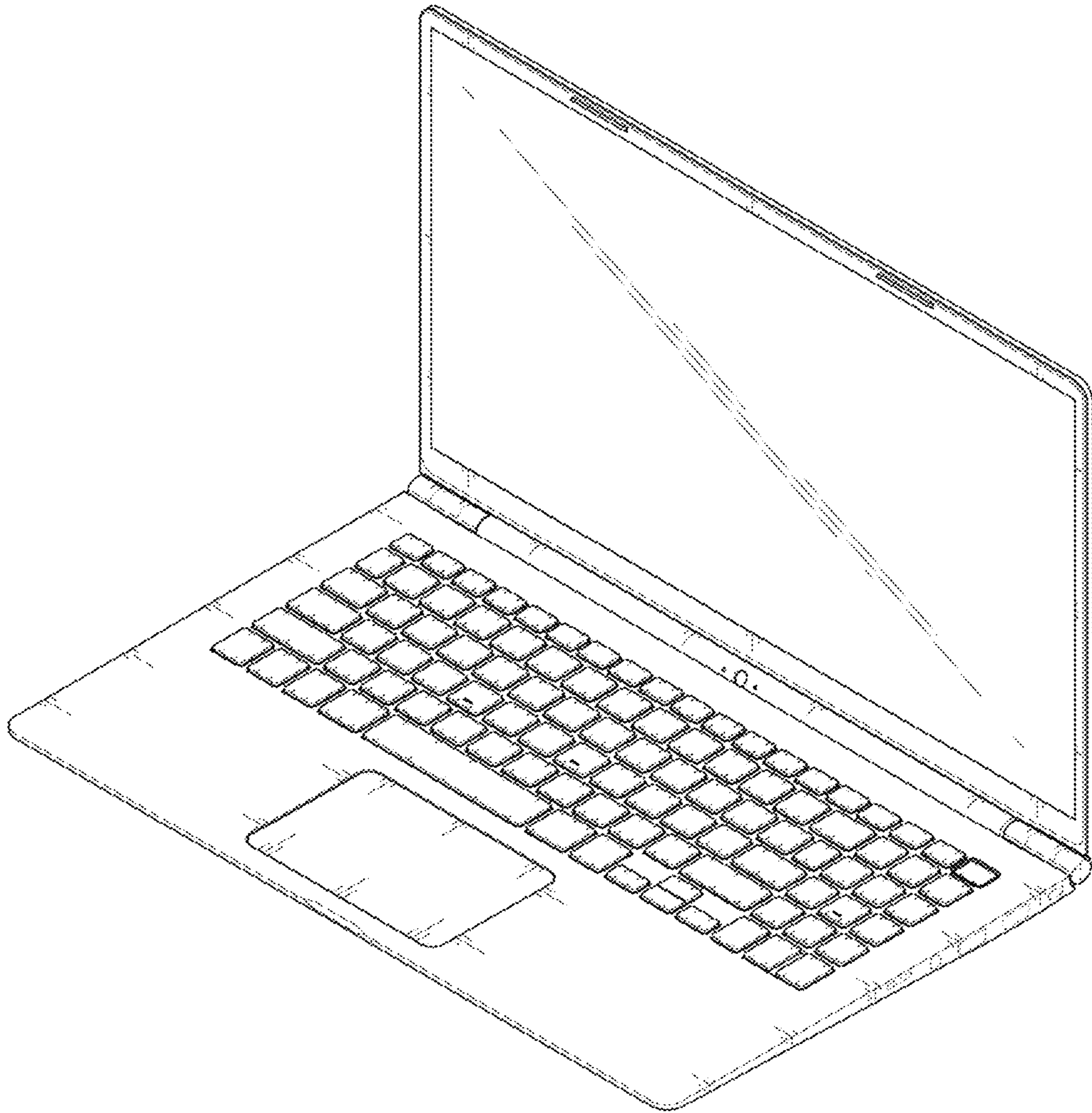

1.9

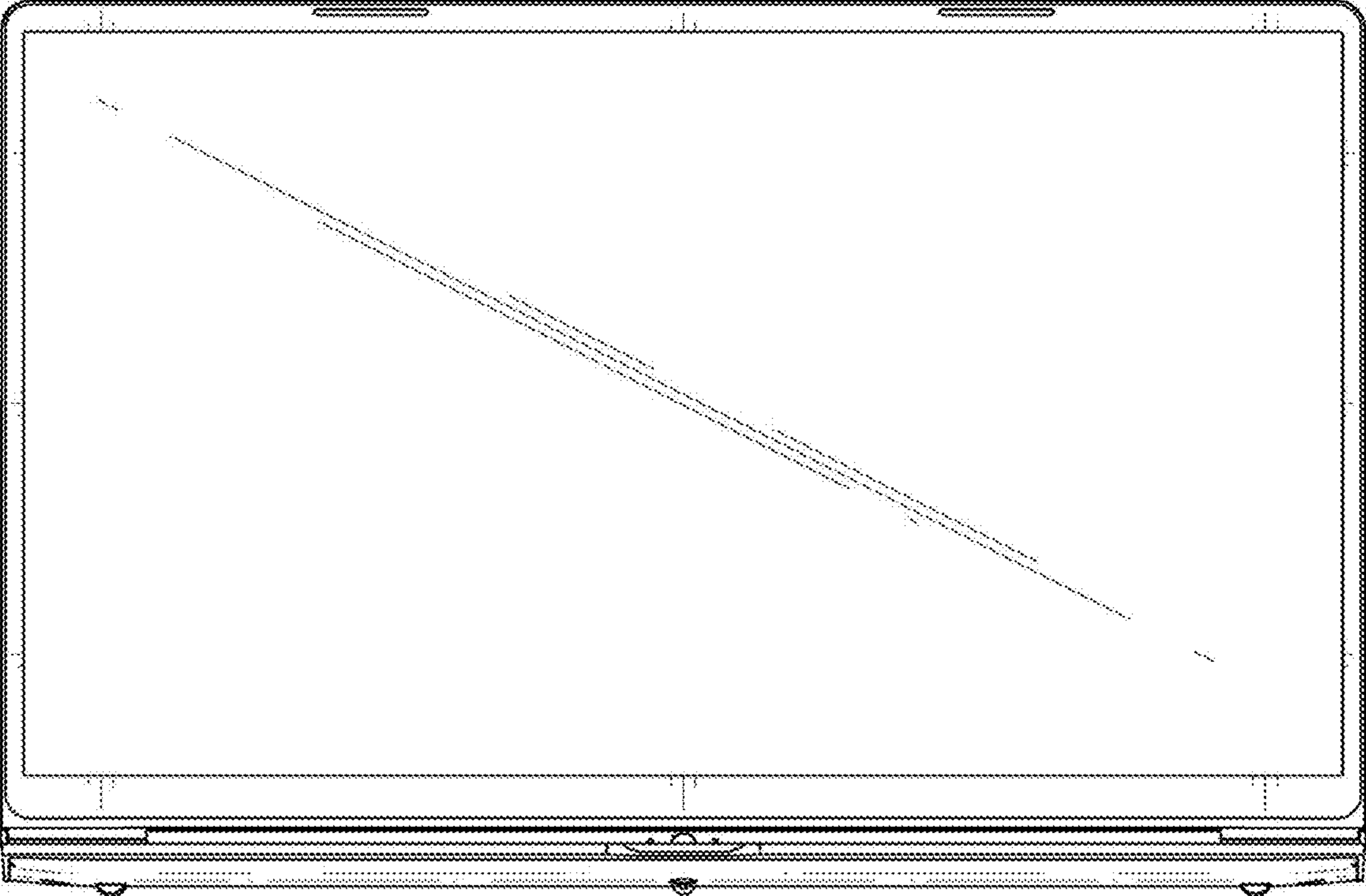

1.10

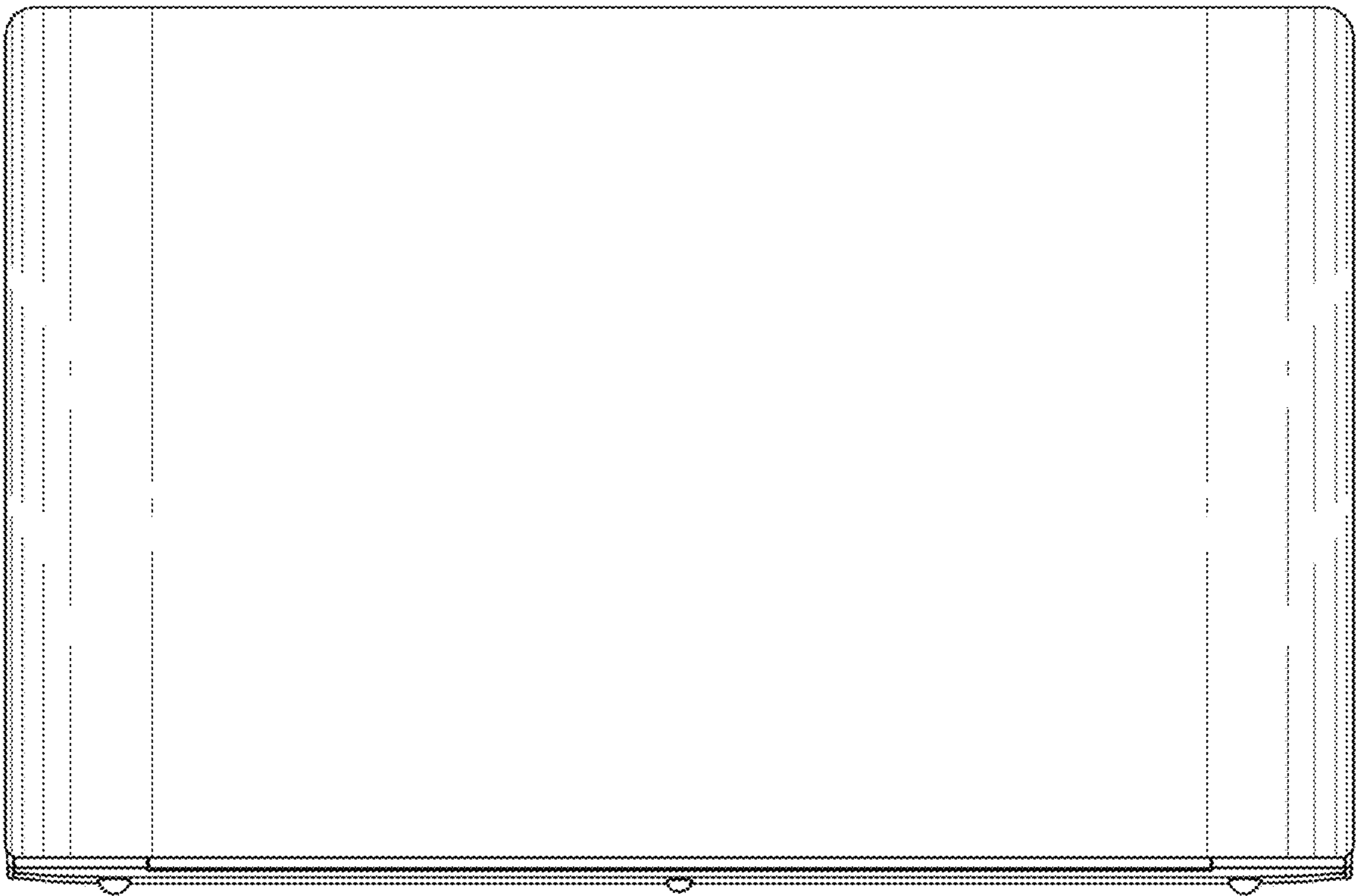

1.11

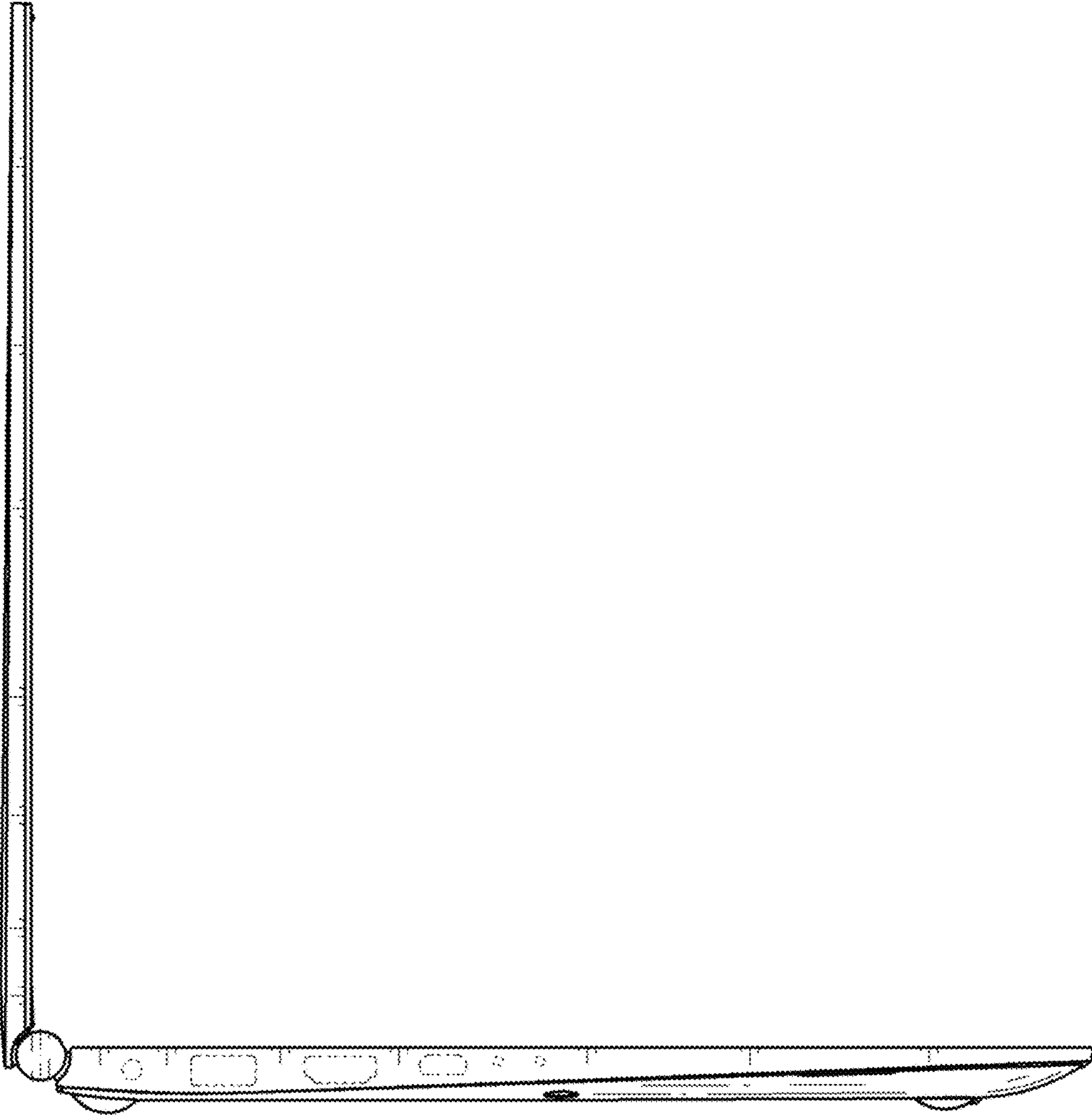

1.12

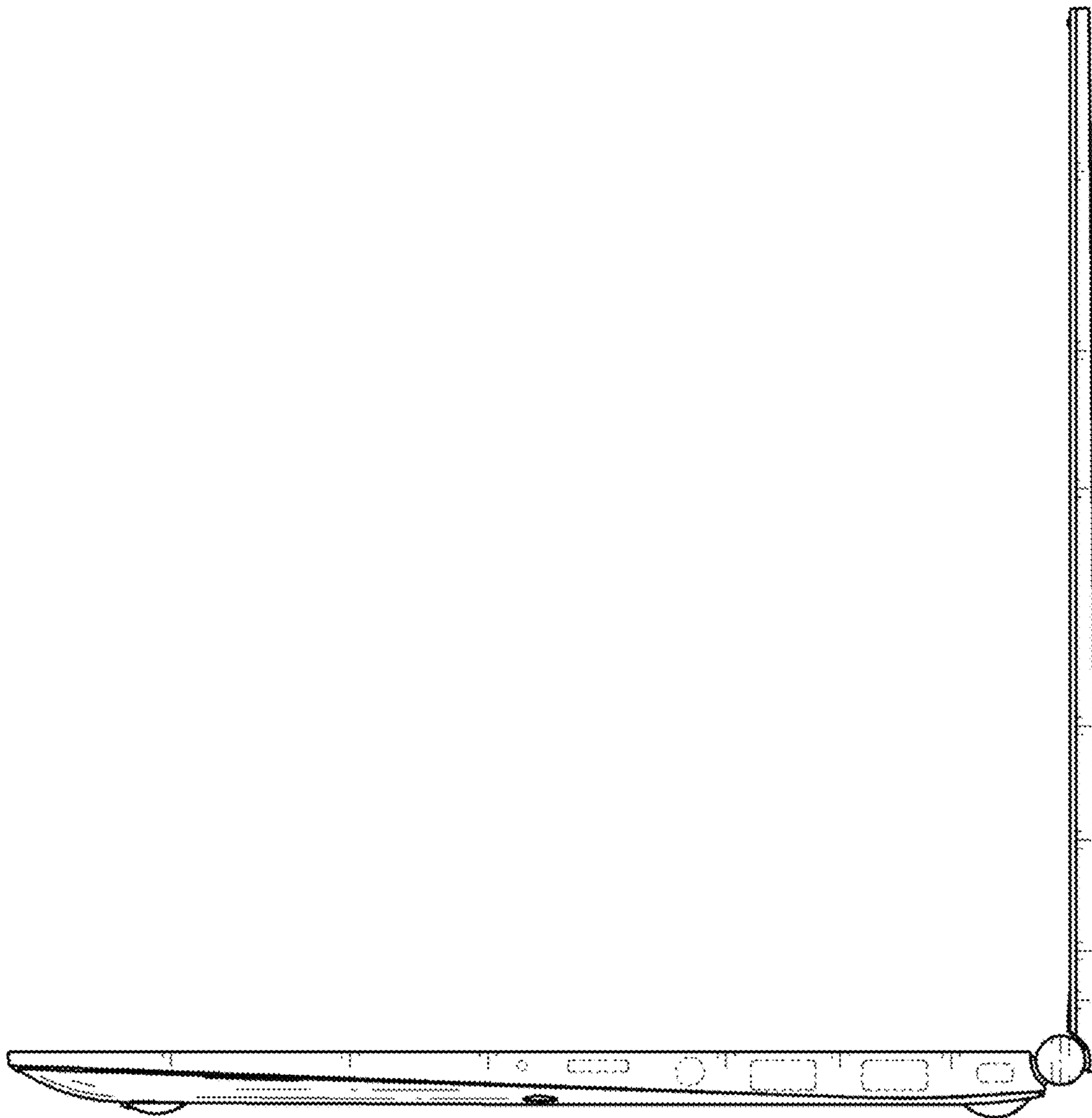

1.13

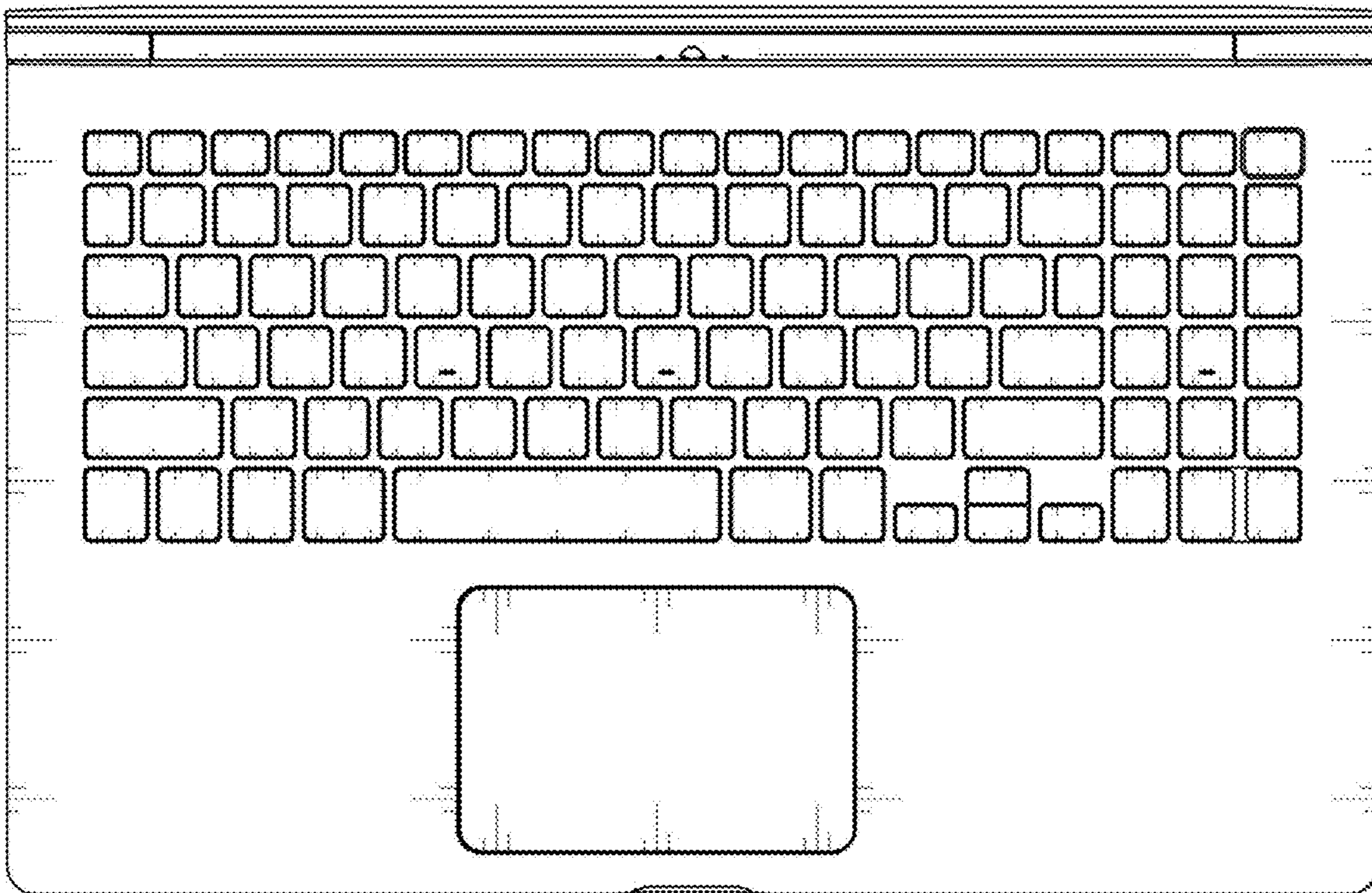

1.14

