



US00D837096S

(12) **United States Design Patent** (10) **Patent No.:** **US D837,096 S**  
**Venables** (45) **Date of Patent:** **\*\* Jan. 1, 2019**

(54) **SNAP FASTENER ASSEMBLY**  
(71) Applicant: **World Tour Enterprises, Ltd.**,  
Farmingdale, NJ (US)  
(72) Inventor: **Brian Venables**, Farmingdale, NJ (US)  
(73) Assignee: **WORLD TOUR ENTERPRISES,**  
**LTD.**, Farmingdale, NJ (US)  
(\*\*) Term: **15 Years**

D386,971 S 12/1997 Lecoule  
D403,952 S \* 1/1999 Podell ..... D11/220  
D404,997 S 2/1999 Podell  
D408,741 S 4/1999 Mohary  
D413,282 S 8/1999 Aoki  
D426,491 S \* 6/2000 Chan ..... D11/220  
D430,483 S \* 9/2000 Wah ..... D11/220  
D432,400 S \* 10/2000 Chan ..... D11/220

(Continued)

*Primary Examiner* — Zenia I Bennett

(74) *Attorney, Agent, or Firm* — Hodgson Russ LLP

(21) Appl. No.: **29/661,549**  
(22) Filed: **Aug. 28, 2018**  
(51) **LOC (11) Cl.** ..... **11-07**  
(52) **U.S. Cl.**  
USPC ..... **D11/220**  
(58) **Field of Classification Search**  
USPC ..... D11/220, 222, 226, 218  
CPC . A44B 17/00; A44B 17/0023; A44B 17/0029;  
A44B 17/0035; A44B 17/0041; A44B  
17/0064; A44B 17/007; A44B 17/0076;  
A44B 17/0088; A44B 17/0094  
See application file for complete search history.

(57) **CLAIM**

The ornamental design for a snap fastener assembly, as shown and described.

**DESCRIPTION**

FIG. 1 is a perspective view of a female piece of a snap fastener assembly;  
FIG. 2 is a front elevation view thereof;  
FIG. 3 is a top plan view thereof;  
FIG. 4 is a bottom plan view thereof;  
FIG. 5 is a right side elevation view thereof, the left side elevation view being symmetrical thereto;  
FIG. 6 is a cross-sectional view thereof, taken along 6-6 of FIG. 2;  
FIG. 7 is a perspective view of a male piece of the snap fastener assembly;  
FIG. 8 is top plan view thereof, the bottom plan view being omitted as it does not include any claimed features;  
FIG. 9 is a rear elevation view thereof;  
FIG. 10 is a top plan view thereof, the bottom plan view being mirror symmetrical thereto; and,  
FIG. 11 is a cross-sectional view thereof, showing the male piece mated with the female piece.  
The short dash-short dash lines in the figures illustrate portions of the snap fastener assembly that form no part of the claimed design. The long dash-short dash lines indicate a surface boundary of the snap fastener assembly.

(56) **References Cited**

U.S. PATENT DOCUMENTS

D56,687 S 11/1920 Baum  
D67,959 S 8/1925 Javal  
D169,111 S 3/1953 Smith  
D184,611 S 3/1959 Du Pree  
D189,698 S 1/1961 Du Pree  
D261,232 S 10/1981 Grip  
D277,934 S 3/1985 Beckrot  
D301,566 S \* 6/1989 Heiberger ..... D11/218  
D301,567 S 6/1989 Burke  
D311,653 S 10/1990 Lindauer  
D329,605 S 9/1992 Crawford  
D341,323 S 11/1993 Cazaudehore  
D369,553 S 5/1996 Heinz  
D386,673 S 11/1997 Thompson

**1 Claim, 7 Drawing Sheets**

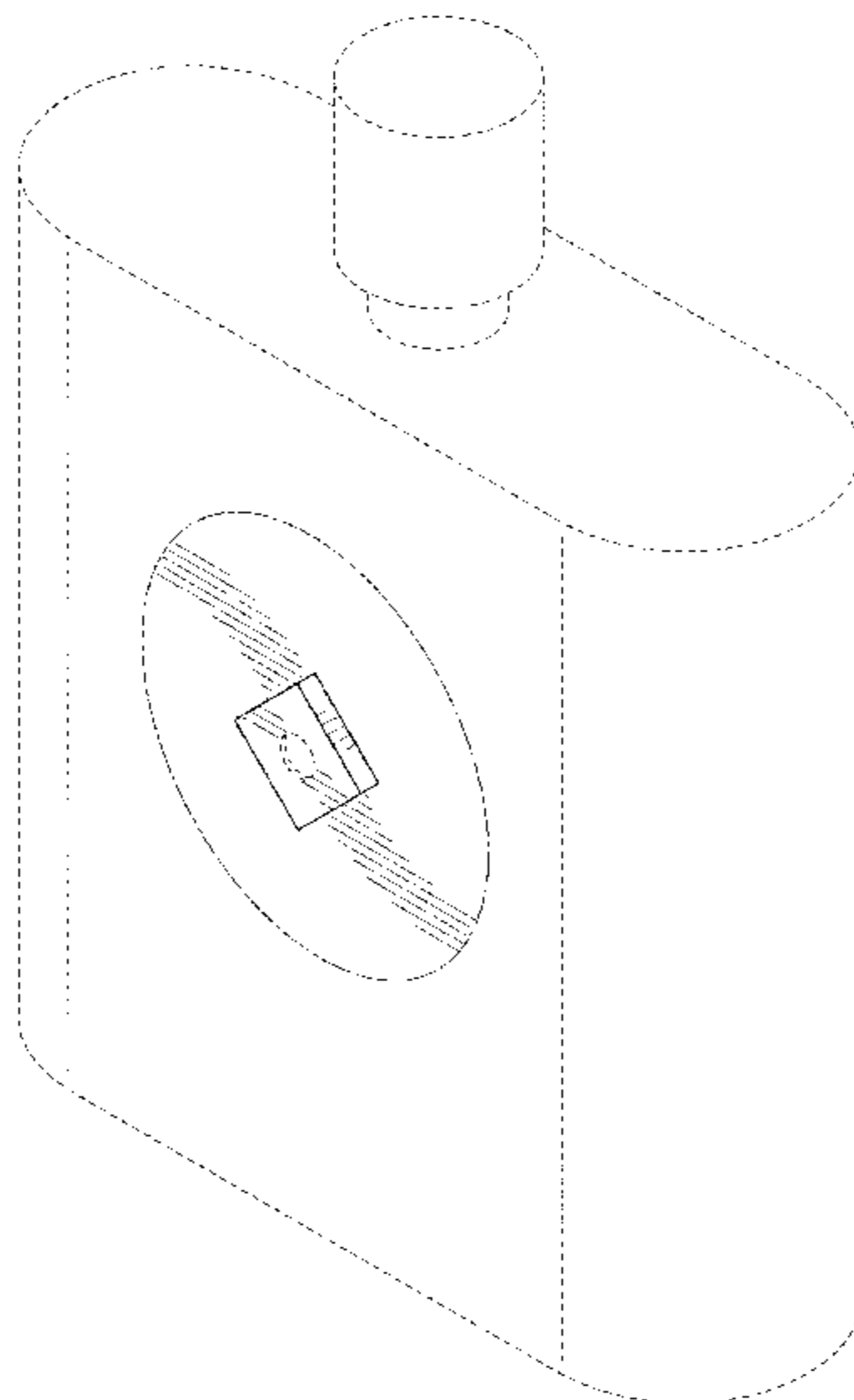

(56)

References Cited

U.S. PATENT DOCUMENTS

D438,451 S	*	3/2001	Reiter	.....	D11/220	D665,304 S	8/2012	Takeda			
D438,490 S		3/2001	Akashi			D674,288 S	1/2013	Gieske			
D450,625 S	*	11/2001	Khromachou	.....	D11/220	D676,331 S	2/2013	Hartford			
D452,644 S	*	1/2002	Morita	.....	D11/220	D680,877 S	4/2013	Ghandour			
D464,562 S		10/2002	Reiter			D684,865 S	6/2013	Petronio			
D466,439 S		12/2002	Wagner			D689,369 S	9/2013	Dumas			
D467,182 S		12/2002	Pelusi			D695,126 S	12/2013	Versace			
D475,632 S		6/2003	Cooper			D696,136 S	12/2013	Gieske			
D479,133 S		9/2003	Quintero			D701,768 S	4/2014	Baker			
D489,292 S		5/2004	Matsui			D707,584 S	*	6/2014	Webb	.....	D11/87
D498,665 S		11/2004	Mansau			D727,742 S		4/2015	Jacobs		
D504,317 S		4/2005	Mansau			D728,417 S	*	5/2015	Pferdehirt	.....	D11/220
D517,947 S		3/2006	Hollingworth			D728,418 S	*	5/2015	Pferdehirt	.....	D11/220
D539,698 S	*	4/2007	Choi	.....	D11/220	D742,787 S		11/2015	Schoenbeck		
D555,496 S		11/2007	Osgerby			D748,489 S		2/2016	Ricci		
D570,202 S		6/2008	Katoh			D759,497 S		6/2016	Versace		
D617,644 S		6/2010	Leventhal			D763,701 S		8/2016	Hayek		
D630,520 S		1/2011	Yu			D779,929 S		2/2017	Matus		
D631,364 S		1/2011	Da Vinci			D785,460 S		5/2017	Larminaux		
D640,137 S		6/2011	Martone			D786,686 S		5/2017	Robin-Prevallee		
D646,573 S		10/2011	Kubicek			D792,781 S		7/2017	Shaver		
D649,471 S		11/2011	Guglielmo			D798,186 S	*	9/2017	Palko-Corona	.....	D11/87
D652,310 S		1/2012	Hartford			D815,541 S		4/2018	Harris		
						D815,542 S		4/2018	Harris		
						D818,370 S		5/2018	Harris		
						D818,393 S		5/2018	Chen		

\* cited by examiner

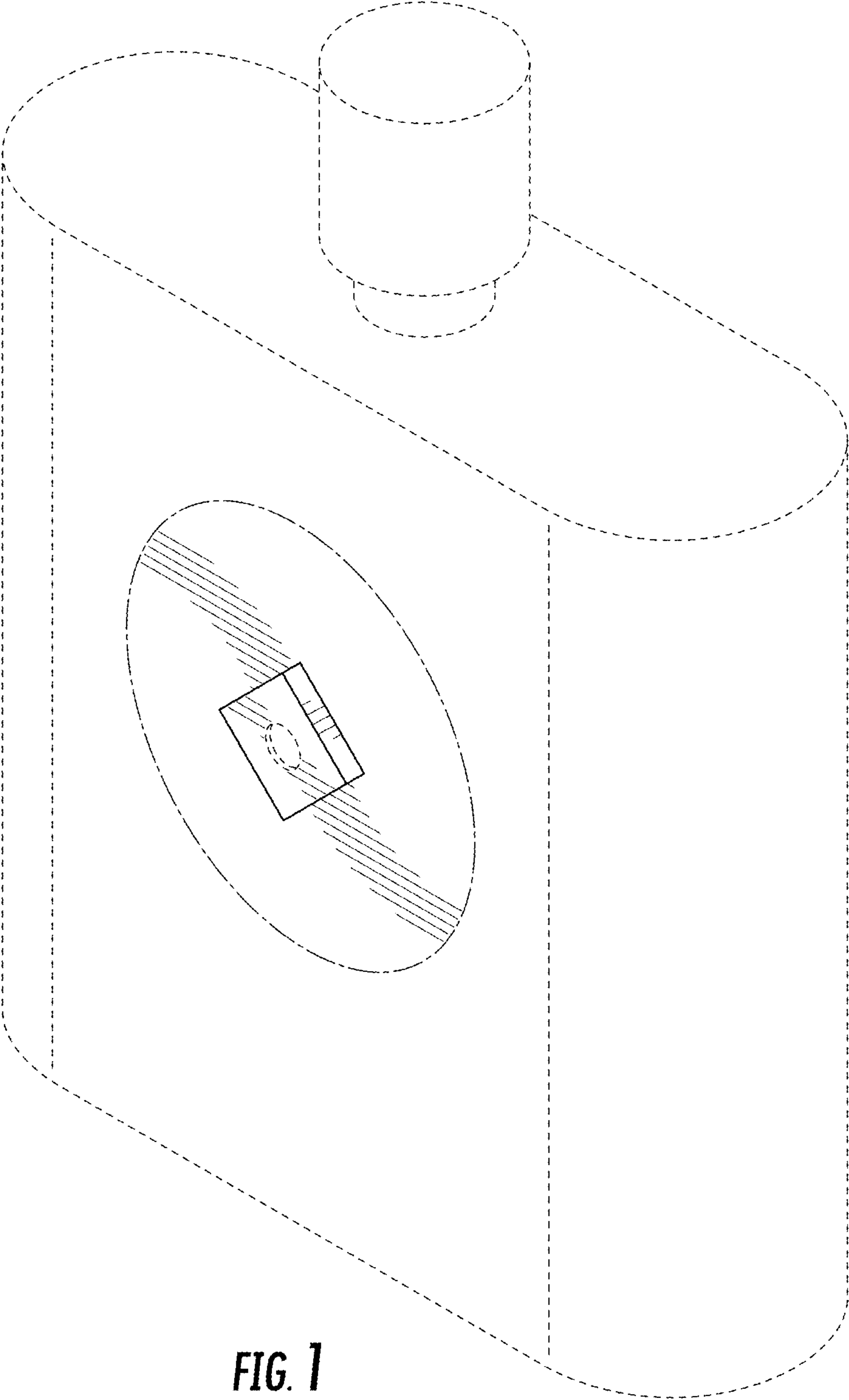

**FIG. 1**

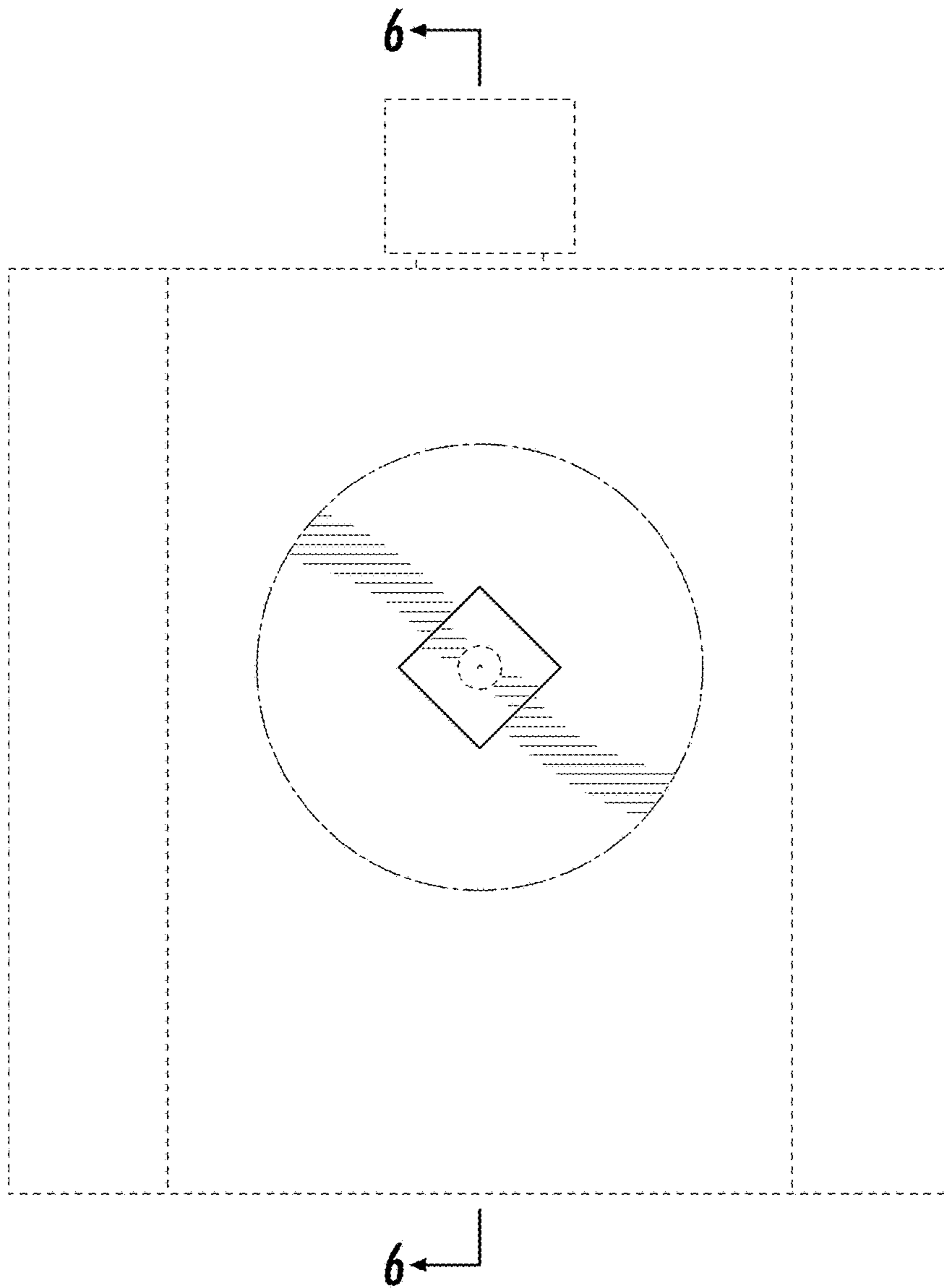
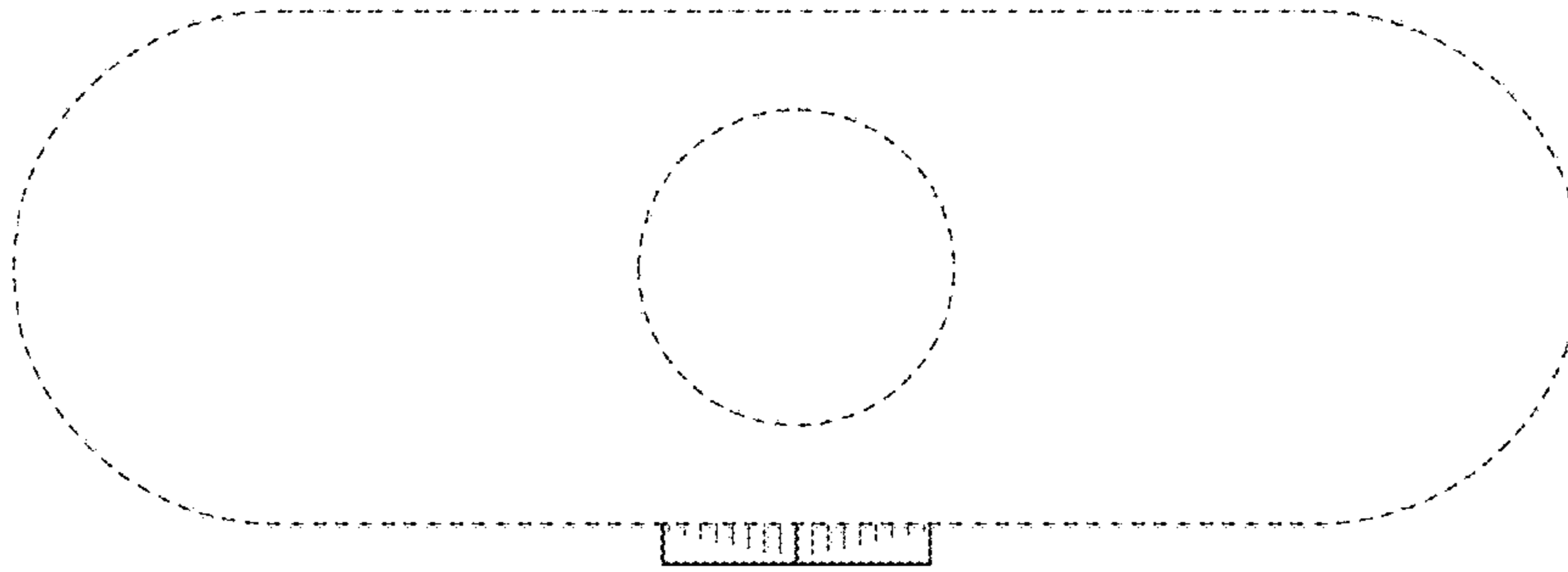
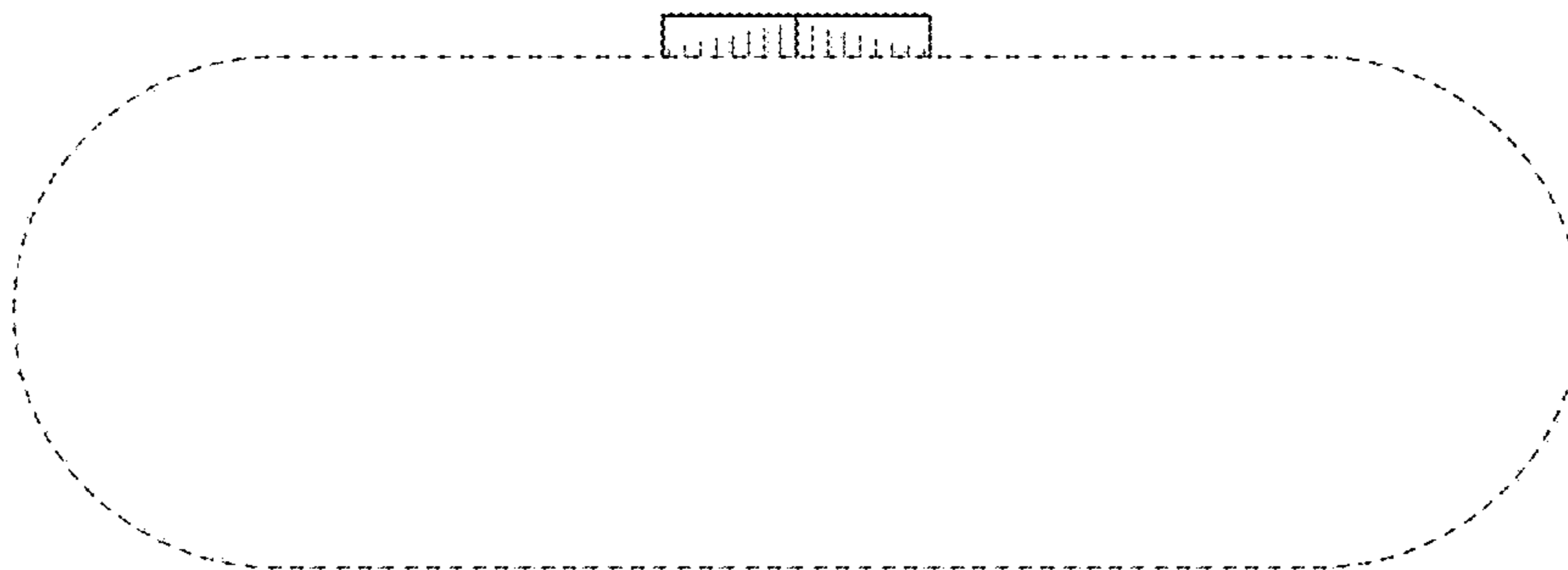

FIG. 2



**FIG. 3**



**FIG. 4**

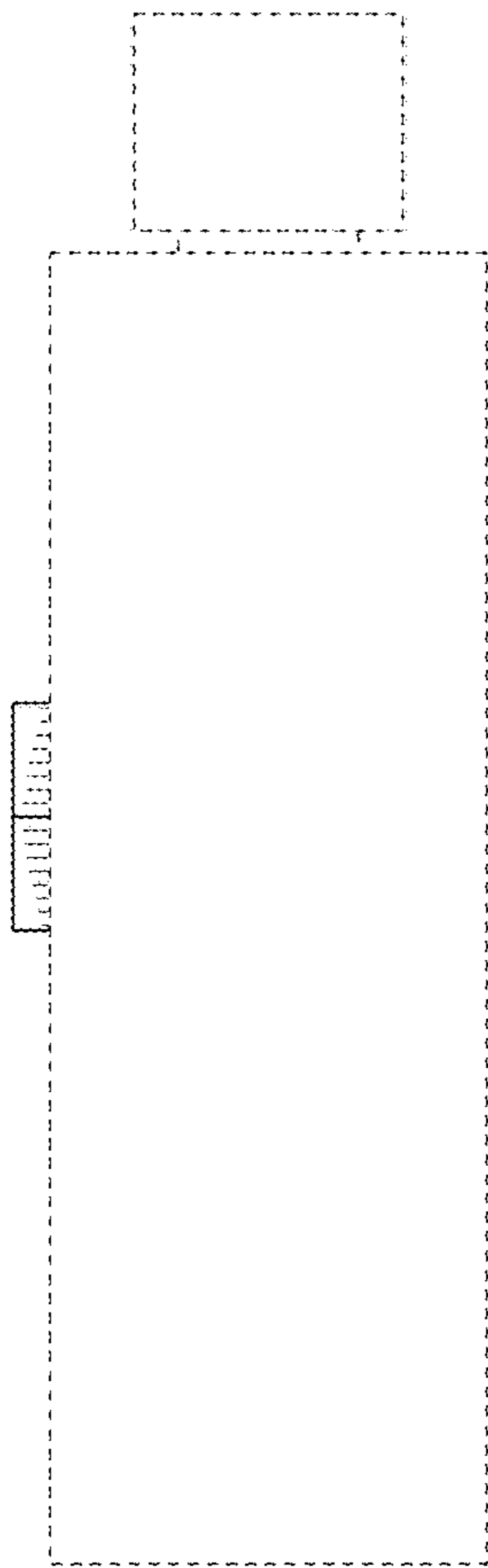

FIG. 5

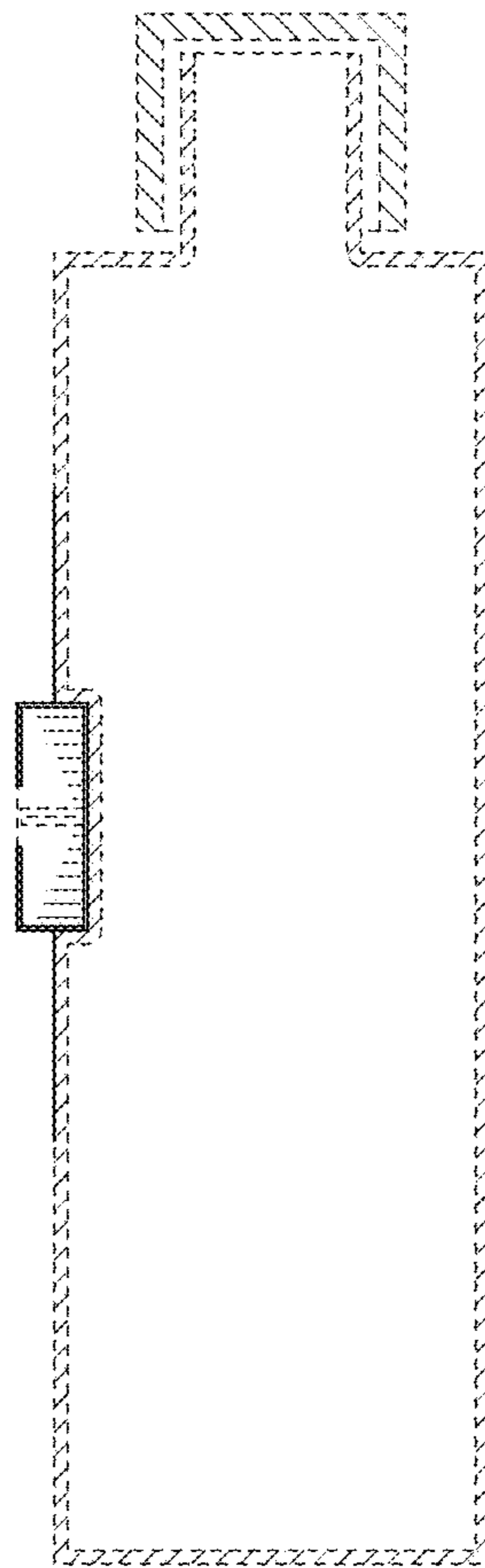

FIG. 6

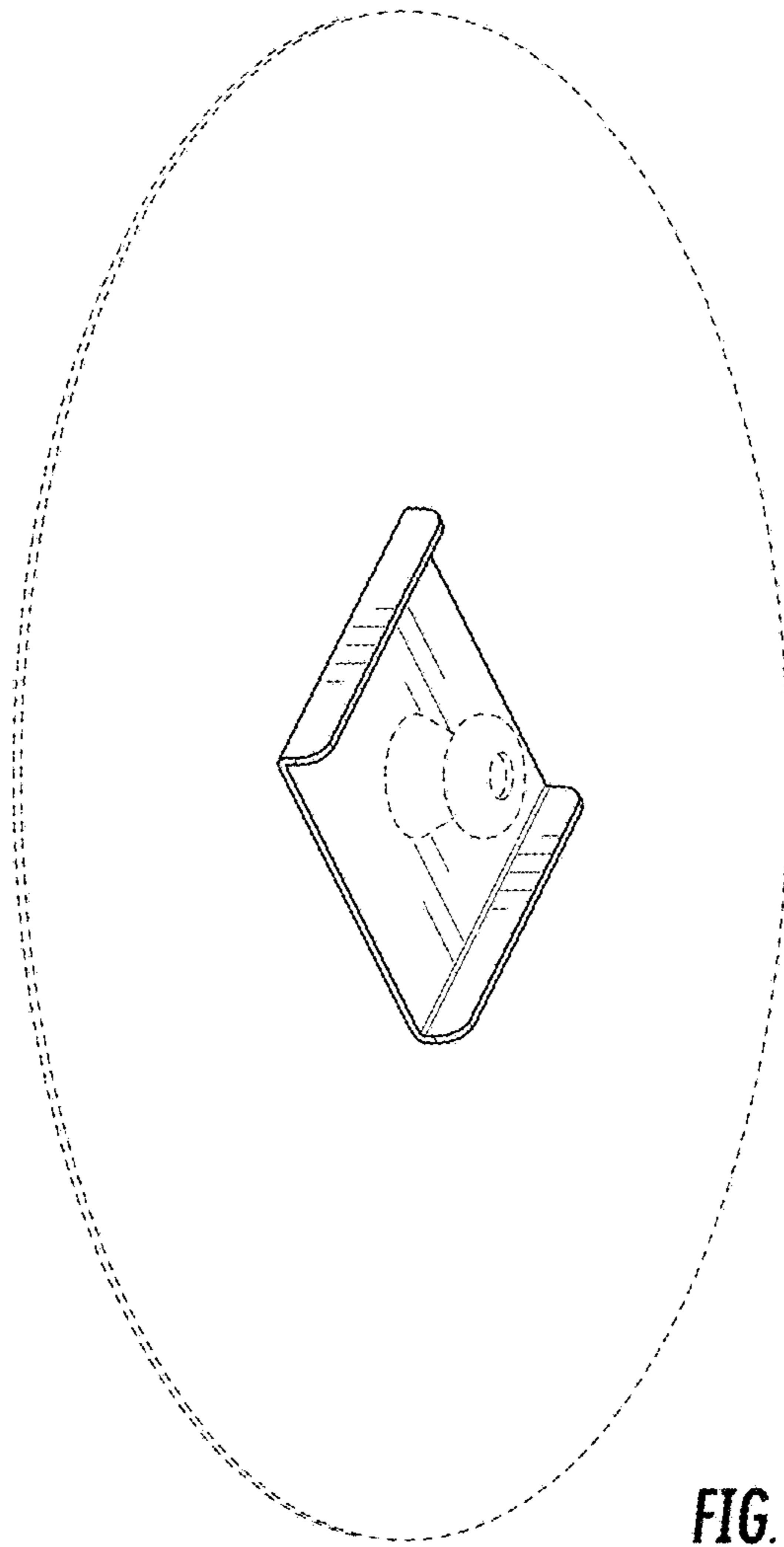

FIG. 7

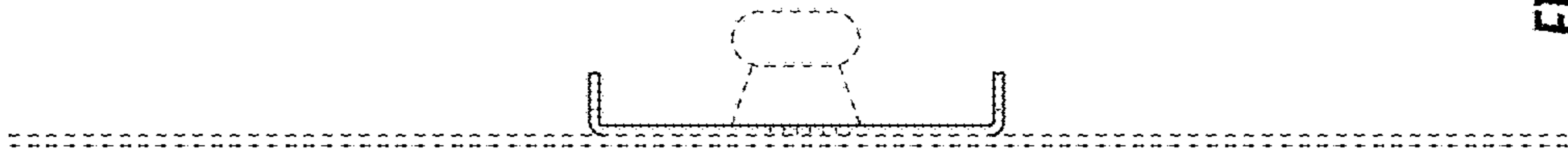

FIG. 9

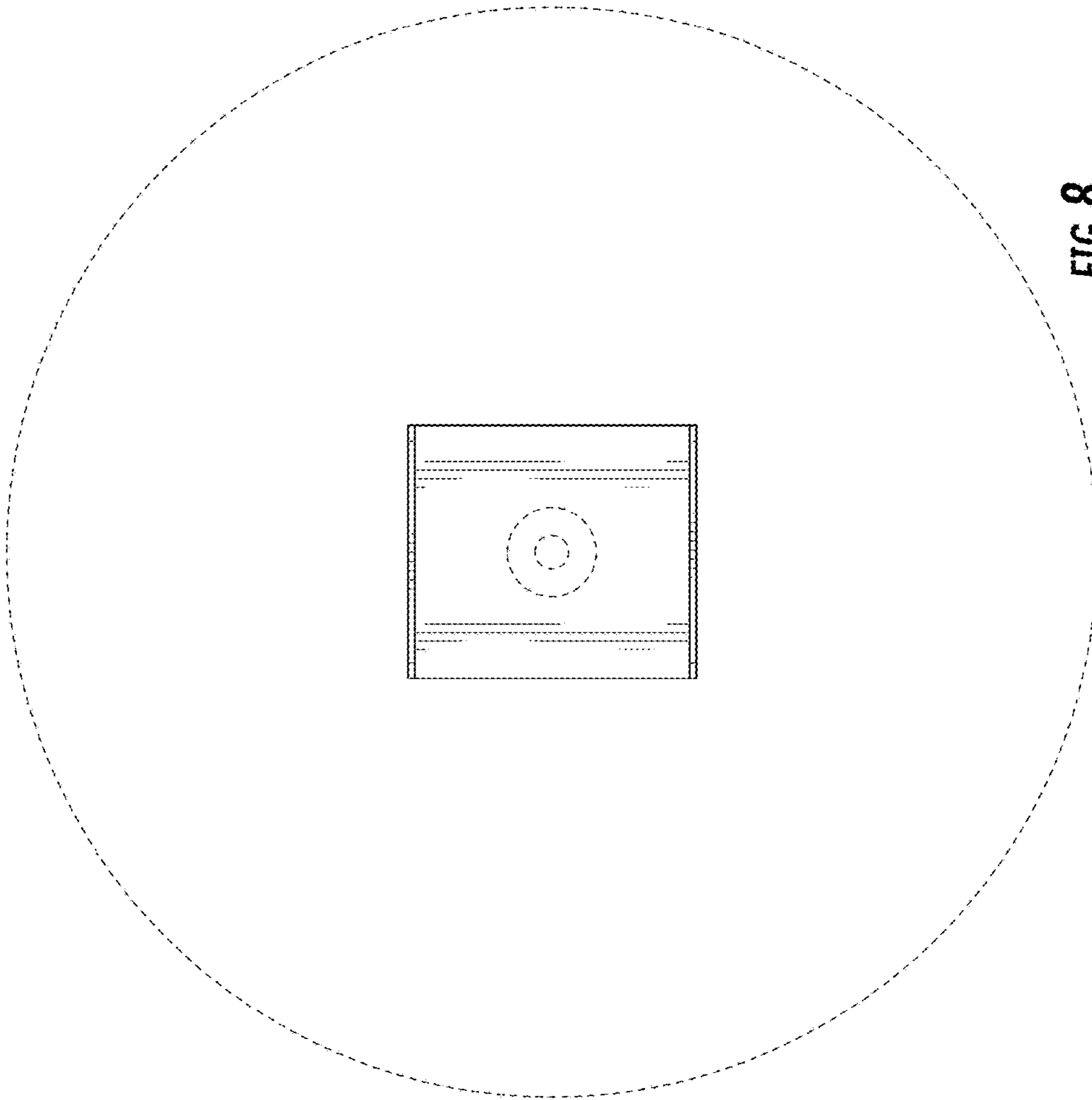
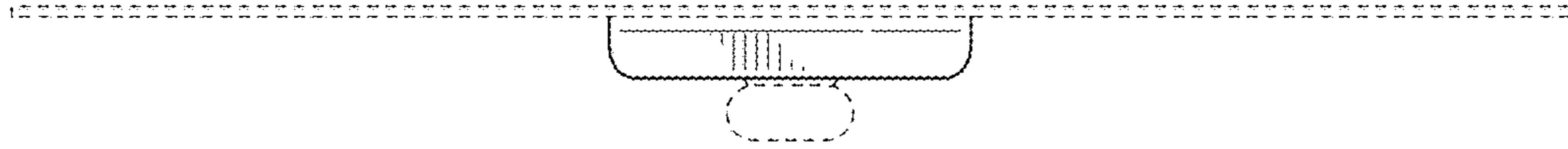
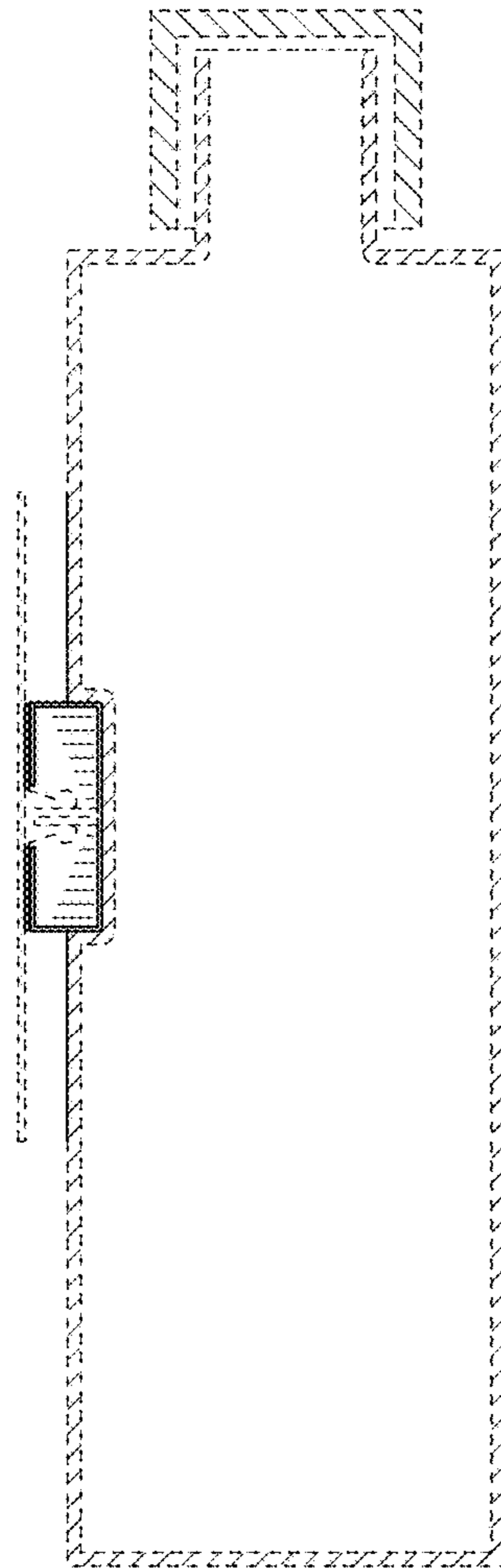

FIG. 8





**FIG. 10**



**FIG. 11**