



US00D836885S

(12) **United States Design Patent** (10) **Patent No.:** **US D836,885 S**
Goedde (45) **Date of Patent:** **** Jan. 1, 2019**

(54) **COSTUME**

(71) Applicant: **Suitables, Inc.**, Menlo Park, CA (US)

(72) Inventor: **Michael A. Goedde**, Menlo Park, CA (US)

(73) Assignee: **Suitables, Inc.**, Menlo Park, CA (US)

(**) Term: **15 Years**

(21) Appl. No.: **29/608,979**

(22) Filed: **Jun. 27, 2017**

(51) **LOC (11) Cl.** **02-02**

(52) **U.S. Cl.**
USPC **D2/741**

(58) **Field of Classification Search**
USPC D2/741
CPC .. A41D 13/1209; A41D 1/22; A41D 13/0015;
A41D 13/018; A41D 13/0543; A41D
13/0575; A41D 1/00; A41D 1/04; A41D
29/00; A41D 11/00; A41D 27/08; A41D
27/085; A41D 15/04; A41D 2400/42;
A41D 13/04; A41D 1/002; A41D
2300/324; A41D 2400/26; A41D 27/20;
A41D 27/28; A41D 31/00; A41D 3/08;
A63J 7/005

See application file for complete search history.

(56) **References Cited**

U.S. PATENT DOCUMENTS

535,908 A 3/1895 Kierolf
758,892 A * 5/1904 Bewsic A41D 1/04
2/102
984,735 A 2/1911 Bailey
3,042,399 A 7/1962 Lewendowski
3,099,443 A 7/1963 Koch
D253,417 S * 11/1979 Infante D21/445

(Continued)

OTHER PUBLICATIONS

Darth Vader TIE Fighter Rollstuhl, posted at drlima.net, posting date not given, [online], [site visited Sep. 10, 2018]. Available from Internet, URL: <https://drlima.net/2013/06/darth-vader-tie-fighter-rollstuhl/> (Year: 2018).*

(Continued)

Primary Examiner — George D. Kirschbaum

Assistant Examiner — Maria J Edwards

(74) *Attorney, Agent, or Firm* — Levine Bagade Han LLP

(57) **CLAIM**

The ornamental design for a costume, as shown and described.

DESCRIPTION

FIG. 1 is a perspective view of a costume, showing my new design;
FIG. 2 is a front view thereof;
FIG. 3 is a rear view thereof;
FIG. 4 is a left side view thereof;
FIG. 5 is a right side view thereof;
FIG. 6 is a bottom view thereof;
FIG. 7 is a top view thereof;
FIG. 8 is a rear perspective view thereof;
FIG. 9 is a dieline for a component thereof;
FIG. 10 is a dieline for a component thereof;
FIG. 11 is a dieline for a component thereof;
FIG. 12 is a dieline for a component thereof;
FIG. 13 is a dieline for a component thereof;
FIG. 14 is a dieline for a component thereof;
FIG. 15 is a dieline for a component thereof;
FIG. 16 is a dieline for a component thereof;
FIG. 17 is a dieline for a component thereof;
FIG. 18 is a dieline for a component thereof;
FIG. 19 is a dieline for a component thereof; and,
FIG. 20 is a dieline for a component thereof.
The broken lines in FIGS. 1-8 represent environment and form no part of the claimed design.

1 Claim, 14 Drawing Sheets

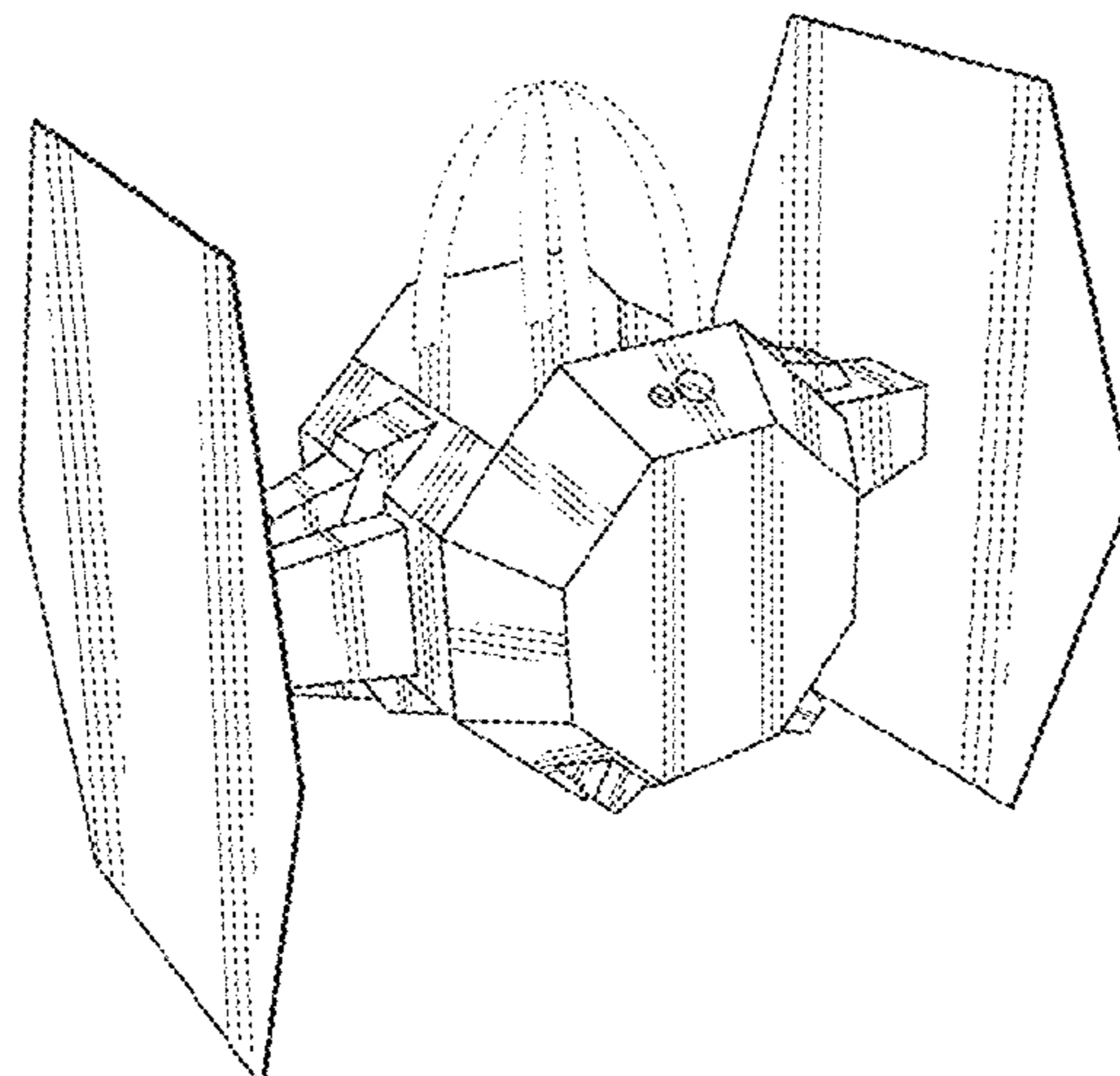

(56)

References Cited

U.S. PATENT DOCUMENTS

D254,816 S * 4/1980 Sloan D2/741
 D272,839 S * 2/1984 Jennings D21/451
 D277,116 S * 1/1985 Johnston 244/45 R
 D288,945 S * 3/1987 Rodis-Jamero D21/451
 D288,946 S * 3/1987 Rodis-Jamero D21/451
 5,022,681 A 6/1991 Penick
 D328,618 S * 8/1992 Wiley D2/741
 5,162,010 A 11/1992 Krebs
 5,320,065 A 6/1994 Leopold
 5,562,520 A 10/1996 Pridonoff et al.
 D537,876 S 3/2007 Balzer
 7,552,563 B2 6/2009 Becker
 8,234,835 B2 8/2012 Dye et al.
 8,286,266 B2 10/2012 Berman
 D689,952 S * 9/2013 De La Torre D21/436
 9,072,980 B2 7/2015 van Tilburg
 2011/0016601 A1 1/2011 Berman

2011/0281495 A1 11/2011 Welsh et al.
 2011/0281496 A1 11/2011 Welsh et al.
 2012/0015582 A1 1/2012 van Tilburg
 2015/0038246 A1 2/2015 Zeid

OTHER PUBLICATIONS

Kid TIE fighter costume, posted at photobucket.com, posting date not given, [online], [site visited Sep. 10, 2018]. Available from Internet, URL: <http://photobucket.com/gallery/user/SweetLisaK/media/cGF0aDovY2FyZGJvYXJkZmx5ZXIzX3pwcwz5MGZhNjYyLmpwZw==/> (Year: 2018).*

Two guys TIE fighter, posted at flickr.com, posting date Jul. 25, 2008, [online], [site visited Sep. 10, 2018]. Available from Internet, URL: <https://www.flickr.com/photos/lildamselfly/2721602980/> (Year: 2008).*

Flat Out Frankie Web Catalogue Apr. 15, 2016 (2014_web).

* cited by examiner

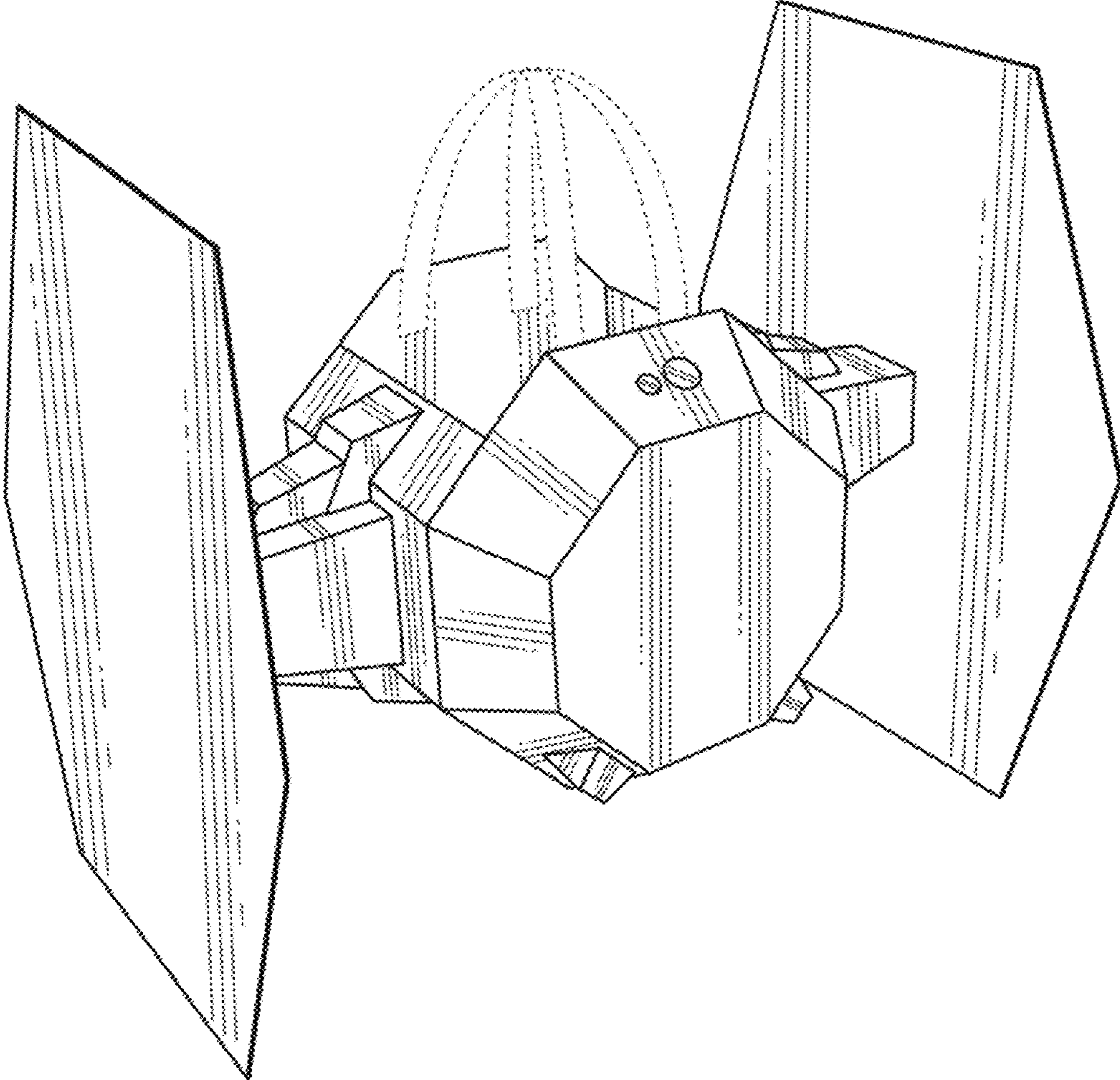

FIG. 1

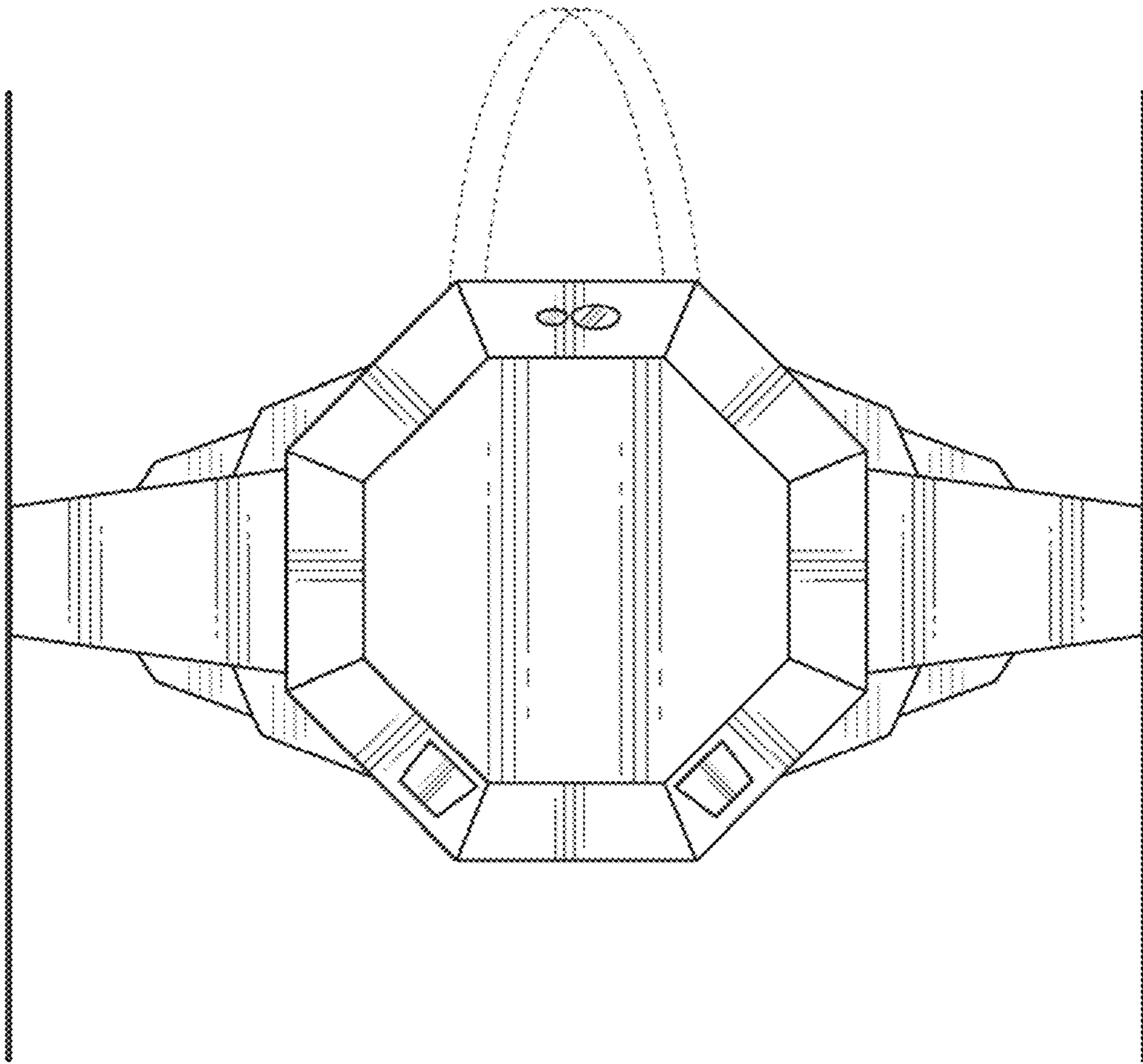

FIG. 2

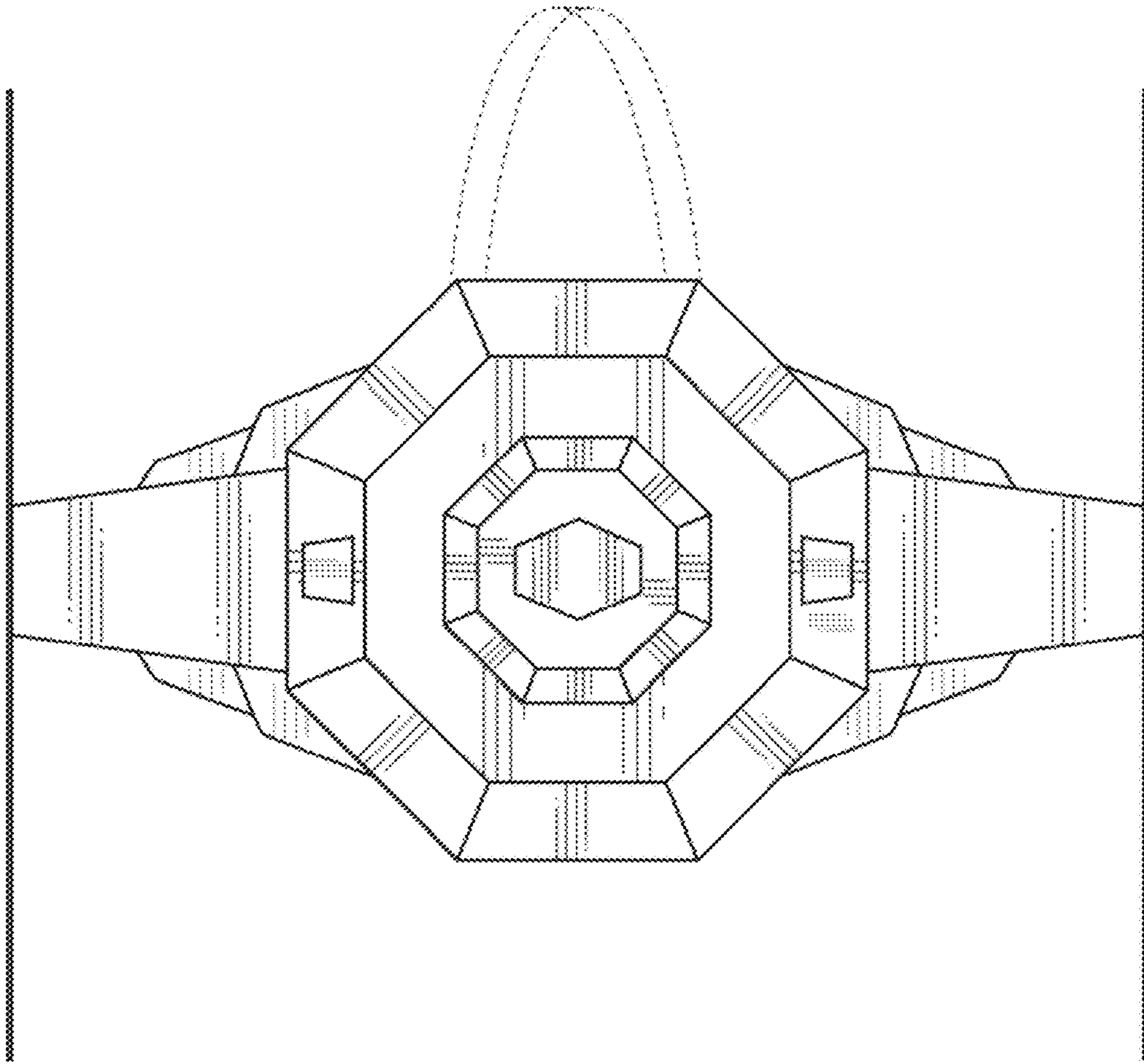

FIG. 3

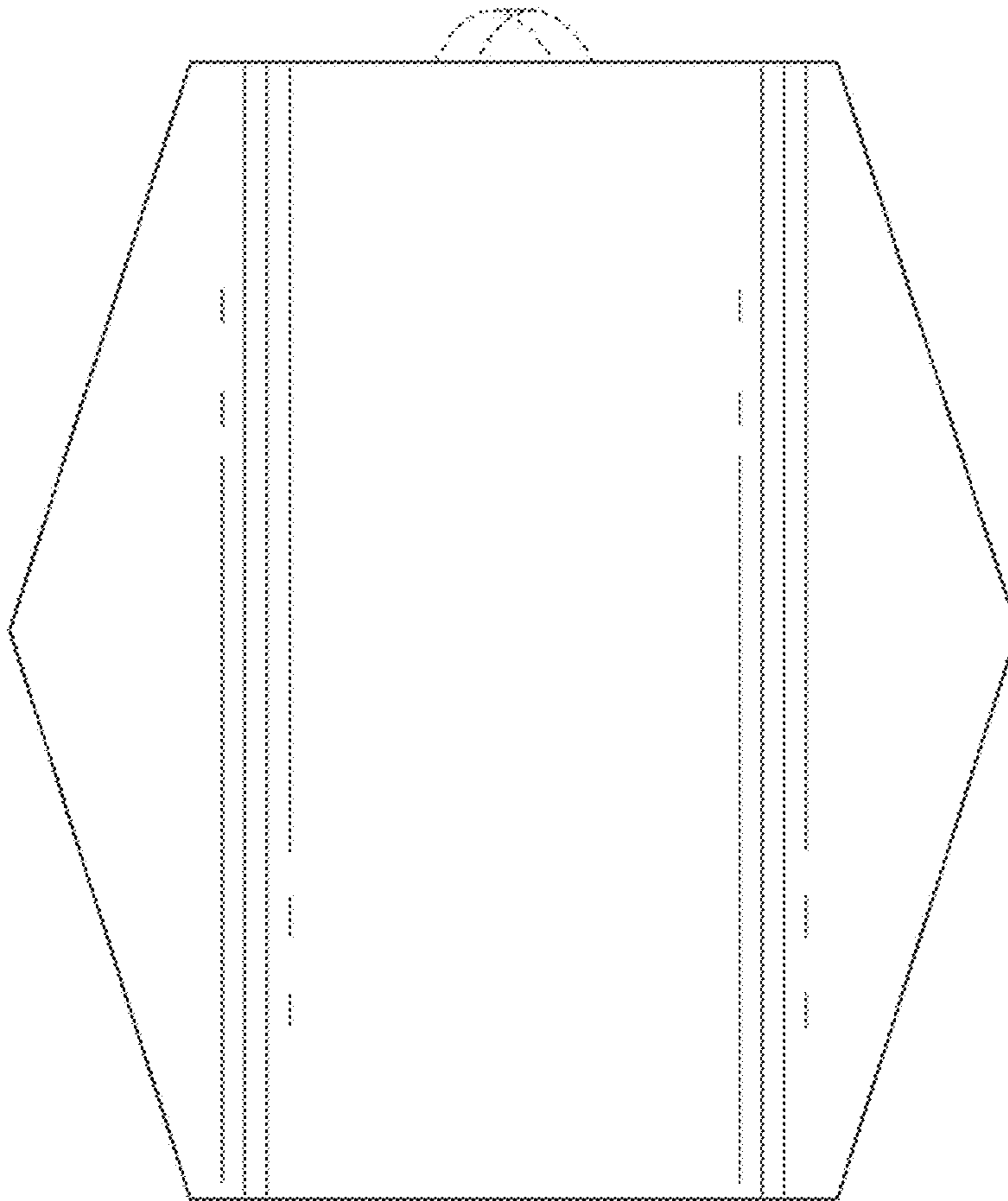

FIG. 4

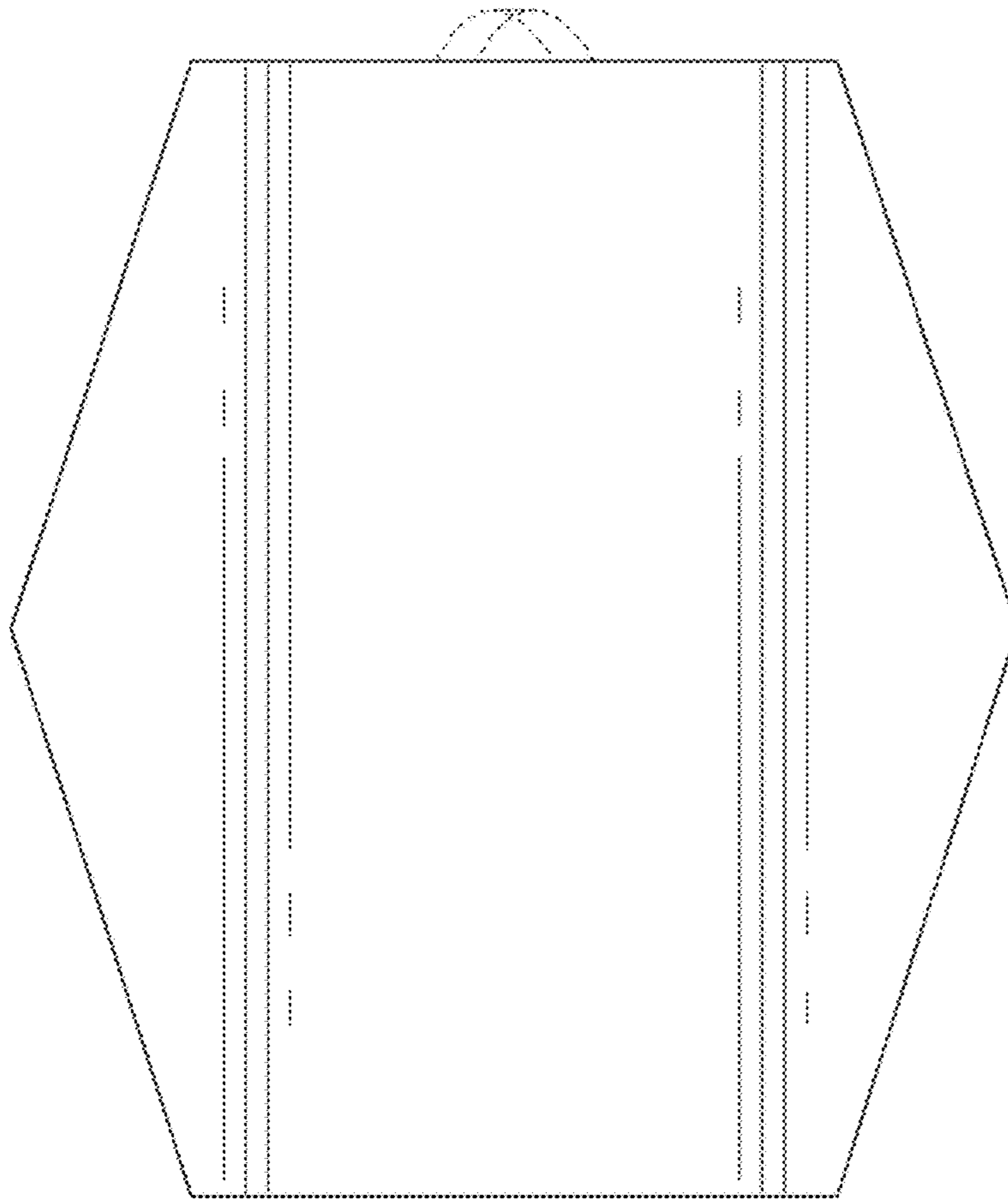

FIG. 5

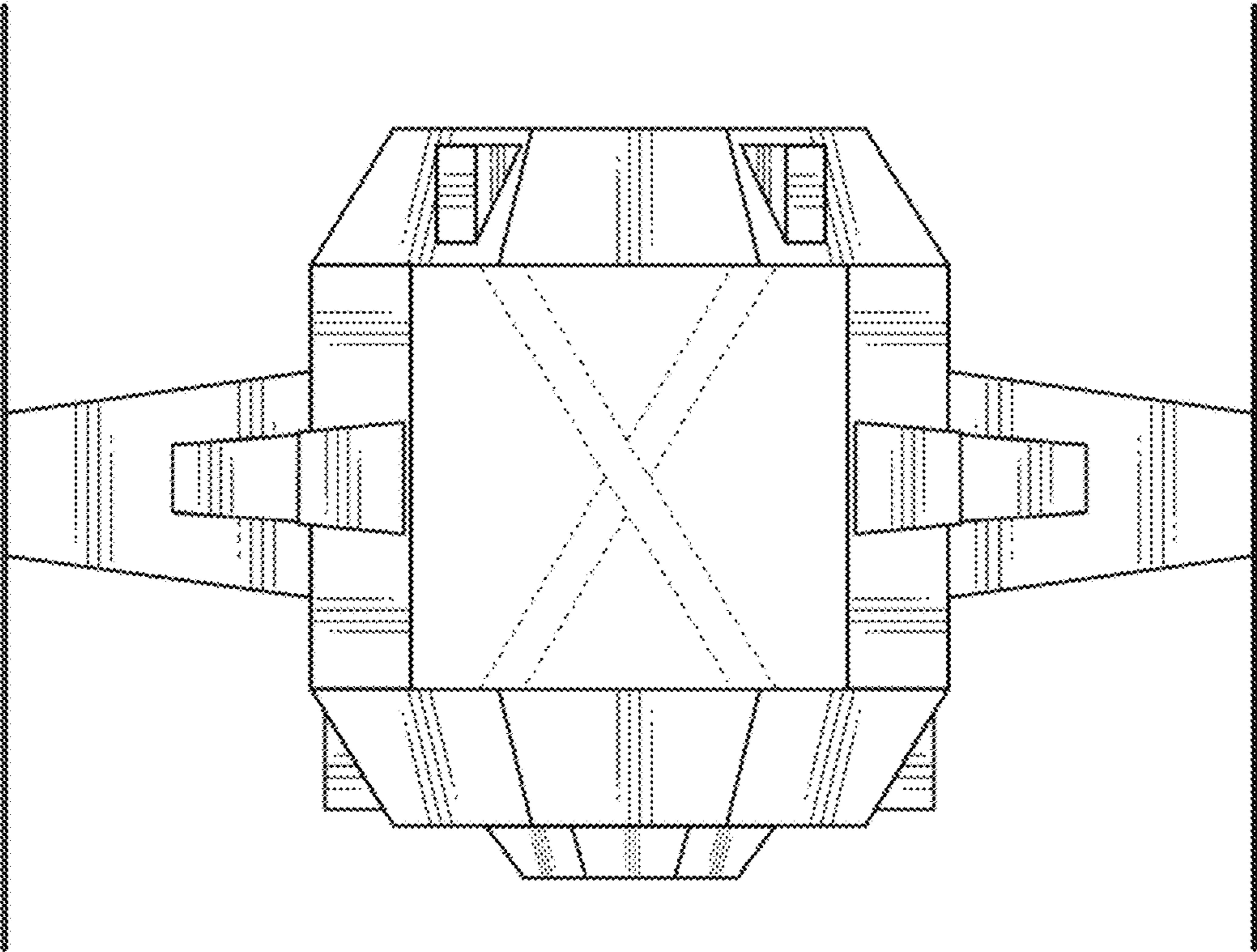

FIG. 6

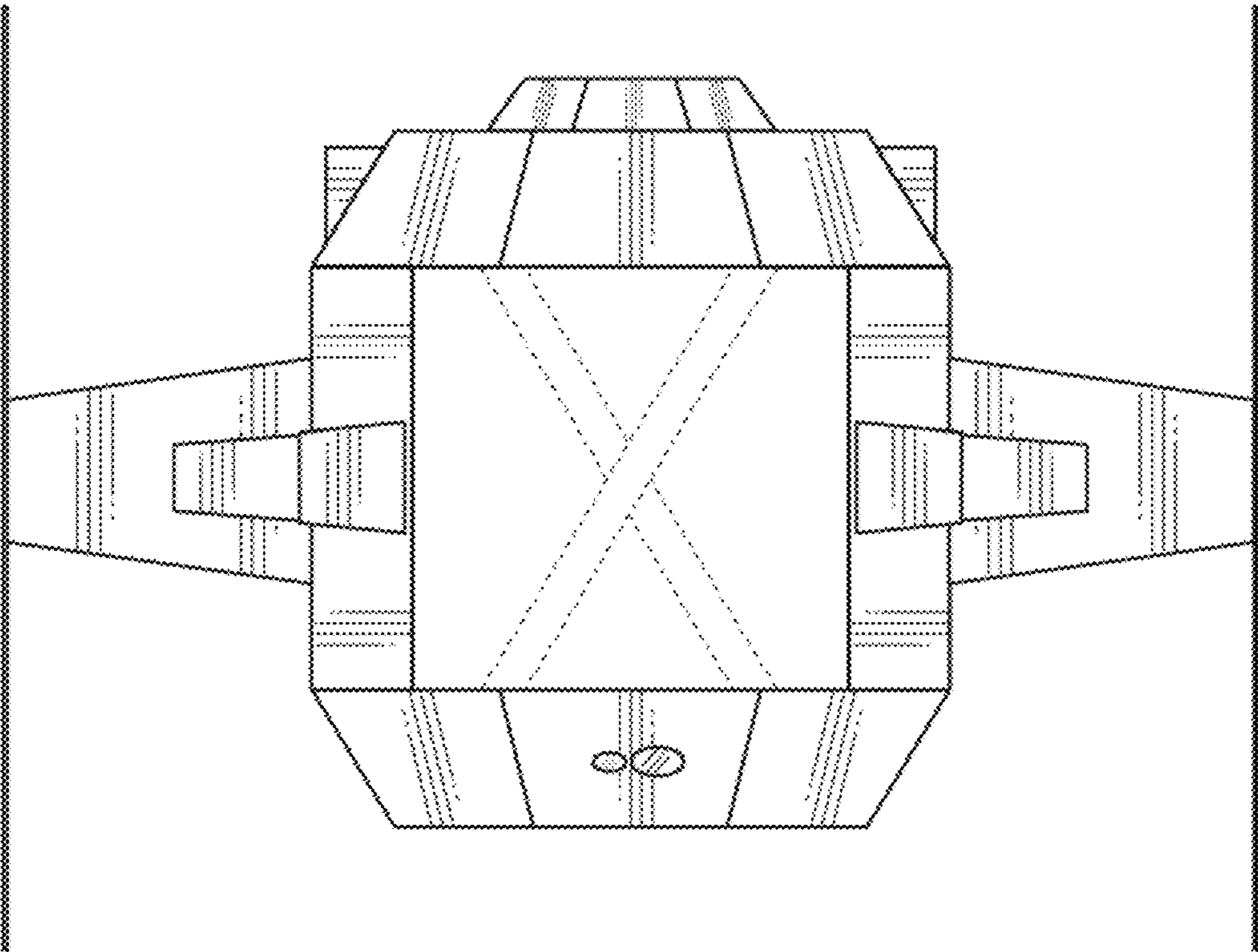

FIG. 7

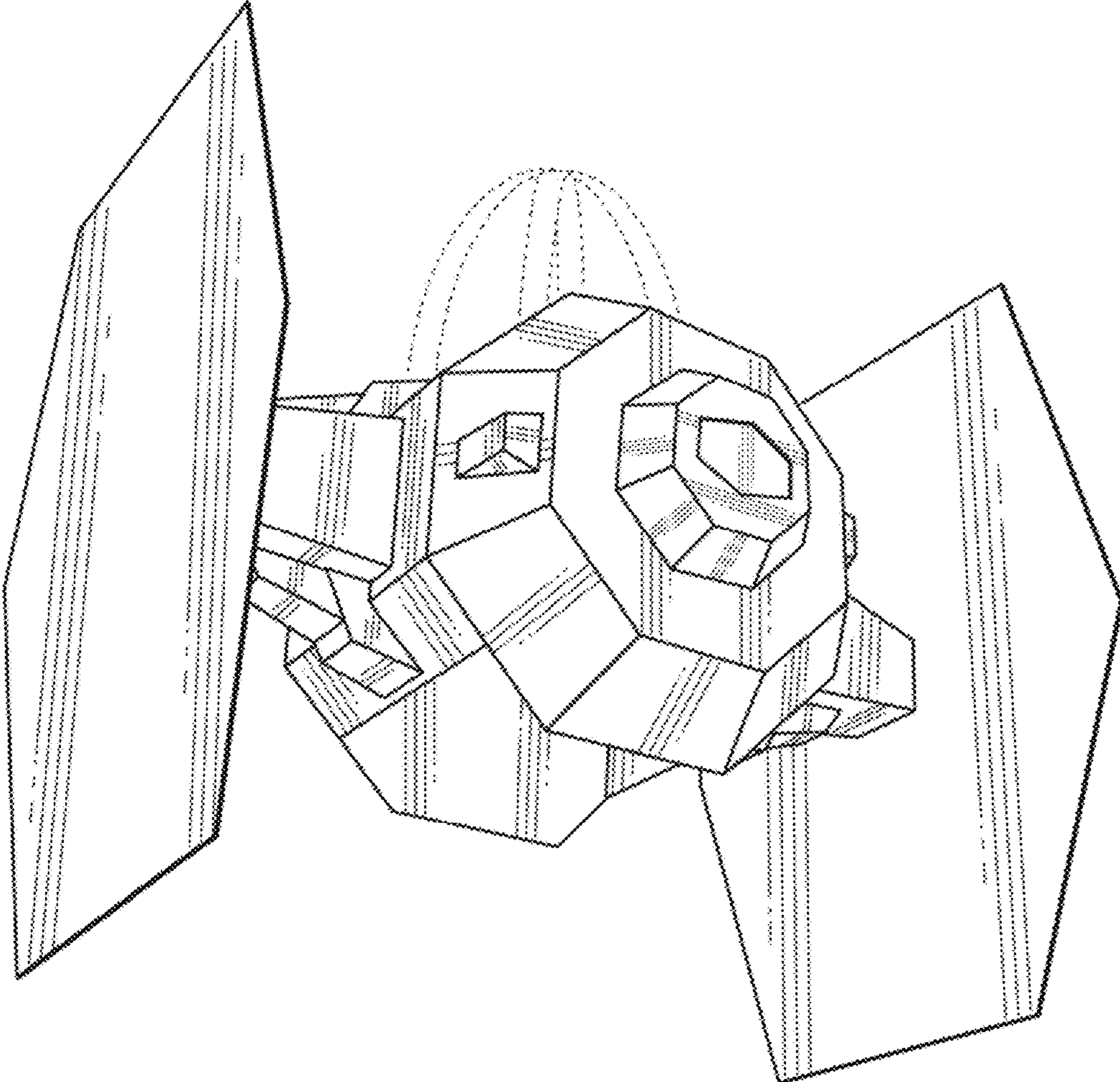

FIG. 8

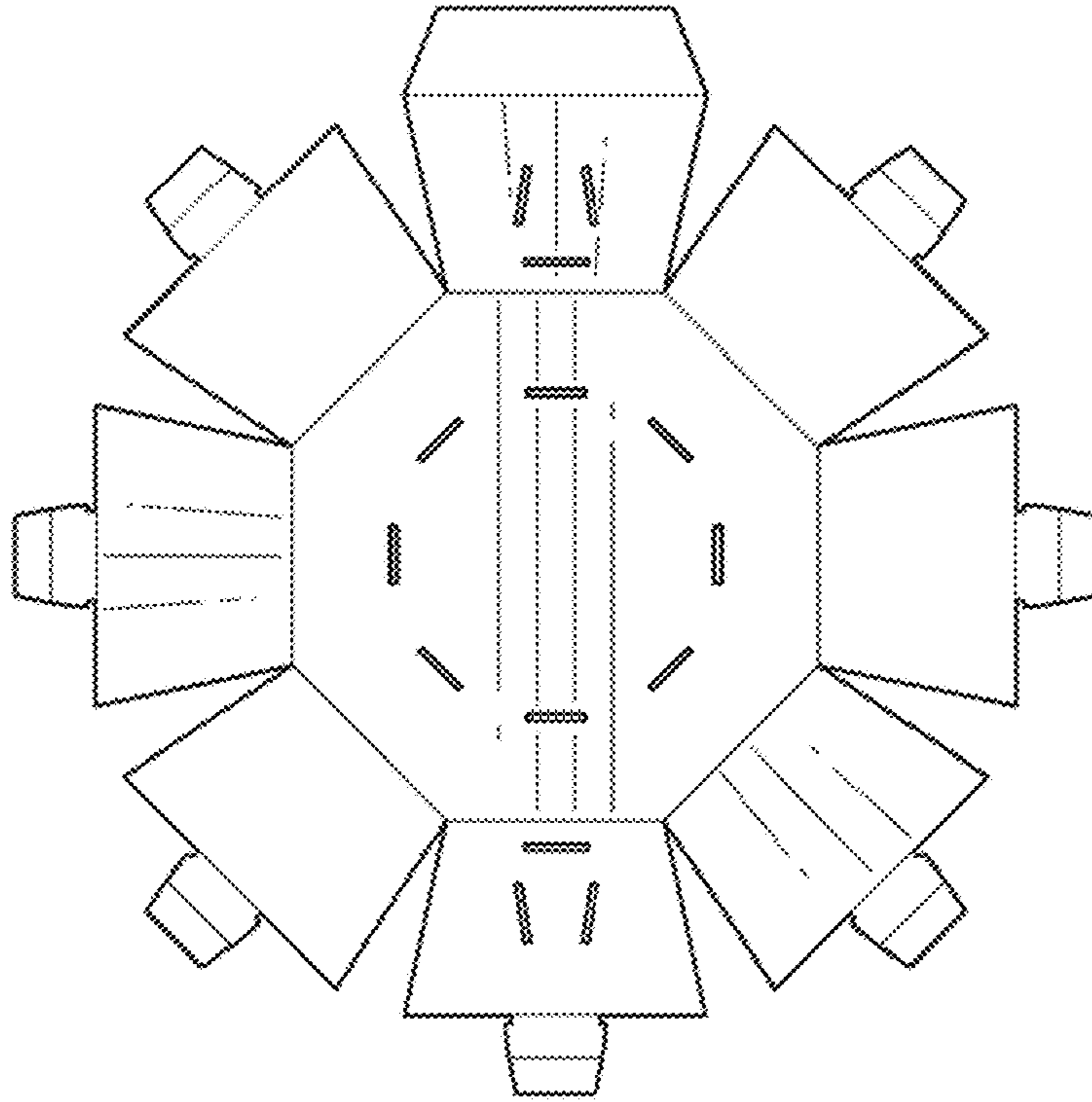

FIG. 9

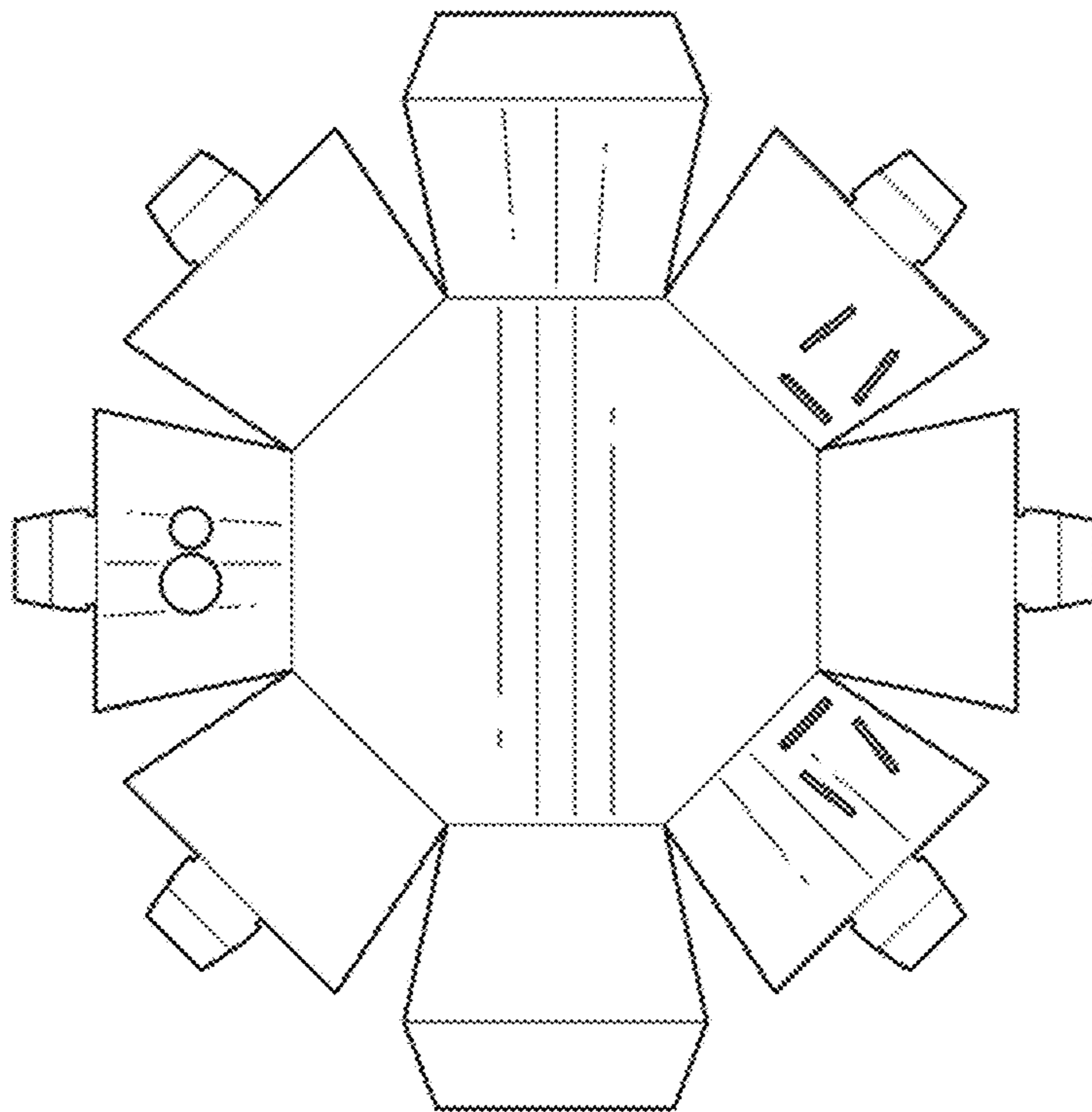

FIG. 10

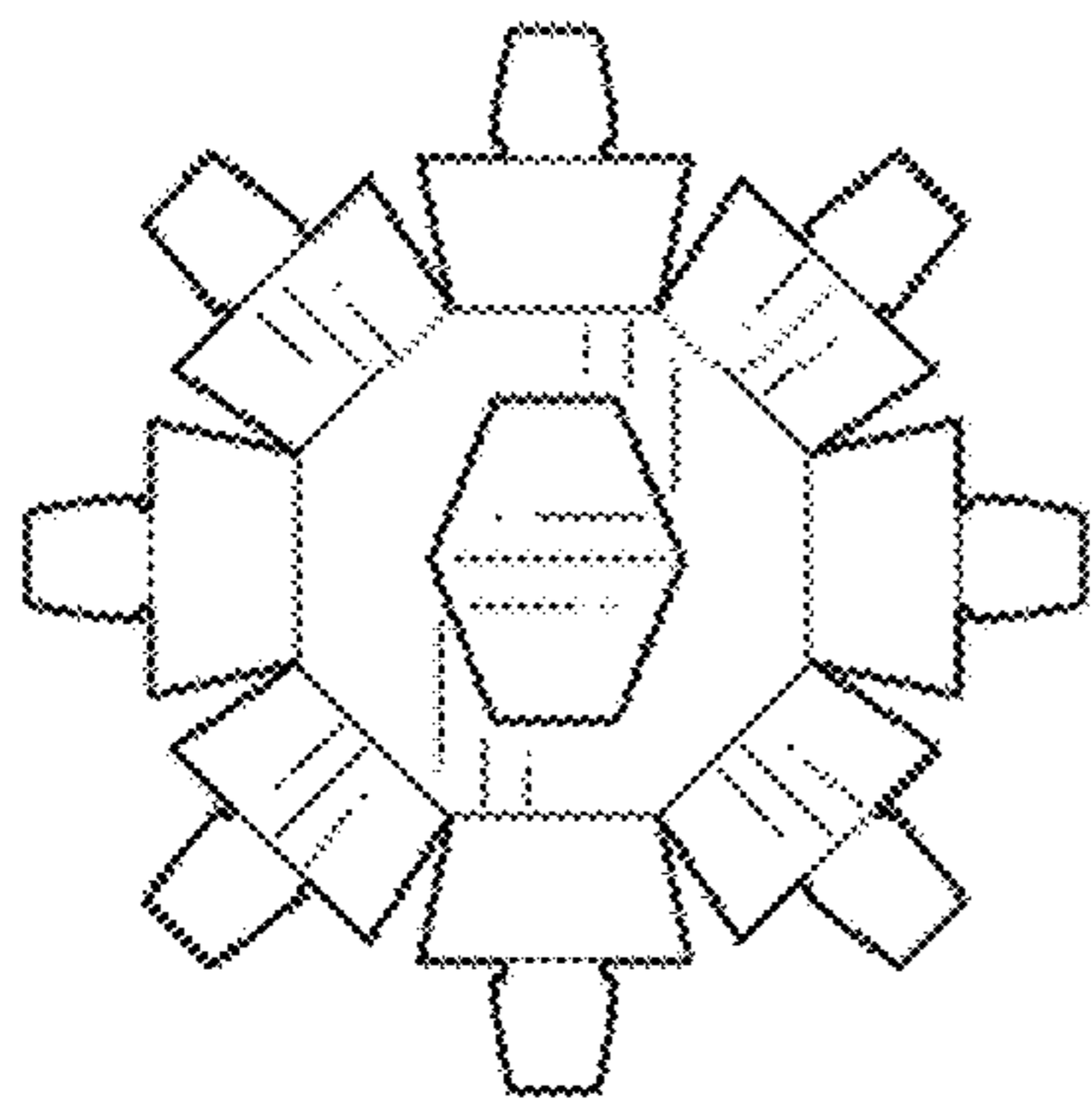

FIG. 11

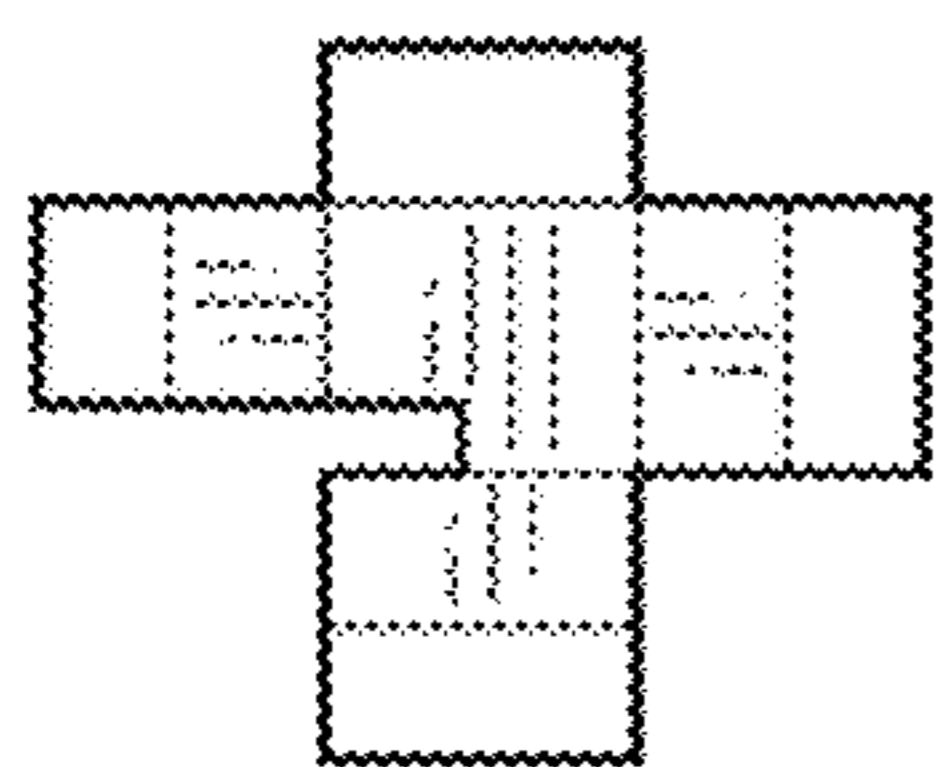

FIG. 12

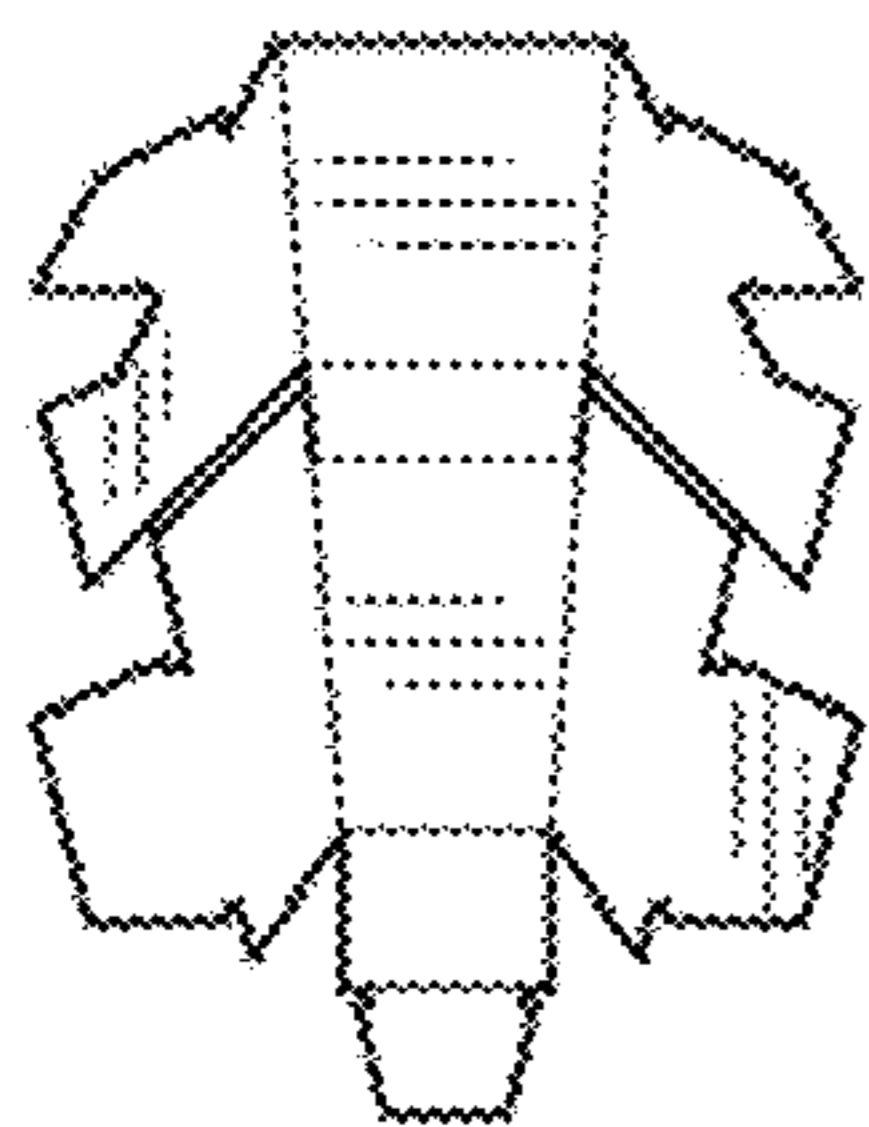

FIG. 13

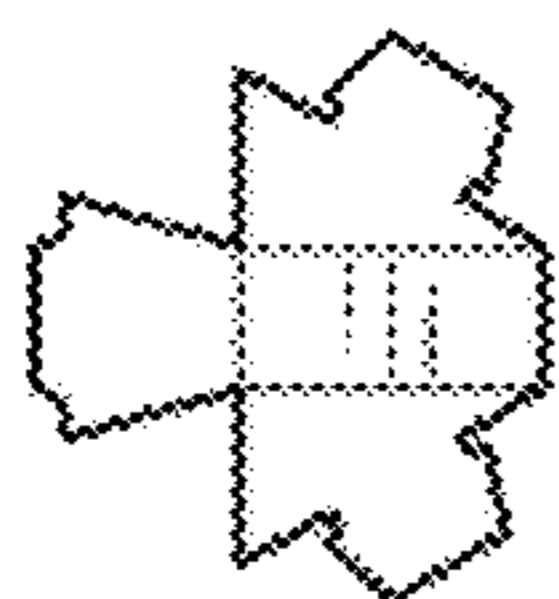

FIG. 14

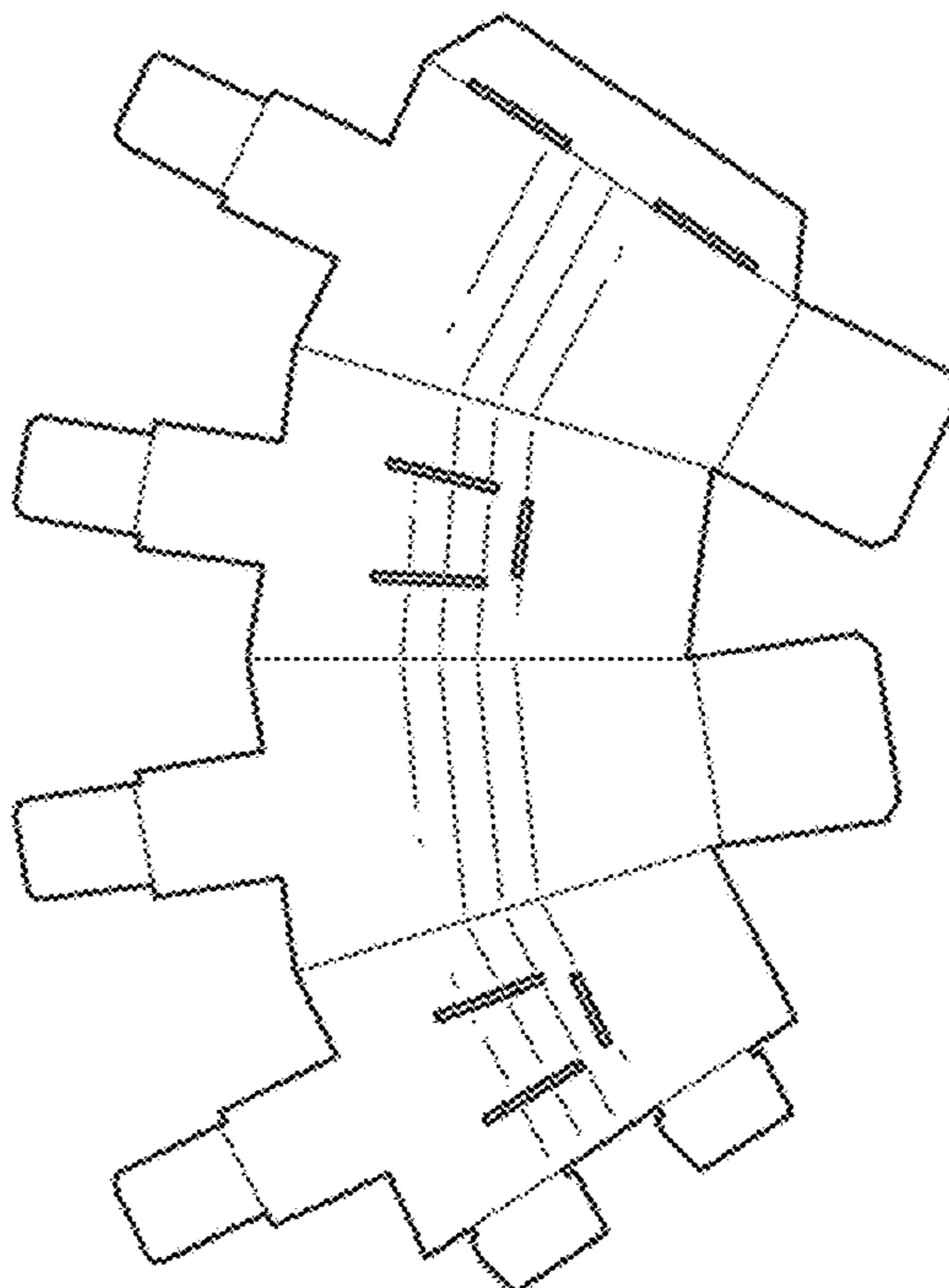

FIG. 15

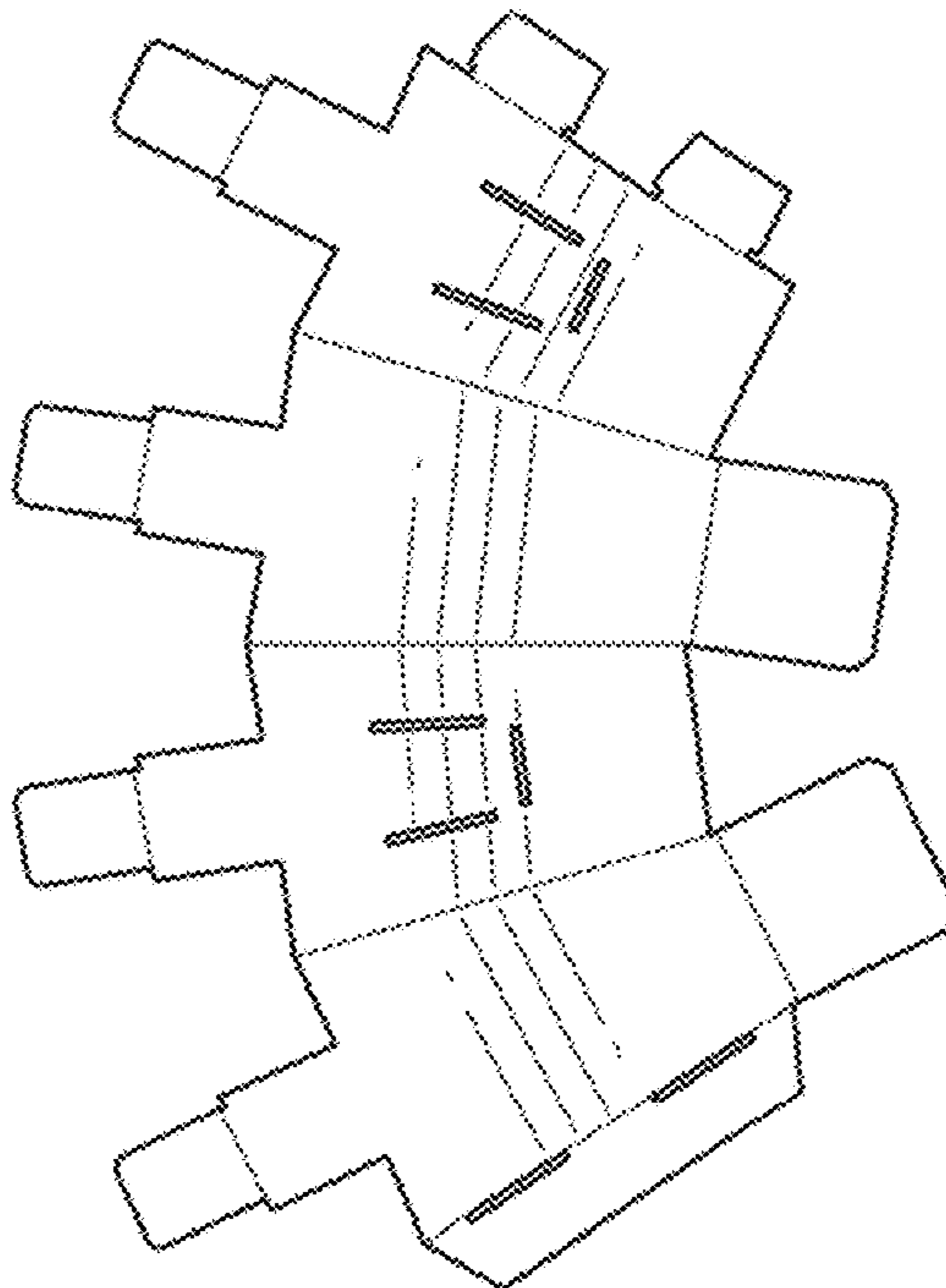

FIG. 16

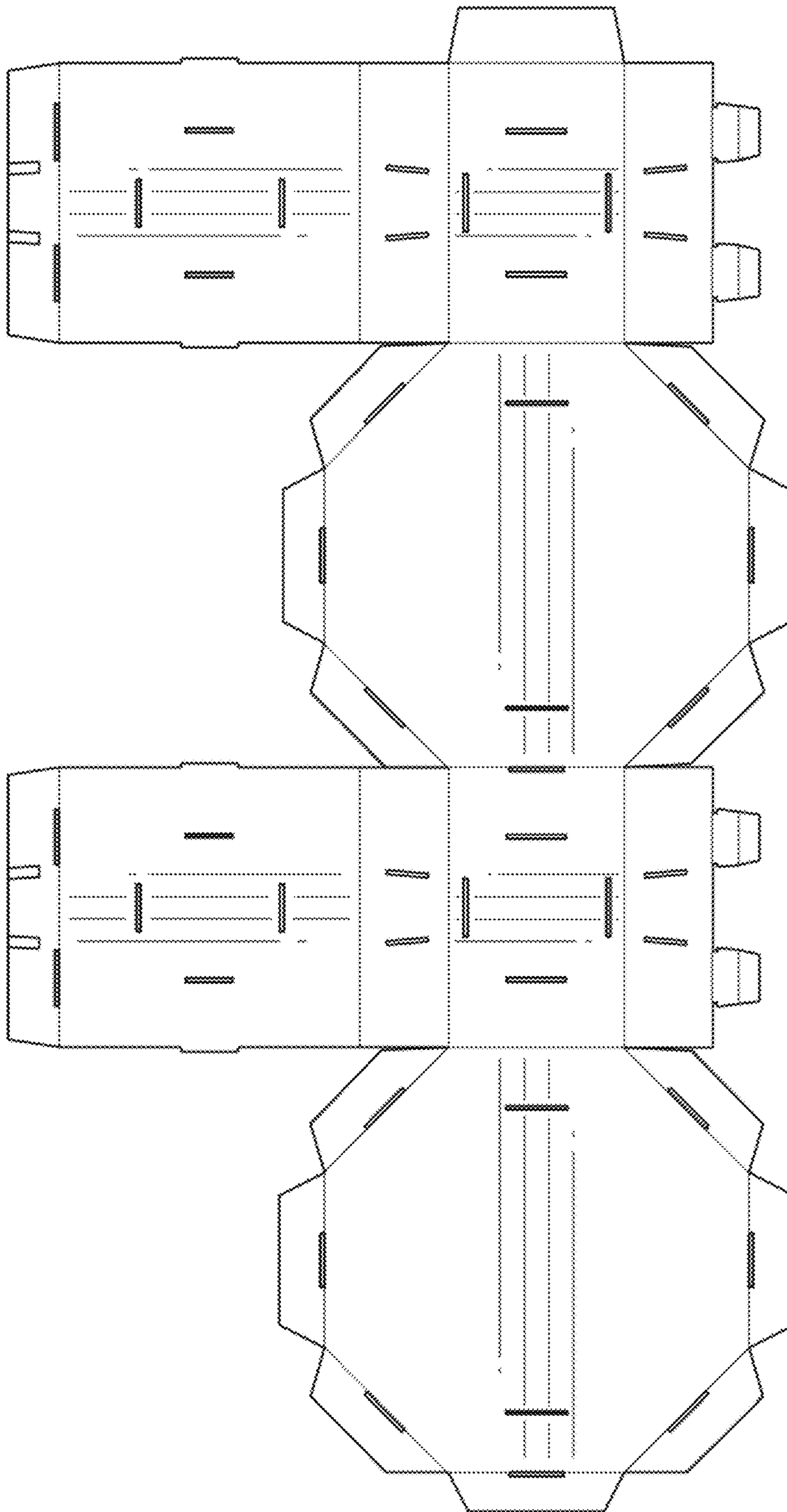

FIG. 17

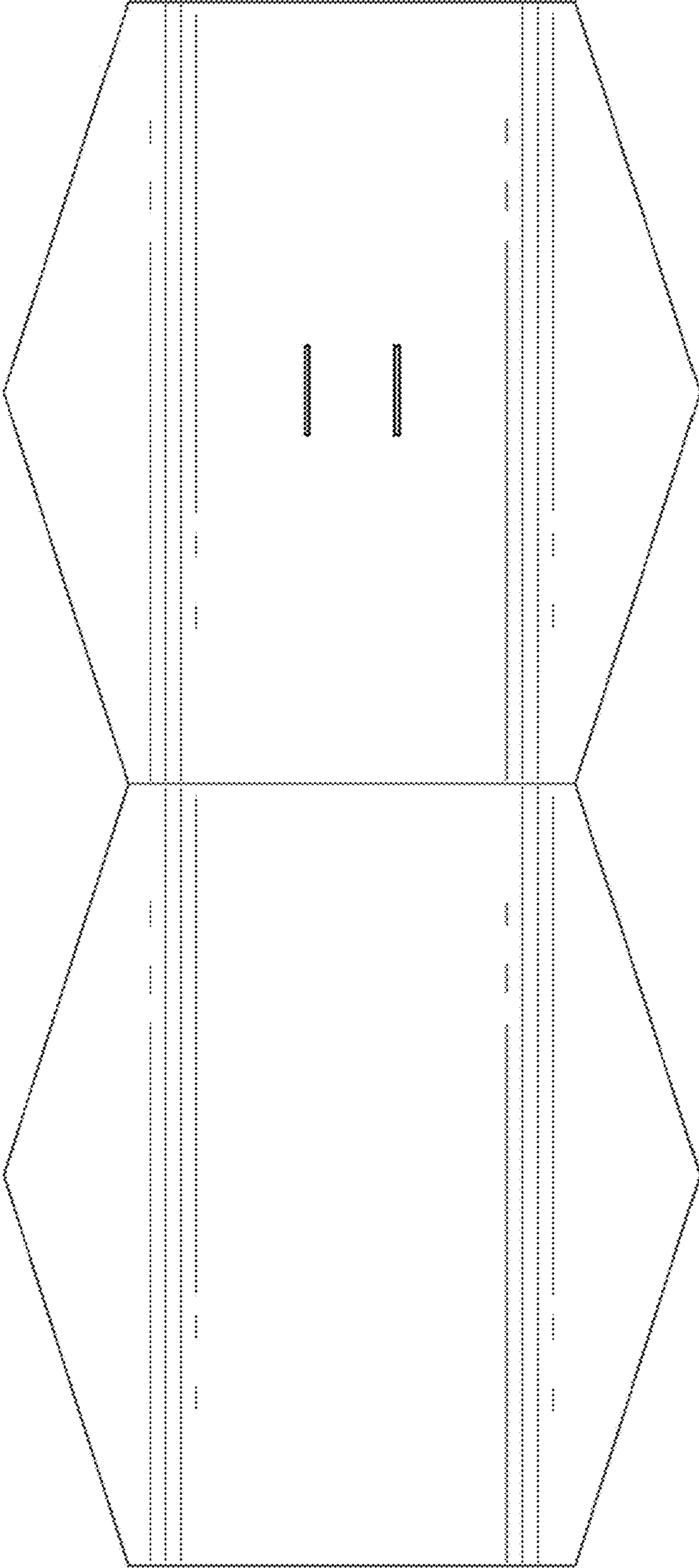

FIG. 18

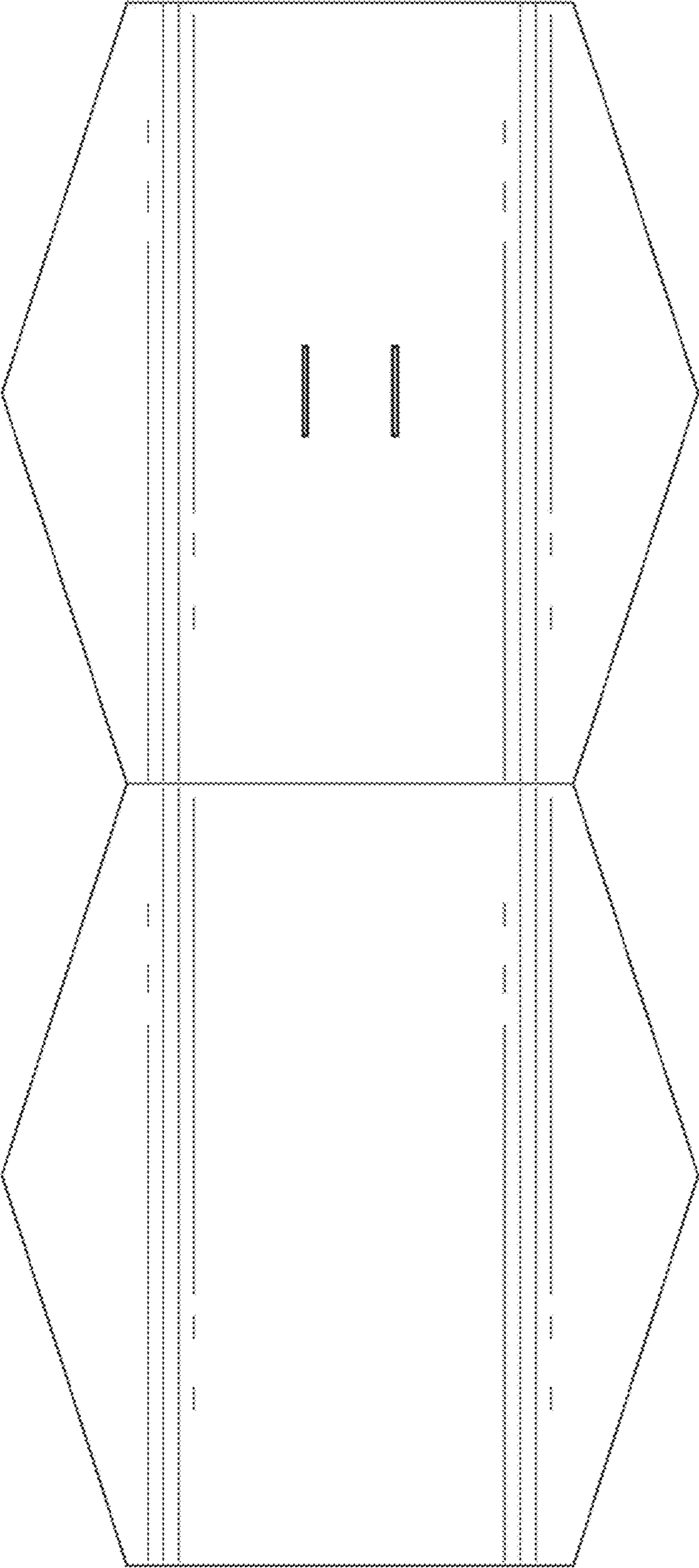

FIG. 19

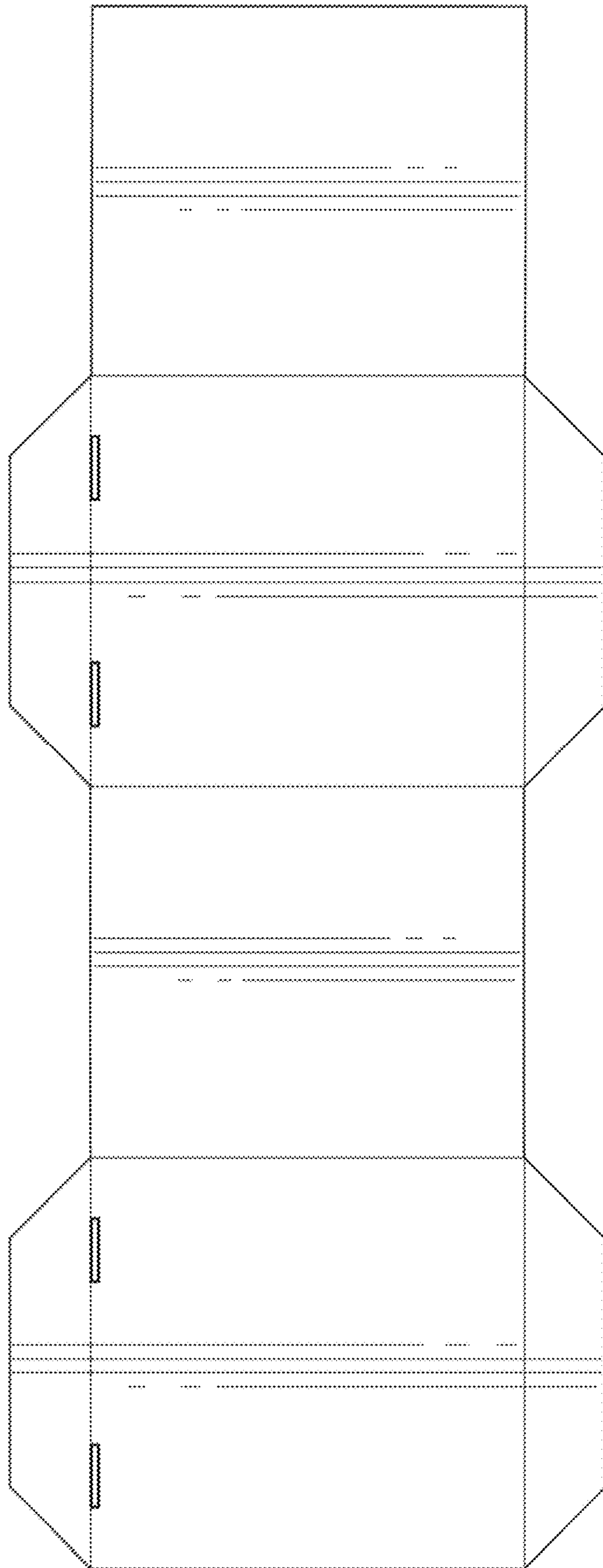

FIG. 20