



US00D836846S

(12) **United States Design Patent** (10) **Patent No.:** **US D836,846 S**
Shiffer (45) **Date of Patent:** **** Dec. 25, 2018**

(54) **BICYCLE HELMET**

(71) Applicant: **memBrain Safety Solutions, LLC**, Los Angeles, CA (US)

(72) Inventor: **Isis Alexandra Shiffer**, Brooklyn, NY (US)

(73) Assignee: **memBrain Safety Solutions, LLC**, Los Angeles, CA (US)

(**) Term: **15 Years**

(21) Appl. No.: **29/617,264**

(22) Filed: **Sep. 13, 2017**

Related U.S. Application Data

(63) Continuation-in-part of application No. 29/612,613, filed on Aug. 2, 2017, which is a continuation of application No. 29/593,908, filed on Feb. 14, 2017, which is a continuation-in-part of application No. 29/582,807, filed on Oct. 31, 2016, now Pat. No. Des. 806,317.

(51) **LOC (11) Cl.** **09-03**

(52) **U.S. Cl.**
USPC **D29/102**

(58) **Field of Classification Search**
USPC D29/102-107, 122
CPC A42B 3/166; A42B 3/222; A42B 3/321; A42B 3/127; A42B 3/125; A42B 3/128; A42B 3/0433; A42B 3/0453; A42B 3/046; A42B 3/00; A42B 3/22; A42B 3/30; A42B 3/283; A42B 3/303; A42B 3/306; A63B 71/10; G06F 3/017; G06F 3/005; G06F 3/012

See application file for complete search history.

(56) **References Cited**

U.S. PATENT DOCUMENTS

3,026,525	A *	3/1962	Gyorfy	A42B 3/225
				2/202
3,514,787	A *	6/1970	Kennedy, Jr.	A42B 3/322
				2/410
3,991,422	A *	11/1976	Saotome	A42B 3/322
				2/410
4,607,397	A *	8/1986	Laxo	A42B 3/322
				2/410
5,116,288	A *	5/1992	Kondo	A45B 23/00
				135/135

(Continued)

Primary Examiner — Ruth McInroy

(74) *Attorney, Agent, or Firm* — RMCK Law Group PLC

(57) **CLAIM**

The ornamental design for a bicycle helmet, as shown and described.

DESCRIPTION

FIG. 1 is a top perspective view of a bicycle helmet in an operational condition showing my new design; FIG. 2 is a bottom perspective view thereof; FIG. 3 is a front view thereof; FIG. 4 is a right side view thereof; FIG. 5 is a rear view thereof; FIG. 6 is a left side view thereof; FIG. 7 is a top view thereof; FIG. 8 is a bottom view thereof; FIG. 9 is a top perspective view of a second embodiment thereof, shown in a collapsed condition; FIG. 10 is a bottom perspective view of FIG. 9; FIG. 11 is a front view of FIG. 9; FIG. 12 is a rear view of FIG. 9; FIG. 13 is a left side view of FIG. 9; FIG. 14 is right side view of FIG. 9; FIG. 15 is a top view of FIG. 9; and, FIG. 16 is a bottom view of FIG. 9. The details shown in broken lines form no part of the claimed design.

1 Claim, 14 Drawing Sheets

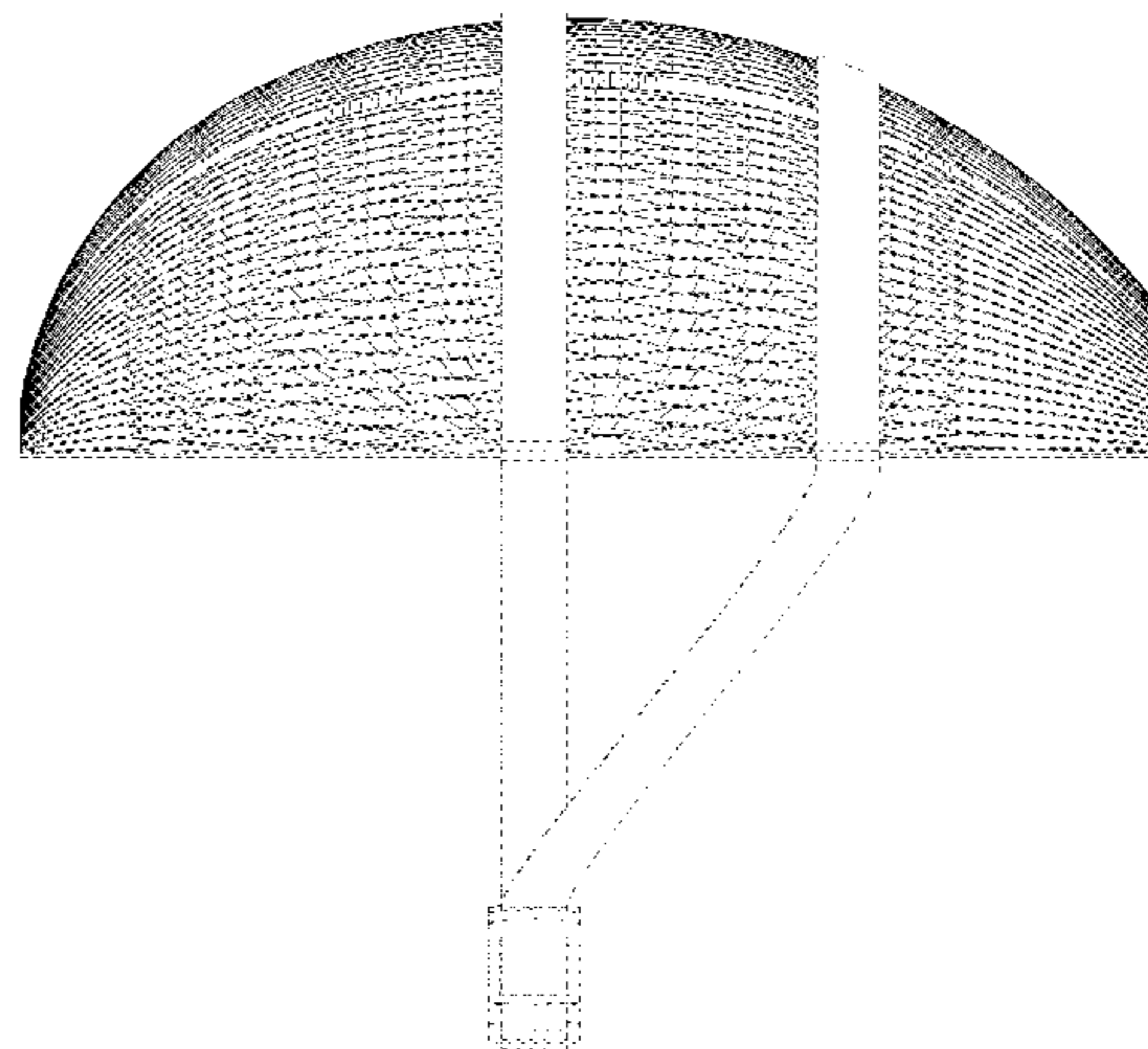
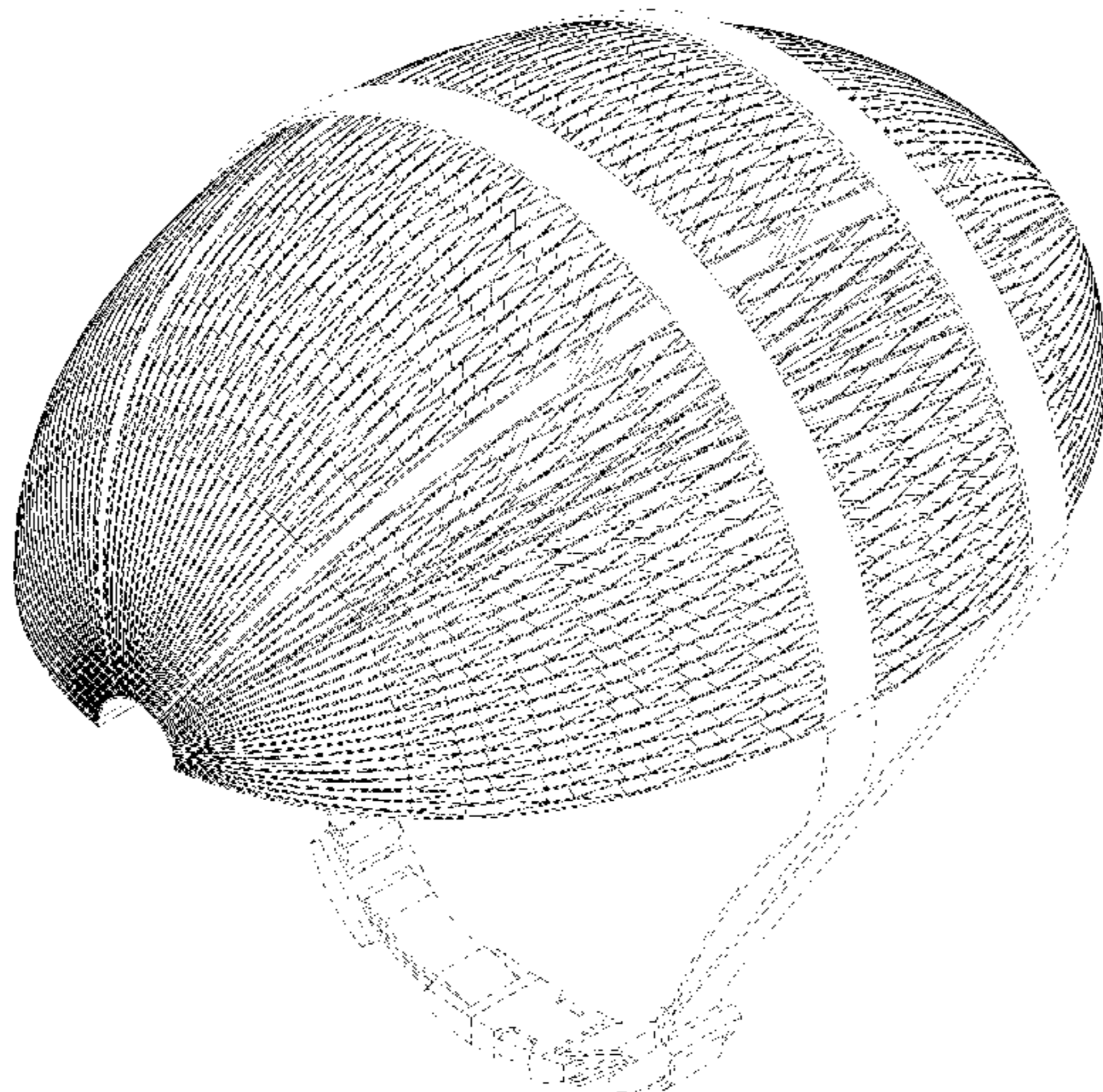

(56)

References Cited

U.S. PATENT DOCUMENTS

5,515,546 A * 5/1996 Shifrin A42B 3/00
2/209.11
5,628,071 A * 5/1997 Nezer A42B 3/322
2/410
5,896,590 A * 4/1999 Fleisch A42B 3/322
2/410
7,845,025 B2 * 12/2010 Tovo A42B 3/328
2/410
7,958,572 B2 * 6/2011 Loury A42B 3/322
2/410
D697,267 S * 1/2014 Benvegnu D29/102
D697,272 S * 1/2014 Moffa D29/122
D774,256 S * 12/2016 Katopis D29/102
9,642,409 B2 * 5/2017 Roesler A42B 1/08
9,675,127 B2 * 6/2017 Guadagnin A42B 3/322

* cited by examiner

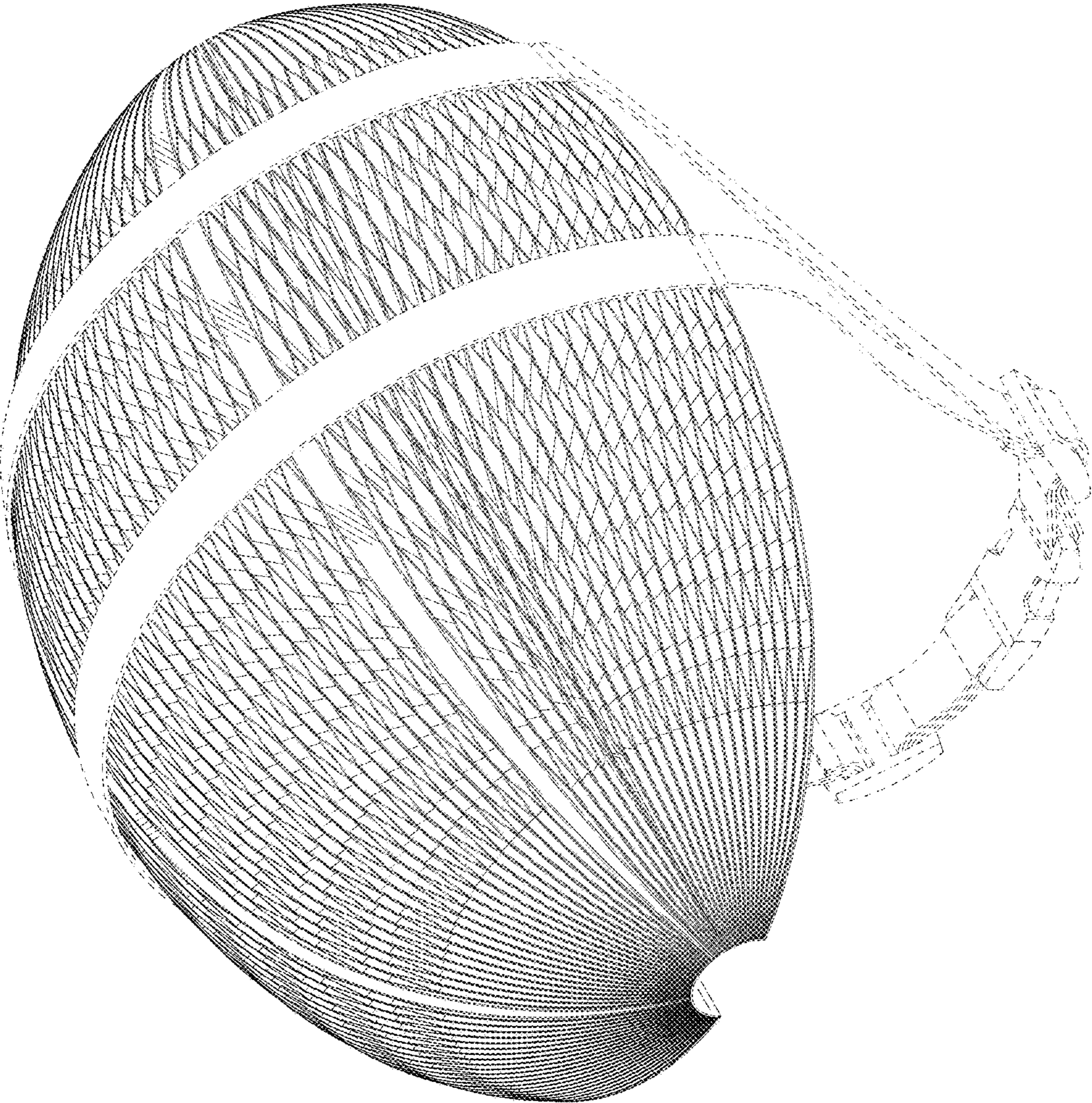

FIG. 1

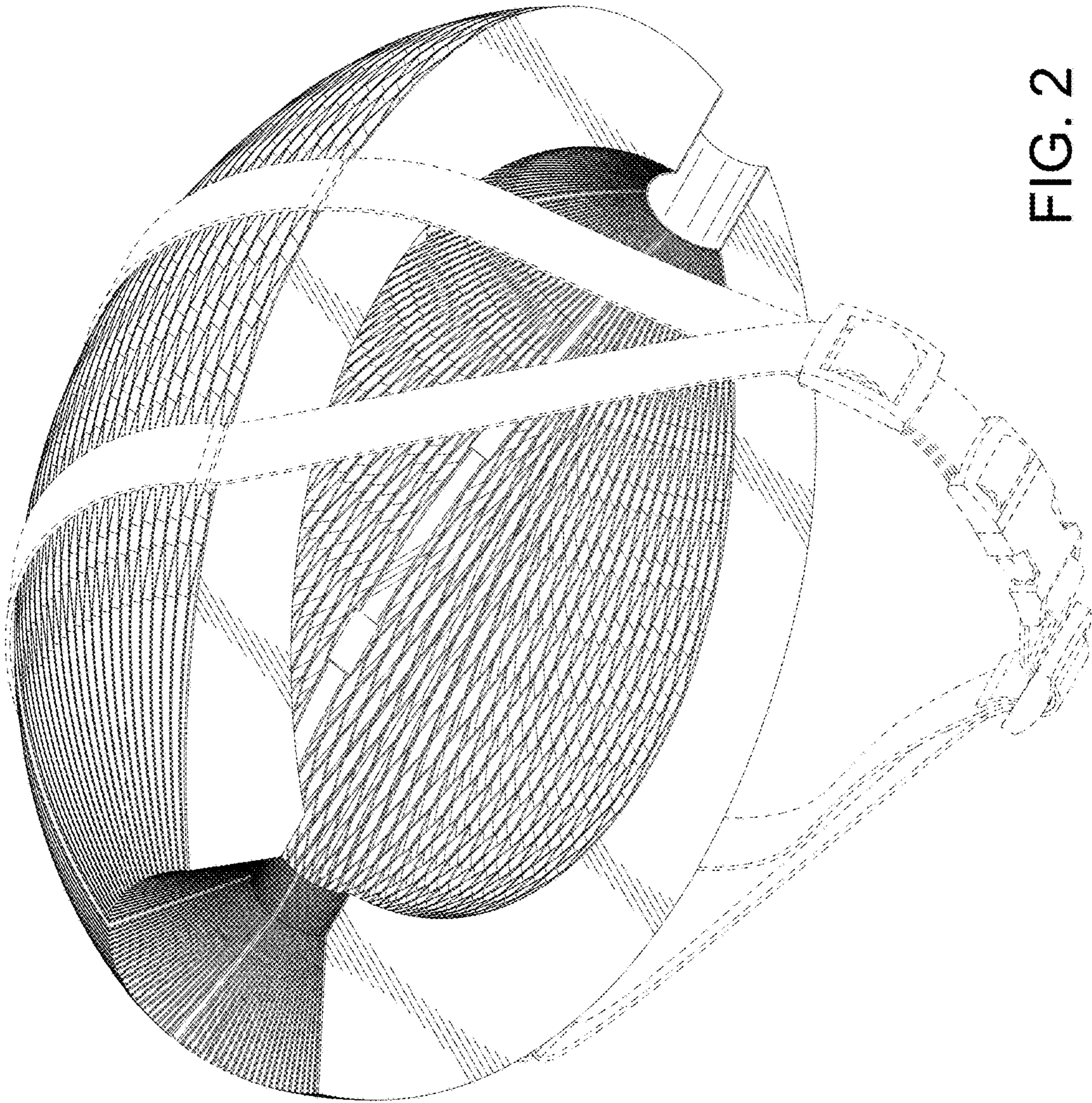

FIG. 2

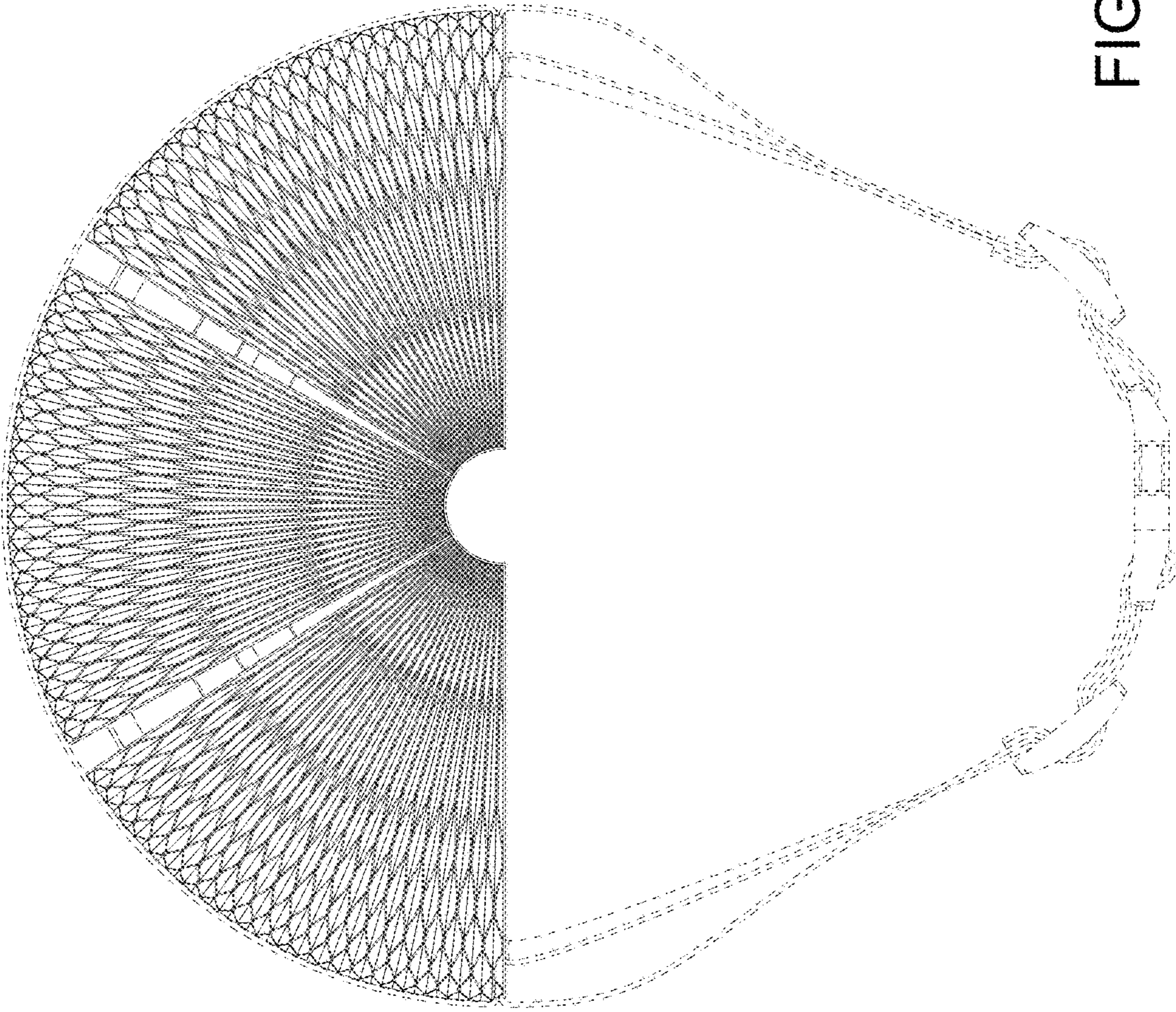

FIG. 3

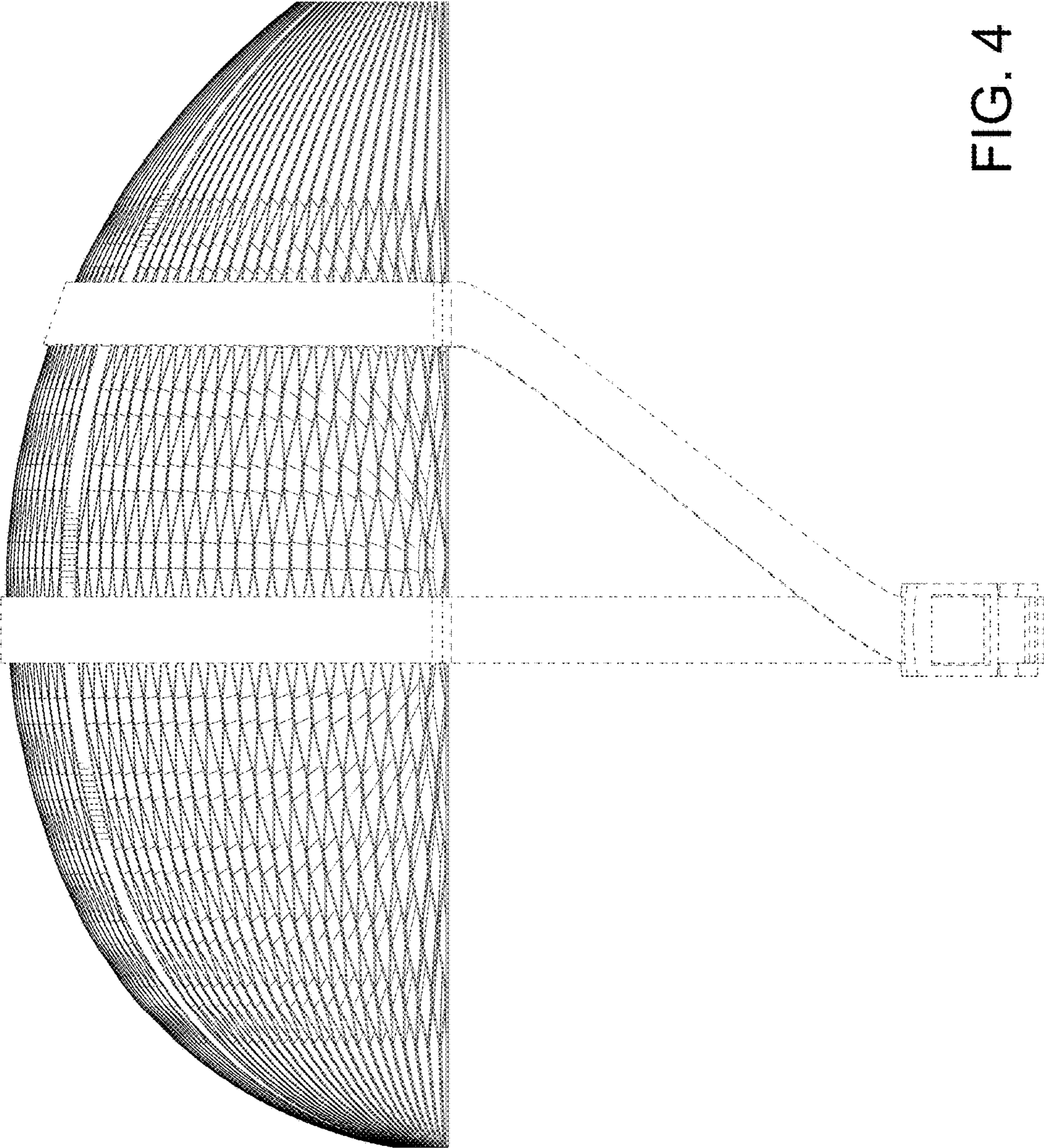

FIG. 4

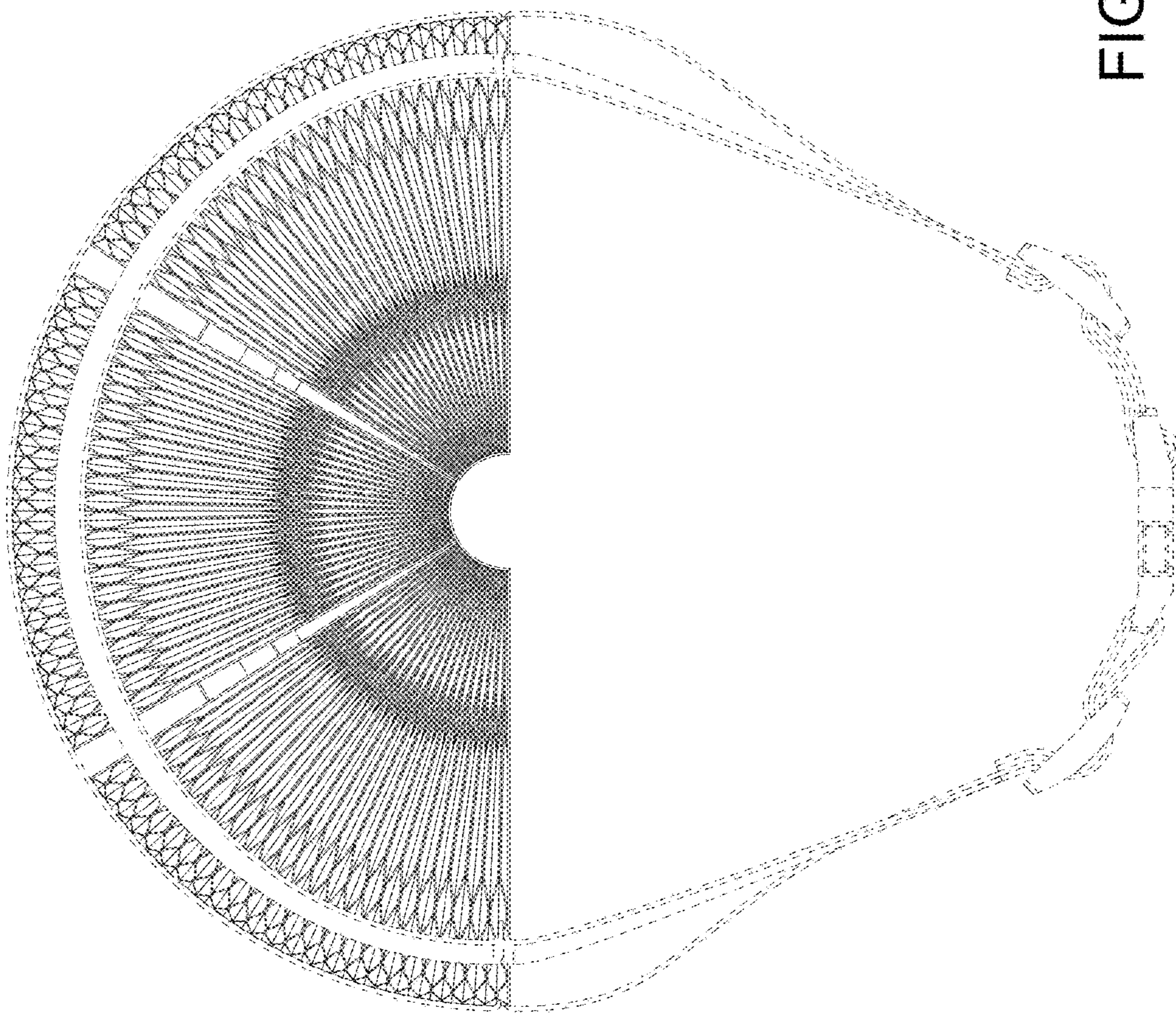

FIG. 5

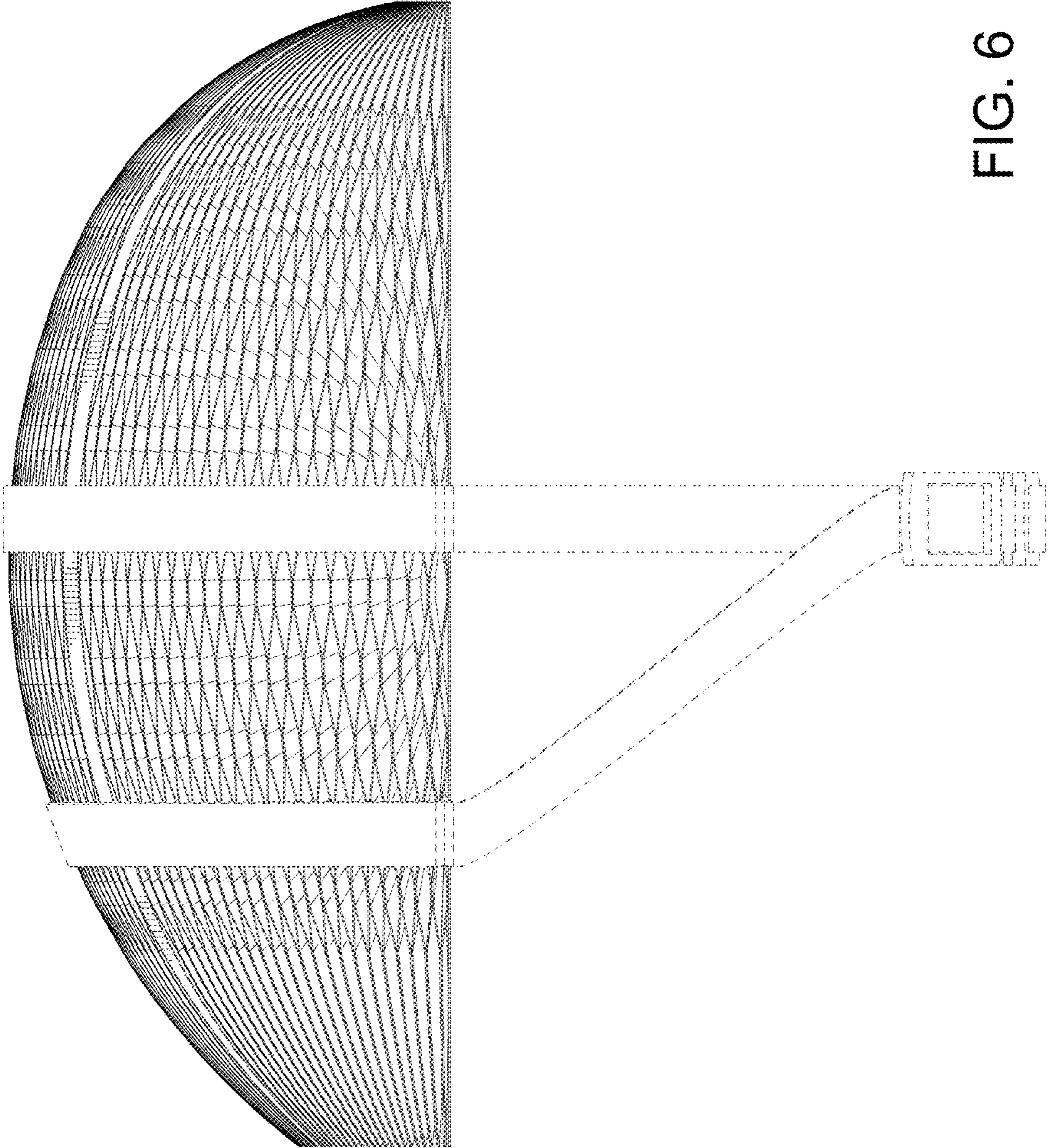

FIG. 6

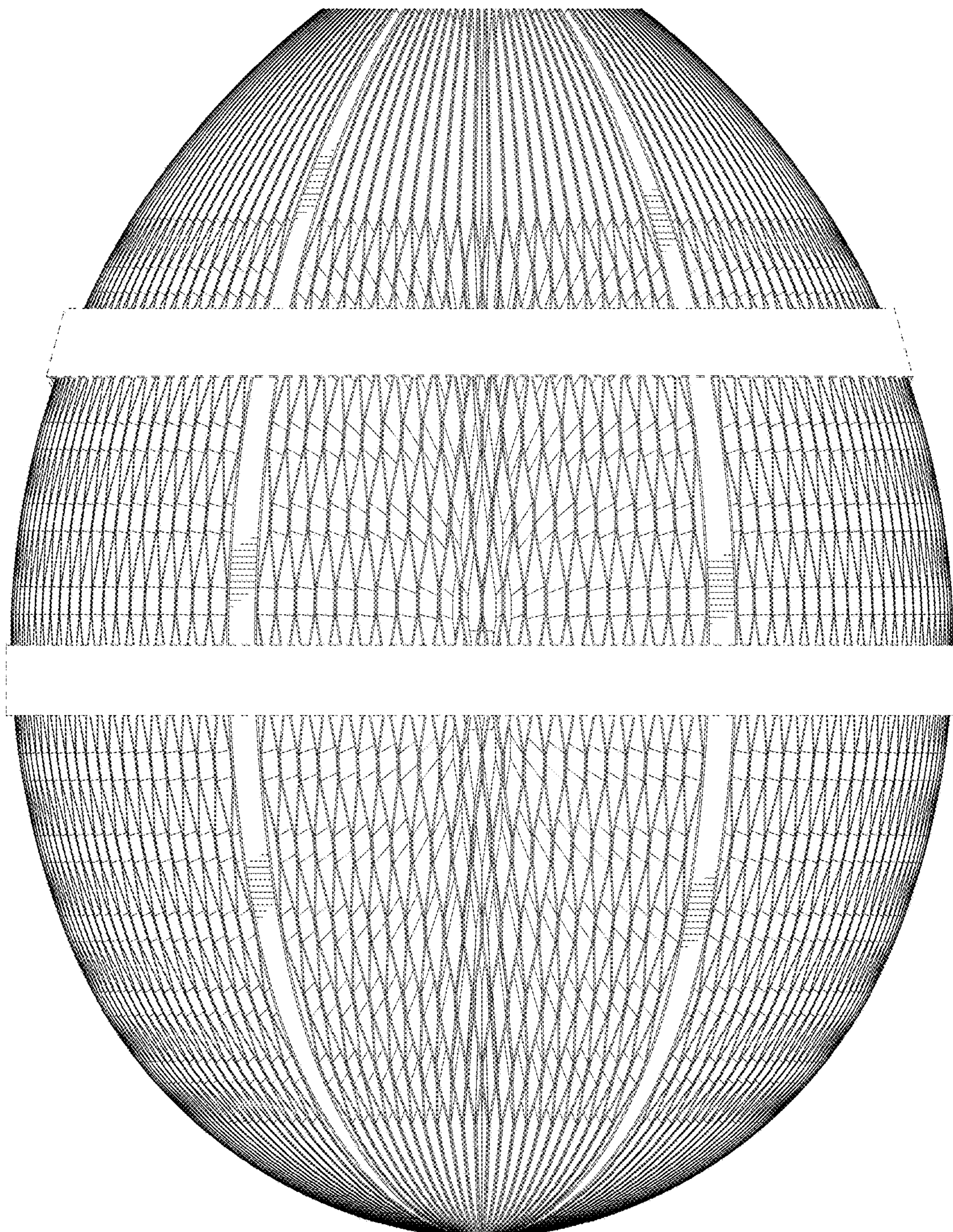

FIG. 7

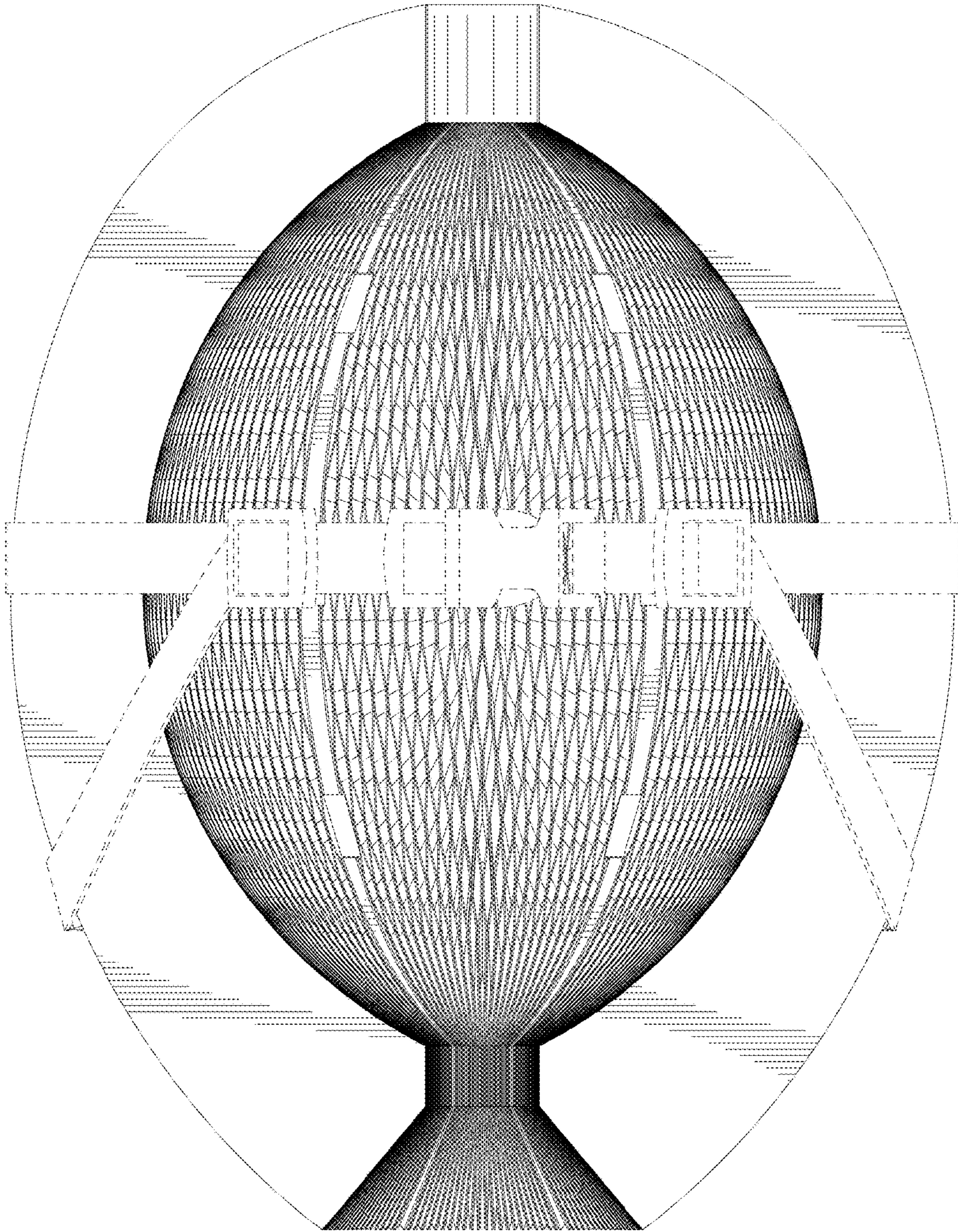

FIG. 8

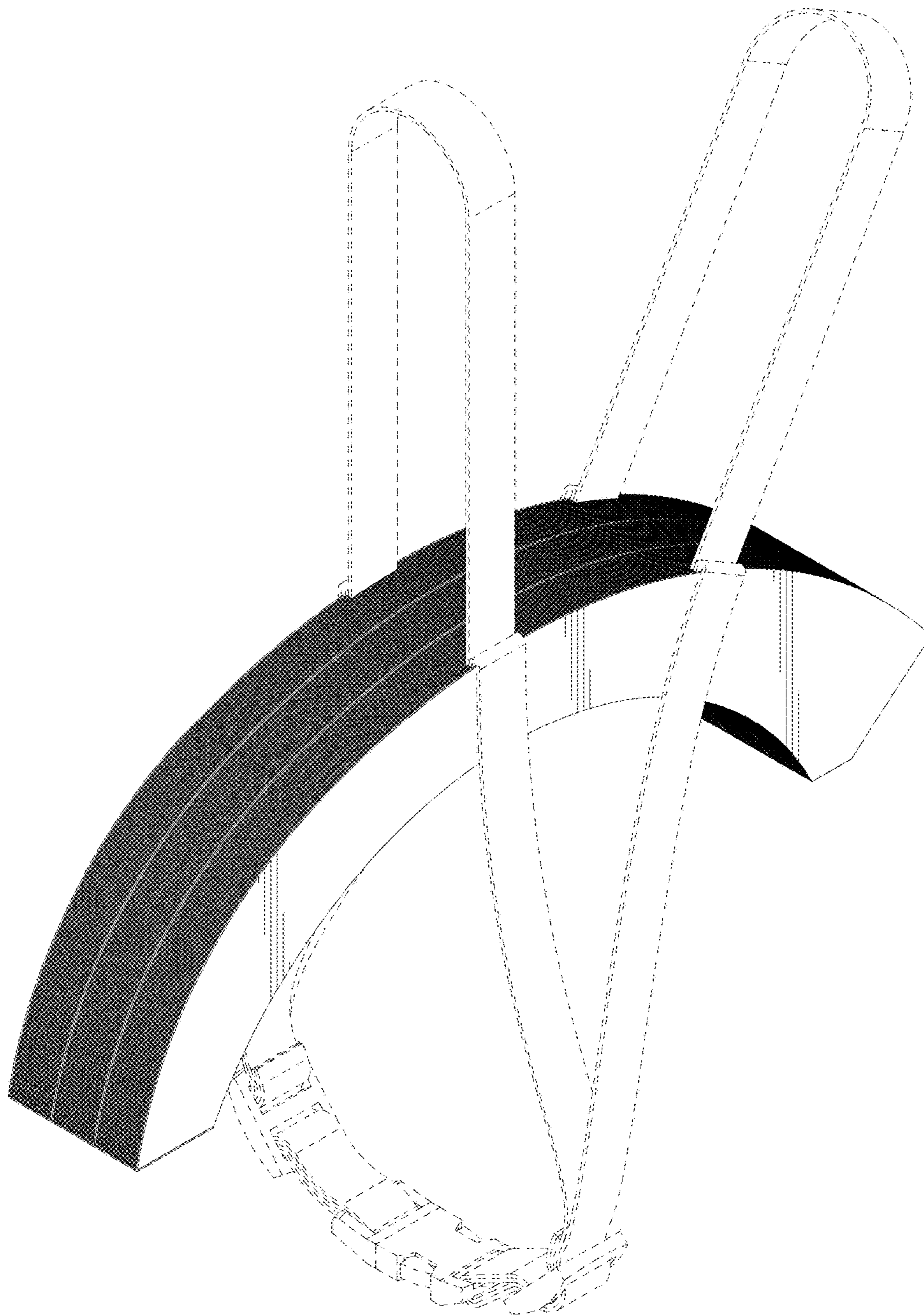

FIG. 9

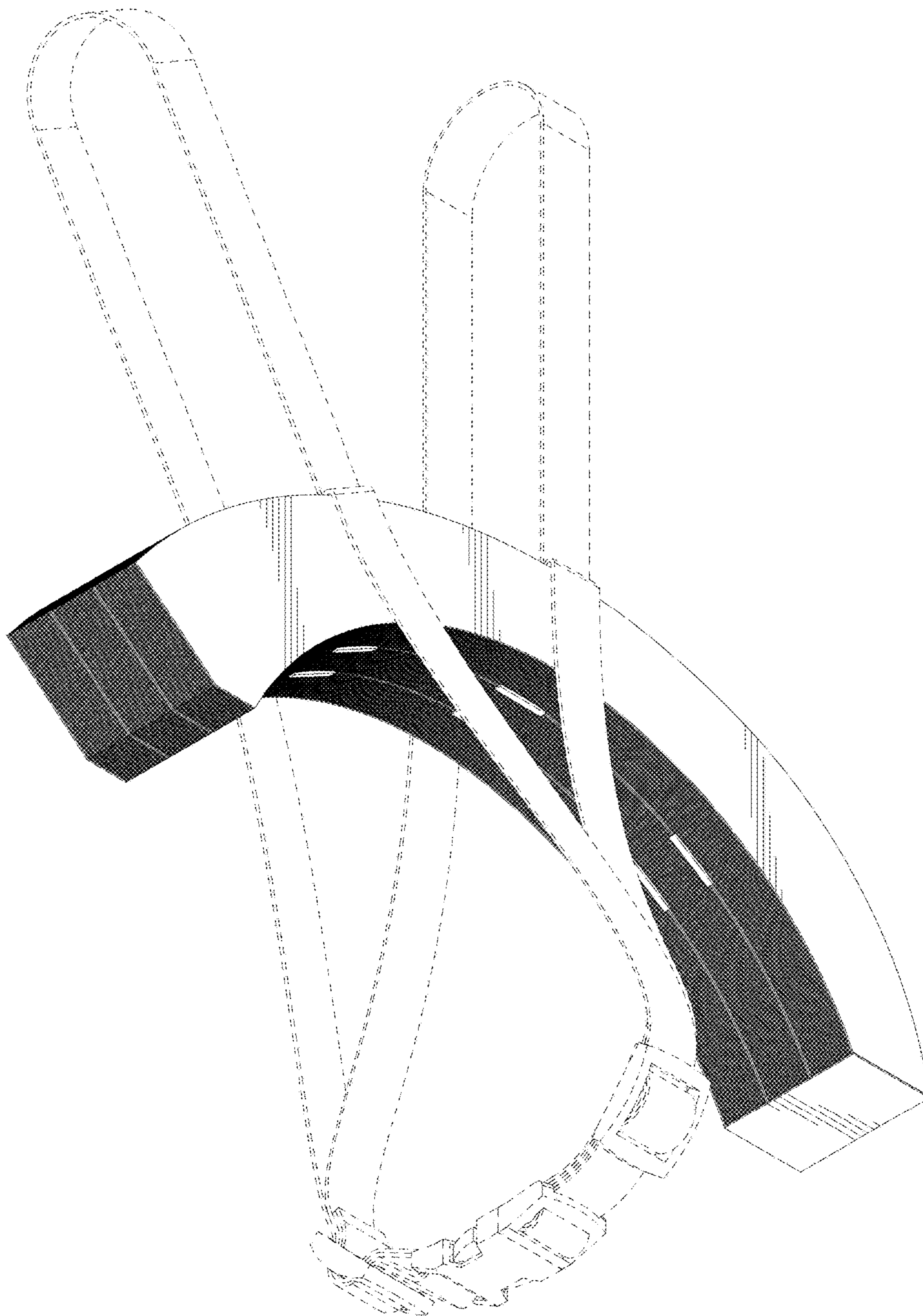

FIG. 10

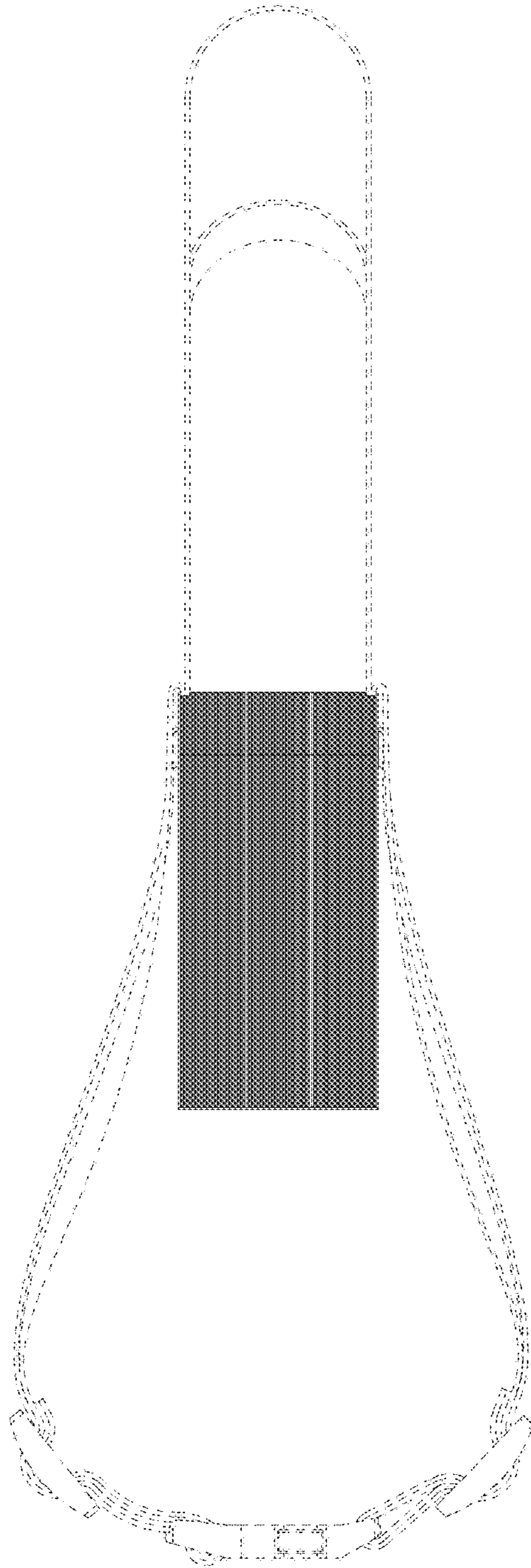

FIG. 11

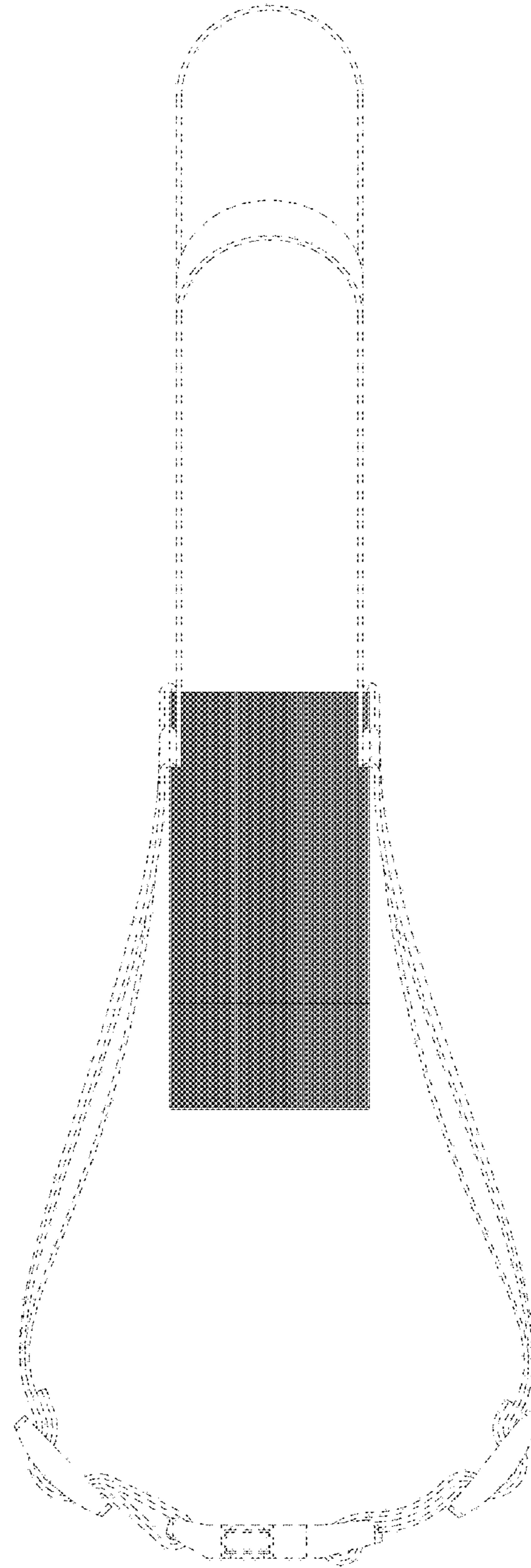

FIG. 12

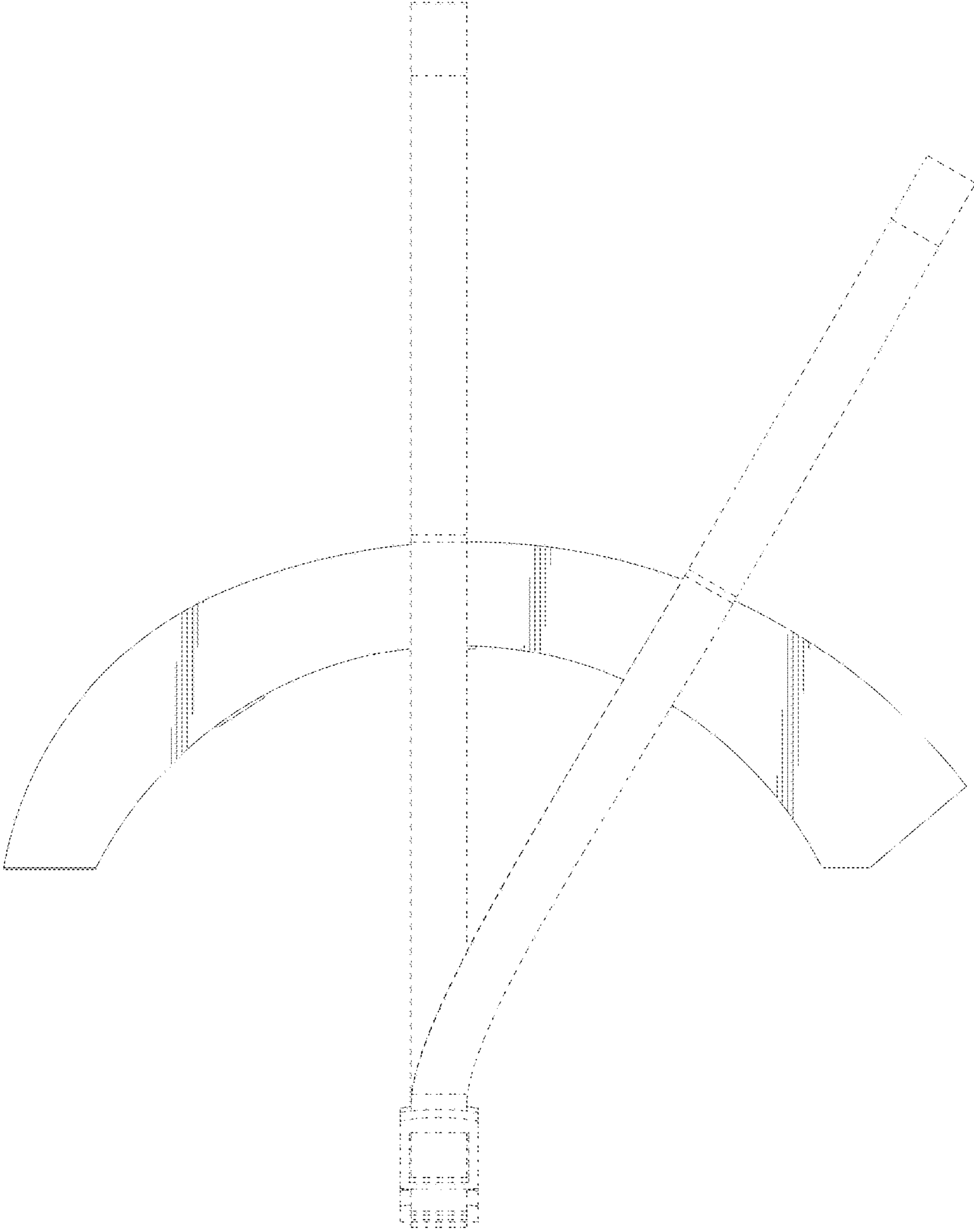

FIG. 13

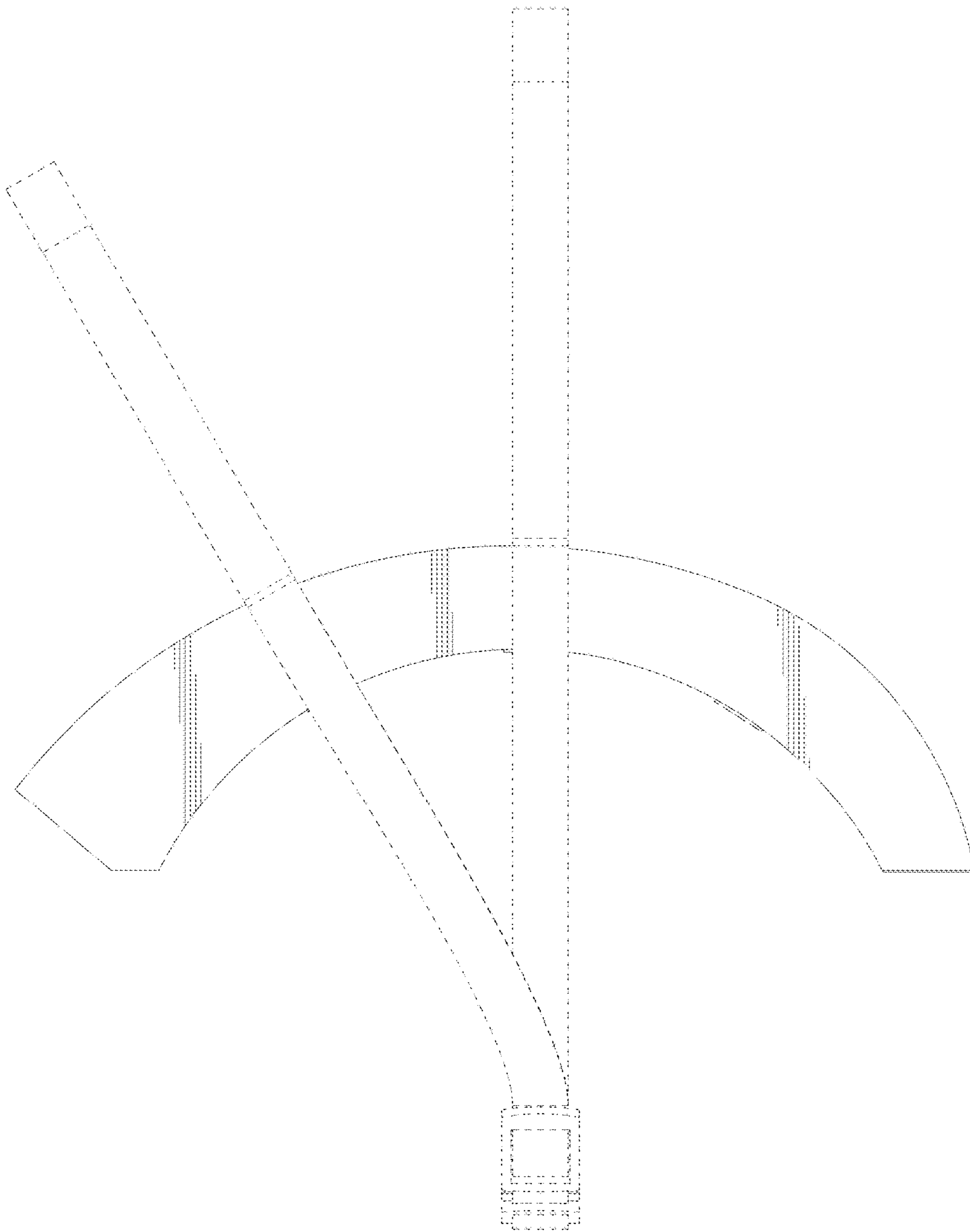

FIG. 14

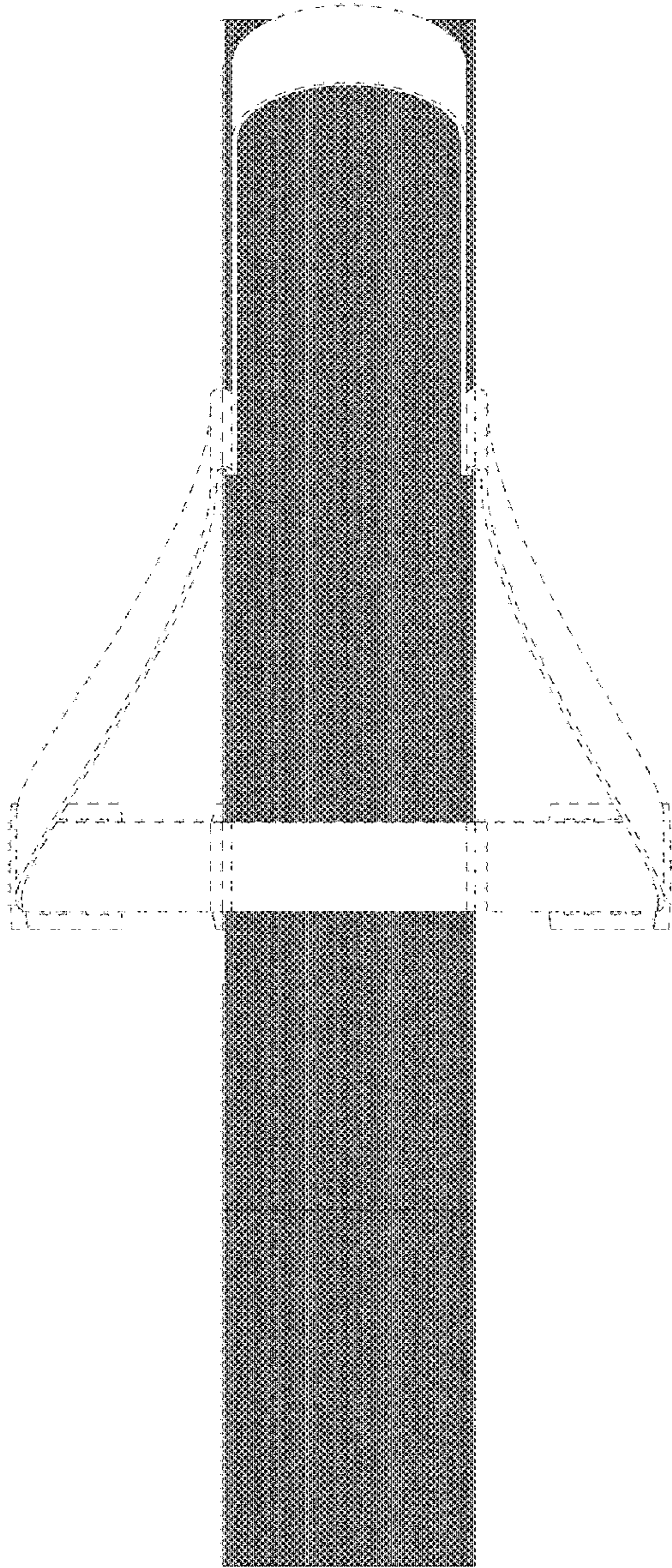

FIG. 15

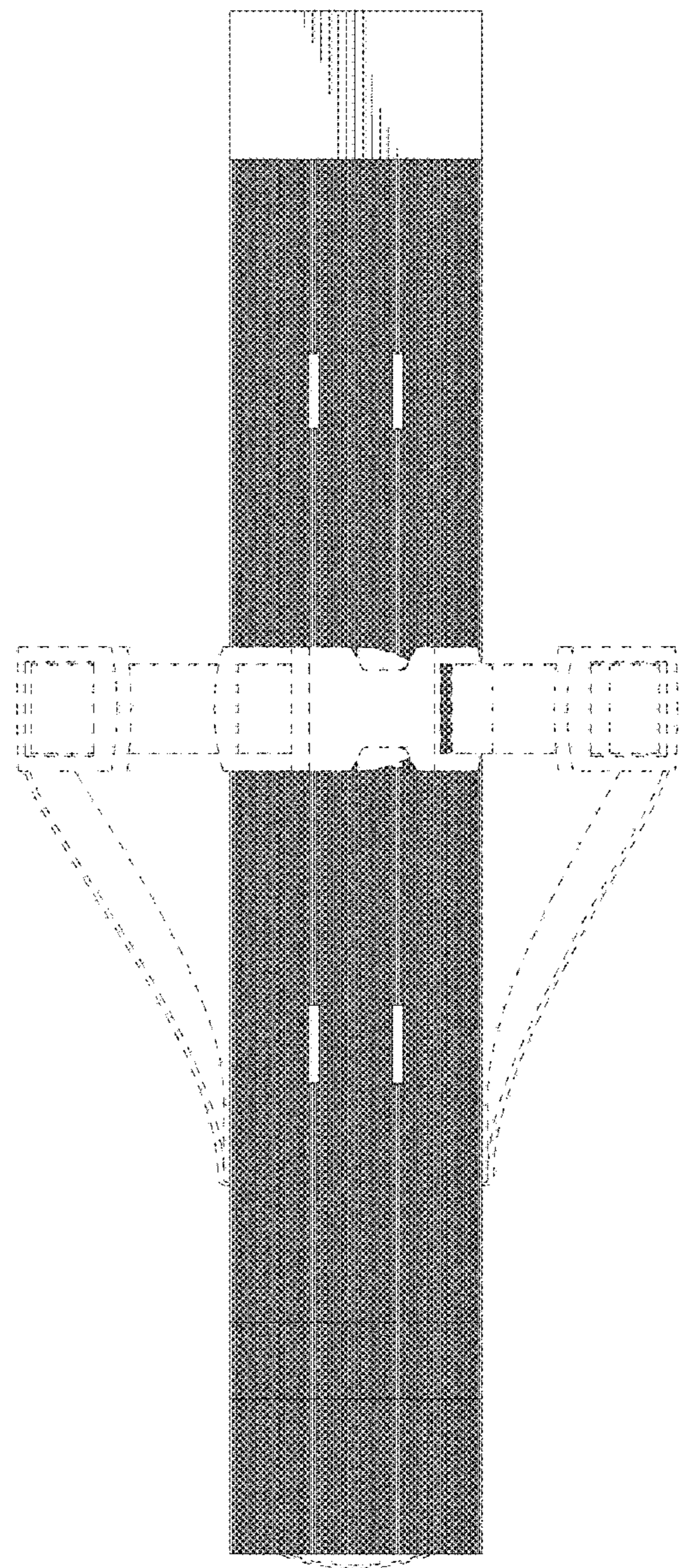

FIG. 16