



US00D836820S

(12) **United States Design Patent**
Sonneman

(10) **Patent No.:** **US D836,820 S**

(45) **Date of Patent:** **** *Dec. 25, 2018**

(54) **LIGHT FIXTURE**

(71) Applicant: **Contemporary Visions, LLC,**
Larchmont, NY (US)

(72) Inventor: **Robert A. Sonneman,** Mamaroneck,
NY (US)

(73) Assignee: **CONTEMPORARY VISIONS, LLC,**
Larchmont, NY (US)

(*) Notice: This patent is subject to a terminal disclaimer.

(**) Term: **15 Years**

(21) Appl. No.: **29/628,747**

(22) Filed: **Dec. 7, 2017**

(51) **LOC (11) Cl.** **26-03**

(52) **U.S. Cl.**
USPC **D26/86**

(58) **Field of Classification Search**
USPC D26/72, 80, 82, 83, 85, 86, 87, 92;
D8/300, 307, 315

CPC .. F21S 8/033; F21S 8/035; F21S 8/036; F21S
9/02

See application file for complete search history.

(56) **References Cited**

U.S. PATENT DOCUMENTS

D228,146 S * 8/1973 Schwartz D26/82
5,246,285 A * 9/1993 Redburn F21S 9/02
312/223.5

D487,814 S * 3/2004 Hoernig D26/82
D549,383 S * 8/2007 Duggan D26/85
D550,885 S * 9/2007 Crosby D26/75
D583,976 S * 12/2008 Horn D26/72
D697,661 S * 1/2014 Sabernig D26/80
D724,776 S * 3/2015 Sonneman D26/85
D796,294 S * 9/2017 Simon D8/315
D816,882 S * 5/2018 Qiao D26/86
D824,076 S * 7/2018 Sonneman D26/86

* cited by examiner

Primary Examiner — Brian N. Vinson

(74) *Attorney, Agent, or Firm* — Gottlieb, Rackman & Reisman, P.C.

(57) **CLAIM**

The ornamental design for a light fixture, as shown and described.

DESCRIPTION

FIG. 1 is a perspective view of a light fixture showing my new design;

FIG. 2 is a front elevational view thereof;

FIG. 3 is a rear elevational view thereof;

FIG. 4 is a left side elevational view thereof;

FIG. 5 is a right side elevational view thereof;

FIG. 6 is a top plan view thereof; and,

FIG. 7 is a bottom plan view thereof.

The broken lines shown in the drawings are included for the purpose of illustrating portions of the light fixture, which is surface mountable, that form no part of the claimed design.

1 Claim, 4 Drawing Sheets

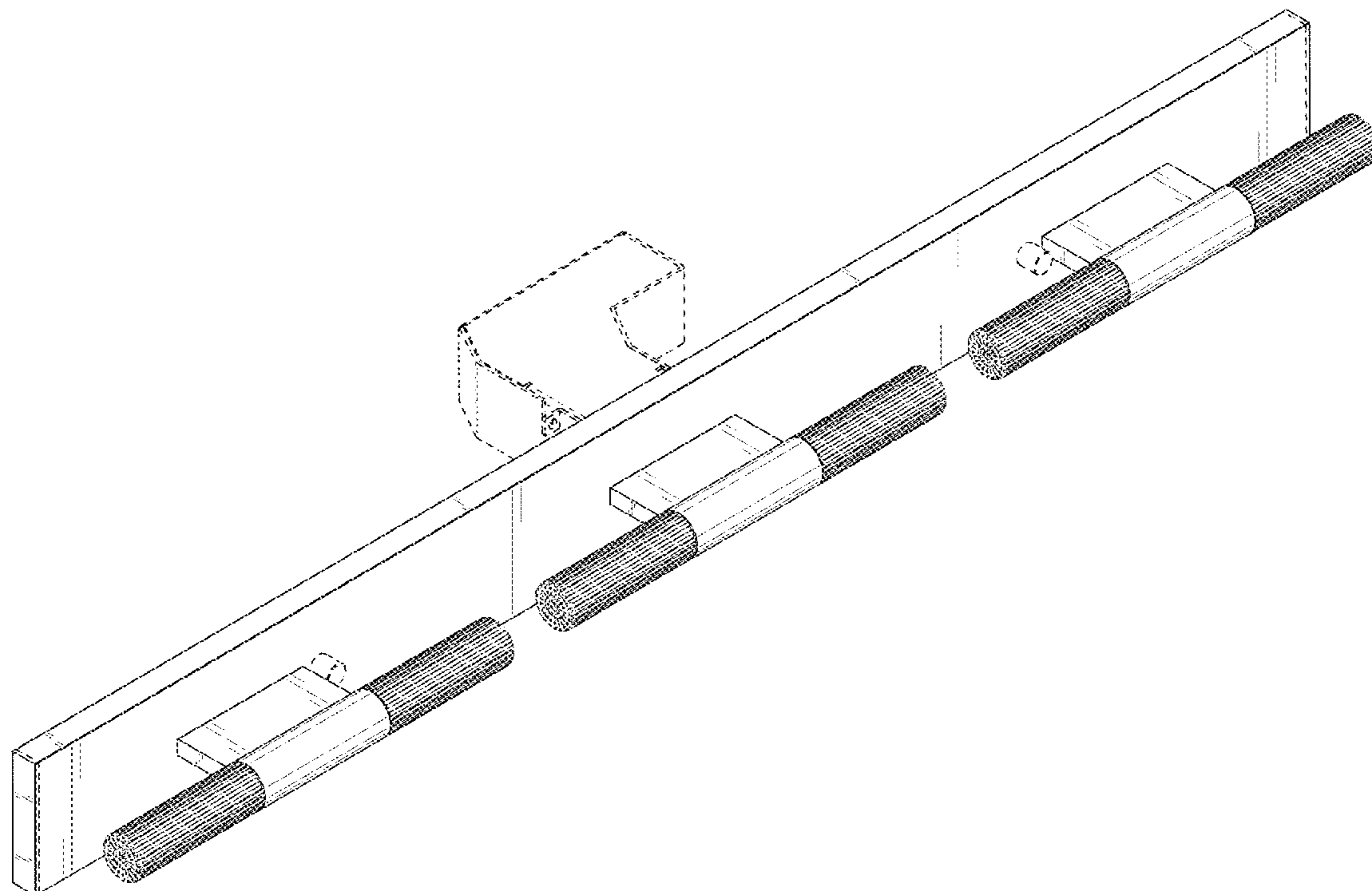

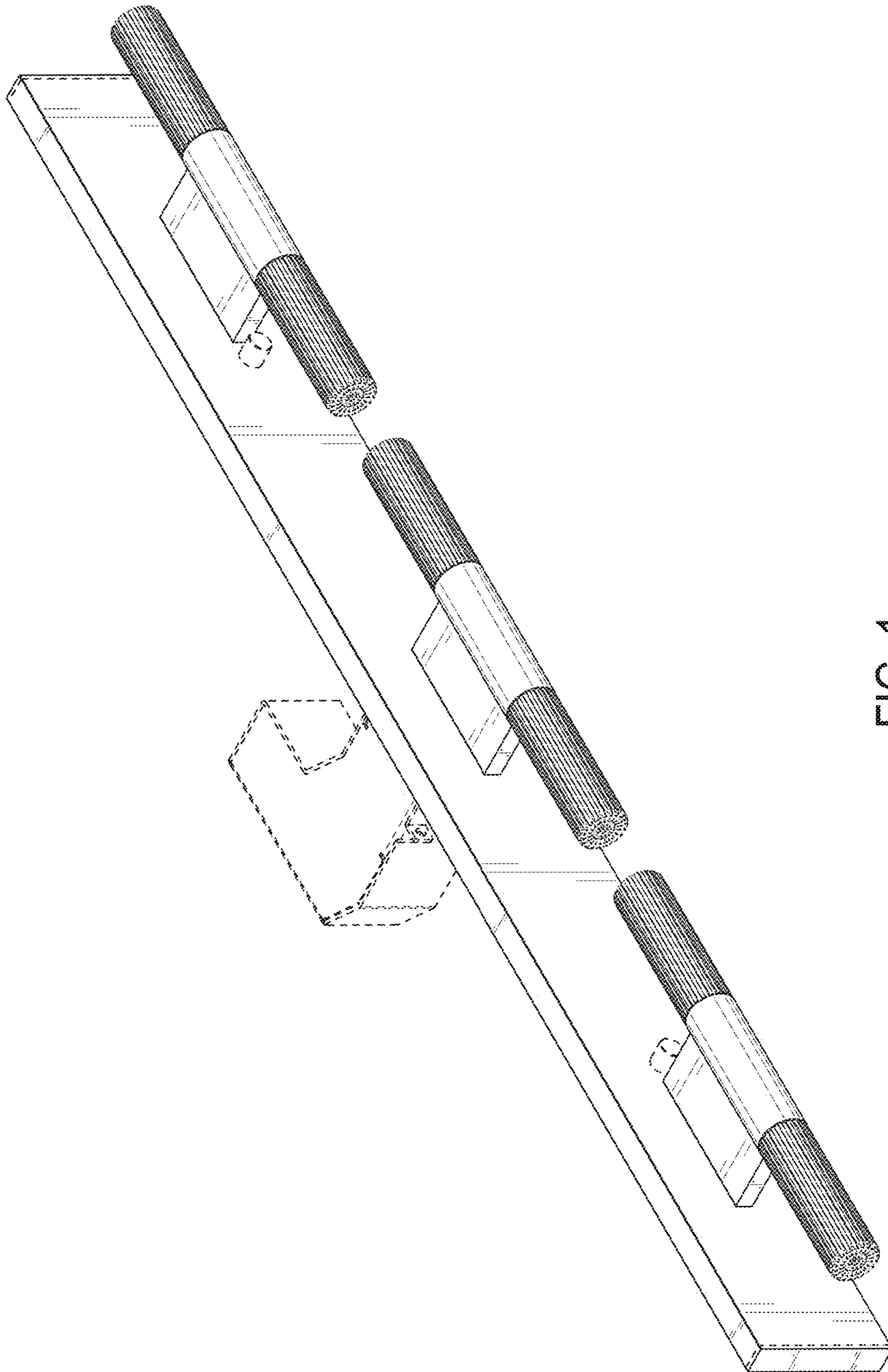

FIG. 1

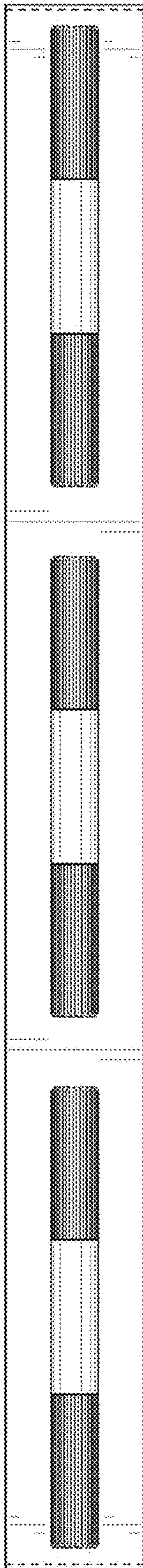

FIG. 2

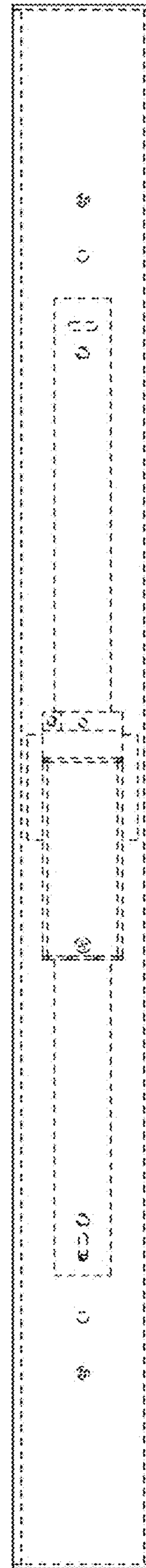

FIG. 3

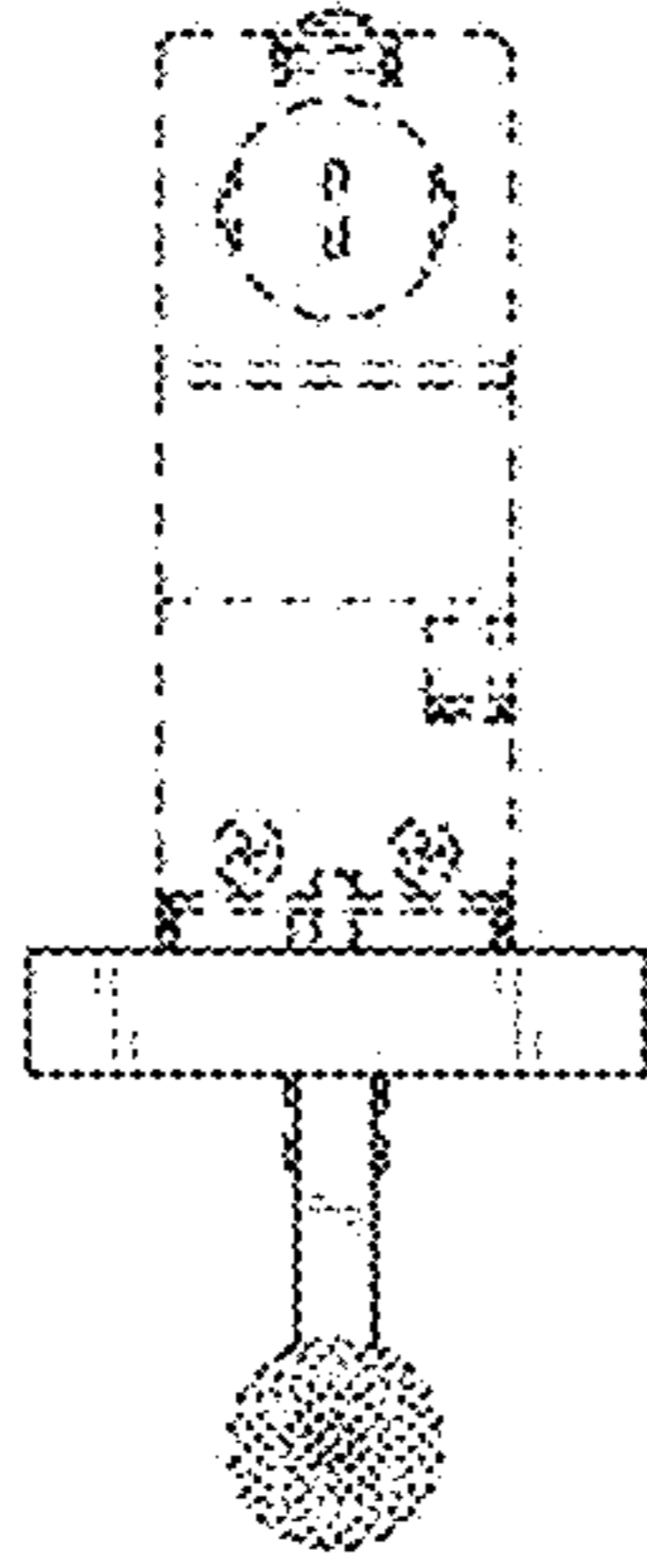

FIG. 5

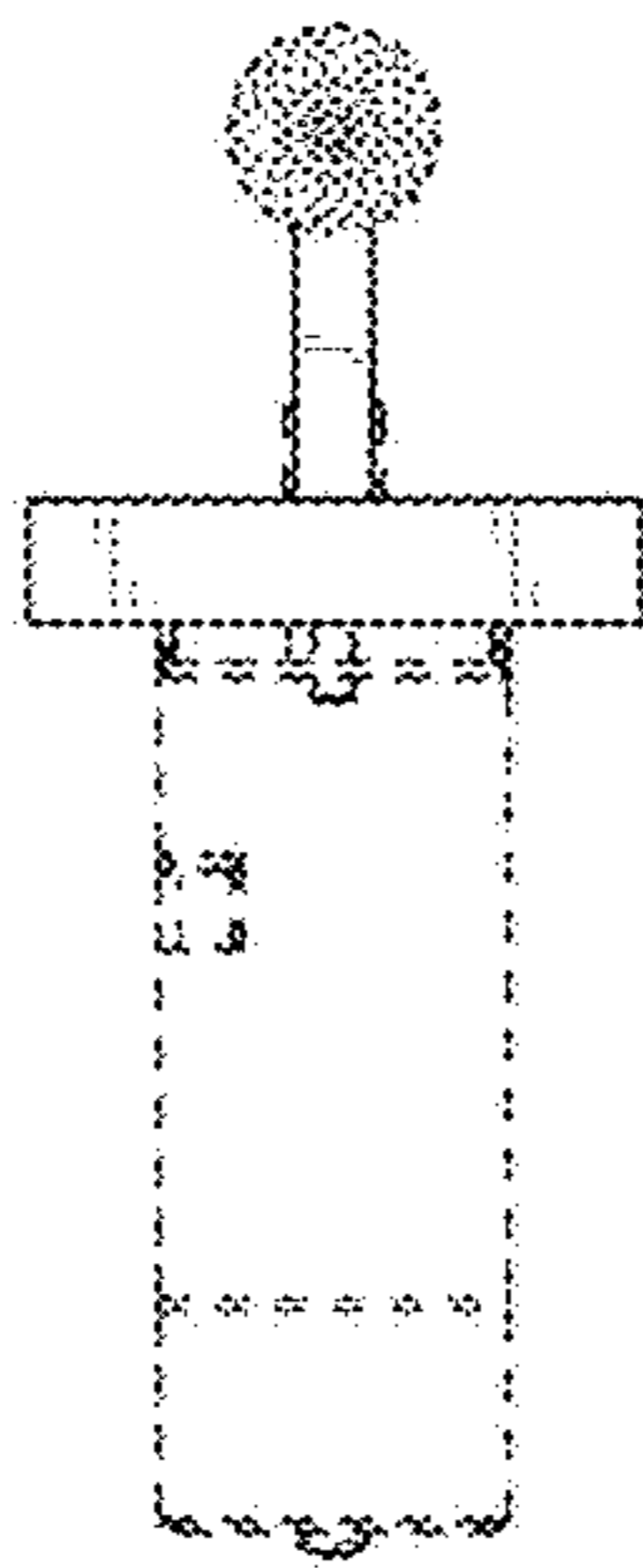

FIG. 4

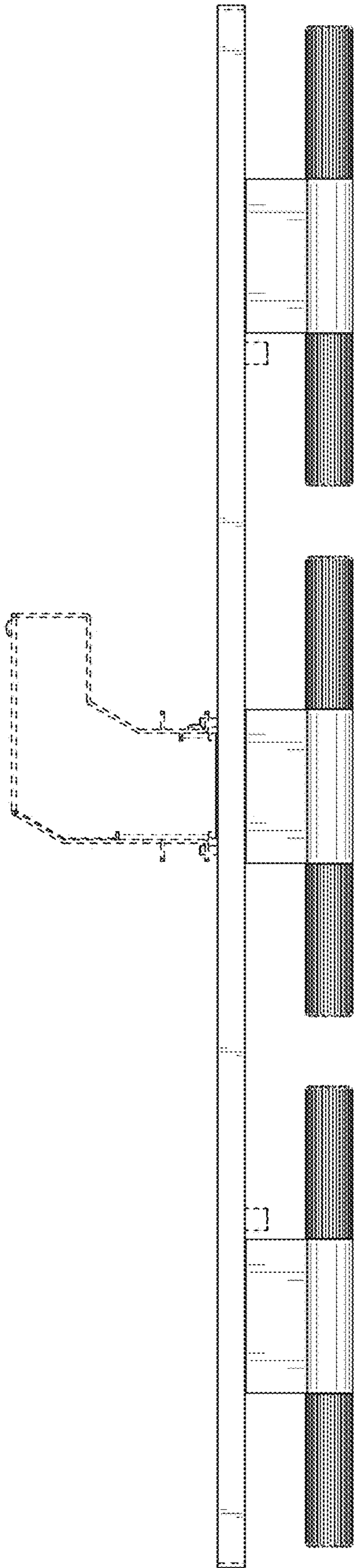

FIG. 6

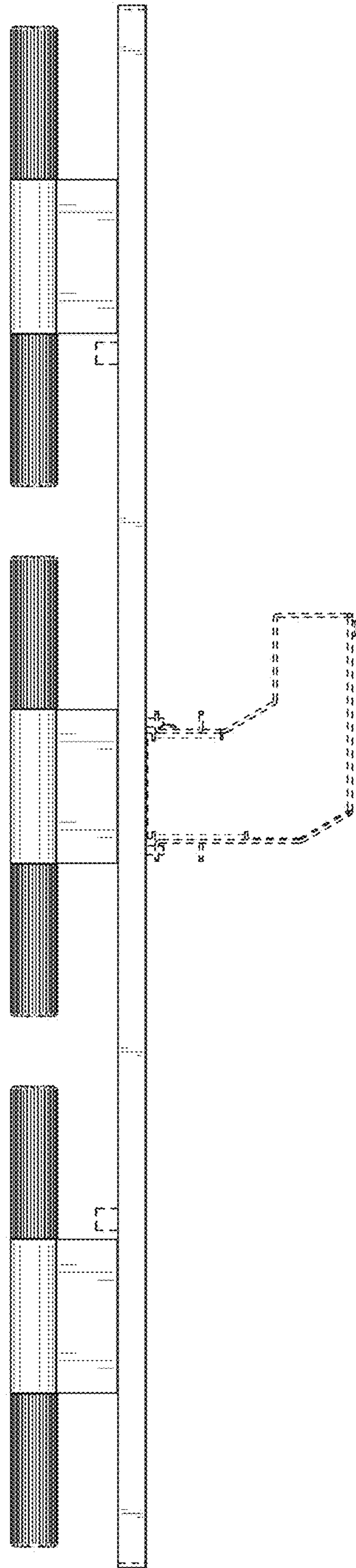

FIG. 7