



US00D836784S

(12) **United States Design Patent** (10) **Patent No.:** **US D836,784 S**  
**Okamoto** (45) **Date of Patent:** **\*\* Dec. 25, 2018**

- (54) **SACRUM PRESSING TOOL**
- (71) Applicant: **Q O L CO., LTD.**, Osaka (JP)
- (72) Inventor: **Koichi Okamoto**, Osaka (JP)
- (73) Assignee: **Q O L Co., Ltd.**, Osaka (JP)
- (\*\*) Term: **15 Years**
- (21) Appl. No.: **35/503,997**
- (22) Filed: **Oct. 31, 2017**
- (80) **Hague Agreement Data**

Int. Filing Date: **Oct. 31, 2017**  
 Int. Reg. No.: **DM/098404**  
 Int. Reg. Date: **Oct. 31, 2017**  
 Int. Reg. Pub. Date: **Nov. 24, 2017**

- (51) **LOC (11) Cl.** ..... **24-04**
- (52) **U.S. Cl.**  
USPC ..... **D24/190**
- (58) **Field of Classification Search**  
USPC ..... D24/133, 128, 190  
CPC ..... Y10S 128/23; A61F 5/028; A61F 5/02;  
A61F 5/022; A61F 5/055  
See application file for complete search history.

(56) **References Cited**

**U.S. PATENT DOCUMENTS**

D438,624 S *	3/2001	Reina	.....	D24/190
D492,787 S *	7/2004	Weaver, II	.....	D24/190
D518,895 S *	4/2006	Weaver, II	.....	D24/190
D725,786 S *	3/2015	Romo	.....	D24/190
D750,232 S *	2/2016	Appelbaum	.....	D24/128
D750,233 S *	2/2016	Appelbaum	.....	D24/128
D750,234 S *	2/2016	Appelbaum	.....	D24/128
D784,544 S *	4/2017	Dudkiewicz	.....	D24/190
D816,234 S *	4/2018	Calvello	.....	D24/190

**FOREIGN PATENT DOCUMENTS**

JP 1564745 S 12/2016

\* cited by examiner

*Primary Examiner* — Michael A. Pratt  
*(74) Attorney, Agent, or Firm* — Dilworth & Barrese, LLP

(57) **CLAIM**

The ornamental design for a sacrum pressing tool, as shown and described.

**DESCRIPTION**

1.-2. Sacrum pressing tools

- 1.1 : Front
- 1.2 : Left
- 1.3 : Top
- 1.4 : Bottom
- 1.5 : Perspective
- 1.6 : Cross-sectional
- 1.7 : Reference view
- 2.1 : Front
- 2.2 : Left
- 2.3 : Top
- 2.4 : Bottom
- 2.5 : Perspective
- 2.6 : Cross-sectional
- 2.7 : Reference view

1.1: front view; 1.2: left side view; 1.3: top view; 1.4: bottom view; 1.5: perspective view; 1.6: cross-sectional view cut vertically at the center of the front view; 1.7: reference view thereof showing a condition in use; 2.1: front view; 2.2: left side view; 2.3: top view; 2.4: bottom view; 2.5: perspective view; 2.6: cross-sectional view cut vertically at the center of the front view; 2.7: reference view thereof showing a condition in use; the articles to the present designs relate to sacrum pressing tools for improving a motor function and reducing a burden on human body such as backache, by pressing and stabilizing sacrum; it is used by attaching things like tights and support belt; the broken lines in the reproductions show unclaimed environment only and form no part of the claimed designs; rear and right side views are omitted because they are identical to the front or right side views.

**1 Claim, 14 Drawing Sheets**

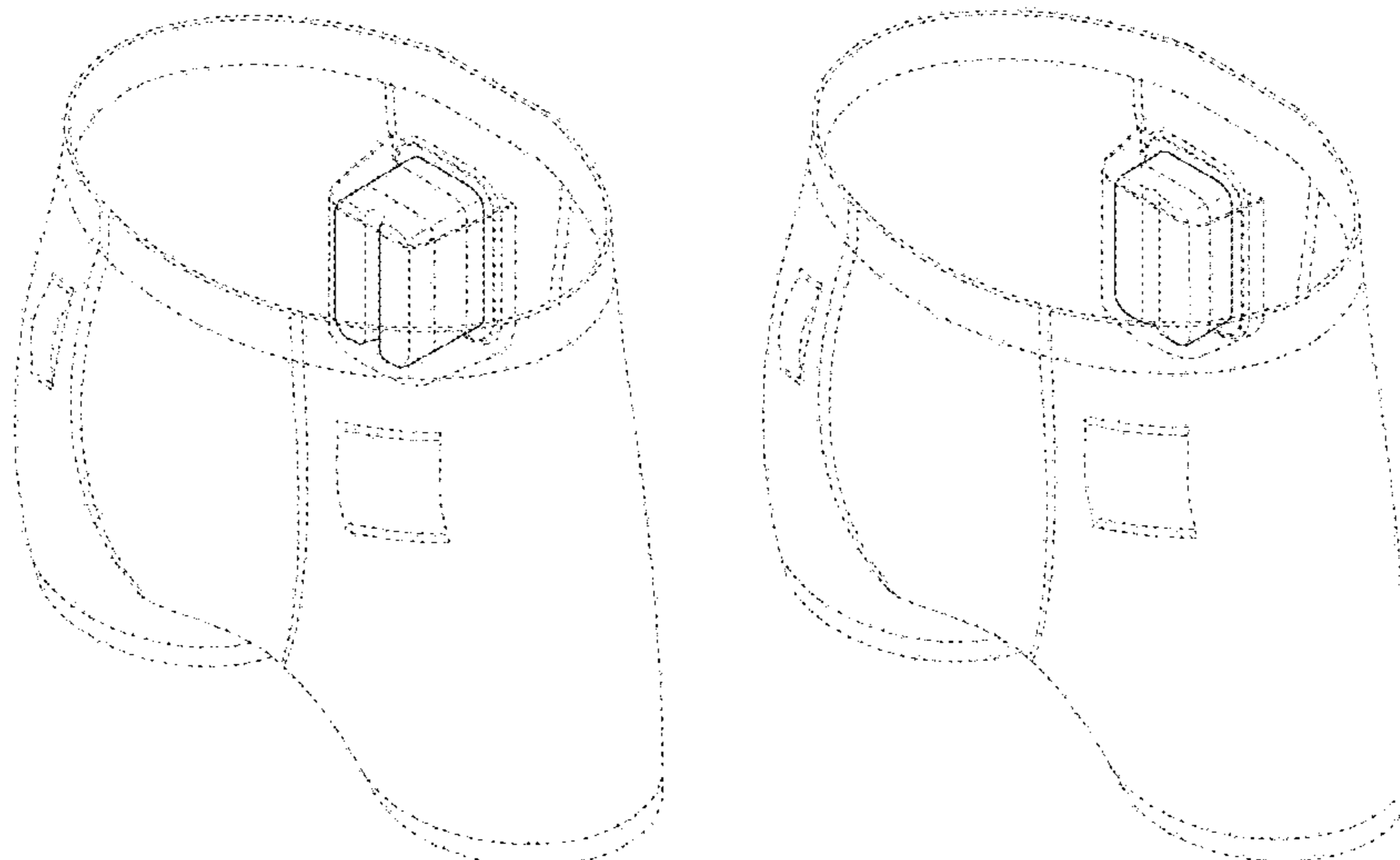

1.1

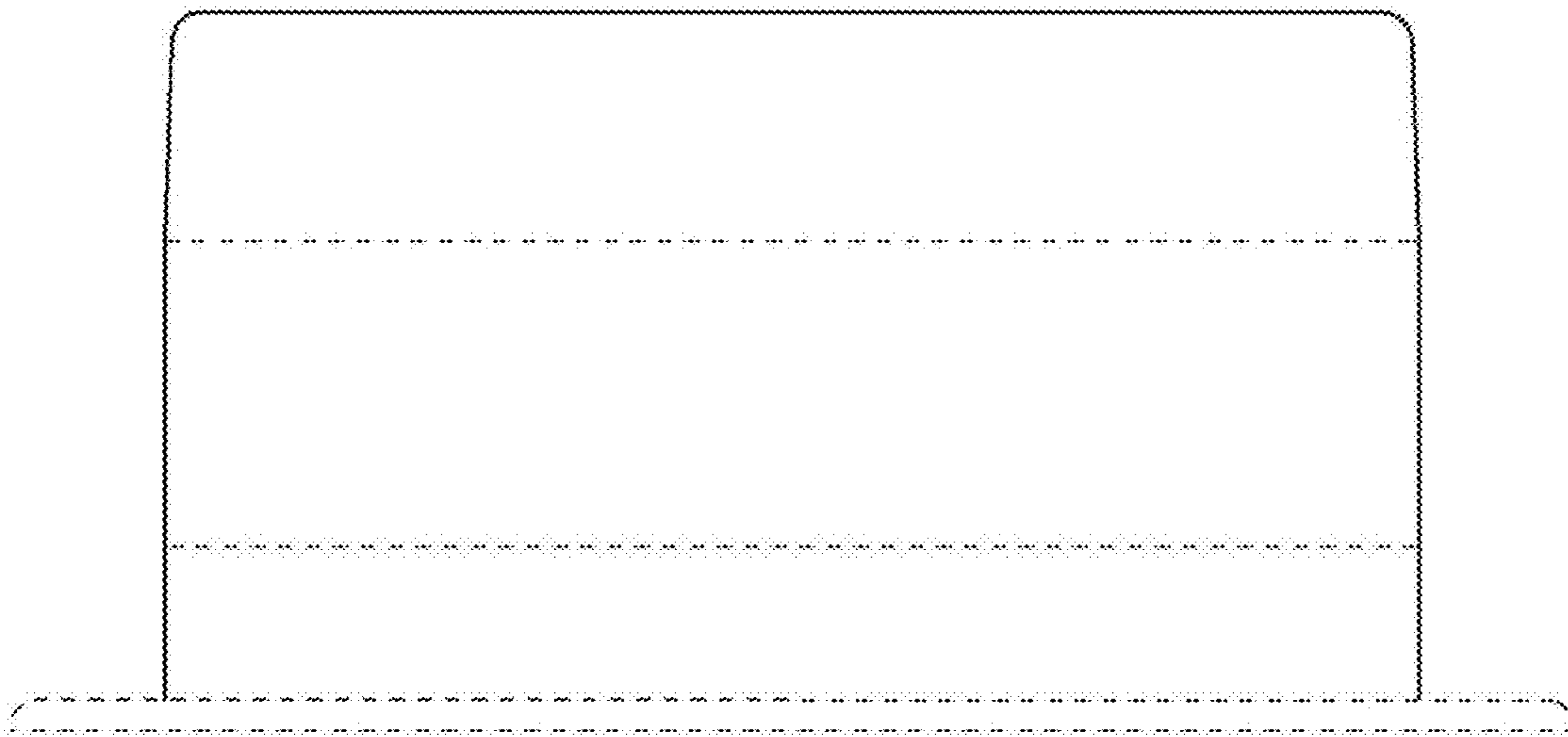

1.2

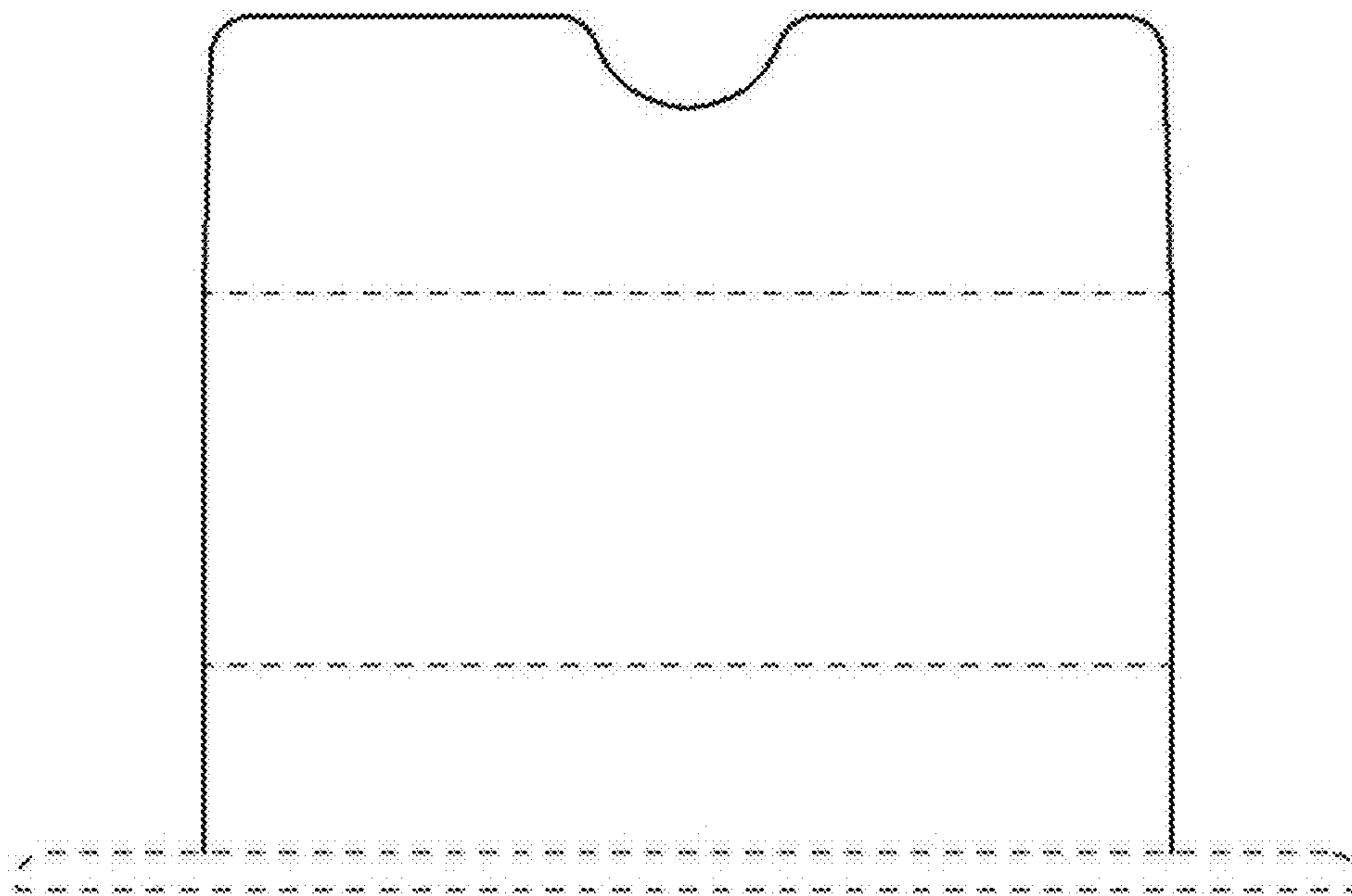

1.3

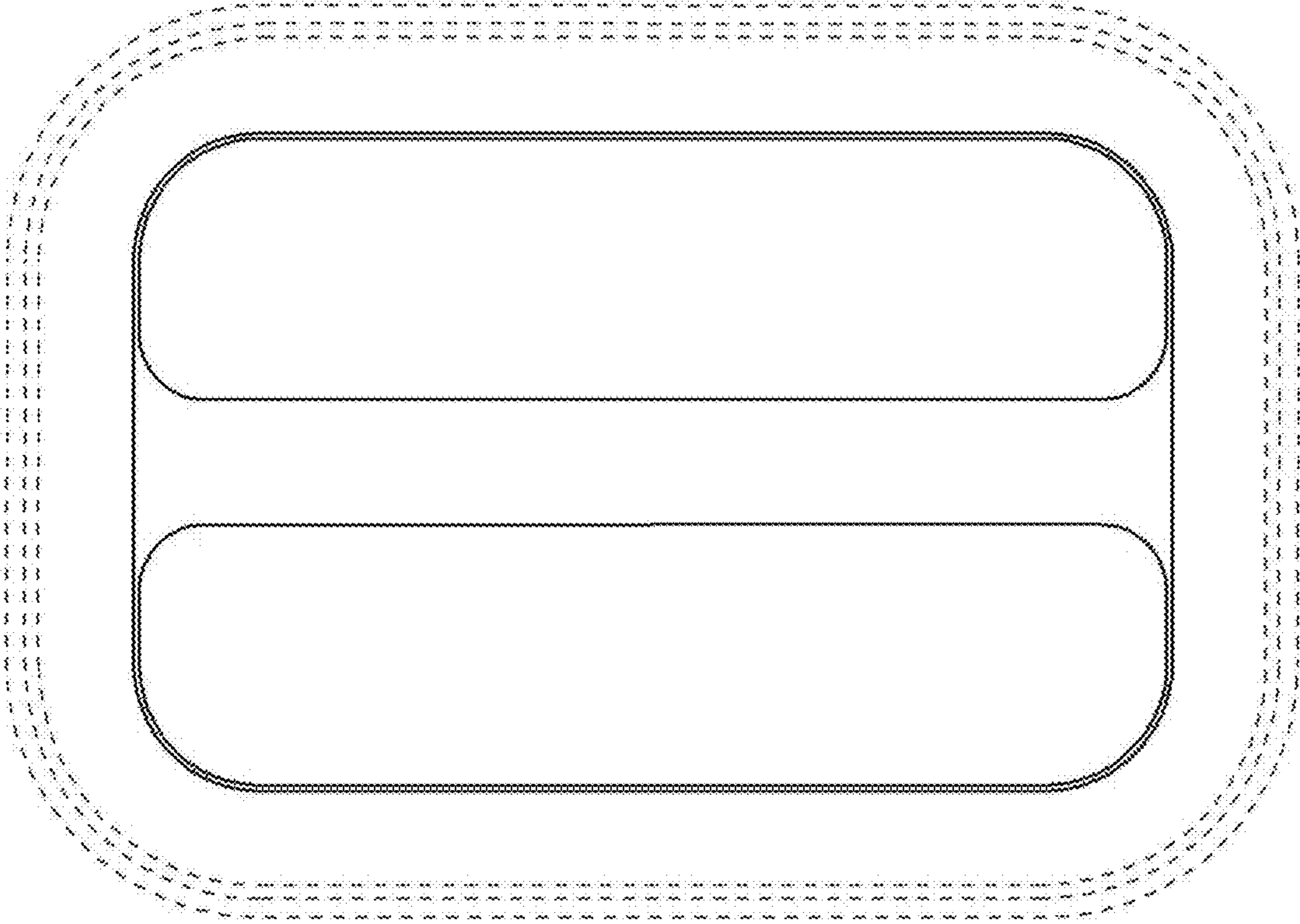

1.4

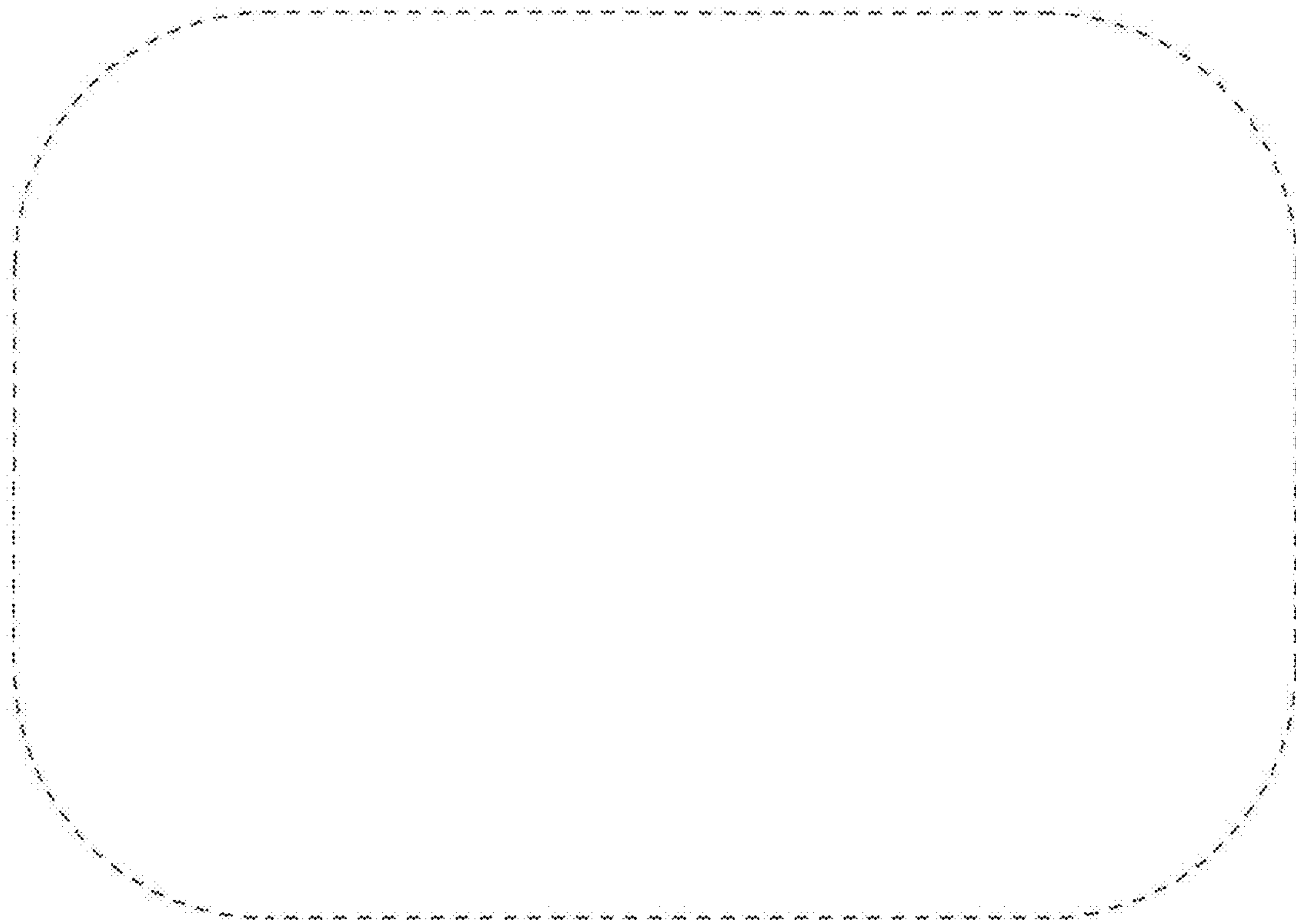

1.5

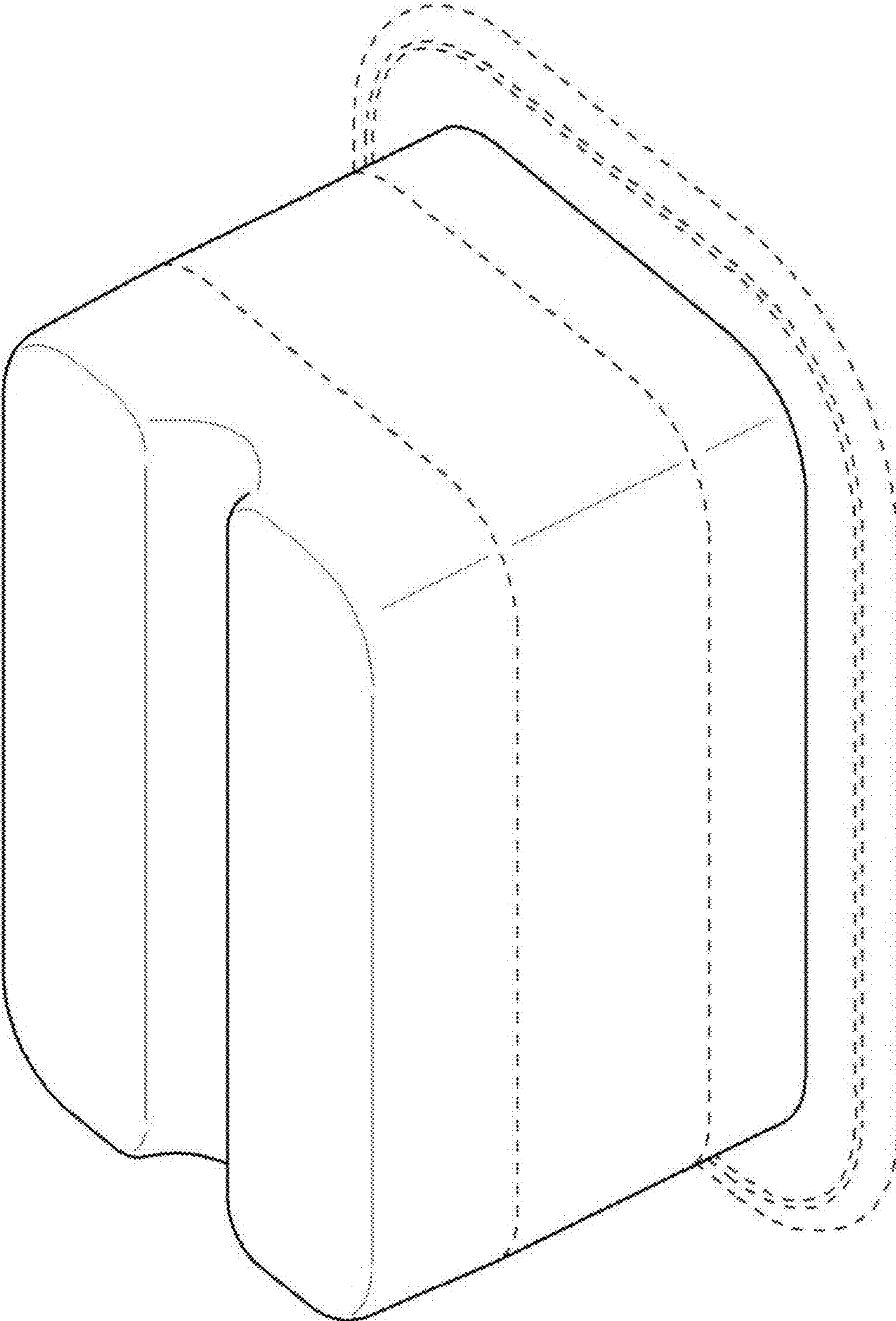

1.6

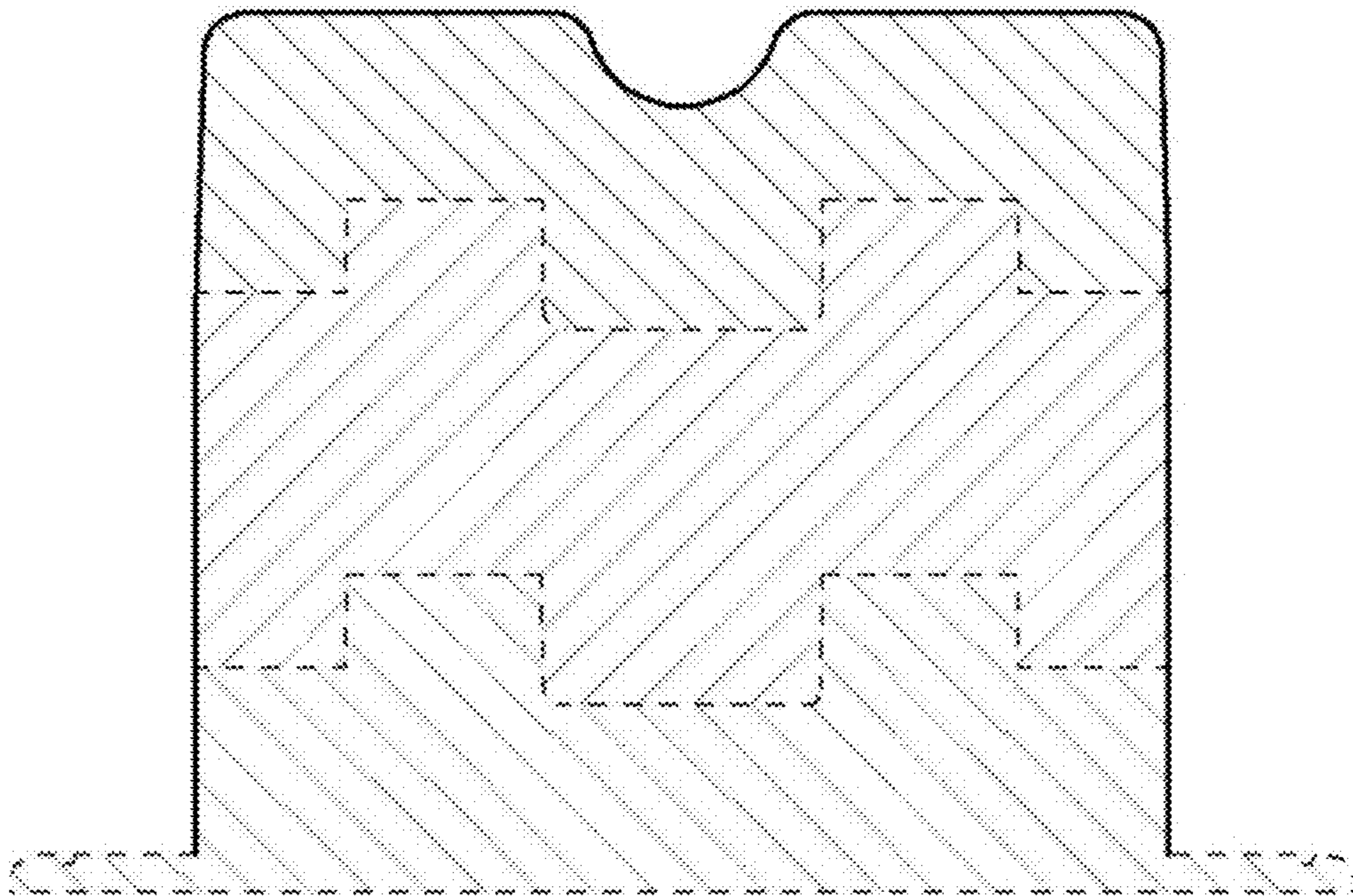

1.7

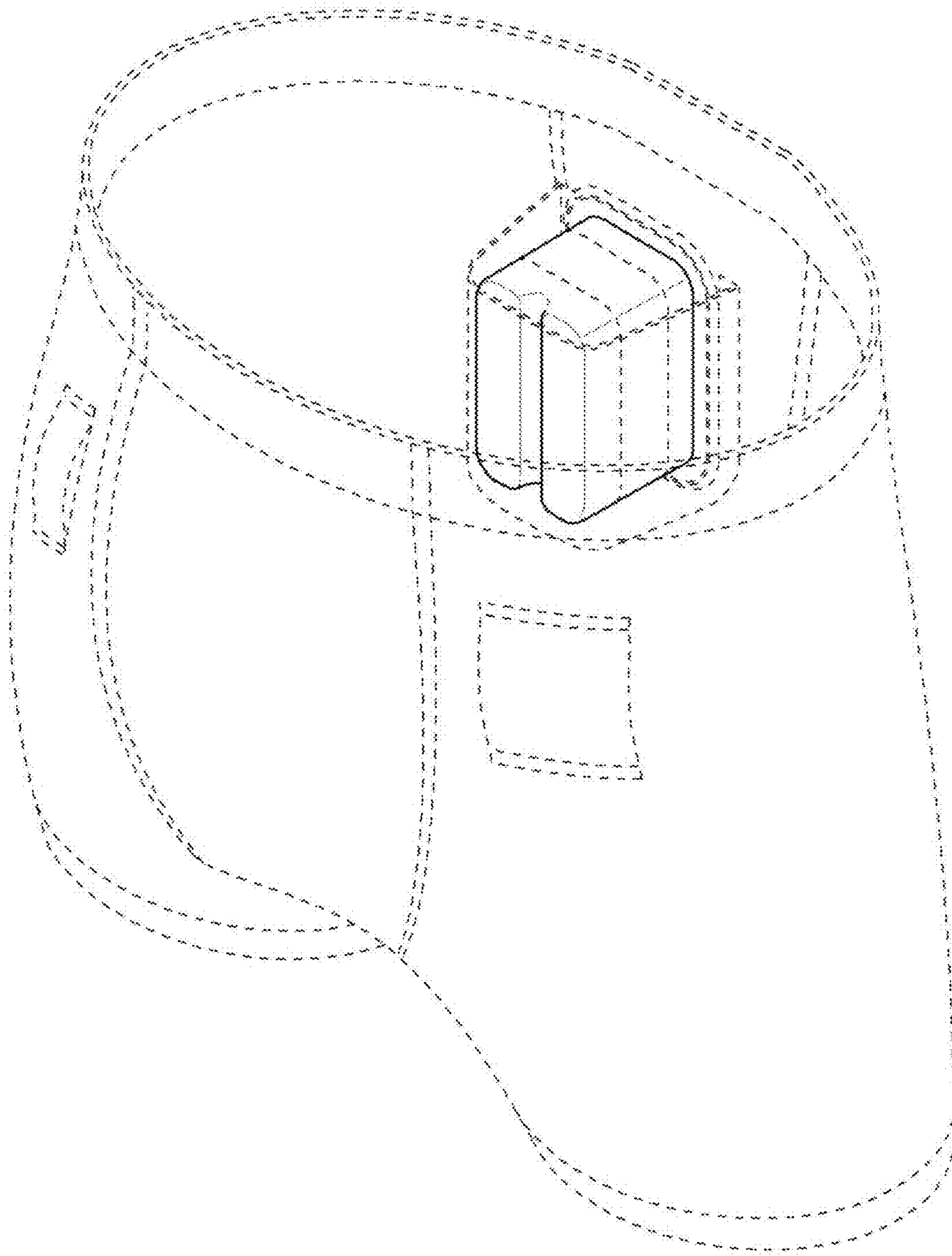



2.1

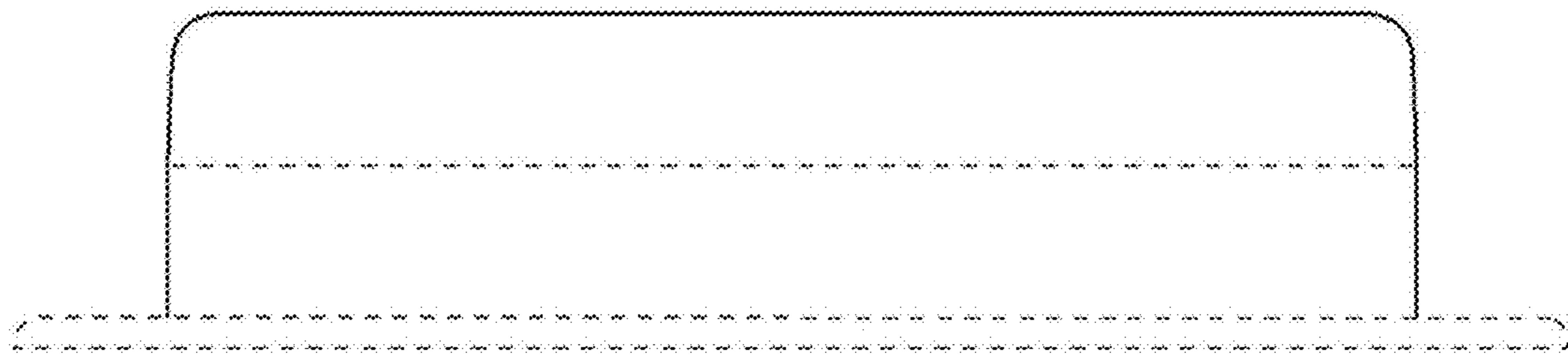

2.2

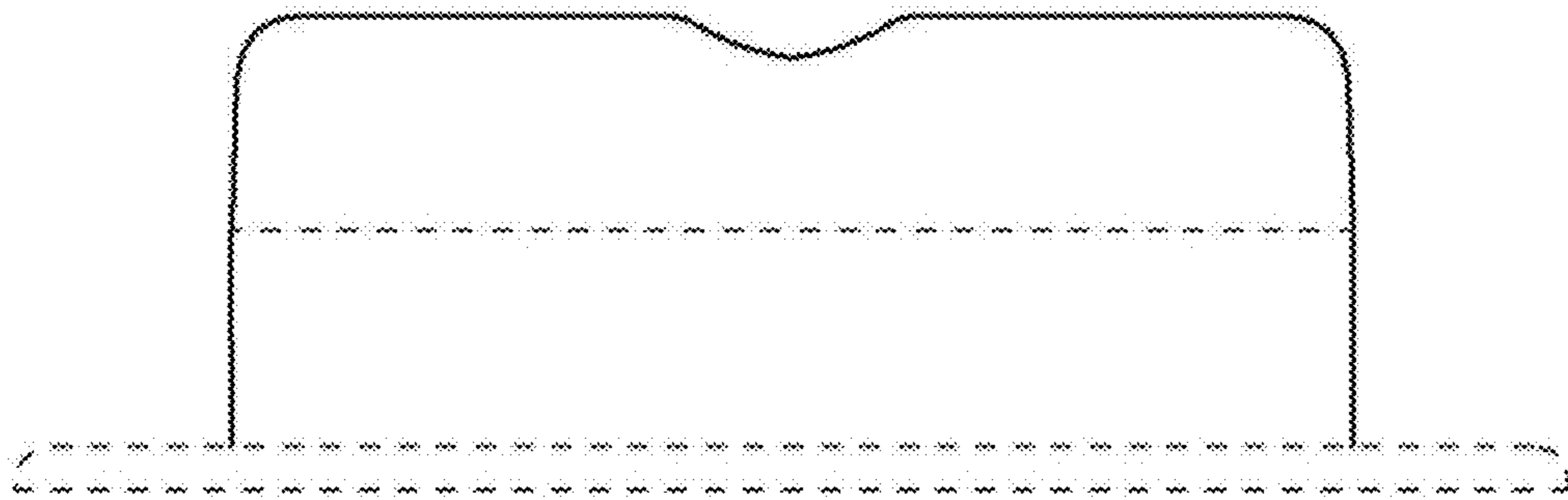

2.3

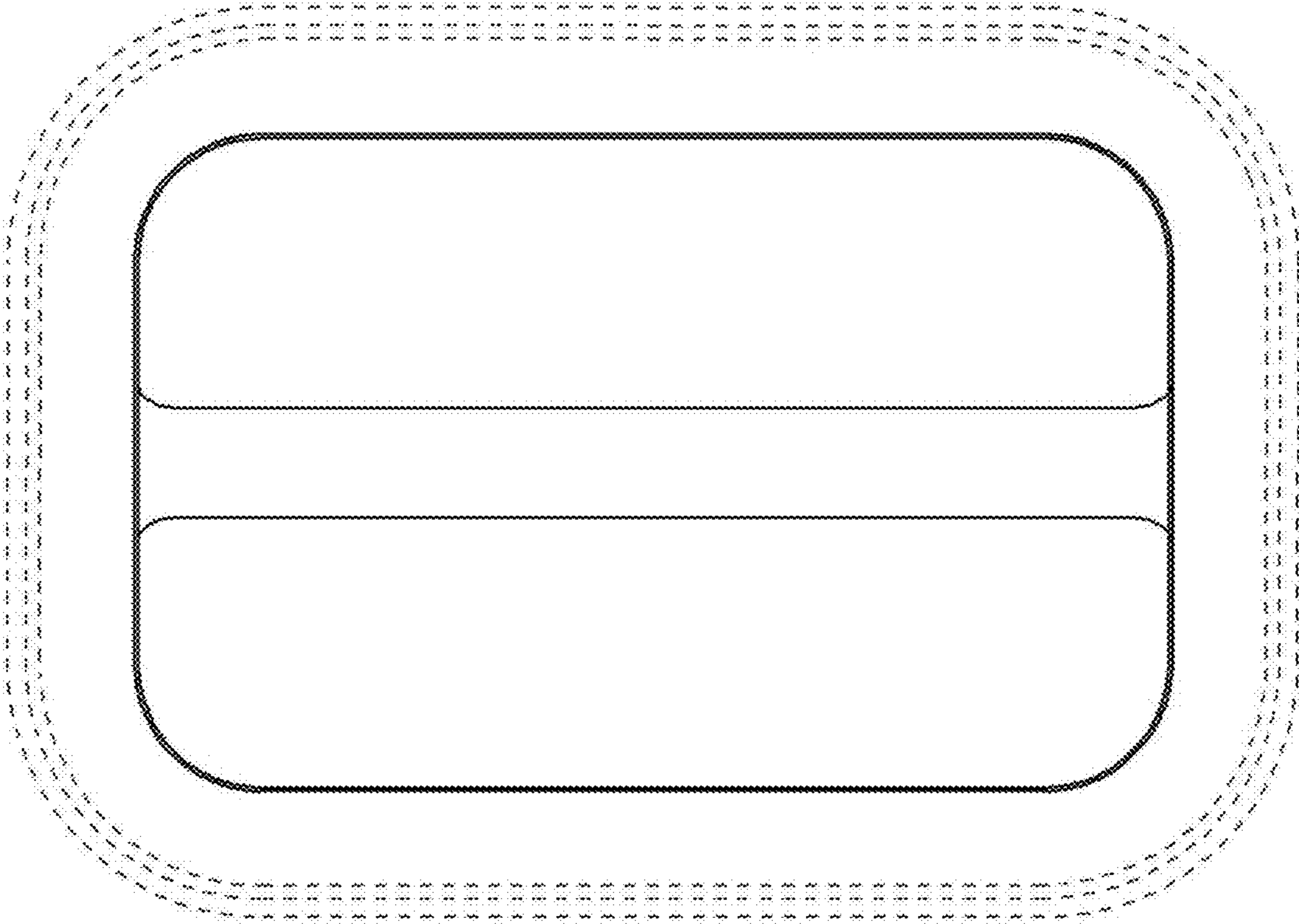

2.4

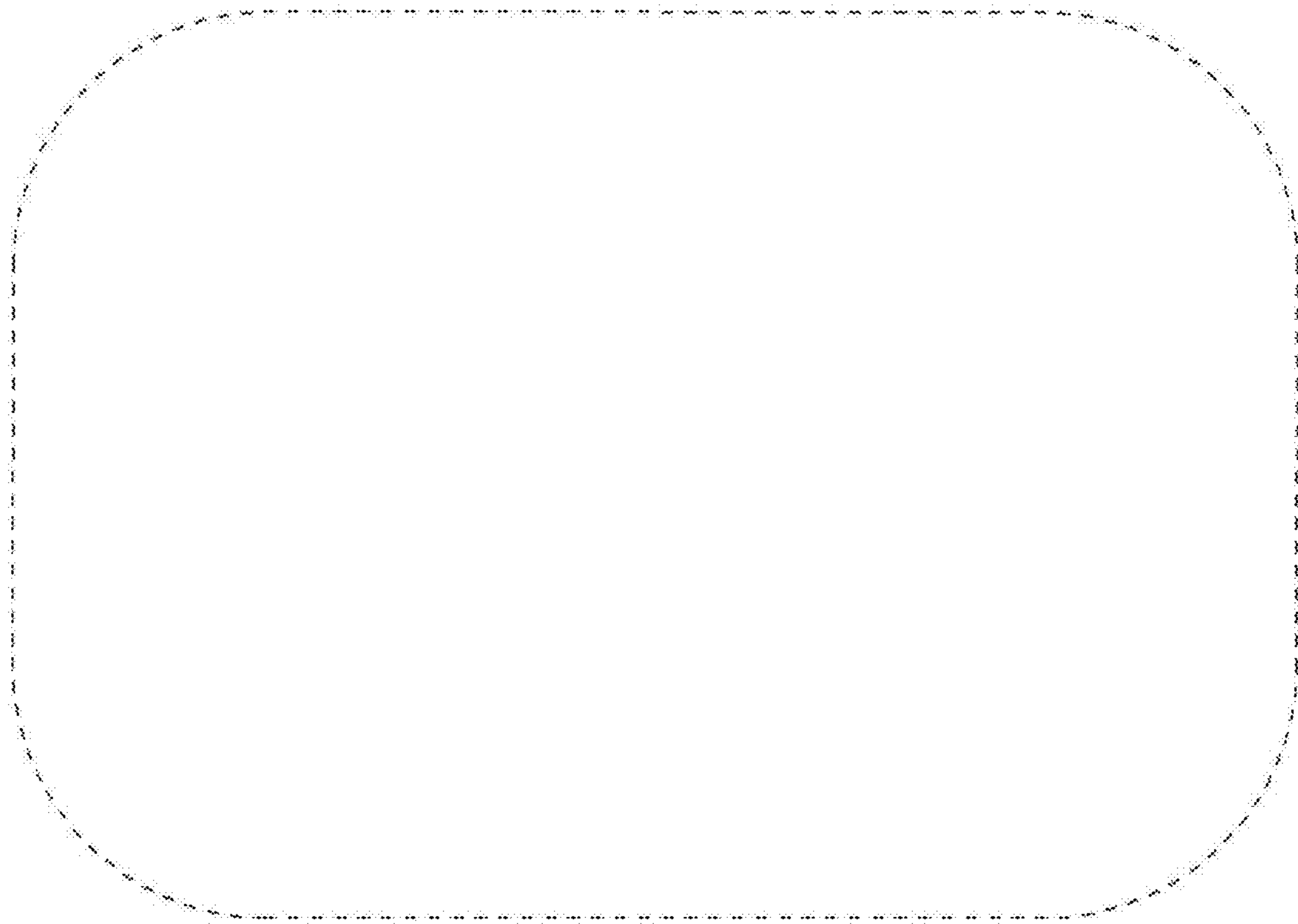

2.5

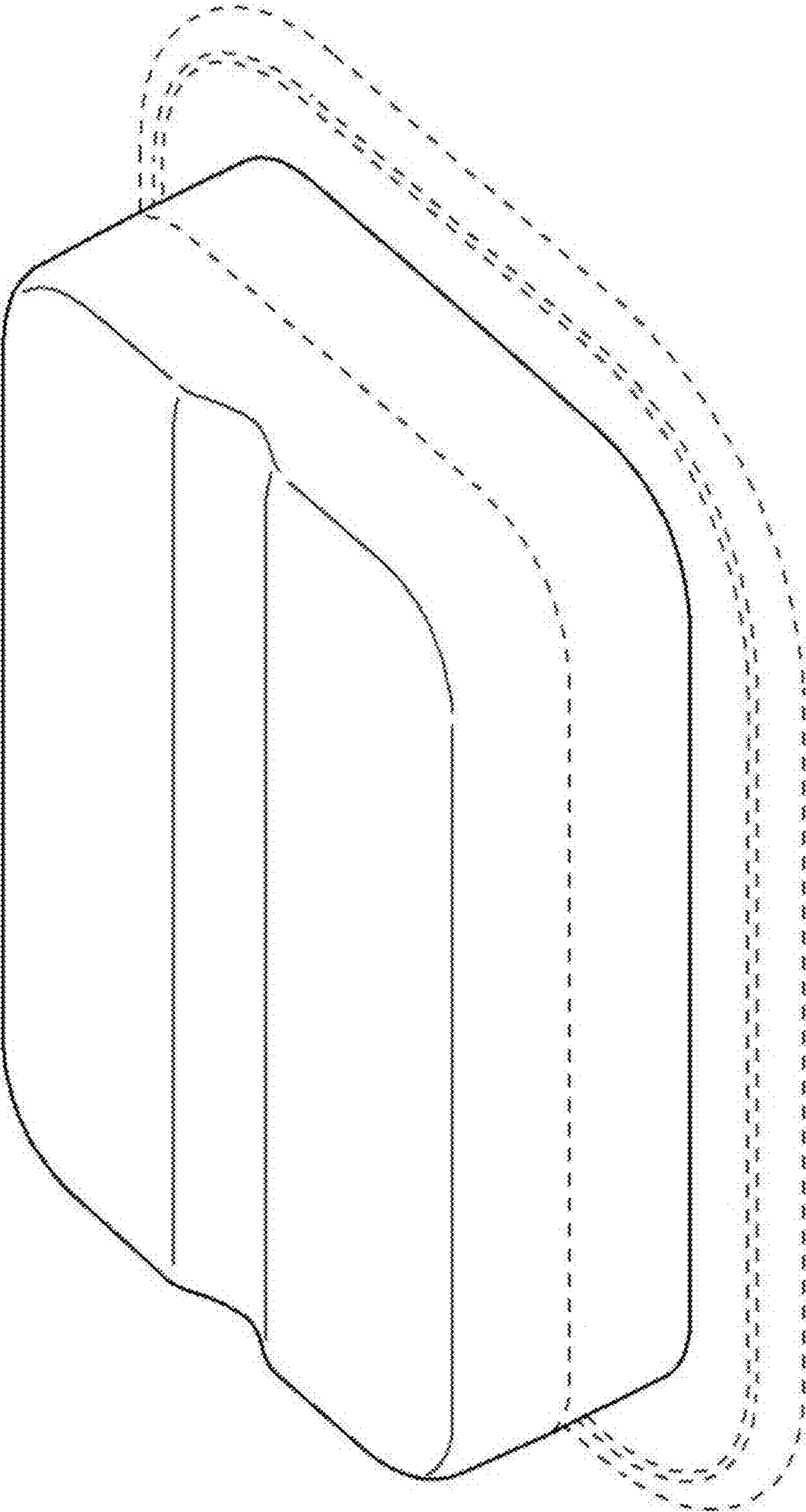

2.6

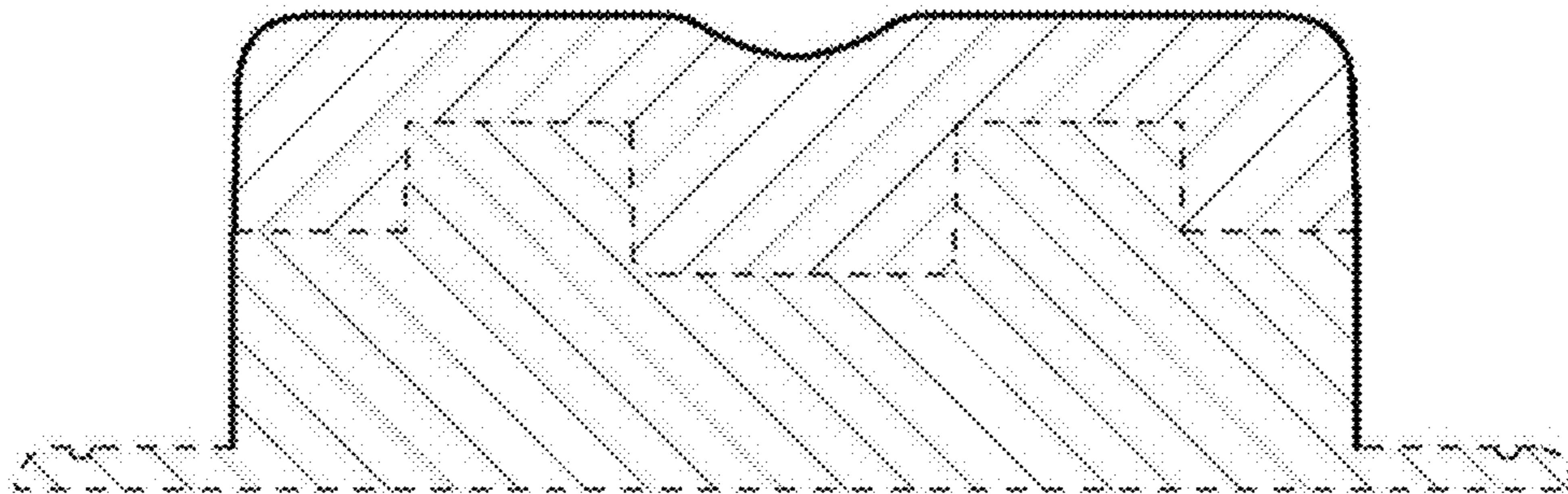

2.7

