

2012/0021738	A1	1/2012	Koo et al.	
2012/0022646	A1	1/2012	Montarino	
2012/0158134	A1	6/2012	Codori-Huff	
2012/0185041	A1	7/2012	Mortarino	
2012/0221105	A1	8/2012	Altman	
2012/0232653	A1	9/2012	Saint	
2012/0266348	A1*	10/2012	Meginnis	A41B 17/00 2/69
2012/0283826	A1	11/2012	Moses	
2013/0066423	A1	3/2013	Bishop	
2013/0103149	A1	4/2013	Altman	
2013/0178699	A1	7/2013	Saint	
2013/0178875	A1	7/2013	Horton	
2013/0253645	A1	9/2013	Kerr	
2013/0304098	A1	11/2013	Mortarino	
2014/0200396	A1	7/2014	Lashinsky	
2014/0222146	A1	8/2014	Moses	
2014/0222161	A1	8/2014	Moses	
2014/0276997	A1	9/2014	Harrah	
2015/0012089	A1	1/2015	Shetty	
2015/0018946	A1	1/2015	Guteman	
2015/0056131	A1	2/2015	Bernasconi	
2015/0223928	A1	8/2015	Limem	
2015/0351899	A1	12/2015	Mortarino	
2016/0038269	A1	2/2016	Altman	
2016/0151138	A1	6/2016	Guterman	

FOREIGN PATENT DOCUMENTS

WO	2004/096098	11/2004
WO	2006/117622	11/2006
WO	2009/001293	12/2008
WO	2011/119742	9/2011
WO	2012/122215	9/2012

OTHER PUBLICATIONS

Auclair, et al, "Repair of mammary ptosis by insertion of an internal absorbable support and periareolar scar," *Ann Chir Plast Esthet*, 1993, 38, No. 1, pp. 107-113.

DeBruijn, et al, "Mastopexy with Mesh Reinforcement: The Mechanical Characteristics of Polyester Mesh in the Female Breast," *Plast. Reconstr. Surg.* 124: 364, 2009.

Goes, "Periareolar mammoplasty: double skin technique with application of polyglactine or mixed mesh," *Plast. Reconstr. Surg.*, 97-859-68 (1996).

Goes, "Periareolar Mastopexy with FortaPerm," *Aesth. Plast. Surg.*, 34-350-8, 2010.

Goes, "Periareolar mammoplasty: double-skin technique with application of mesh support," *Clin Plastic Surg* 29 (2002) 349-364.

Johnson, "Central core reduction mammoplasties and Marlex suspension of breast tissue".

P. van Deventer, Improving the Longevity and Results of Mastopexy and Breast Reduction Procedures: Reconstructing an Internal Breast Support System with Biocompatible Mesh to Replace the Supporting Function of the Ligamentous Suspension, *Aesth Plast Surg* (2012) 36:578-589, DOI 10.1007/s00266-011-9845-2.

Williams, "Poly-4-hydroxybutyrate (P4HB): a new generation of resorbable medical devices for tissue repair and regeneration," DOI 10.1515/bmt-2013-0009 *Biomed Tech* 2013; 58(5): 439-452.

European Examination Report dated Mar. 14, 2017, for 12754773. 5-1666.

Written Opinion of ISR dated Nov. 5, 2012 for PCT/US2012/027975.

"GalaFLEX Mesh . . . Supporting Your Quest for Timeless Beauty," Tepha, Inc. 400109 Rev.B, Oct. 2012.

"GalaFLEX Mesh," Tepha Inc., www.galateasurgical.com, P/N 400124, Rev.A, Oct. 2013.

Supplementary European Search Report of the EPO dated Jul. 30, 2014, EP 12754773.5 from PCT/US2012/027075.

Written Opinion of IPEA dated Jun. 15, 2015 for PCT/US2014/046420.

Hans P. deBruijn, Siegmund Johannes, "Mastopexy with 3D Preshaped Mesh for Long Term Results: Development of the Internal Bra System," *Aesth Plast Surg.*, 32:757-765, DOI 10.1007/s00266-008-9186-y, 2008.

* cited by examiner

Primary Examiner — Charles D Hanson
(74) *Attorney, Agent, or Firm* — Convergent Law Group LLP; Richard Batt

(57) **CLAIM**

The ornamental design for a three dimensional mastopexy implant, as shown and described.

DESCRIPTION

FIG. 1 is a front view of a three dimensional mastopexy implant showing our new design;
 FIG. 2 is a top view of the three dimensional mastopexy implant shown in FIG. 1;
 FIG. 3 is a side view of the three dimensional mastopexy implant shown in FIG. 1;
 FIG. 4 is a bottom view of the three dimensional mastopexy implant shown in FIG. 1;
 FIG. 5 is another side view of the three dimensional mastopexy implant shown in FIG. 1;
 FIG. 6 is a rear view of the three dimensional mastopexy implant shown in FIG. 1
 FIG. 7 is a top, front, side perspective view of the three dimensional mastopexy implant shown in FIG. 1;
 FIG. 8 is a front view of another three dimensional mastopexy implant showing our new design;
 FIG. 9 is a top view of the three dimensional mastopexy implant shown in FIG. 8;
 FIG. 10 is a side view of the three dimensional mastopexy implant shown in FIG. 8;
 FIG. 11 is a bottom view of the three dimensional mastopexy implant shown in FIG. 8;
 FIG. 12 is another side view of the three dimensional mastopexy implant shown in FIG. 8;
 FIG. 13 is a rear view of the three dimensional mastopexy implant shown in FIG. 8;
 FIG. 14 is a top, front, side perspective view of the three dimensional mastopexy implant shown in FIG. 8;
 FIG. 15 is a front view of another three dimensional mastopexy implant showing our new design;
 FIG. 16 is a top view of the three dimensional mastopexy implant shown in FIG. 15;
 FIG. 17 is a side view of the three dimensional mastopexy implant shown in FIG. 15;
 FIG. 18 is a bottom view of the three dimensional mastopexy implant shown in FIG. 15;
 FIG. 19 is another side view of the three dimensional mastopexy implant shown in FIG. 15;
 FIG. 20 is a rear view of the three dimensional mastopexy implant shown in FIG. 15;
 FIG. 21 is a top, front, side perspective view of the three dimensional mastopexy implant shown in FIG. 15;
 FIG. 22 is a front view of another three dimensional mastopexy implant showing our new design;
 FIG. 23 is a top view of the three dimensional mastopexy implant shown in FIG. 22;
 FIG. 24 is a side view of the three dimensional mastopexy implant shown in FIG. 22;

FIG. **25** is a bottom view of the three dimensional mastopexy implant shown in FIG. **22**;

FIG. **26** is another side view of the three dimensional mastopexy implant shown in FIG. **22**;

FIG. **27** is a rear view of the three dimensional mastopexy implant shown in FIG. **22**; and,

FIG. **28** is a top, front, side perspective view of the three dimensional mastopexy implant shown in FIG. **22**.

The broken lines shown in the figures form no part of the claimed design.

1 Claim, 25 Drawing Sheets

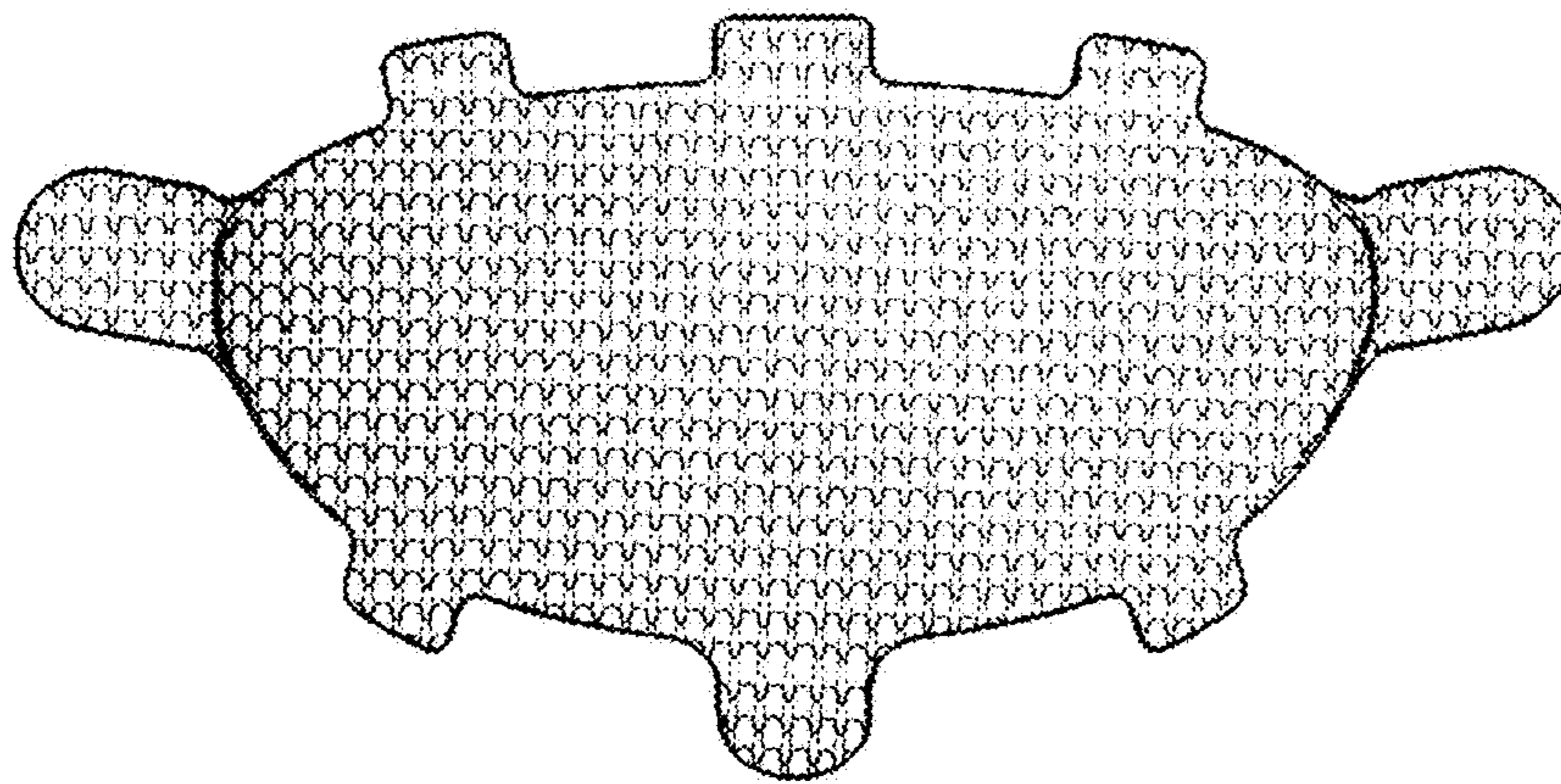

Figure 1

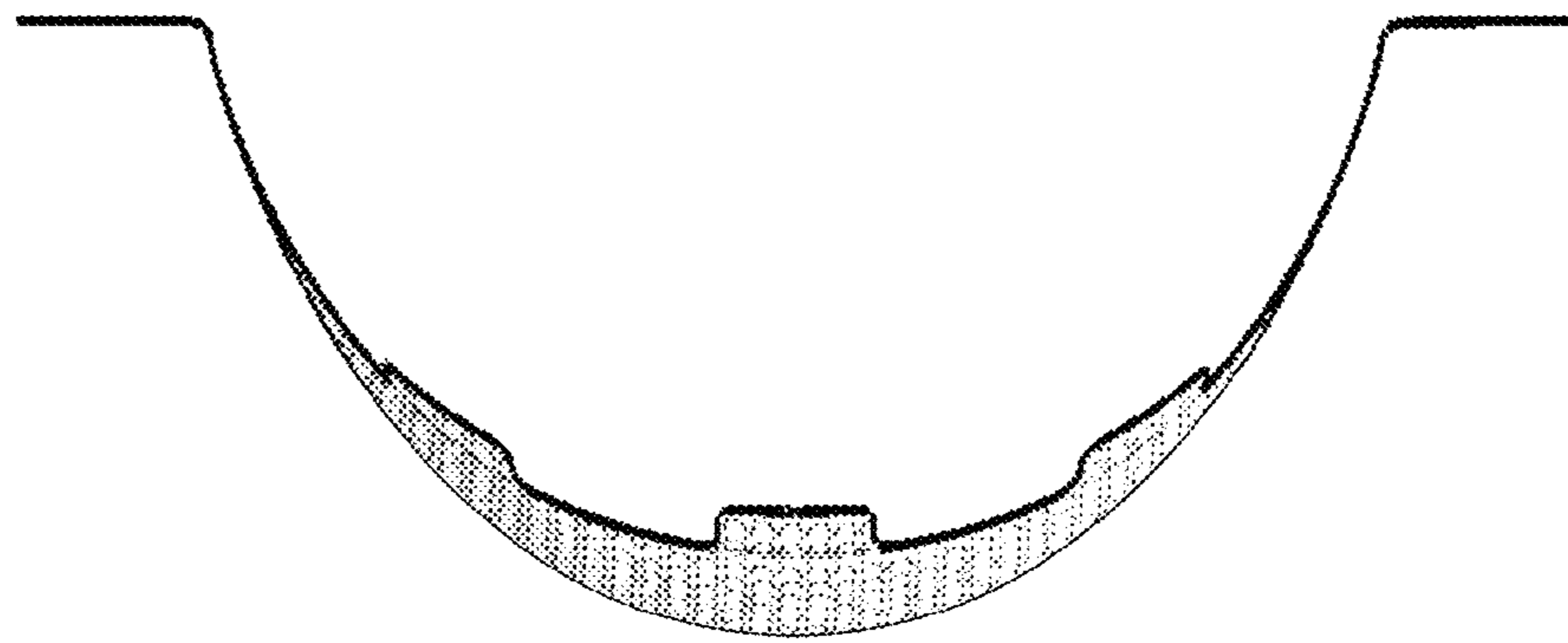

Figure 2

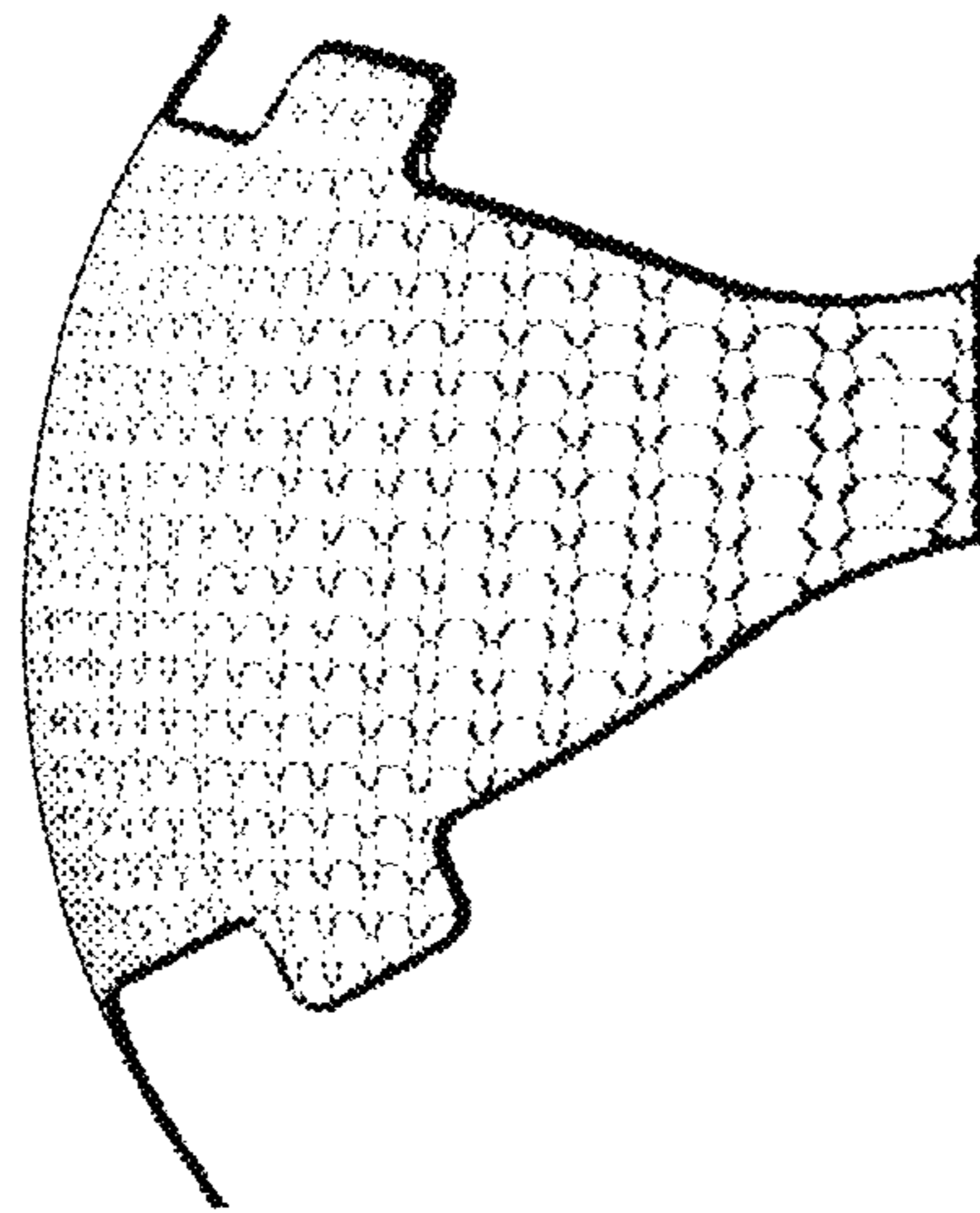

Figure 3

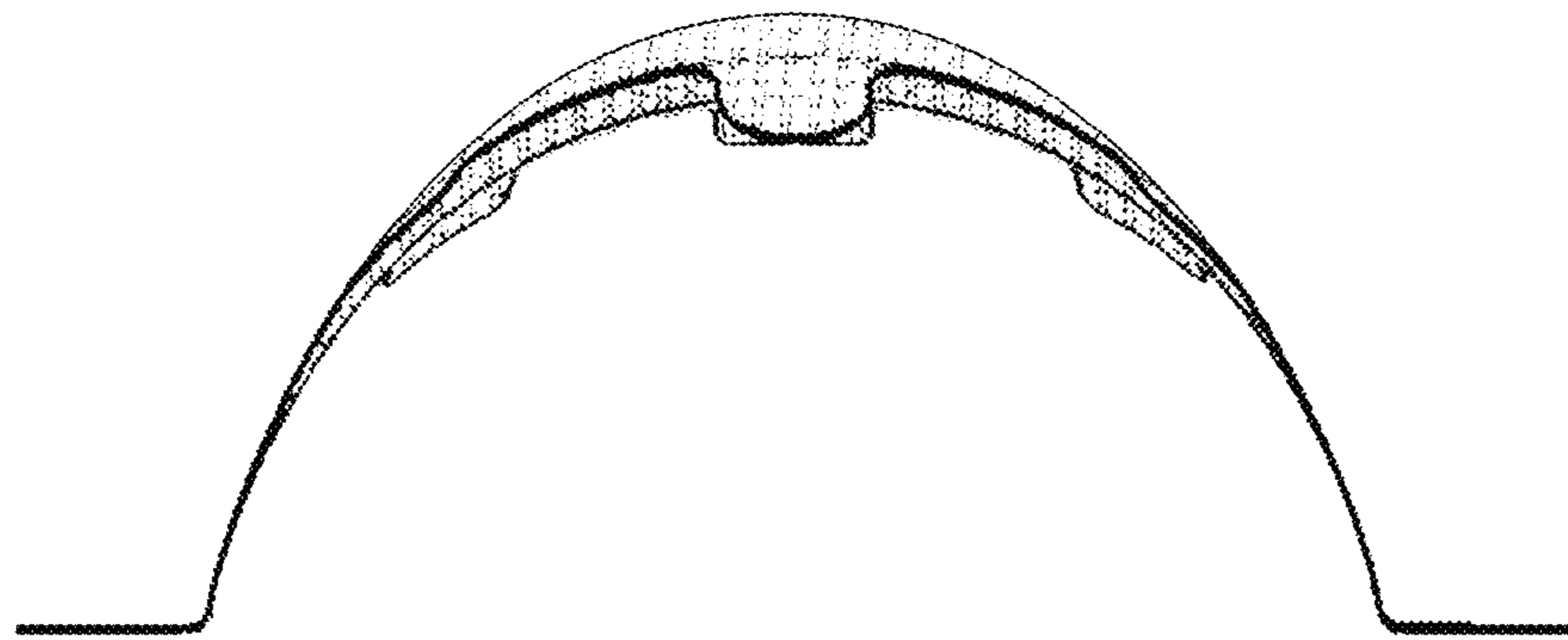

Figure 4

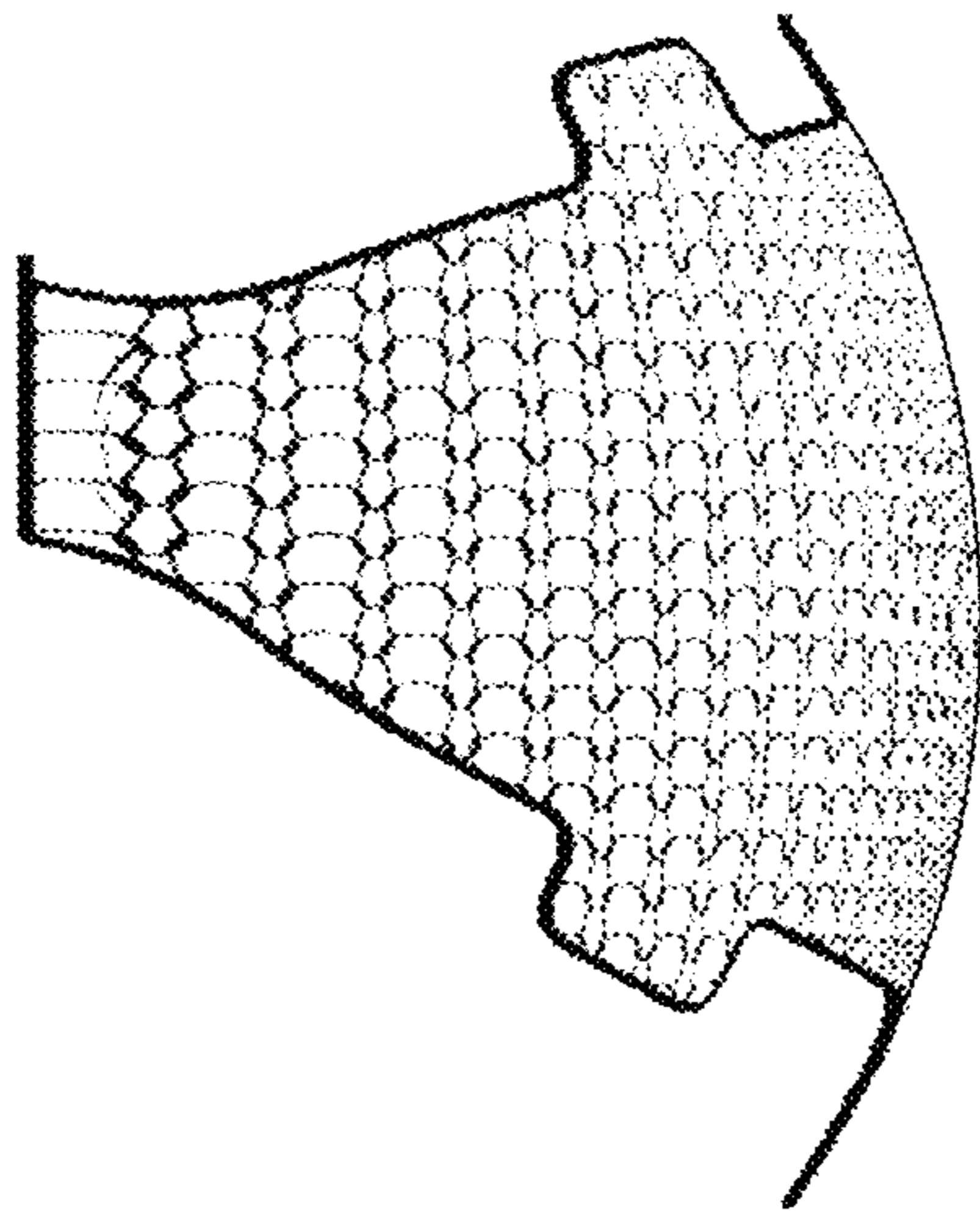

Figure 5

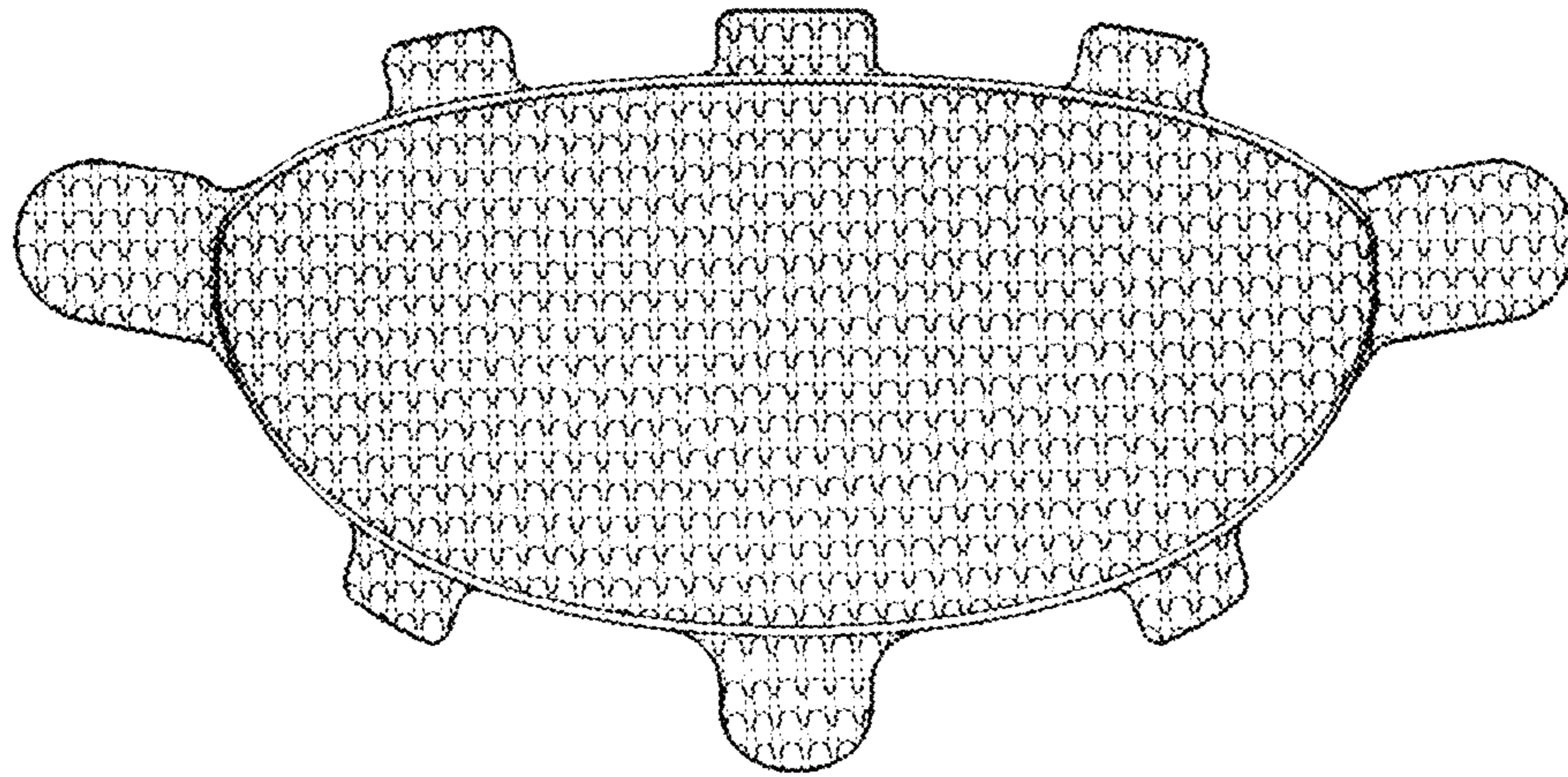

Figure 6

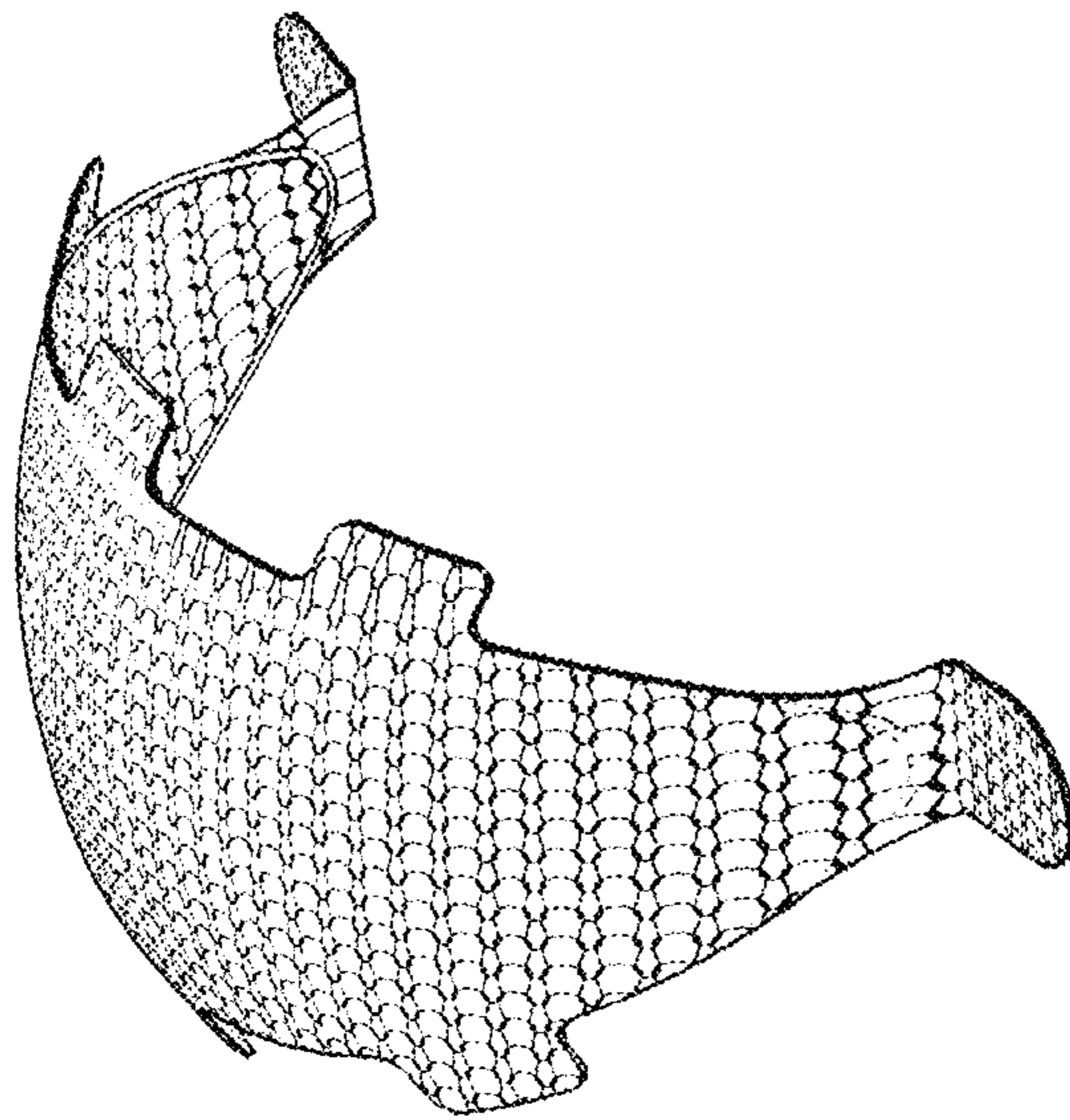

Figure 7

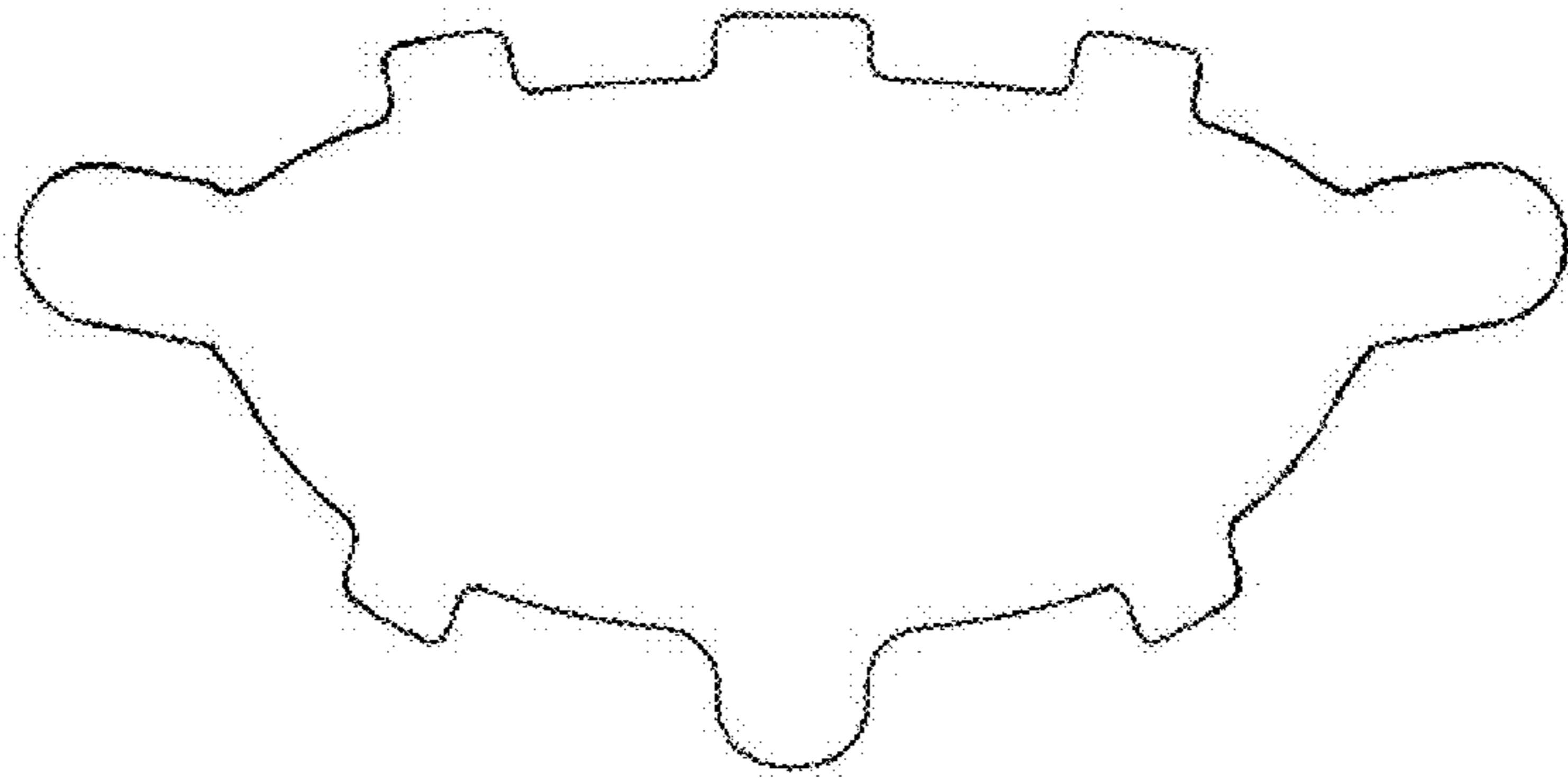

Figure 8

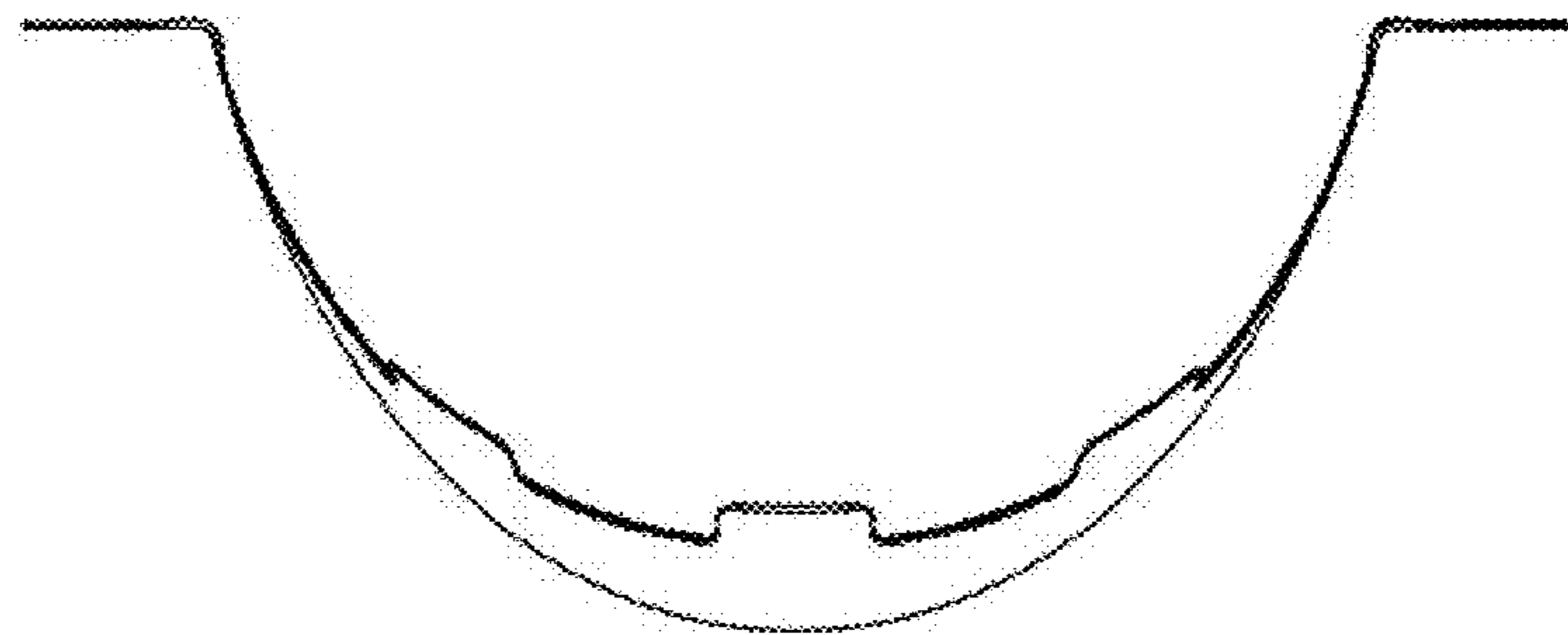

Figure 9

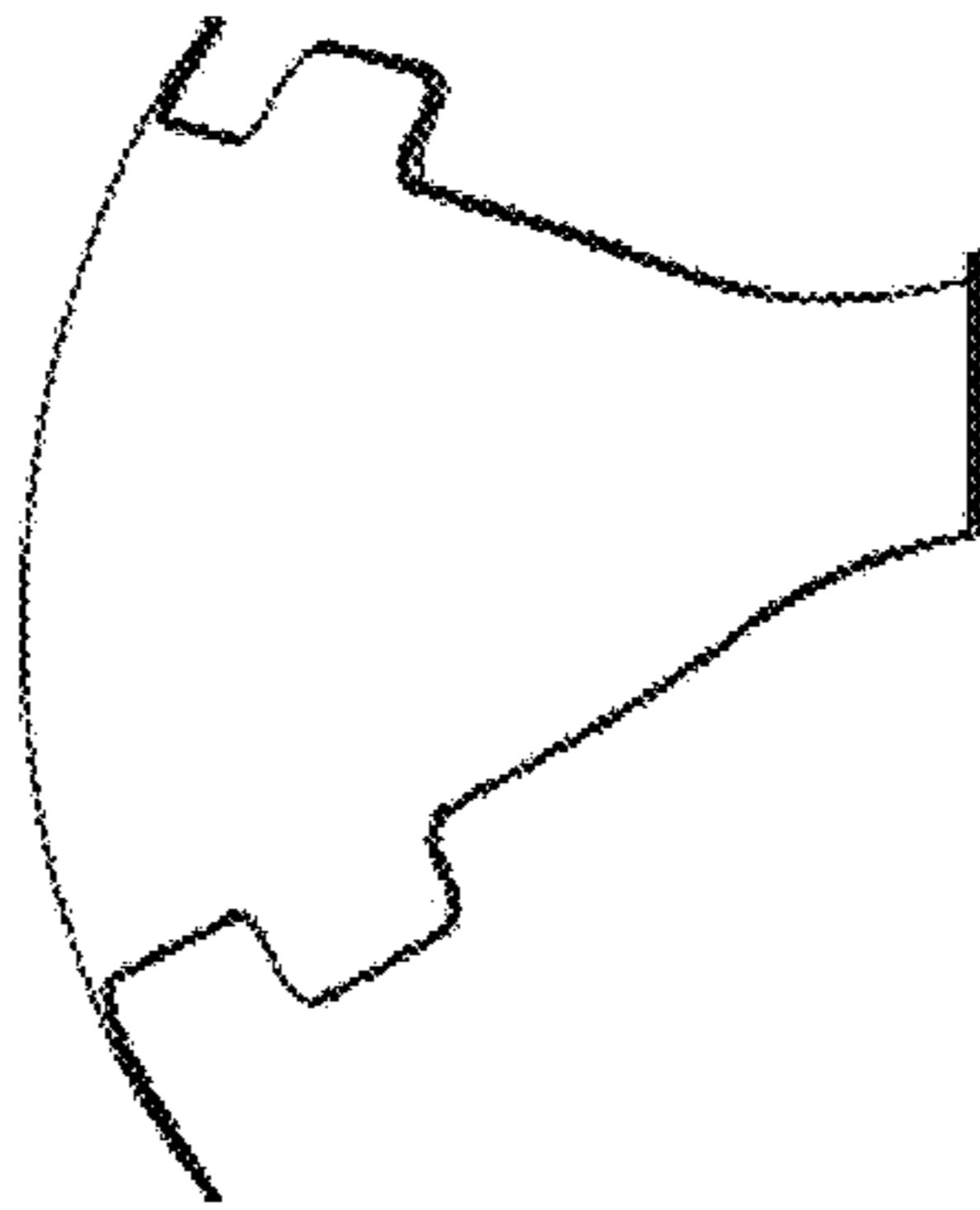

Figure 10

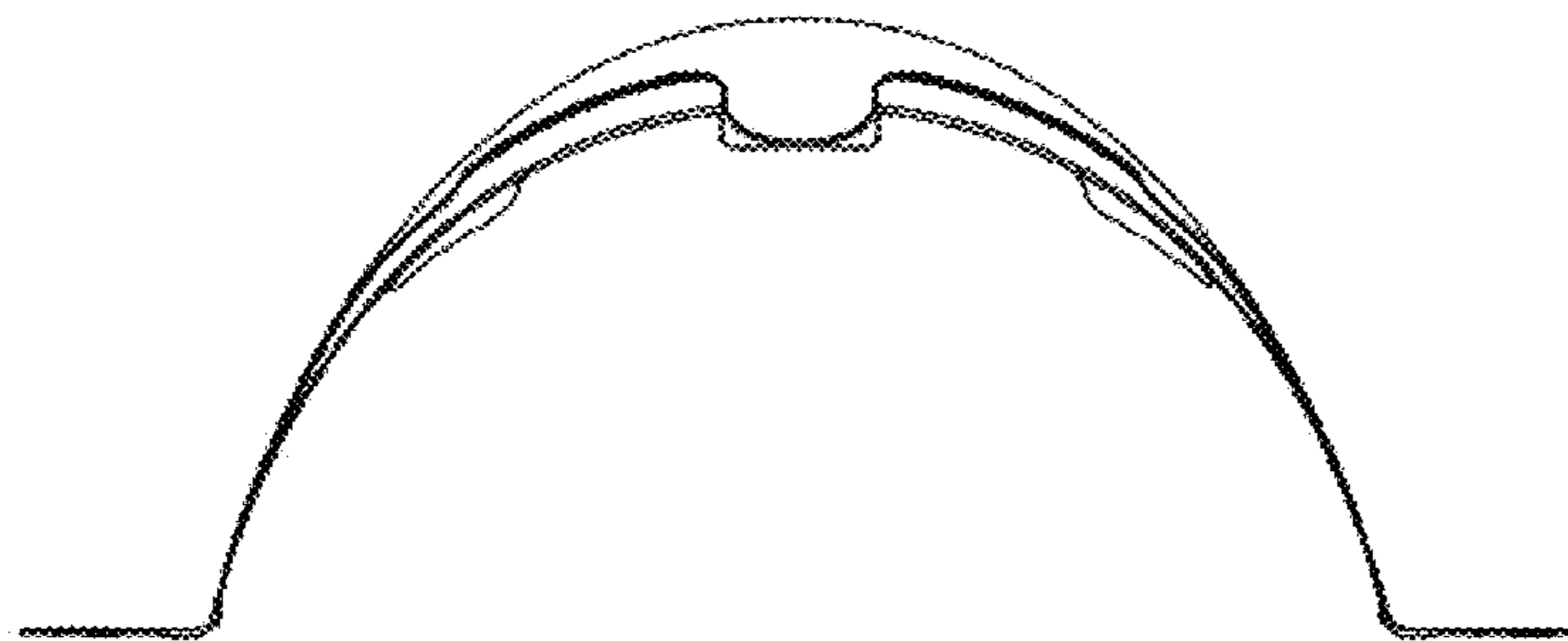

Figure 11

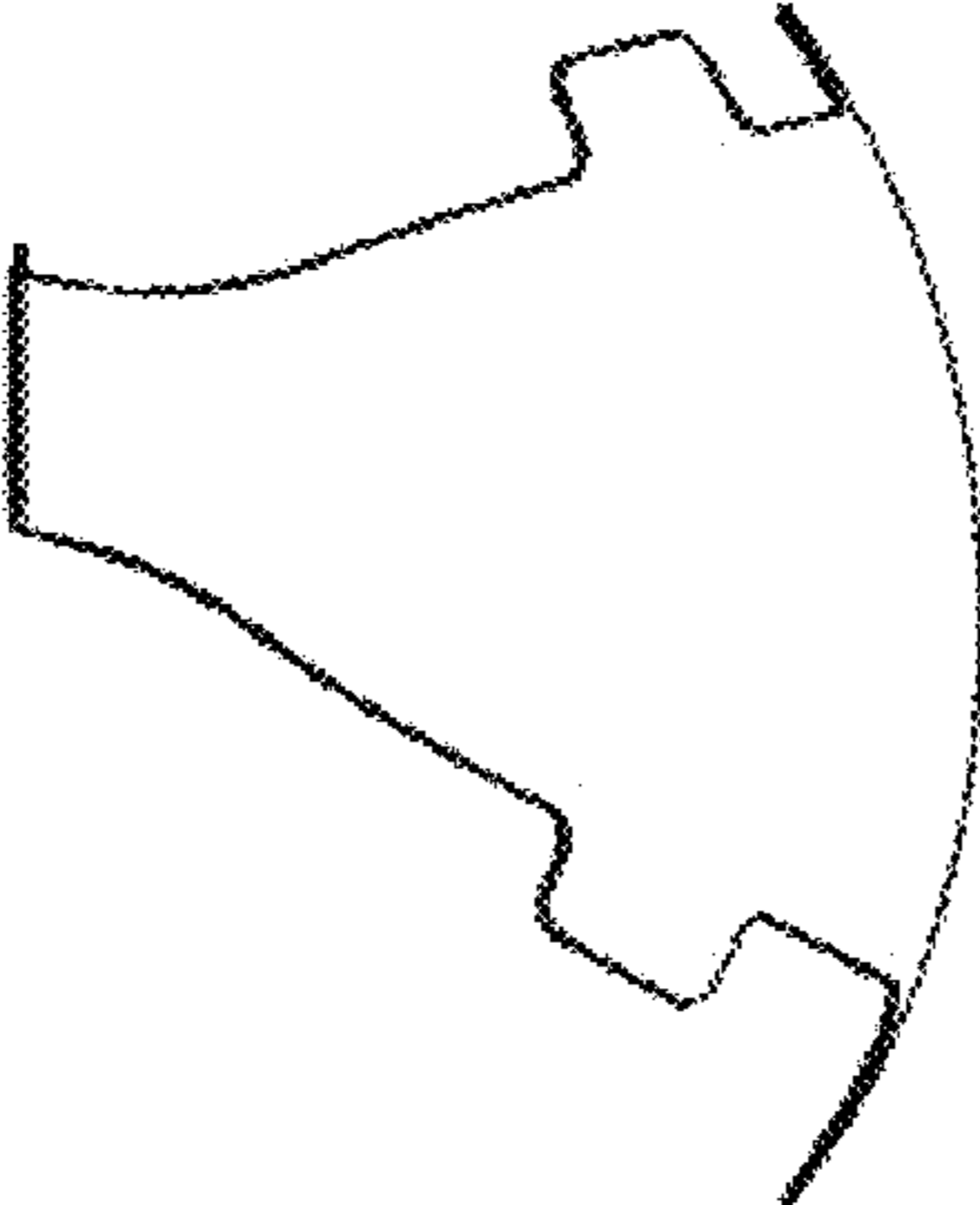

Figure 12

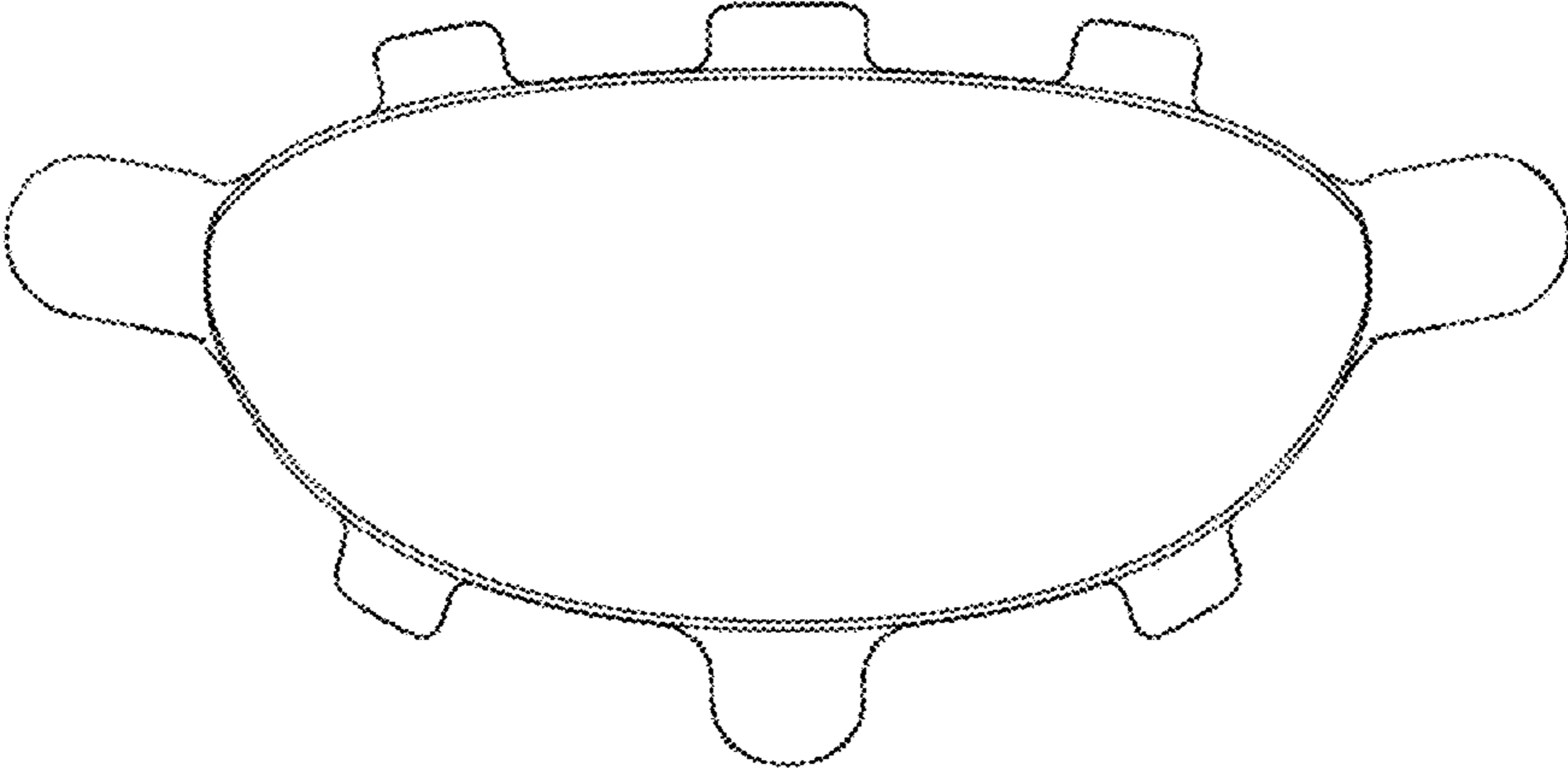

Figure 13

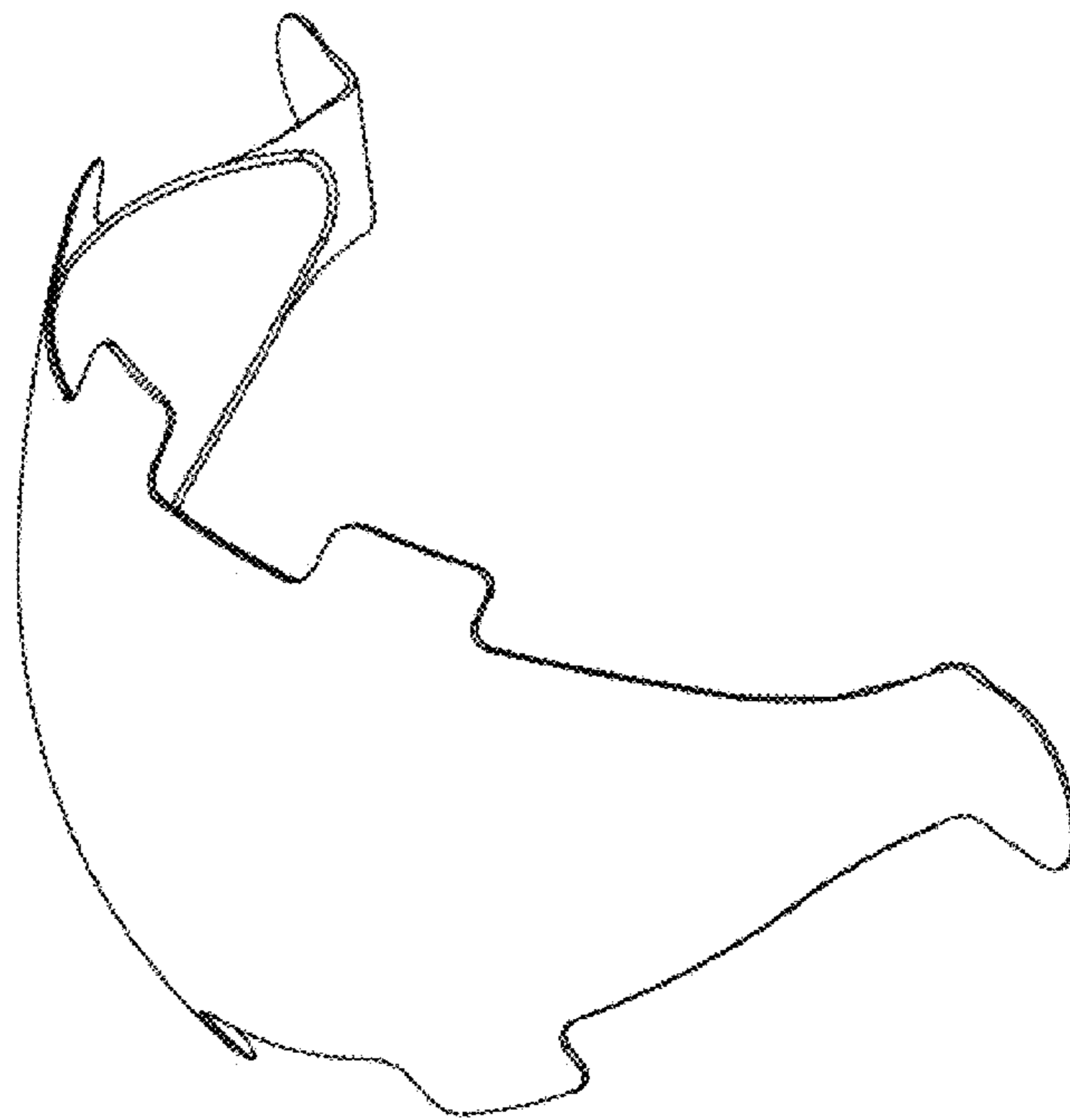

Figure 14

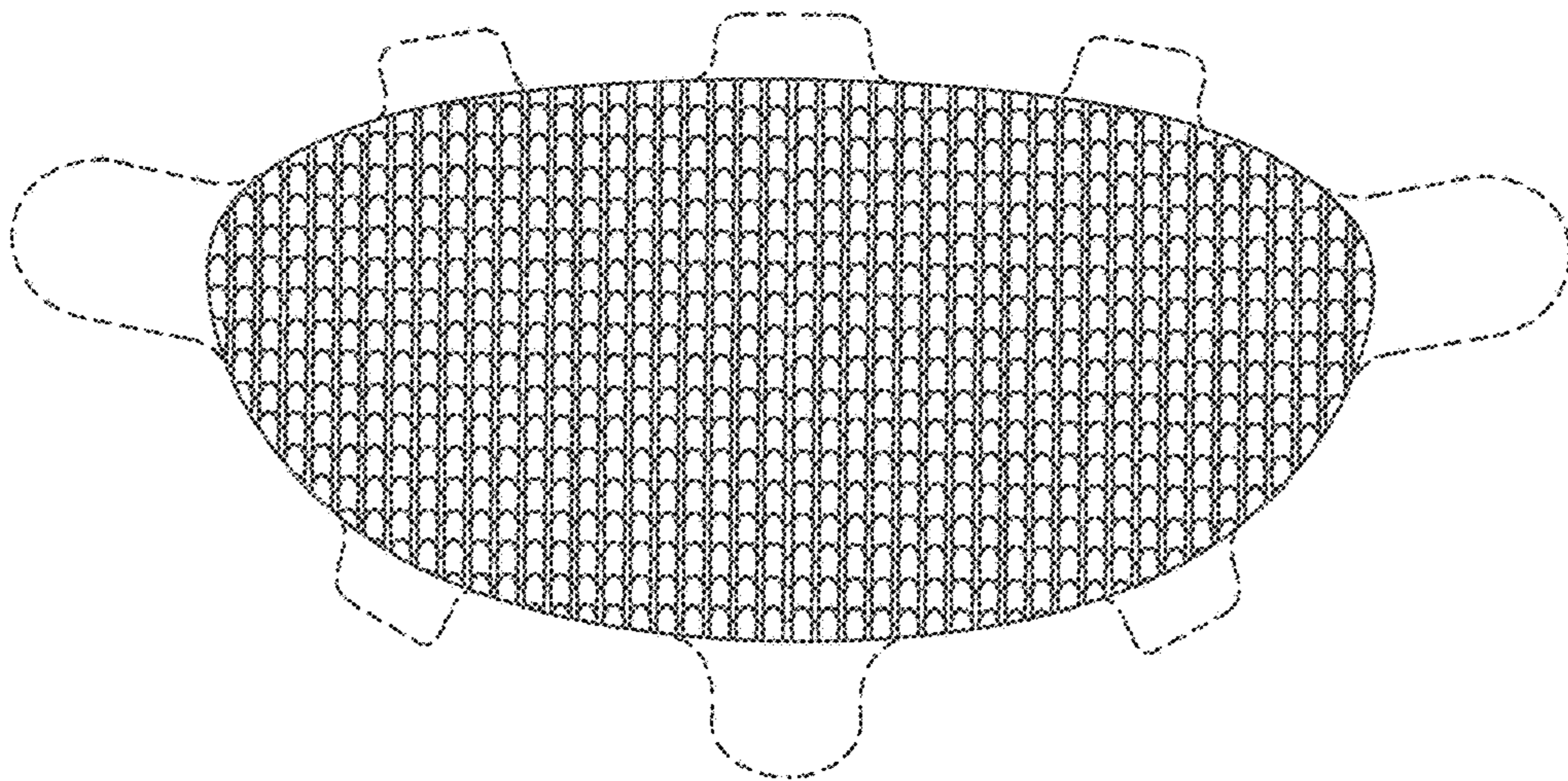

Figure 15

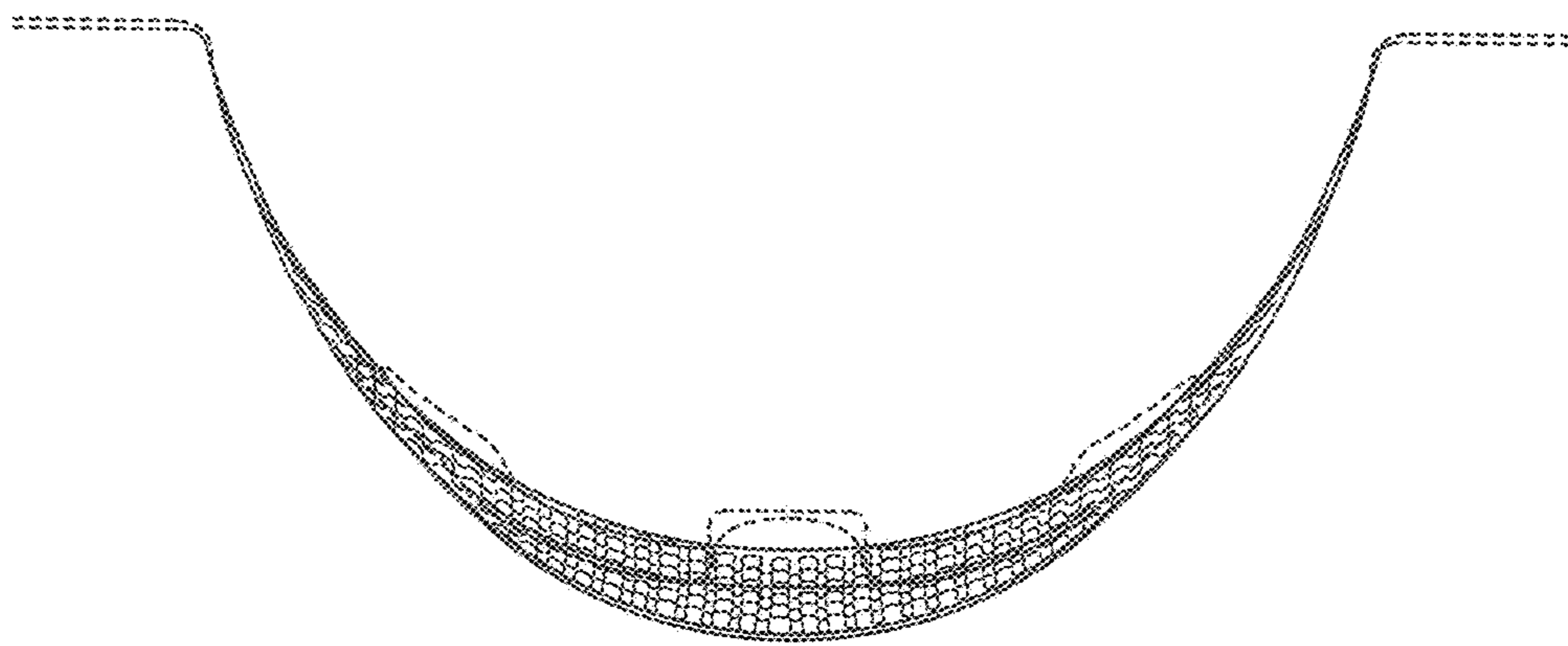

Figure 16

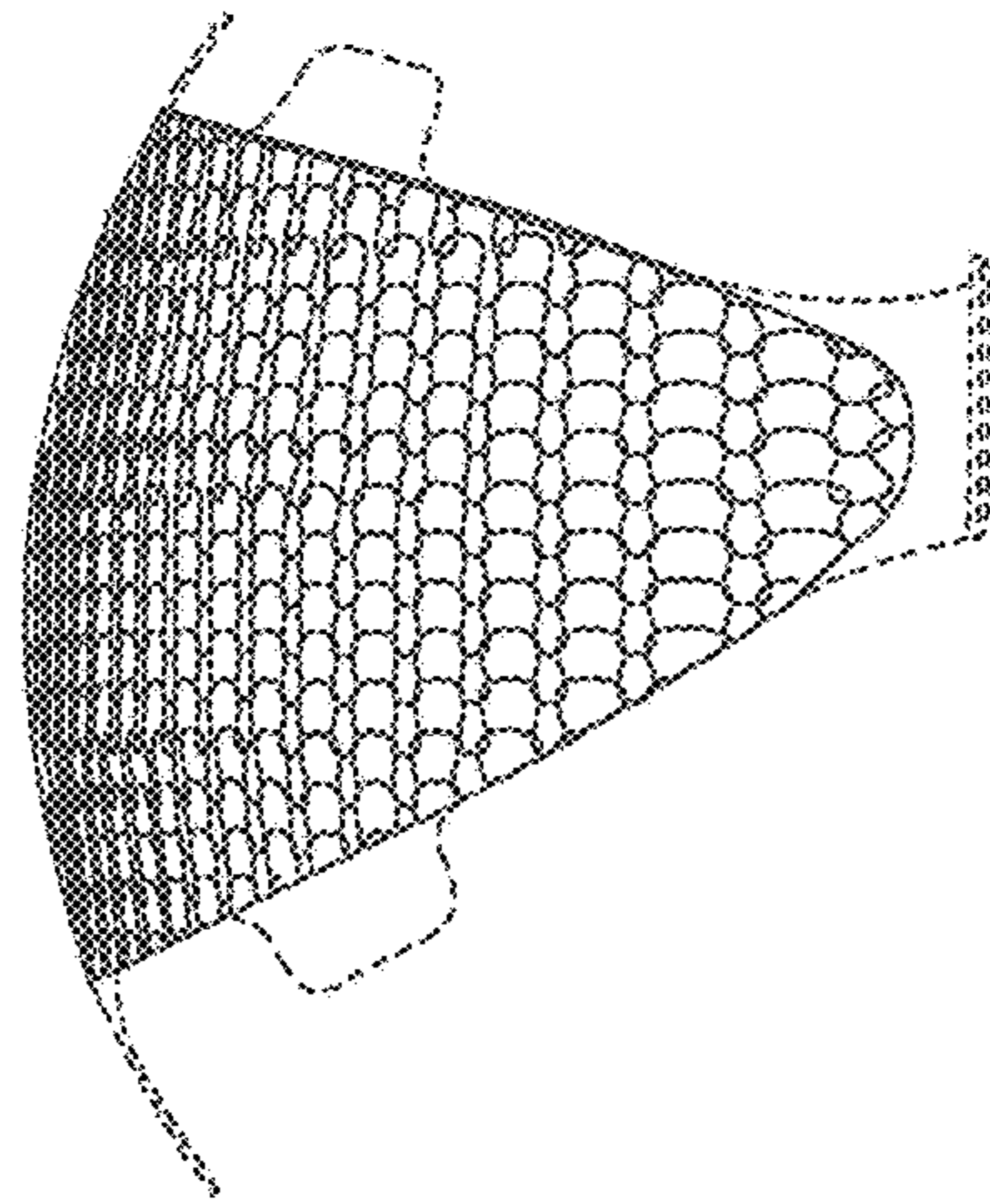

Figure 17

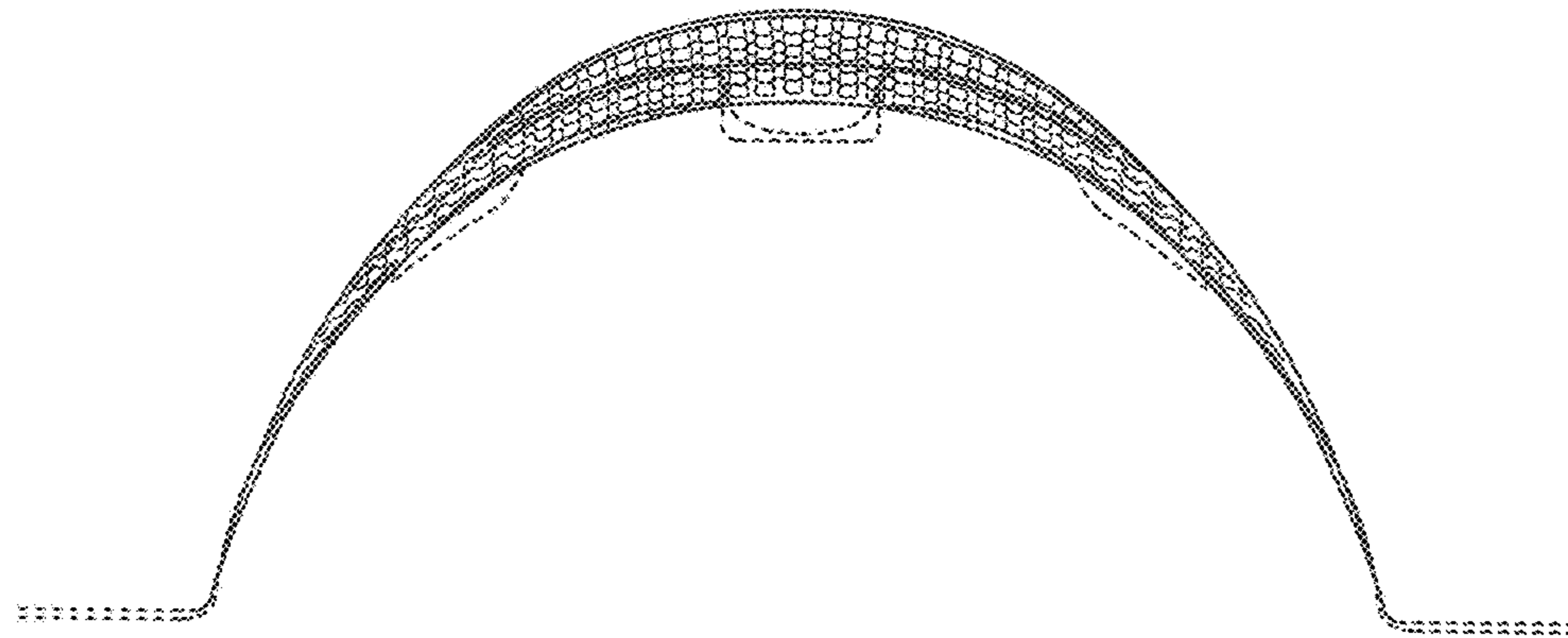

Figure 18

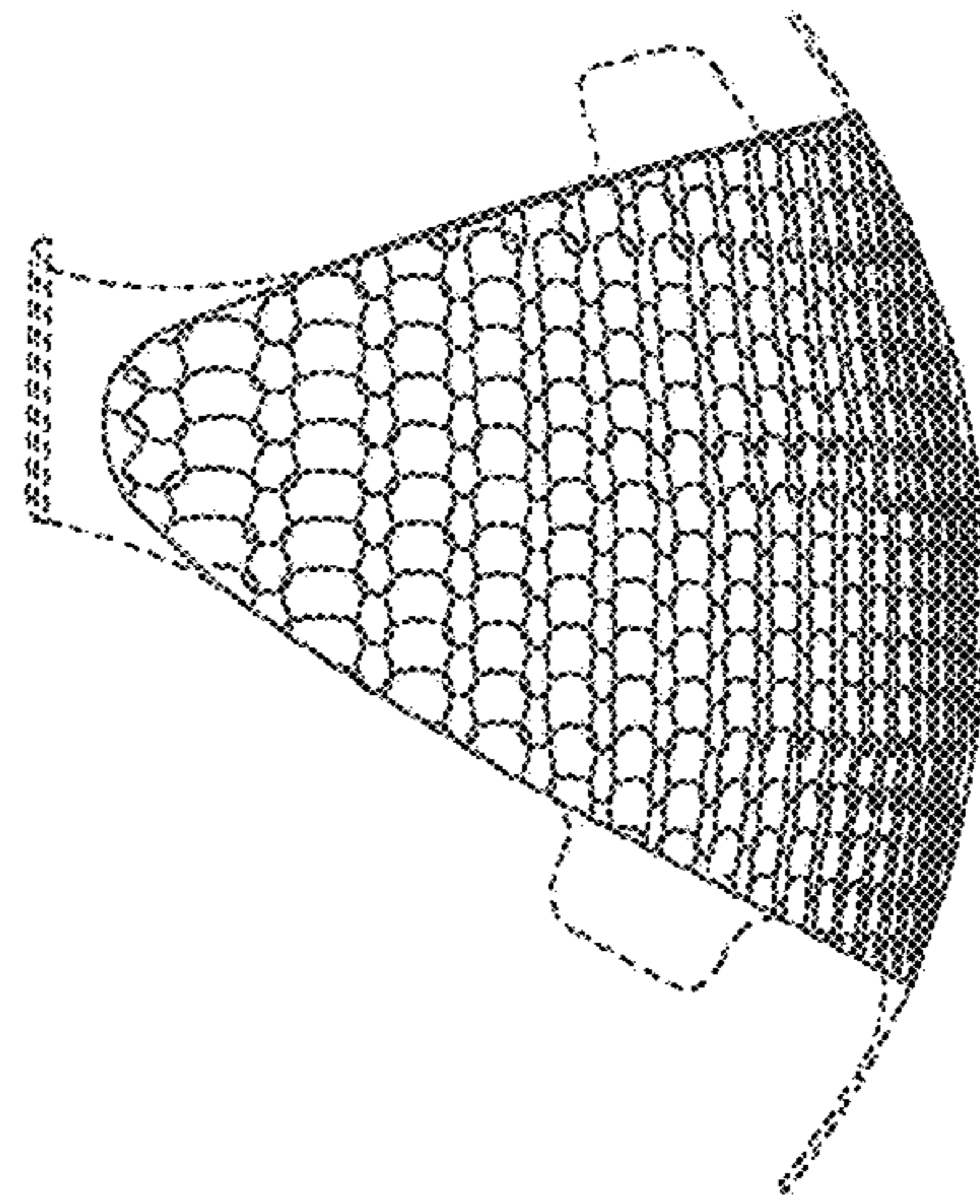

Figure 19

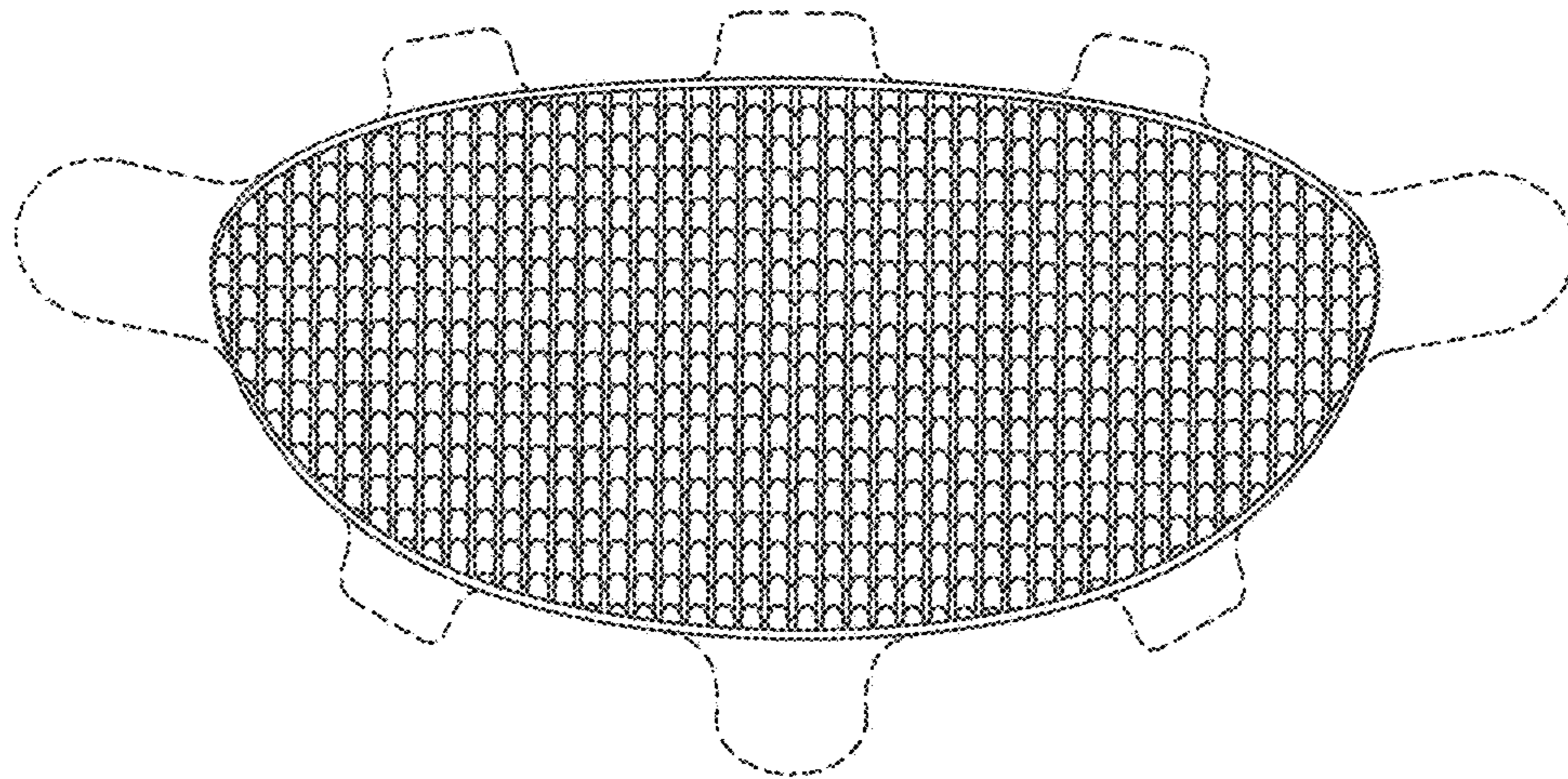

Figure 20

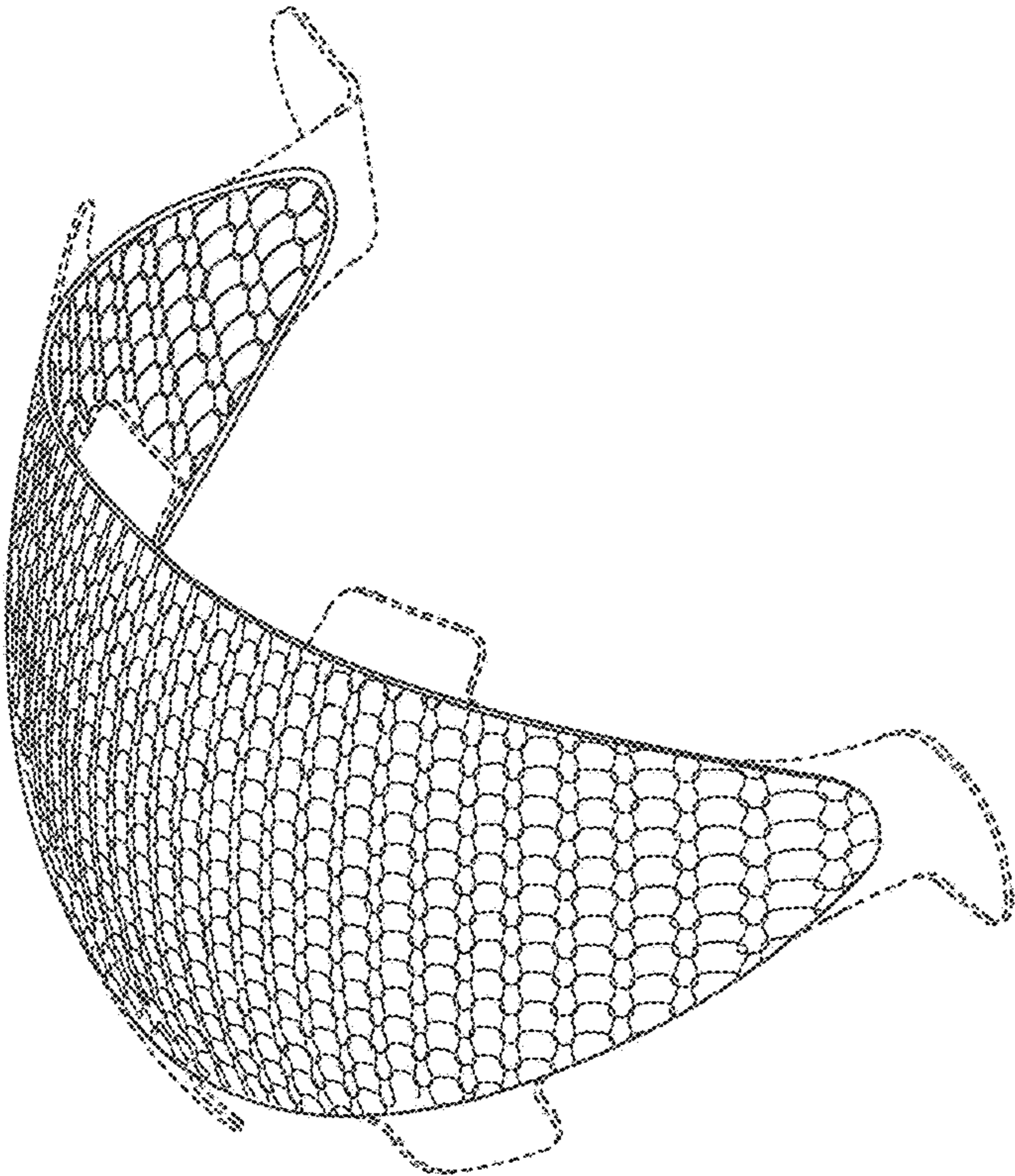

Figure 21

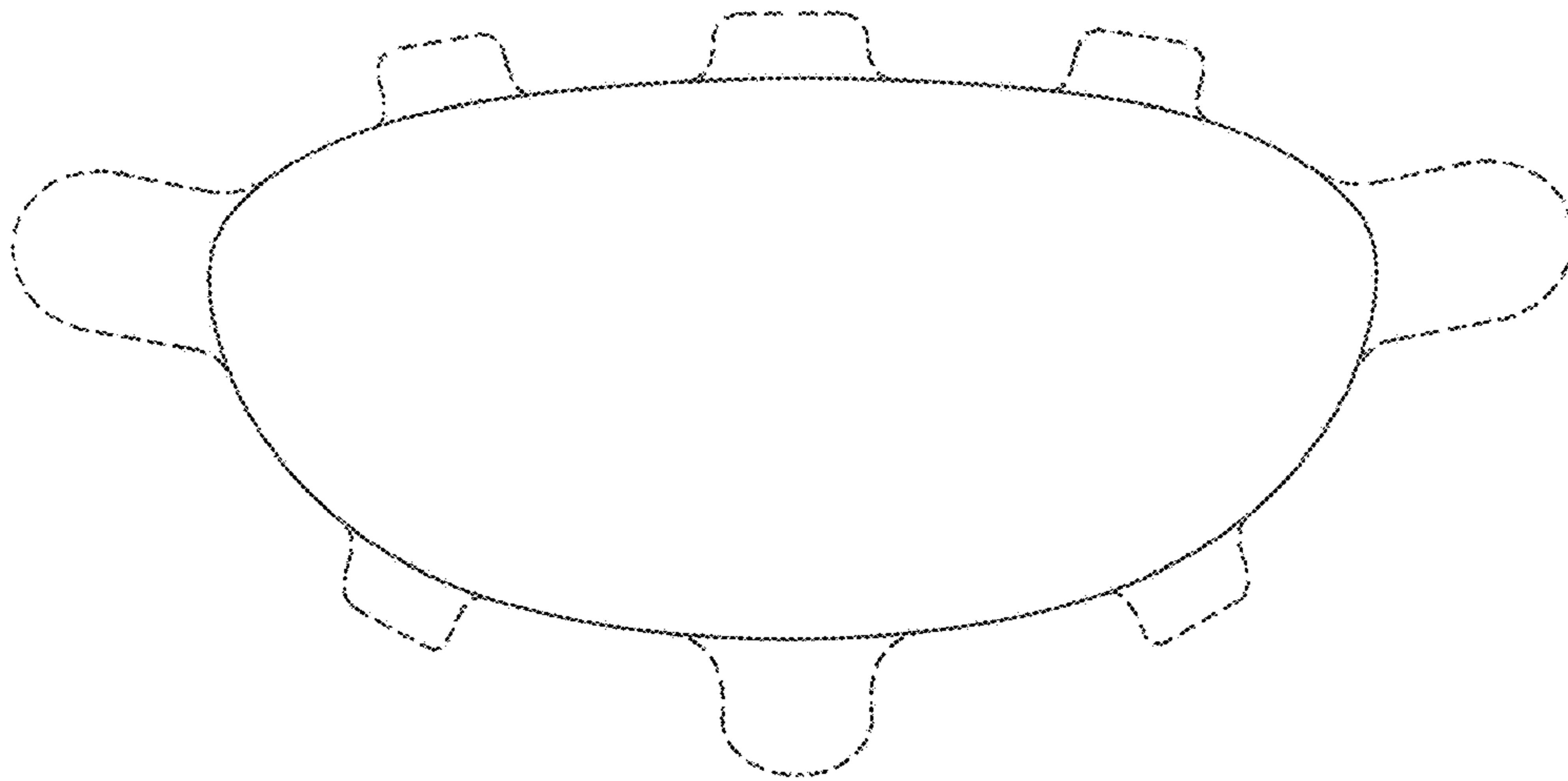

Figure 22

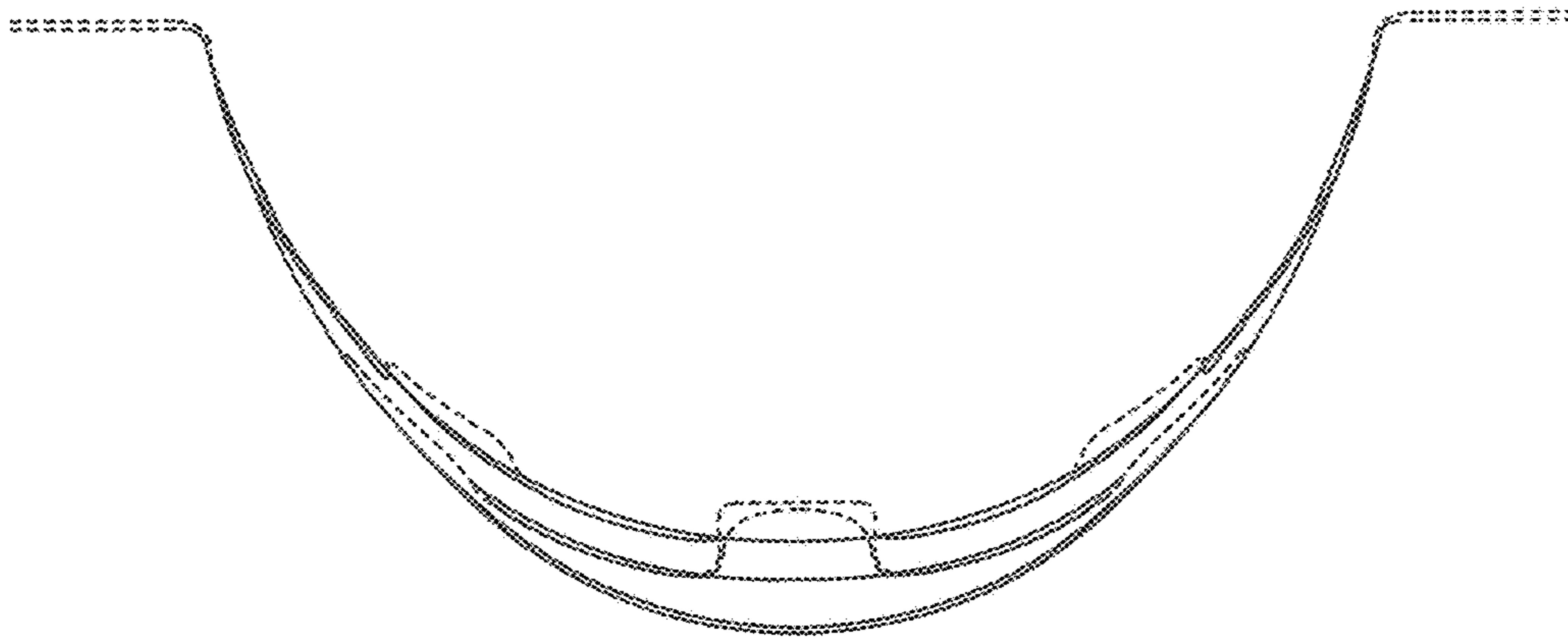

Figure 23

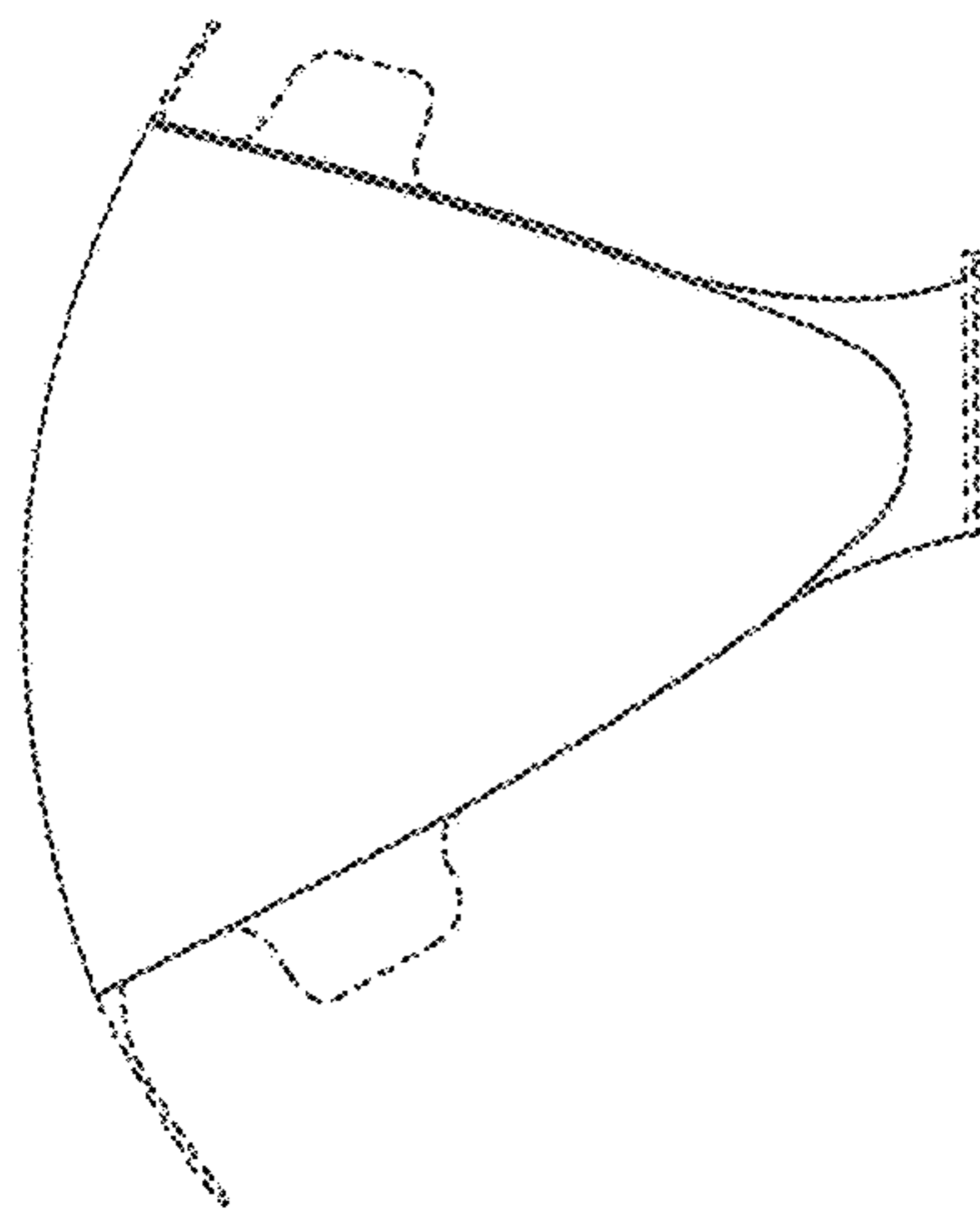

Figure 24

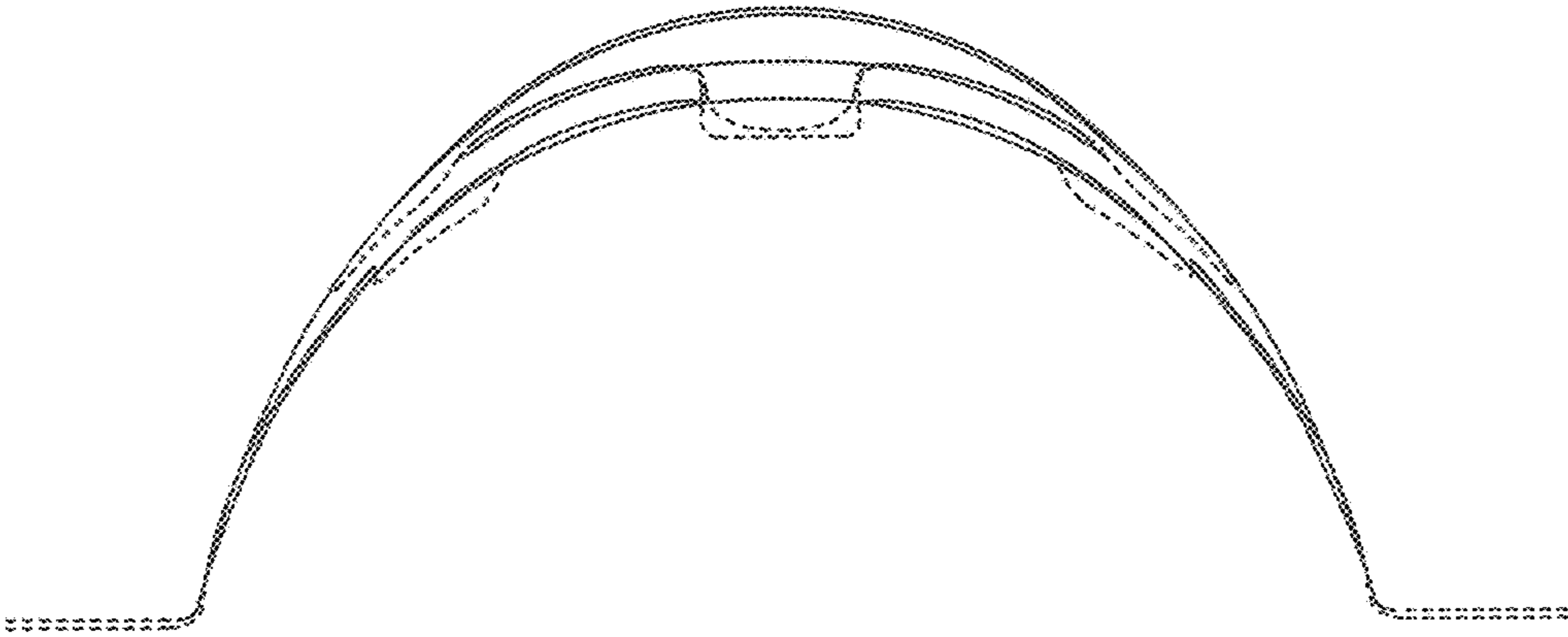

Figure 25

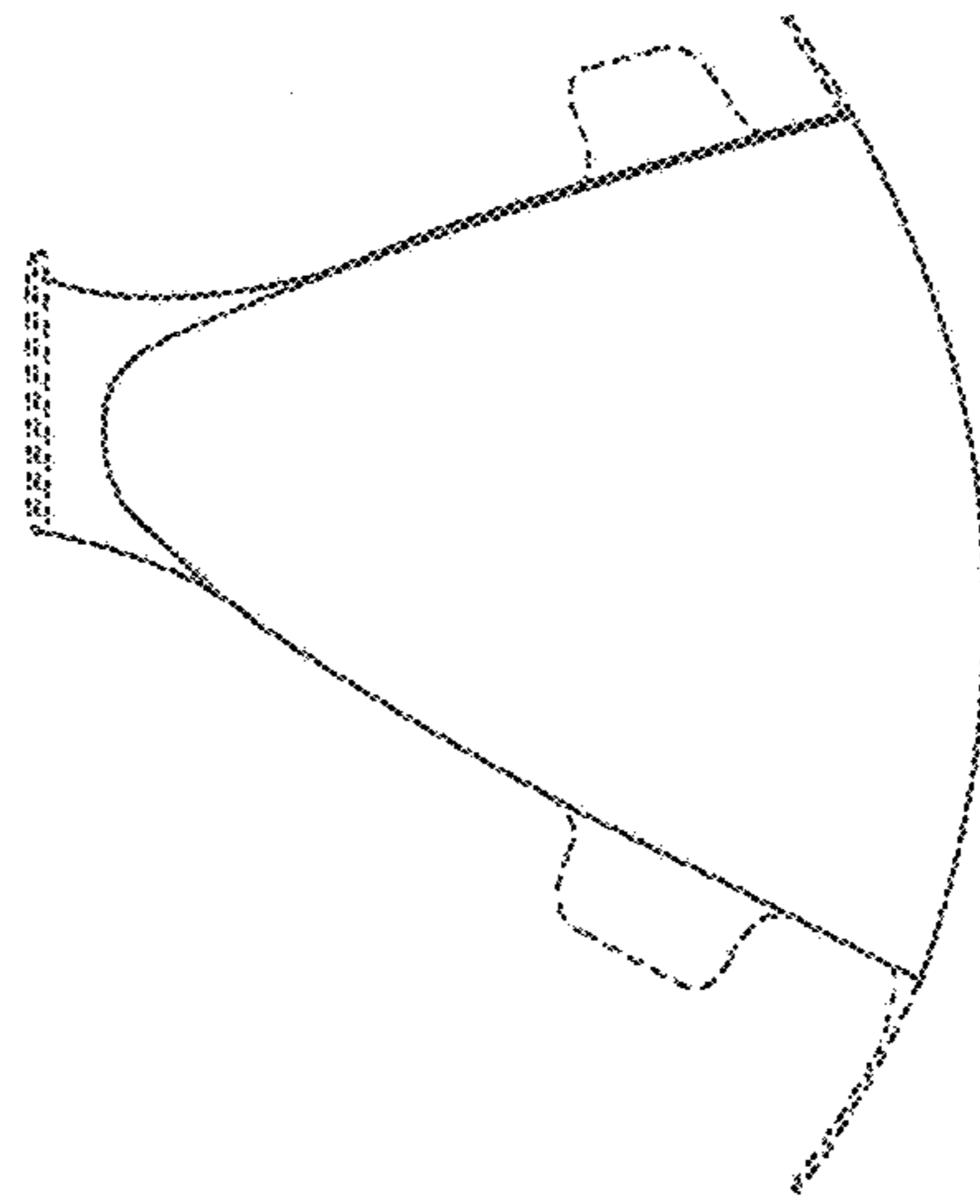

Figure 26

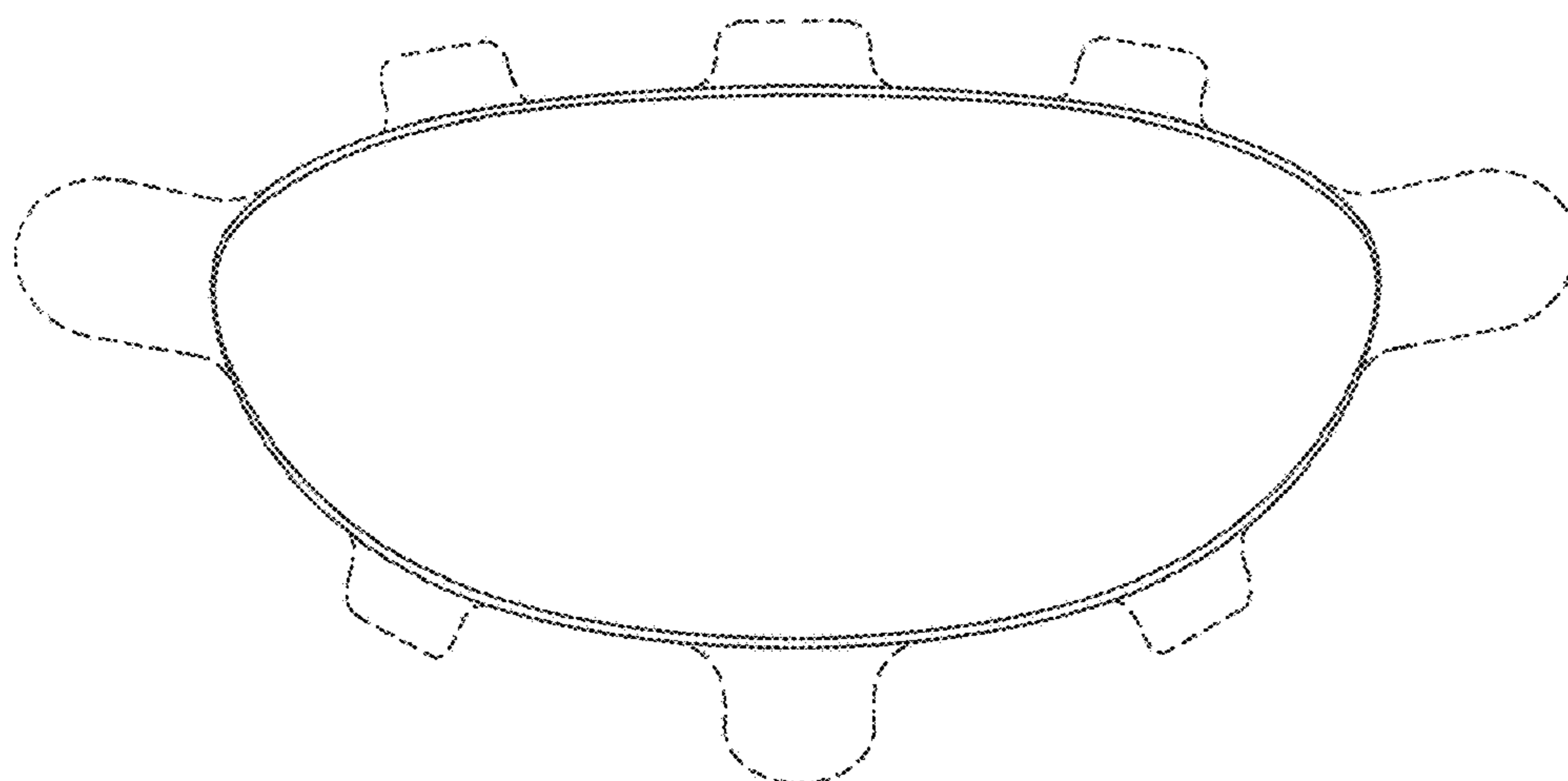

Figure 27

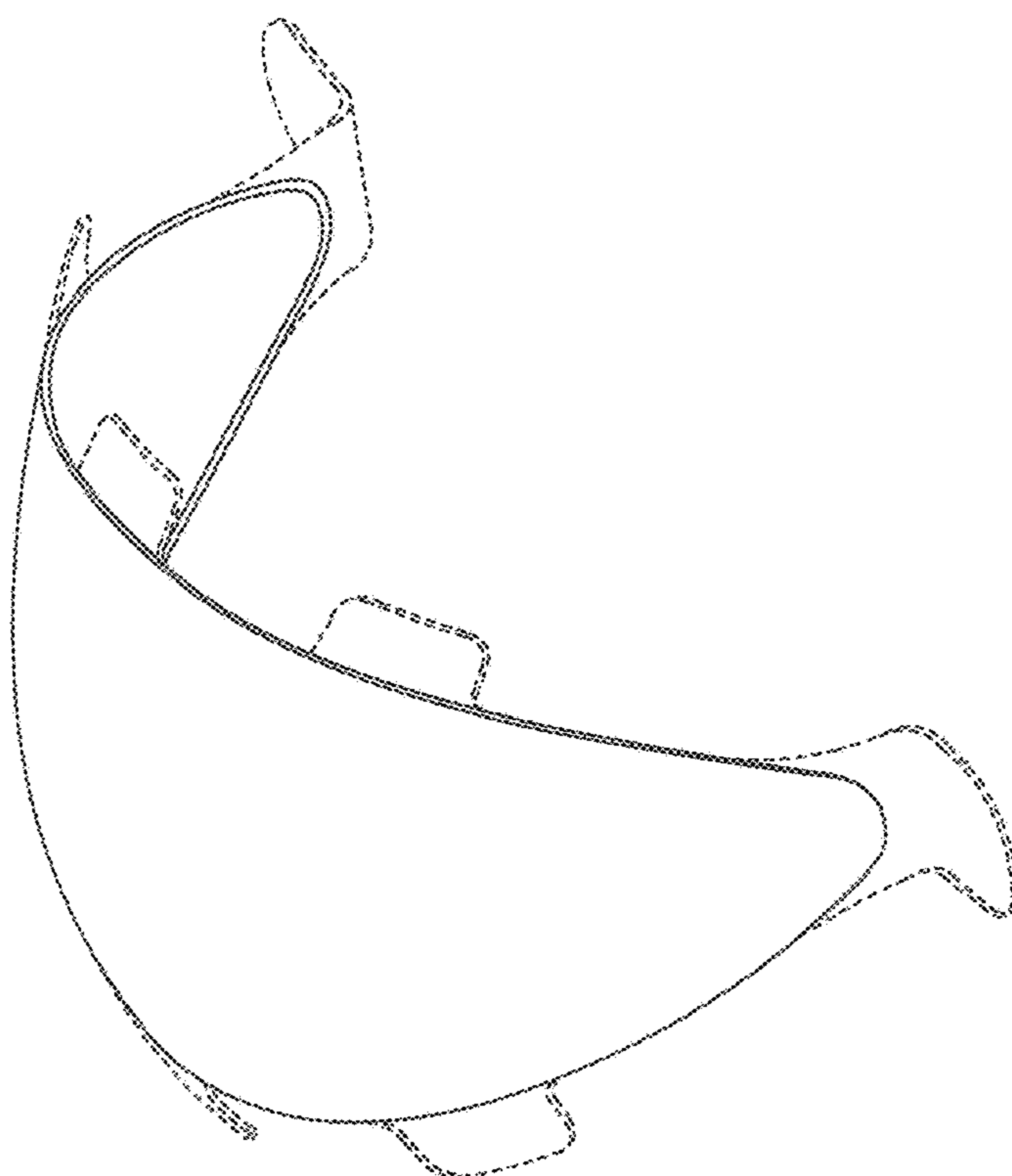

Figure 28

UNITED STATES PATENT AND TRADEMARK OFFICE
CERTIFICATE OF CORRECTION

PATENT NO. : D836,778 S
APPLICATION NO. : 29/542048
DATED : December 25, 2018
INVENTOR(S) : Limem et al.

Page 1 of 1

It is certified that error appears in the above-identified patent and that said Letters Patent is hereby corrected as shown below:

On the Title Page

In the DESCRIPTION, page 2, Column 2, cancel the text beginning with “FIG. 8 is a front view of another three dimensional mastopexy implant showing our new design;” and ending with the text “FIG. 28 is a top, front, side perspective view of the three dimensional mastopexy implant shown in FIG. 22.” at page 3, Column 1.

Under the DESCRIPTION, “1 Claim, 25 Drawing Sheets” should read --1 Claim, 7 Drawing Sheets--.

In the Drawings

Cancel figures 8-28.

Signed and Sealed this
Second Day of April, 2019

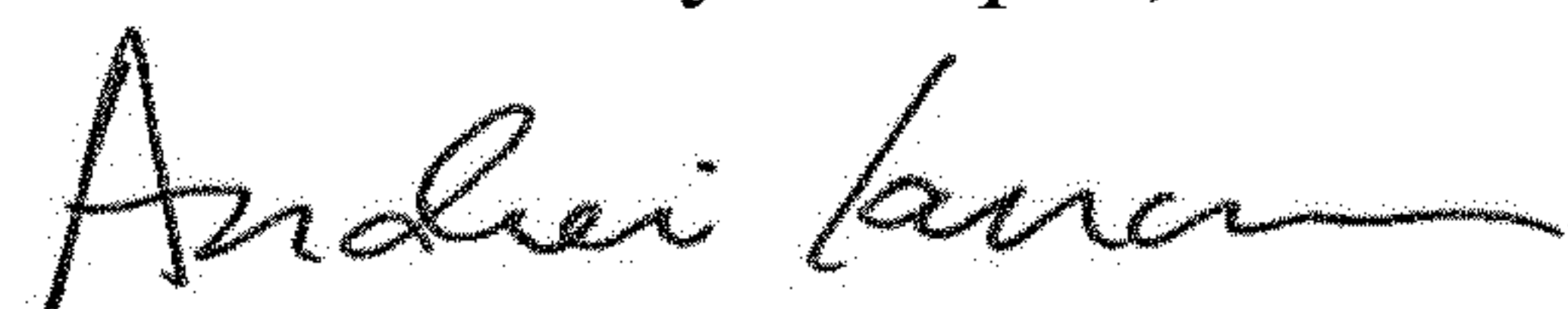

Andrei Iancu
Director of the United States Patent and Trademark Office