



US00D836716S

(12) **United States Design Patent** (10) **Patent No.:** **US D836,716 S**
Pryor (45) **Date of Patent:** **** Dec. 25, 2018**

(54) **INDEXING TAB**

(71) Applicant: **Daniel Lee Pryor**, Bothell, WA (US)

(72) Inventor: **Daniel Lee Pryor**, Bothell, WA (US)

(**) Term: **15 Years**

(21) Appl. No.: **29/622,300**

(22) Filed: **Oct. 16, 2017**

Related U.S. Application Data

(62) Division of application No. 29/594,271, filed on Feb. 16, 2017, which is a division of application No. (Continued)

(51) **LOC (11) Cl.** **19-08**

(52) **U.S. Cl.**
USPC **D19/9**

(58) **Field of Classification Search**
USPC D19/1-12, 20-34, 100;
40/124.01-124.15, 672, 661, 726, 776,
(Continued)

(56) **References Cited**

U.S. PATENT DOCUMENTS

6,001,209 A 12/1999 Papat
D588,197 S 3/2009 Lau

(Continued)

Primary Examiner — Abraham Bahta

(74) *Attorney, Agent, or Firm* — Barry L. Davison; Davis Wright Tremaine LLP

(57) **CLAIM**

The ornamental design for an indexing tab, as shown and described.

DESCRIPTION

FIG. 1 is a front perspective view of a first embodiment of an indexing tab showing my new design.

FIG. 2 is a top rear perspective view thereof.

FIG. 3 is a front elevational view thereof.

FIG. 4 is a rear elevational view thereof.

FIG. 5 is a front perspective view thereof, in partially folded configuration.

FIG. 6 is a top rear perspective view thereof, in partially folded configuration.

FIG. 7 is a front perspective view thereof, in completely folded configuration.

FIG. 8 is a top rear perspective view thereof, in completely folded configuration.

FIG. 9 is a front elevational view thereof, in completely folded configuration.

FIG. 10 is a rear elevational view thereof, in completely folded configuration.

FIG. 11 is an enlargement of a portion of the view of FIG. 7.

FIG. 12 is a front perspective view of a second embodiment of an indexing tab showing my new design.

FIG. 13 is a top rear perspective view thereof.

FIG. 14 is a front elevational view thereof.

FIG. 15 is a rear elevational view thereof.

FIG. 16 is a front perspective view thereof, in partially folded configuration.

FIG. 17 is a top rear perspective view thereof, in partially folded configuration.

FIG. 18 is a front perspective view thereof, in completely folded configuration.

FIG. 19 is a top rear perspective view thereof, in completely folded configuration.

FIG. 20 is a front elevational view thereof, in completely folded configuration.

FIG. 21 is a rear elevational view thereof, in completely folded configuration.

FIG. 22 is a front perspective view of a third embodiment of an indexing tab showing my new design.

FIG. 23 is a top rear perspective view thereof.

FIG. 24 is a front elevational view thereof.

FIG. 25 is a rear elevational view thereof.

FIG. 26 is a front perspective view thereof, in partially folded configuration.

FIG. 27 is a top rear perspective view thereof, in partially folded configuration.

(Continued)

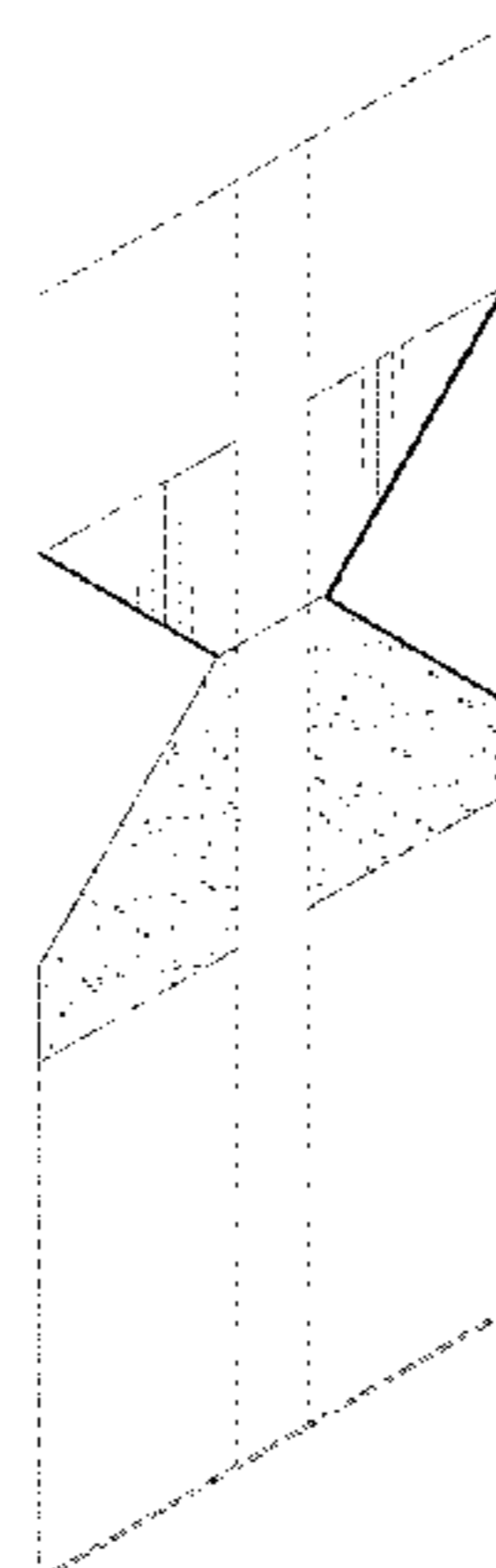
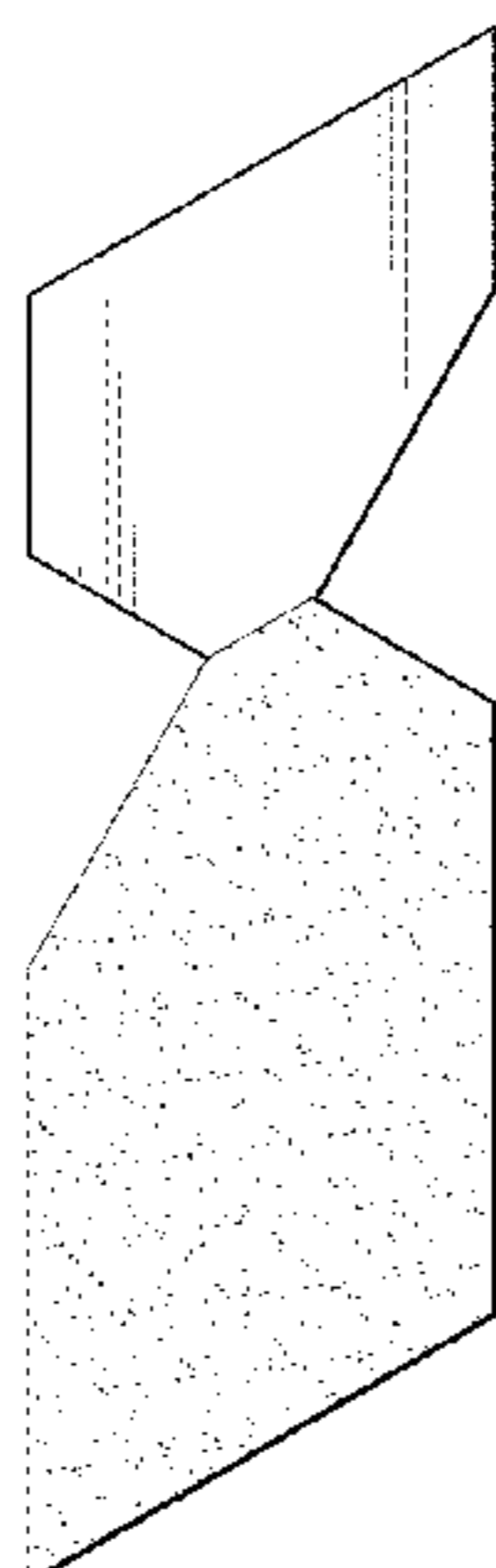

FIG. 28 is a front perspective view thereof, in completely folded configuration.

FIG. 29 is a top rear perspective view thereof, in completely folded configuration.

FIG. 30 is a front elevational view thereof, in completely folded configuration; and,

FIG. 31 is a rear elevational view thereof, in completely folded configuration.

The broken lines are for the purpose of illustrating the environment of the design only and form no part of the claimed design.

The dash-dot lines represent boundaries and form no part thereof.

1 Claim, 9 Drawing Sheets

Related U.S. Application Data

29/532,372, filed on Jul. 6, 2015, now Pat. No. Des. 779,590, which is a division of application No. 29/459,461, filed on Jun. 28, 2013, now Pat. No. Des. 733,797.

(58) Field of Classification Search

USPC 40/617; 283/72, 74-75, 103, 105-117, 283/82, 70, 94, 81, 907; 206/449; D21/385; D20/10, 22, 27, 40, 42, 11; D14/435-437; 235/380, 382, 487, 493, 235/488; D6/613, 583; 360/2

CPC B42D 15/00; B42D 15/022; B42D 15/027; B42D 15/042; B42D 15/045; B42D 25/00; B42D 25/20; B42D 25/30; B42D 25/23; B42D 25/26; B42D 25/29; B42D 25/285; B42D 2033/00; B42D 2033/02; B42D 2033/04; B42D 2033/08; B42D 2033/10; B42D 2033/18; B42D 2033/20; B42D 2033/22; B42D 2033/28; B42D 2033/30; B42F 19/00; B42F 19/02; B42F 19/04; B42F 17/00; B42F 17/04; B42F 17/06; B42F 17/12; B42F 17/34; B42F 21/00; B42F 21/02; B42F 21/06; B42F 21/12

See application file for complete search history.

(56)

References Cited

U.S. PATENT DOCUMENTS

D667,494 S	9/2012	Sato	
D679,753 S	4/2013	Sato	
D680,166 S	4/2013	Sato	
D681,110 S	4/2013	Sato	
D681,111 S	4/2013	Sato	
D690,351 S	9/2013	Sato	
D733,797 S	7/2015	Pryor	
D779,590 S	2/2017	Pryor	
D802,660 S *	11/2017	Pryor D19/1
2001/0031331 A1	10/2001	Kuo	

* cited by examiner

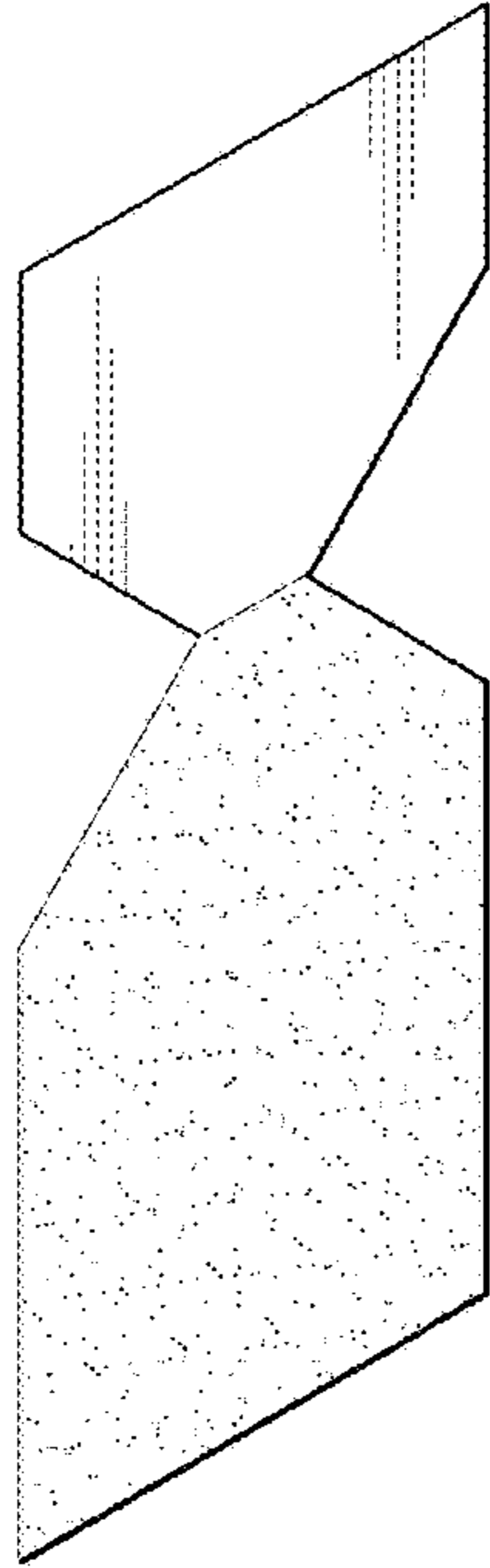

Fig. 1

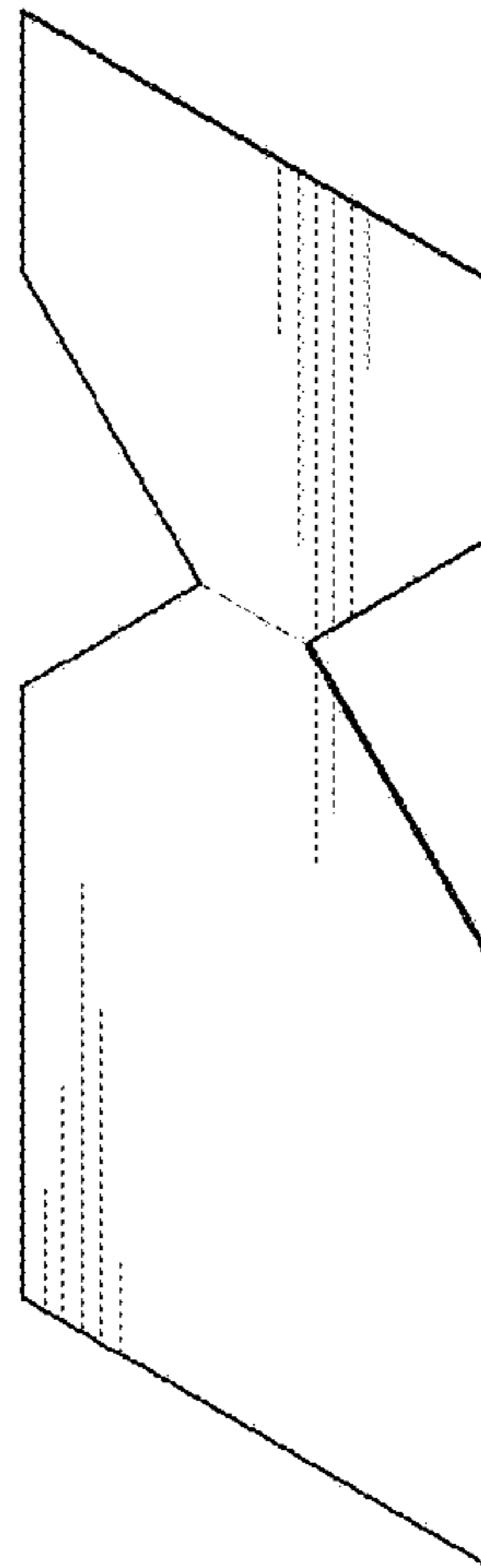

Fig. 2

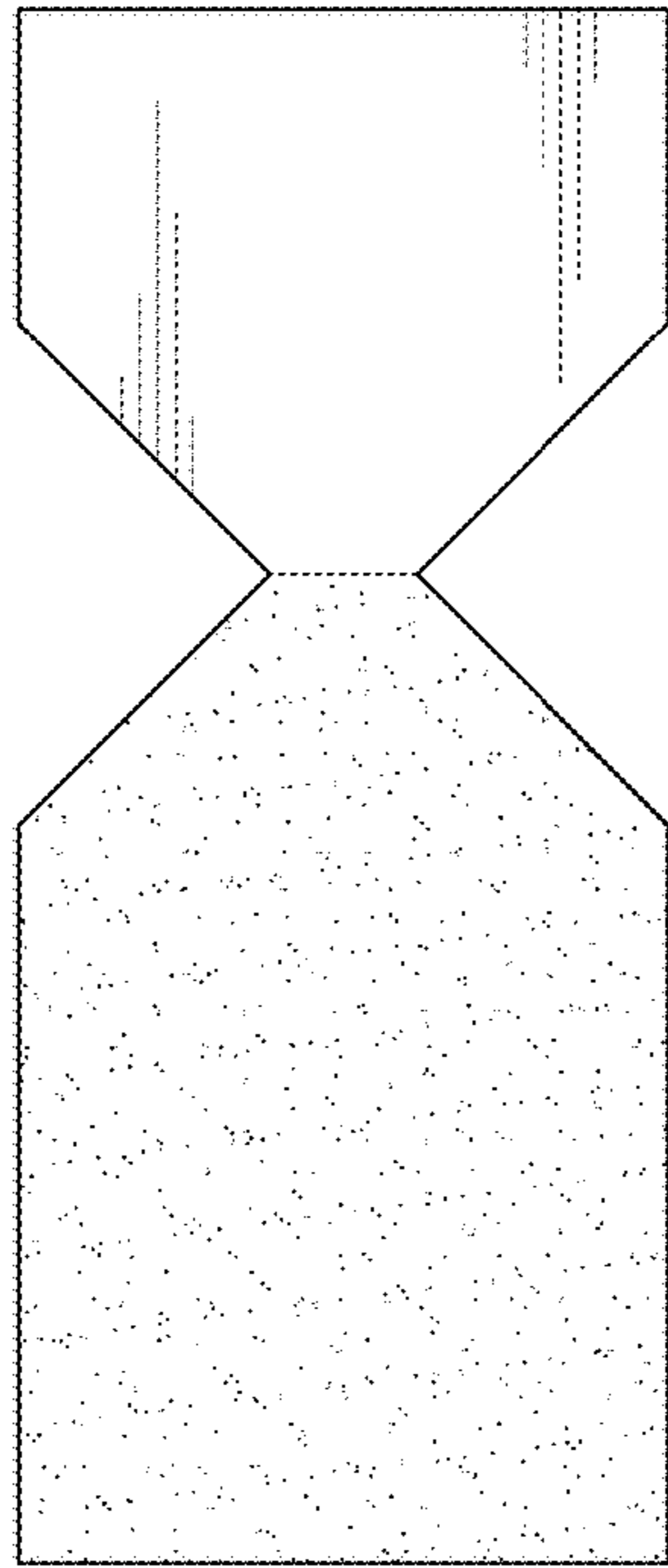

Fig. 3

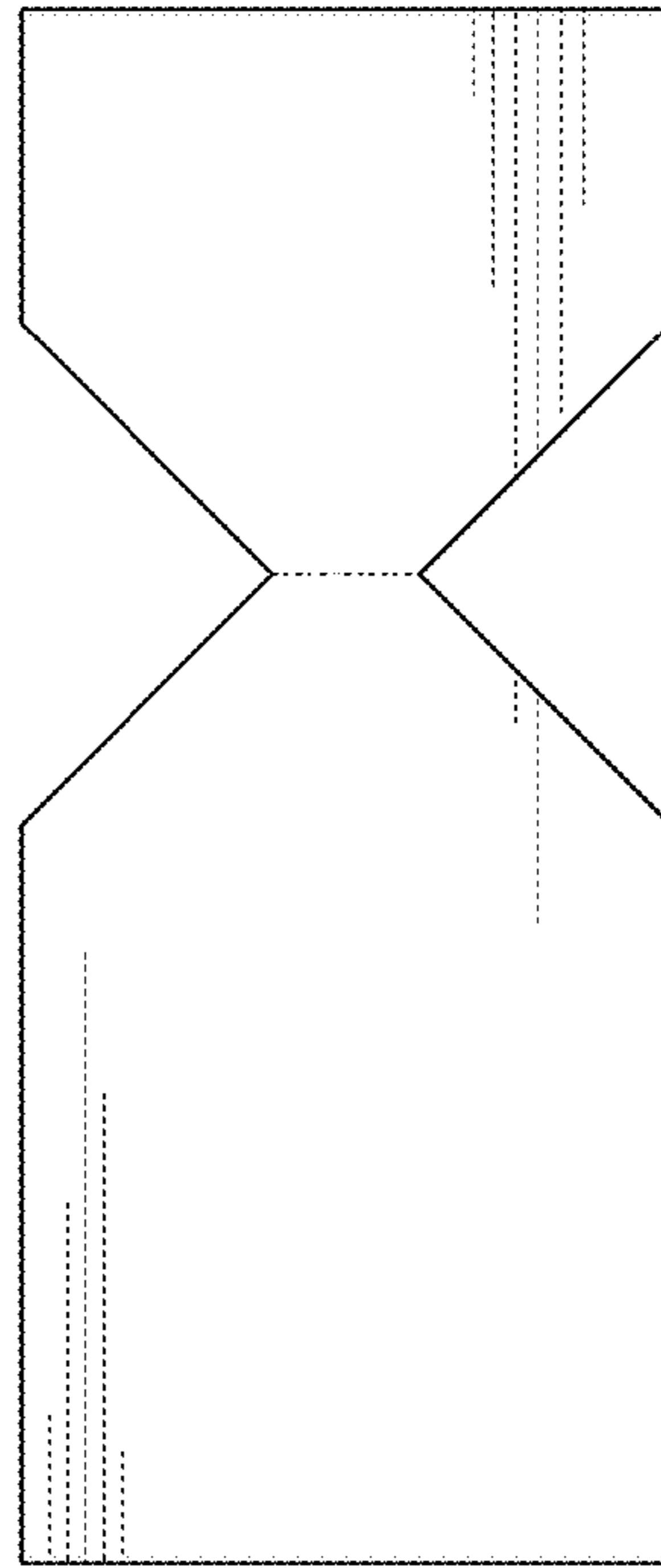

Fig. 4

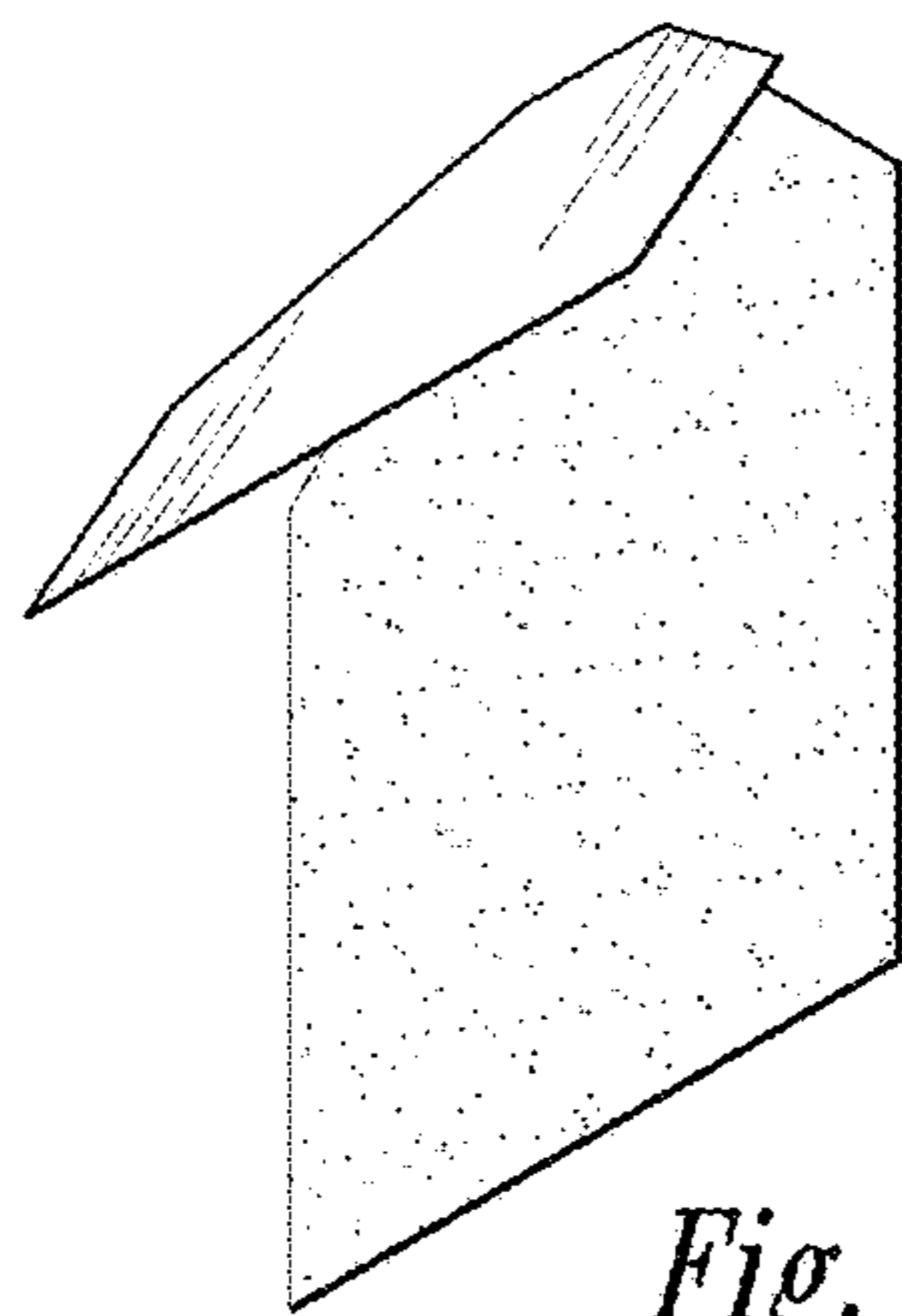

Fig. 5

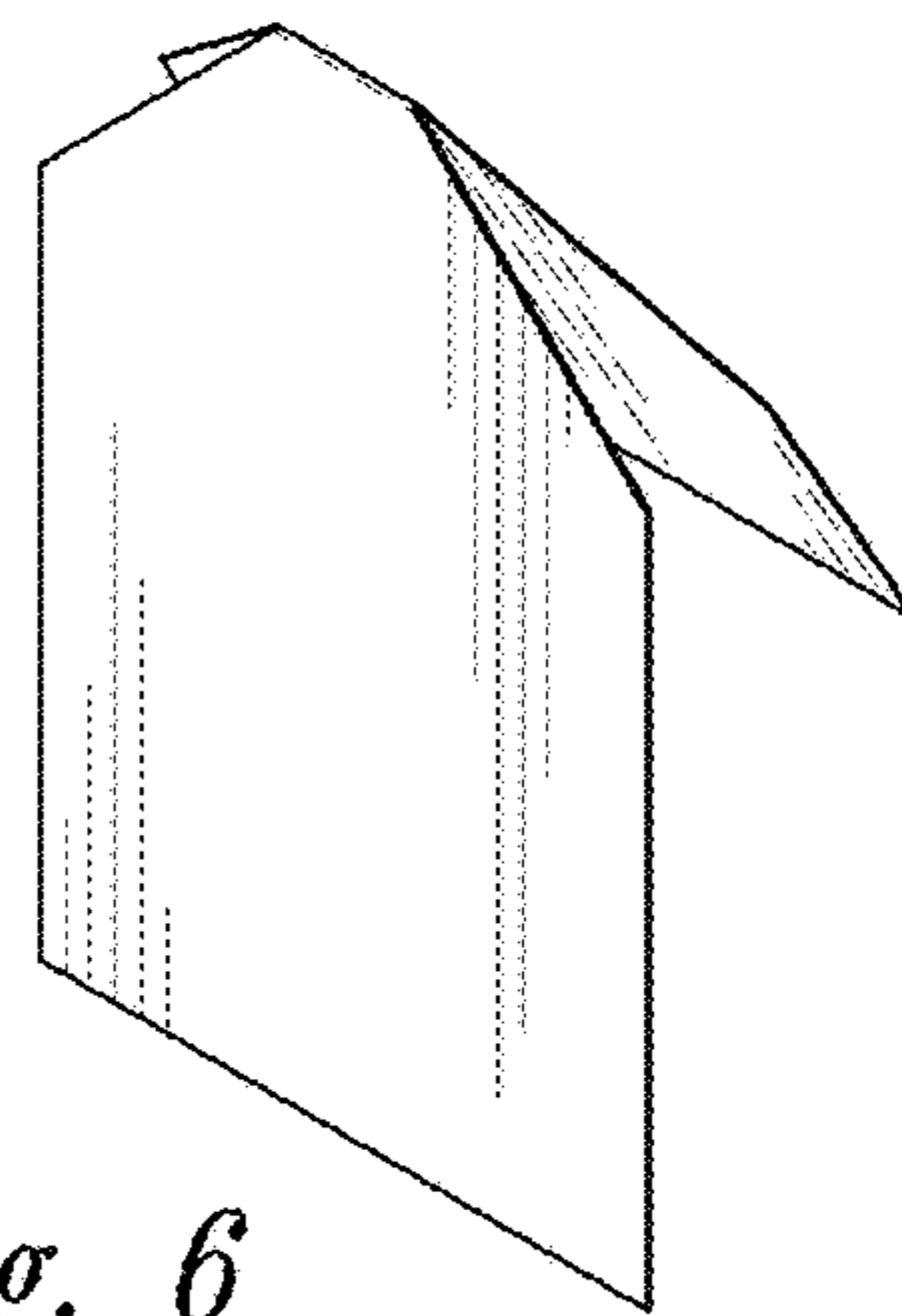

Fig. 6

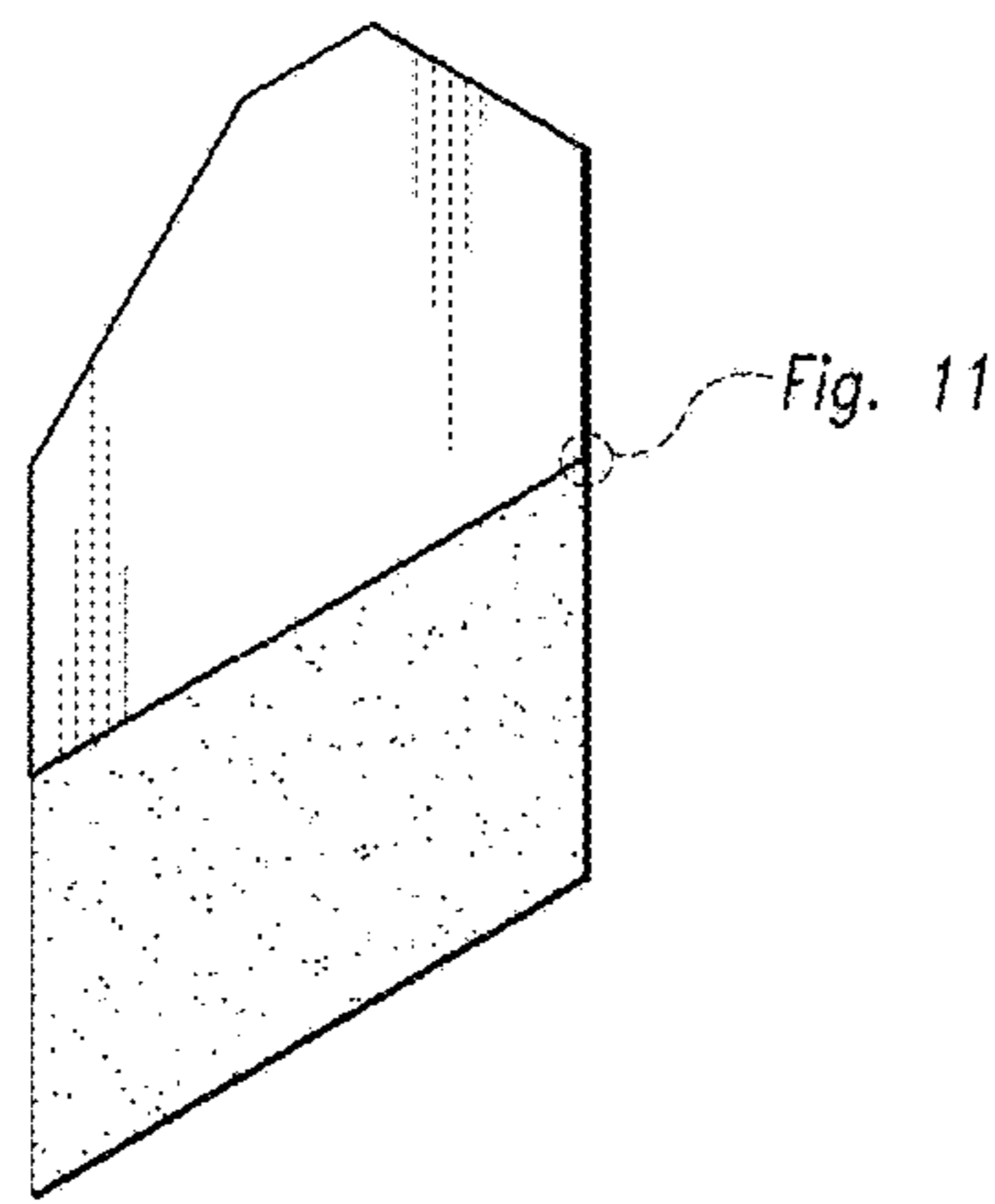

Fig. 7

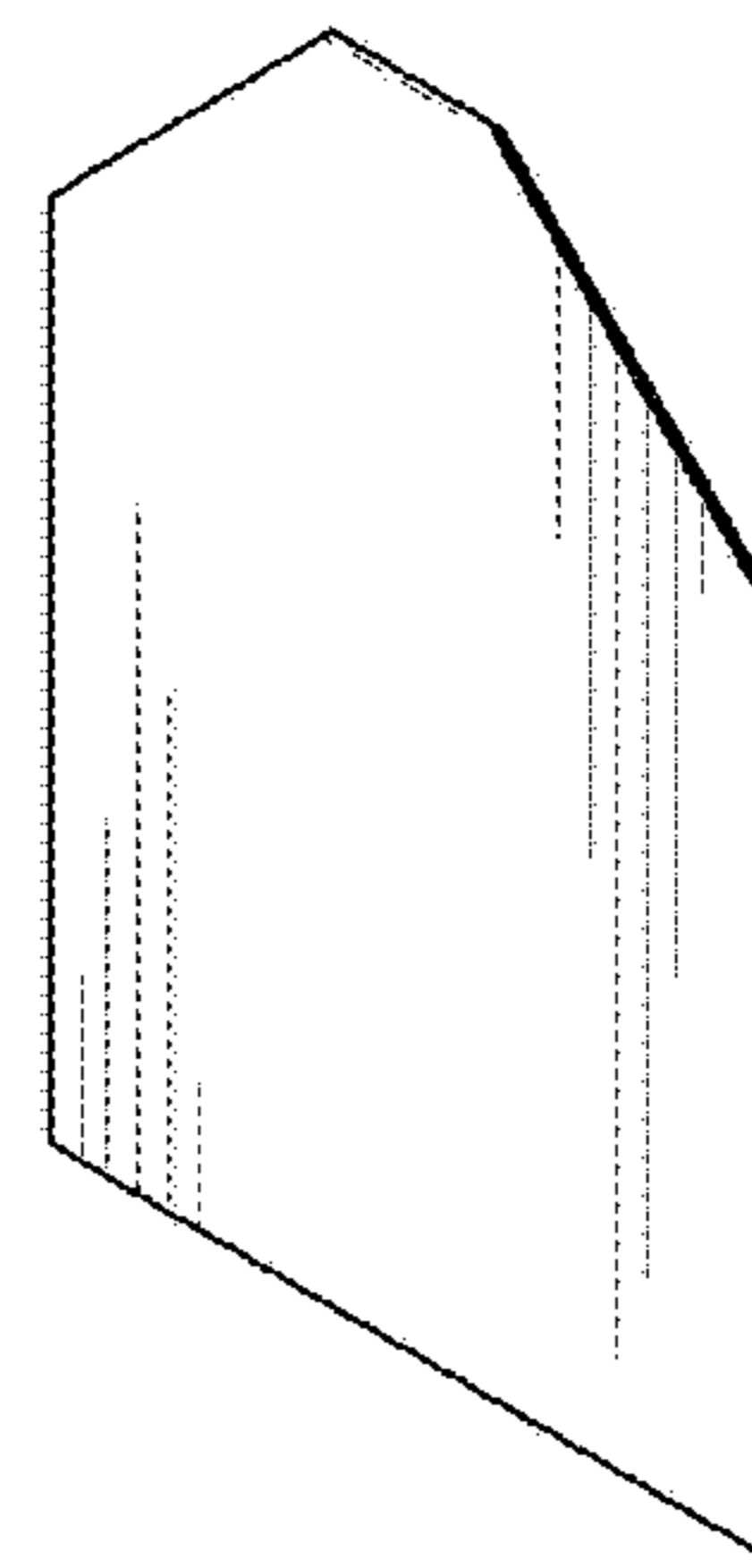

Fig. 8

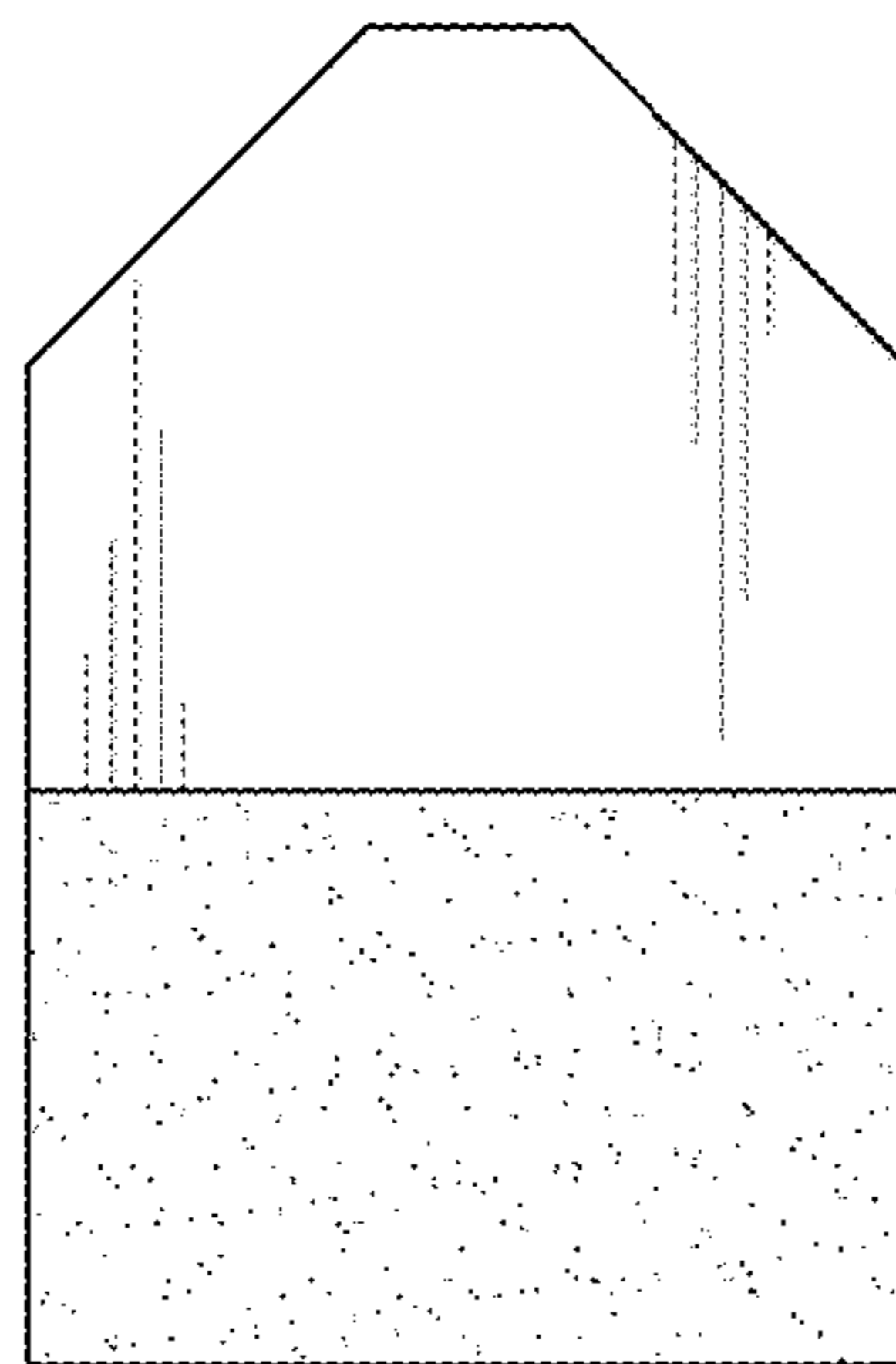

Fig. 9

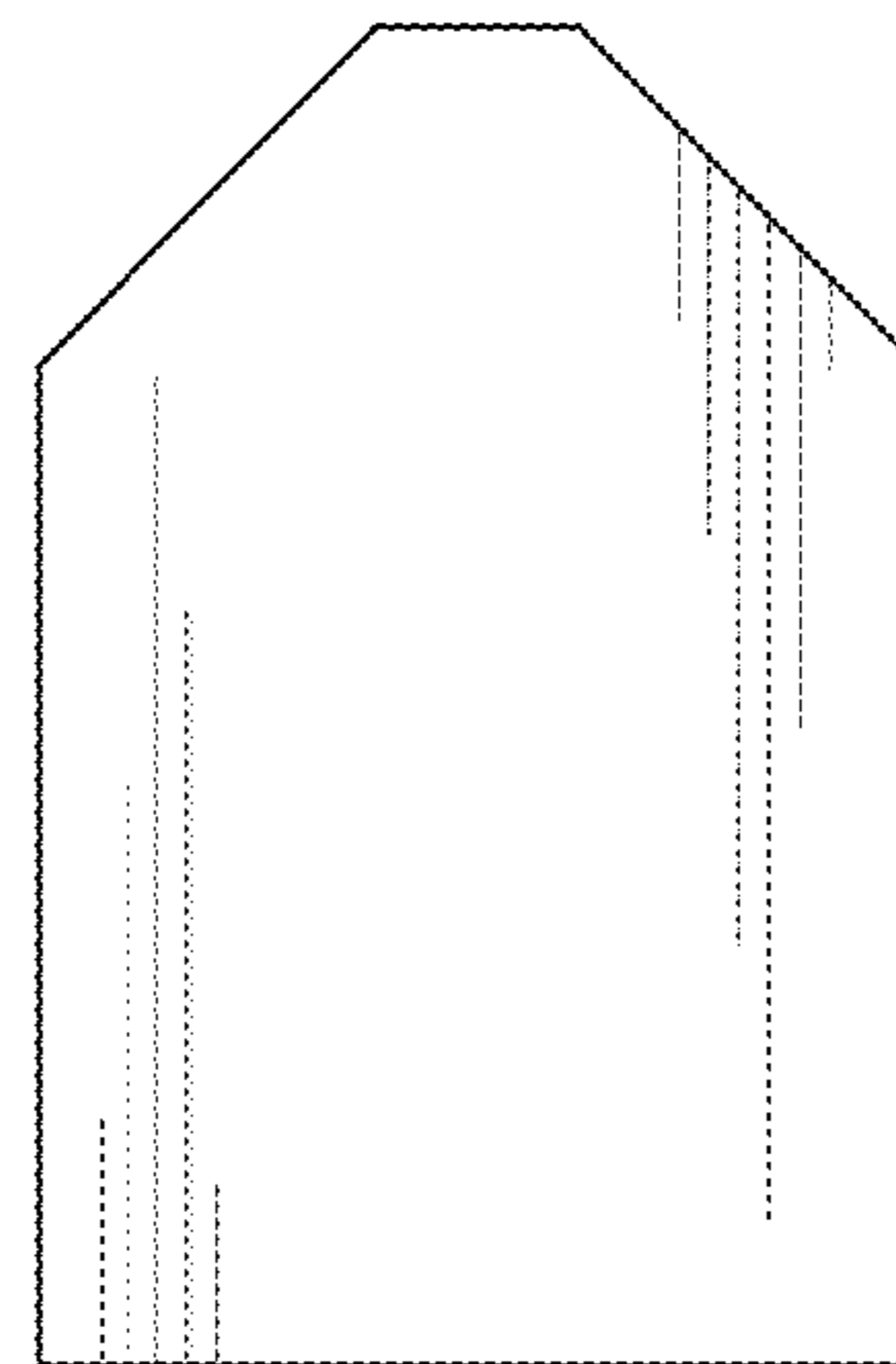

Fig. 10

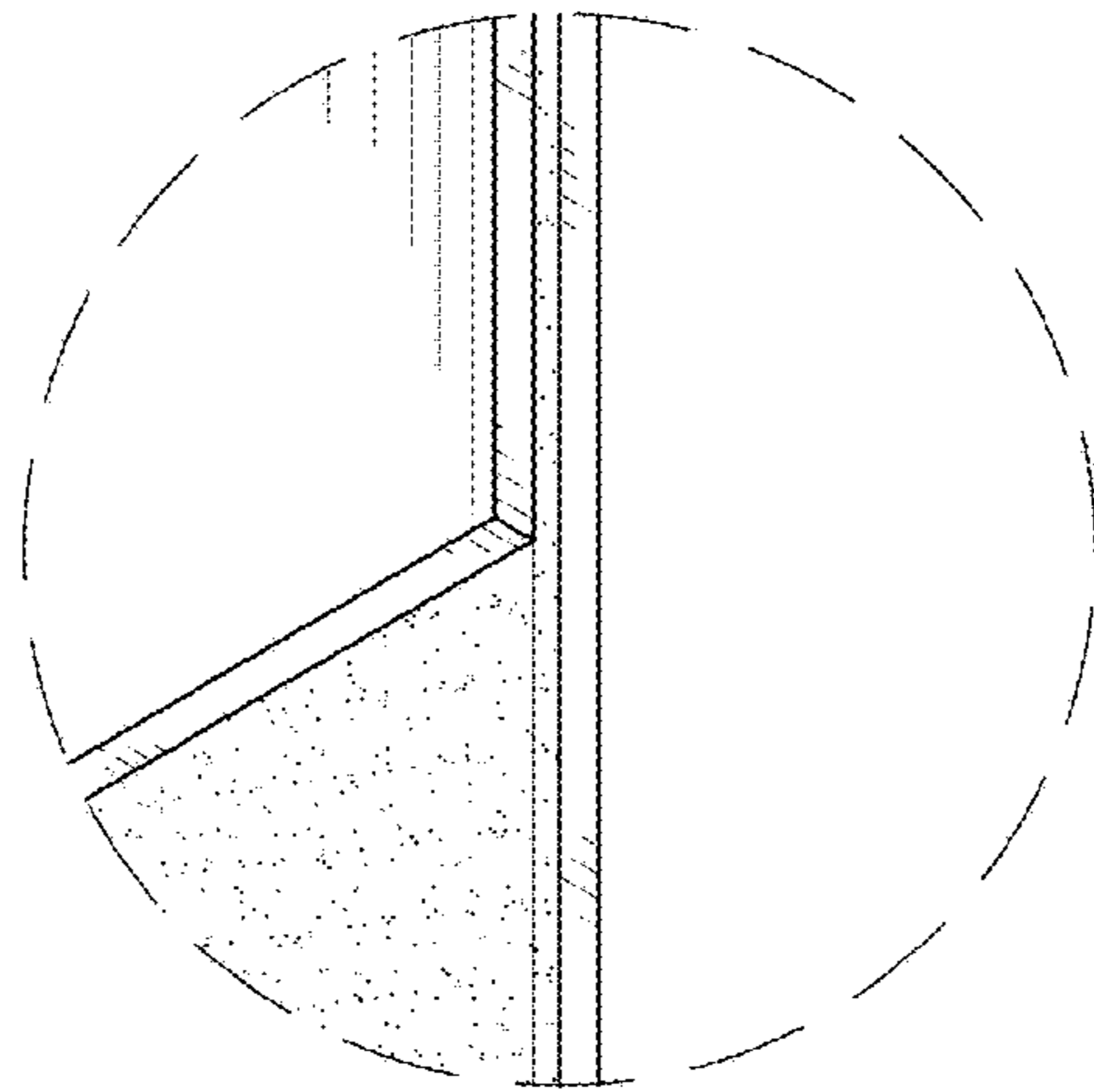

Fig. 11

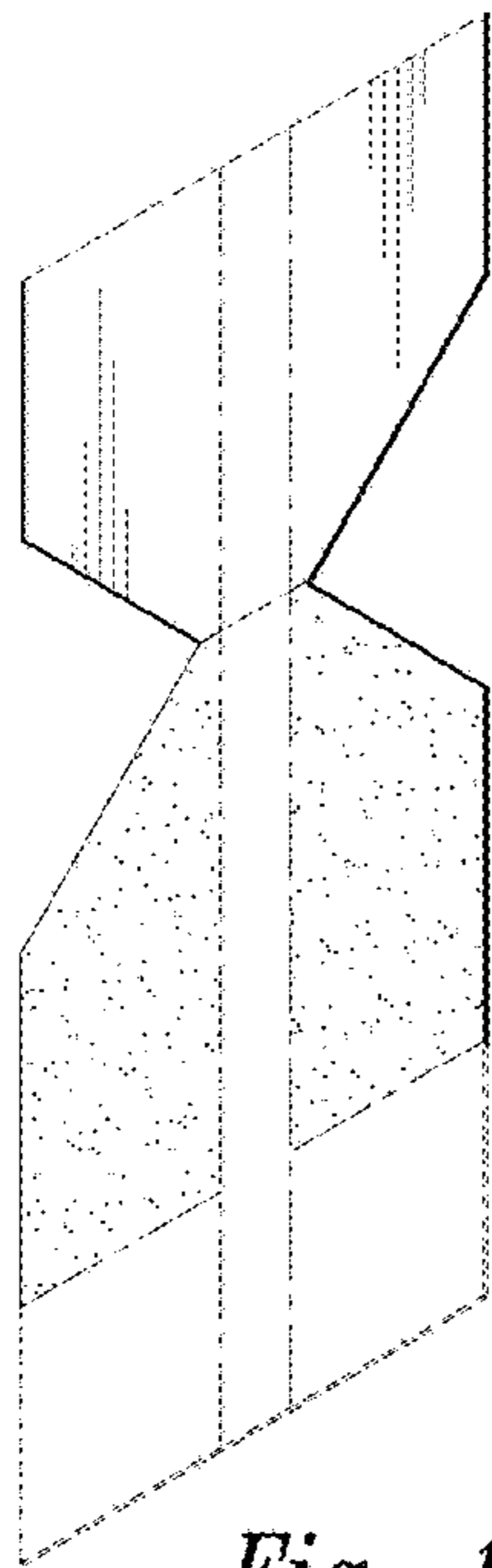

Fig. 12

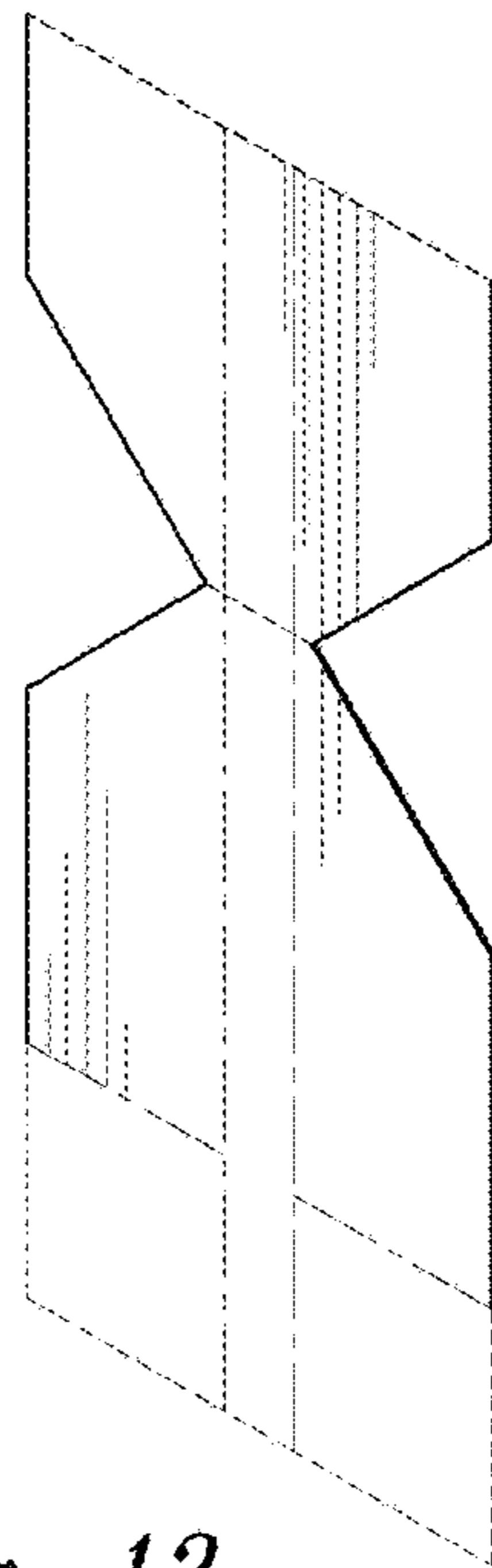

Fig. 13

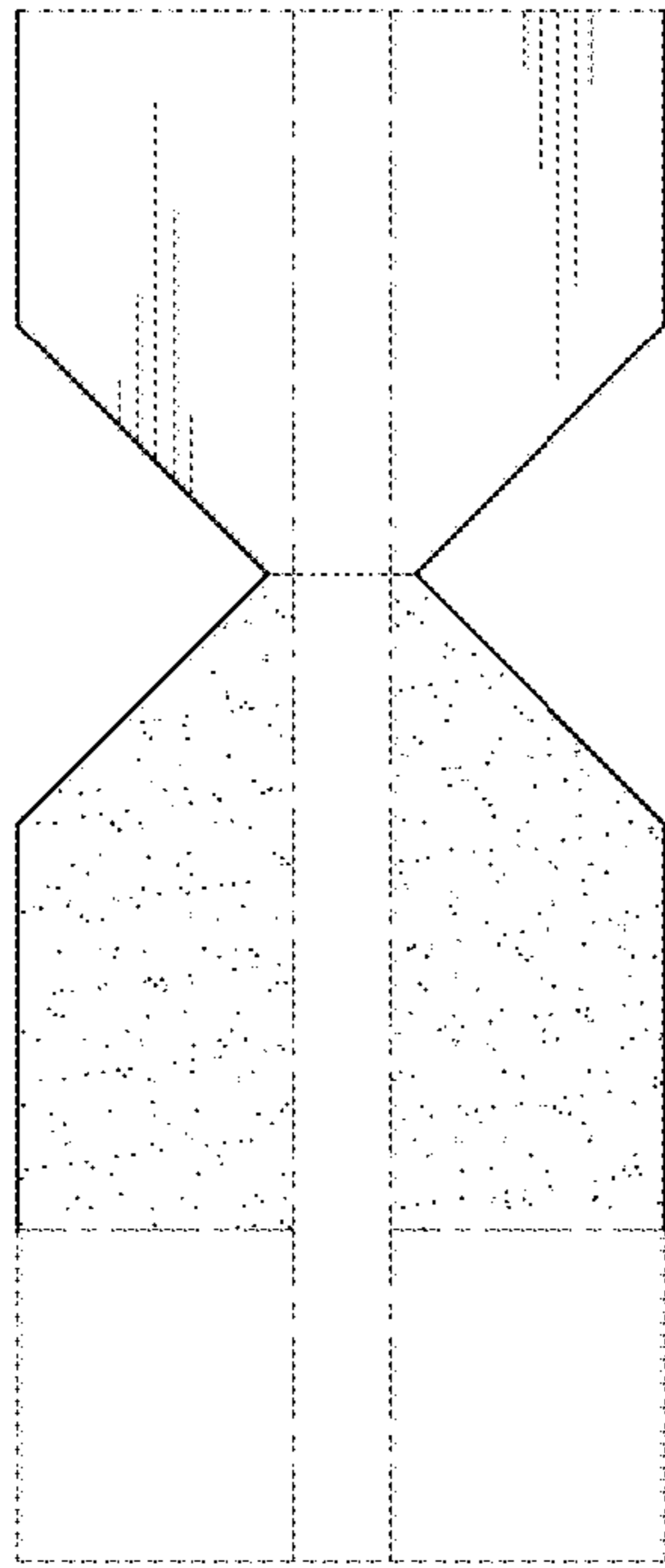

Fig. 14

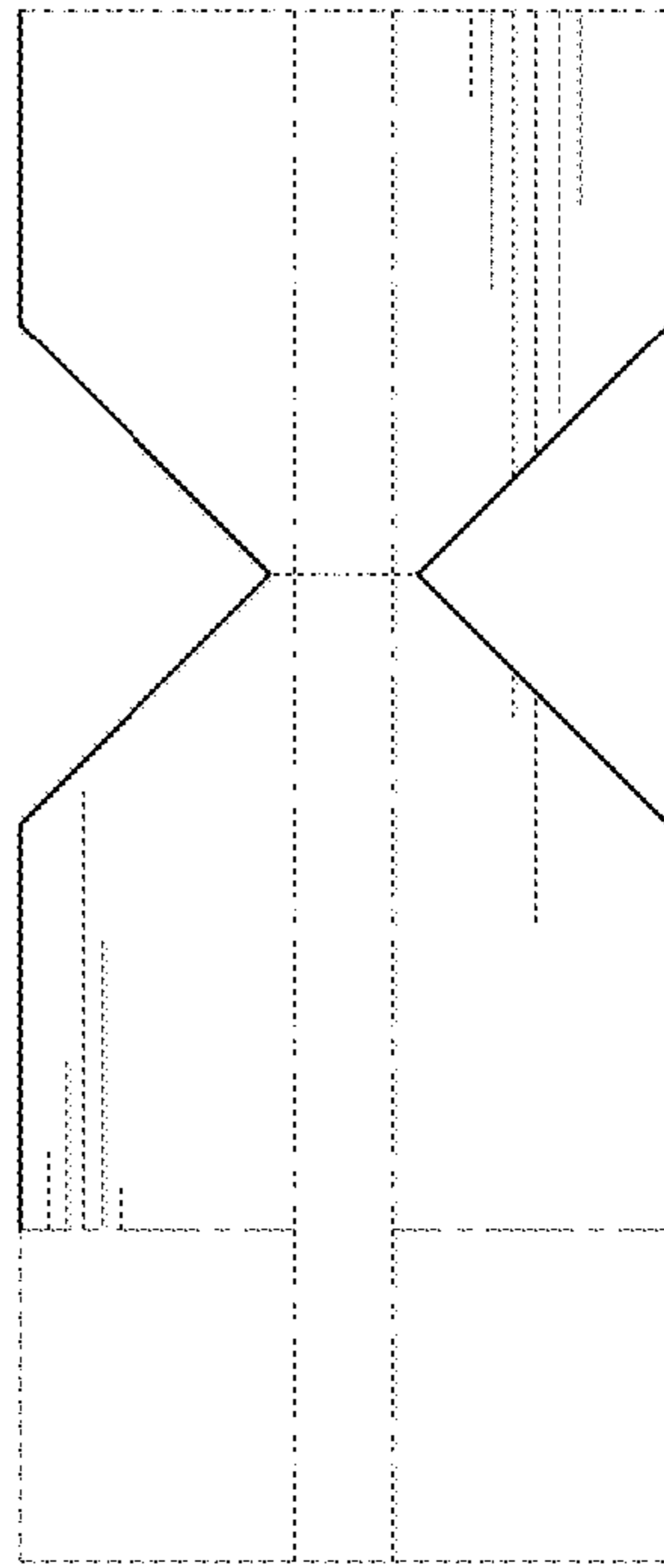

Fig. 15

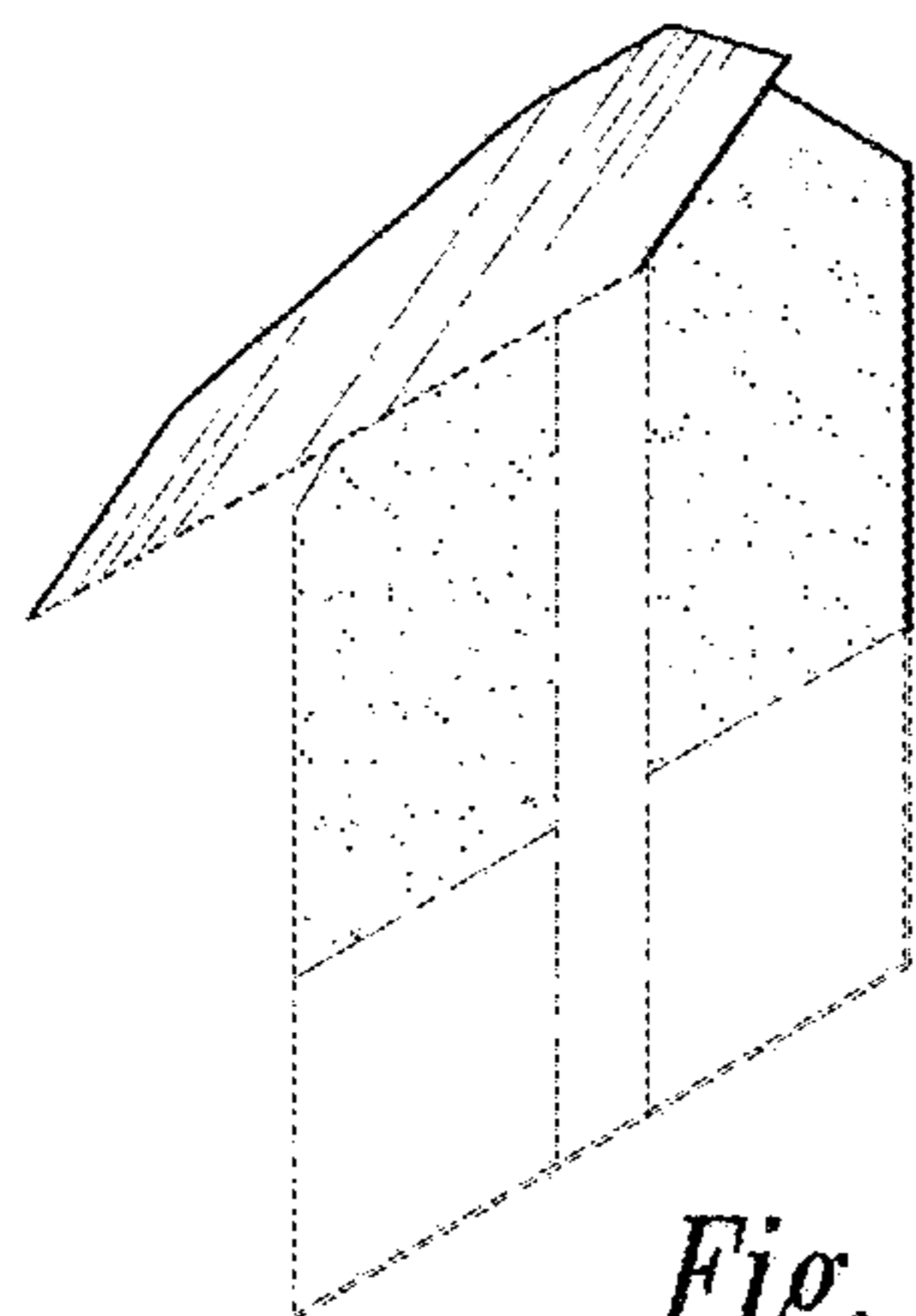

Fig. 16

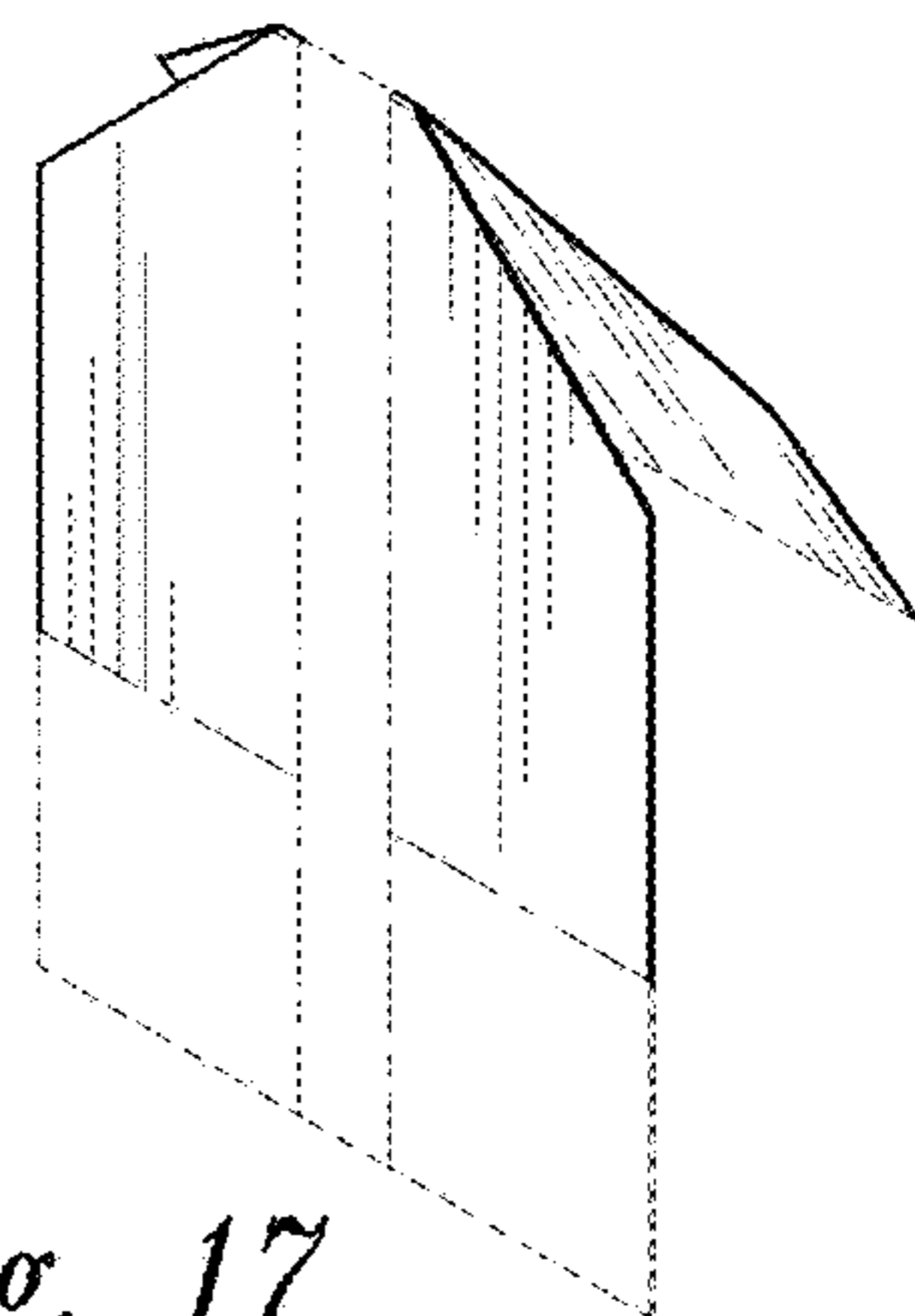

Fig. 17

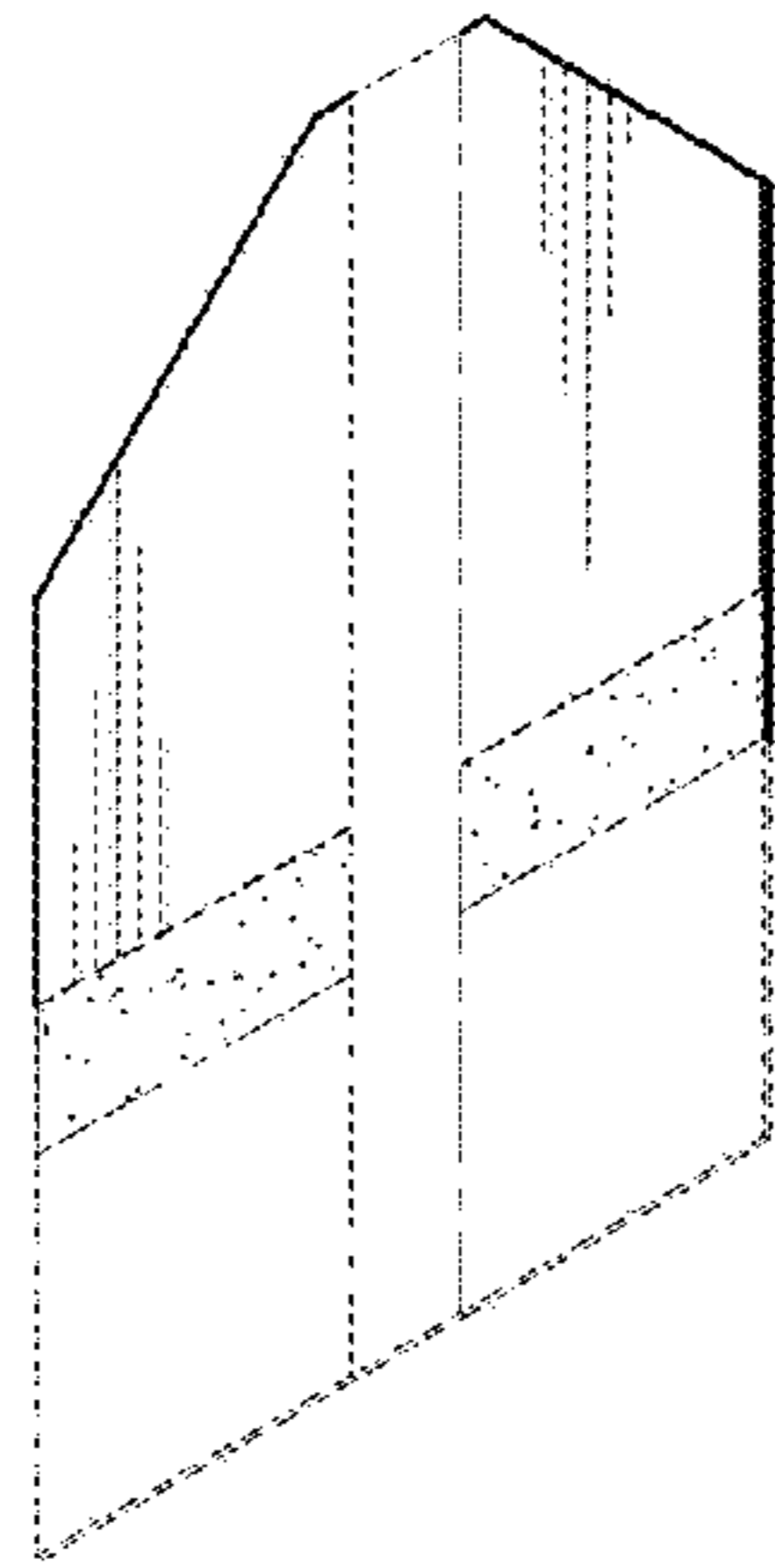

Fig. 18

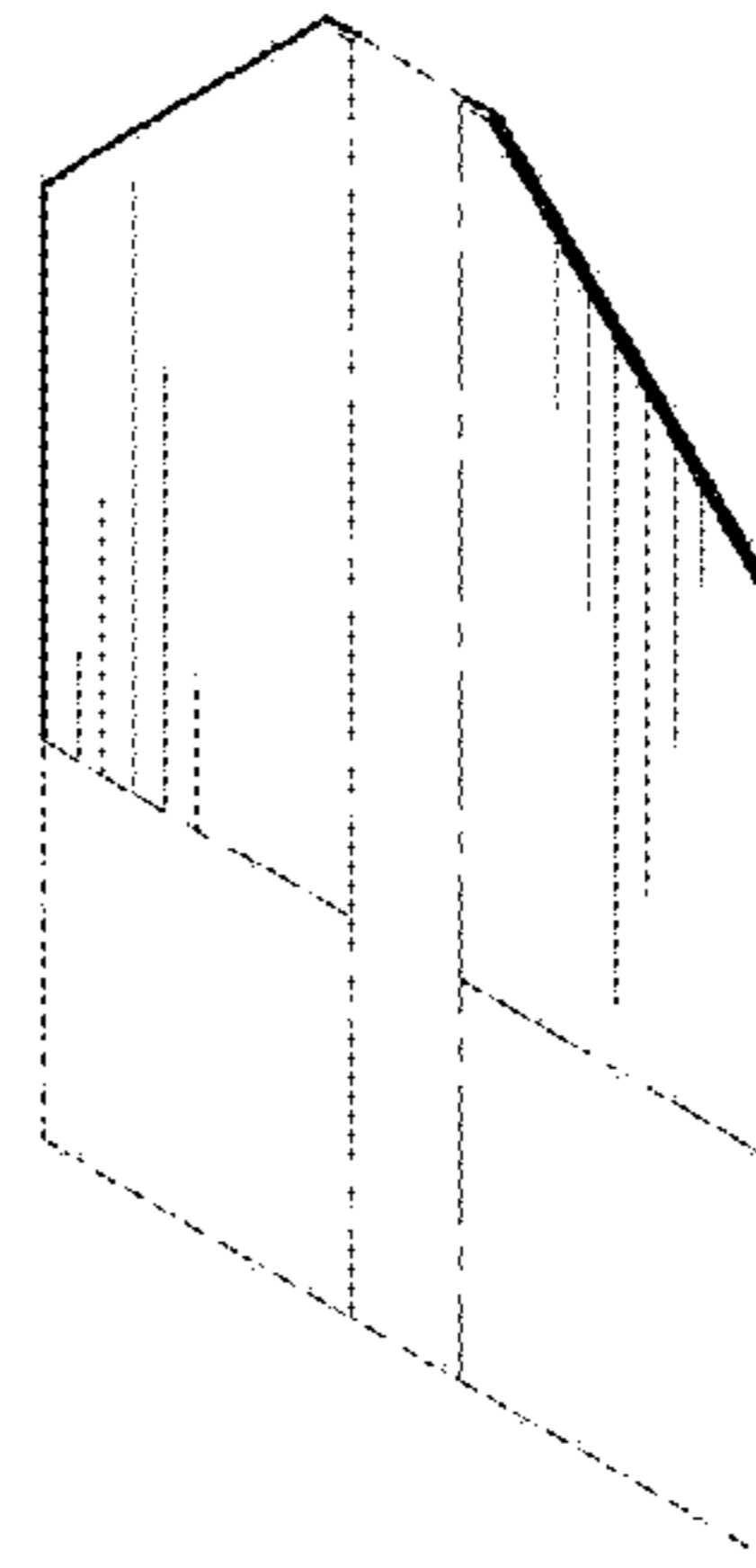

Fig. 19

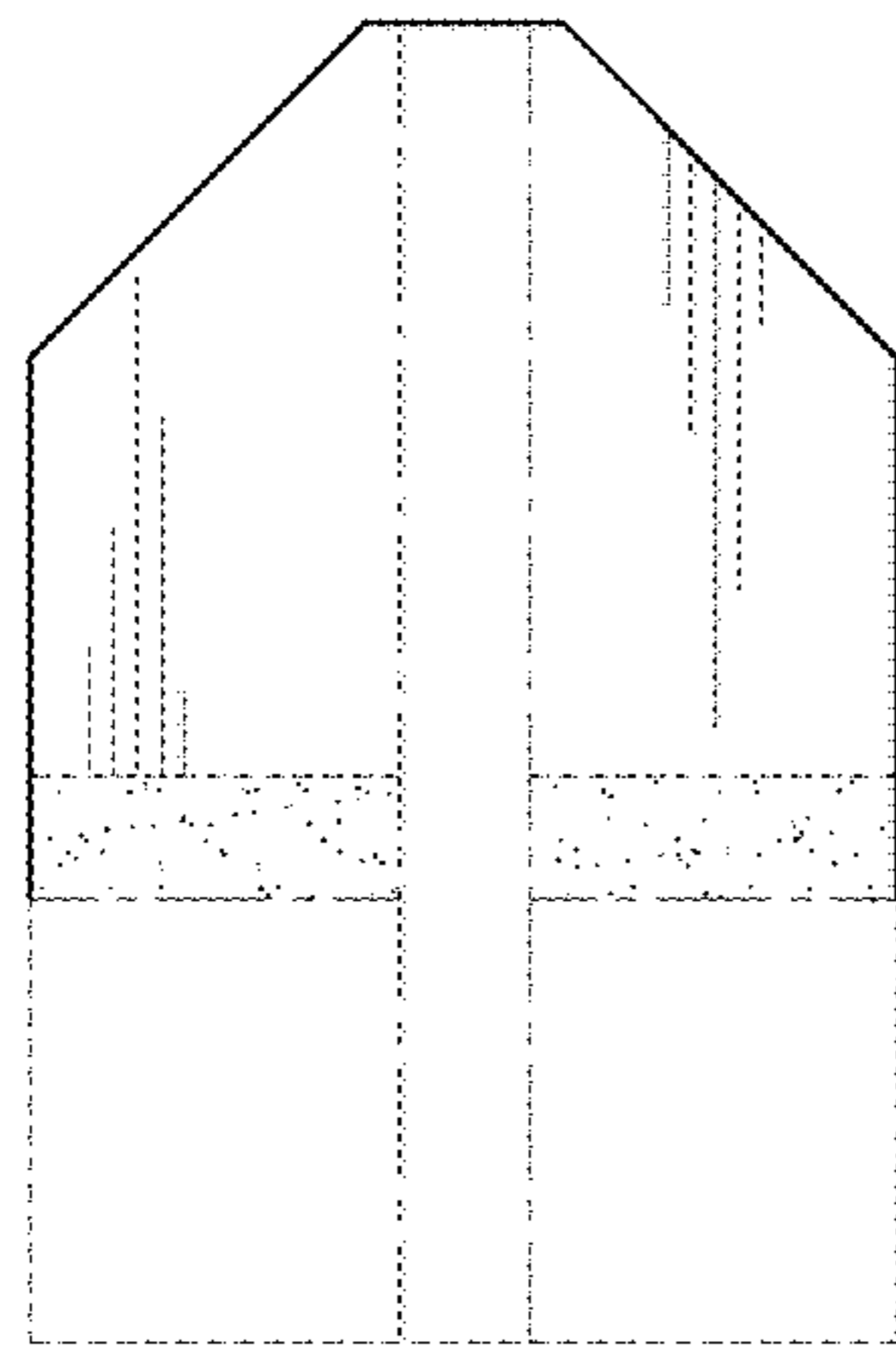

Fig. 20

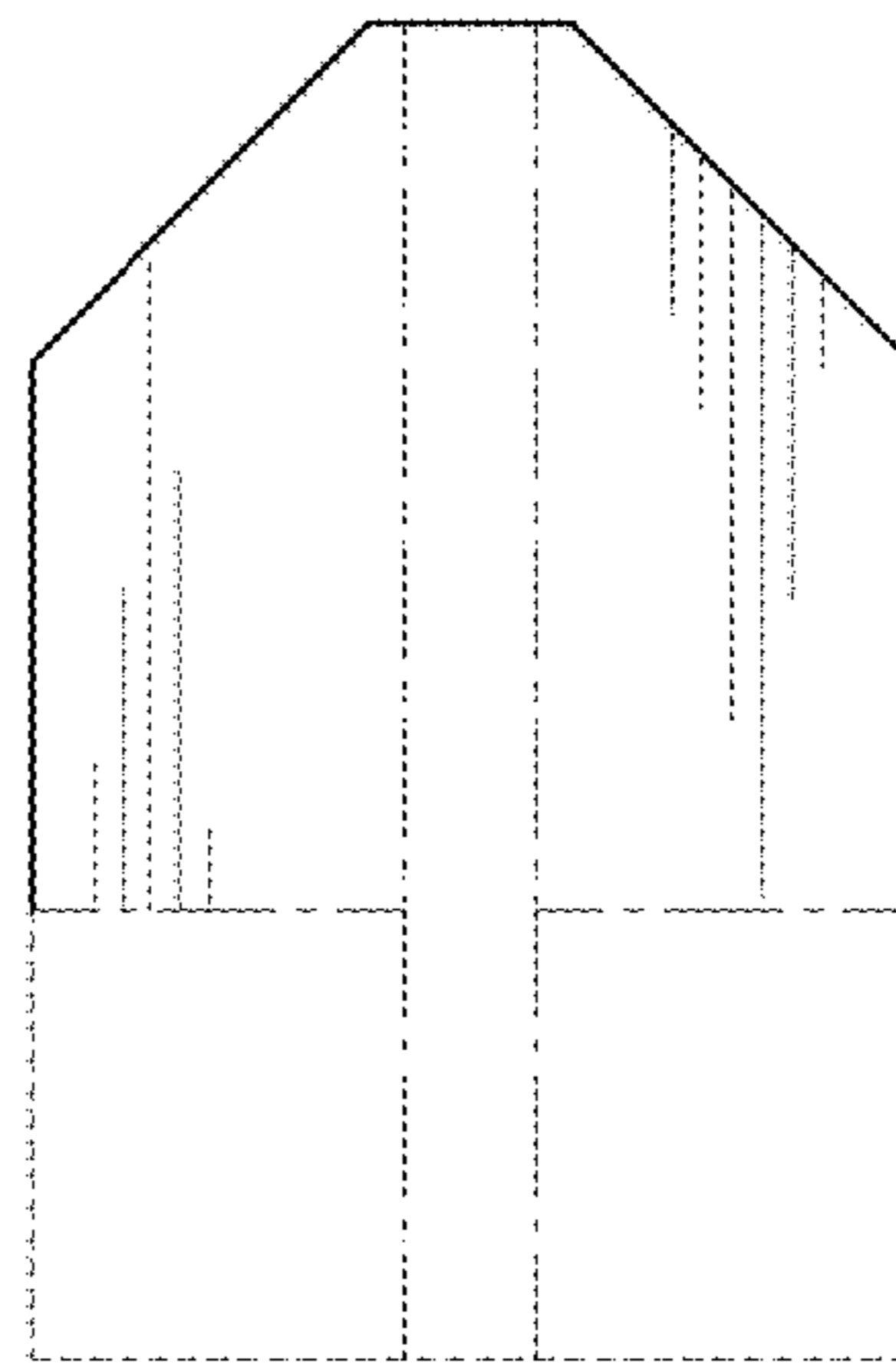

Fig. 21

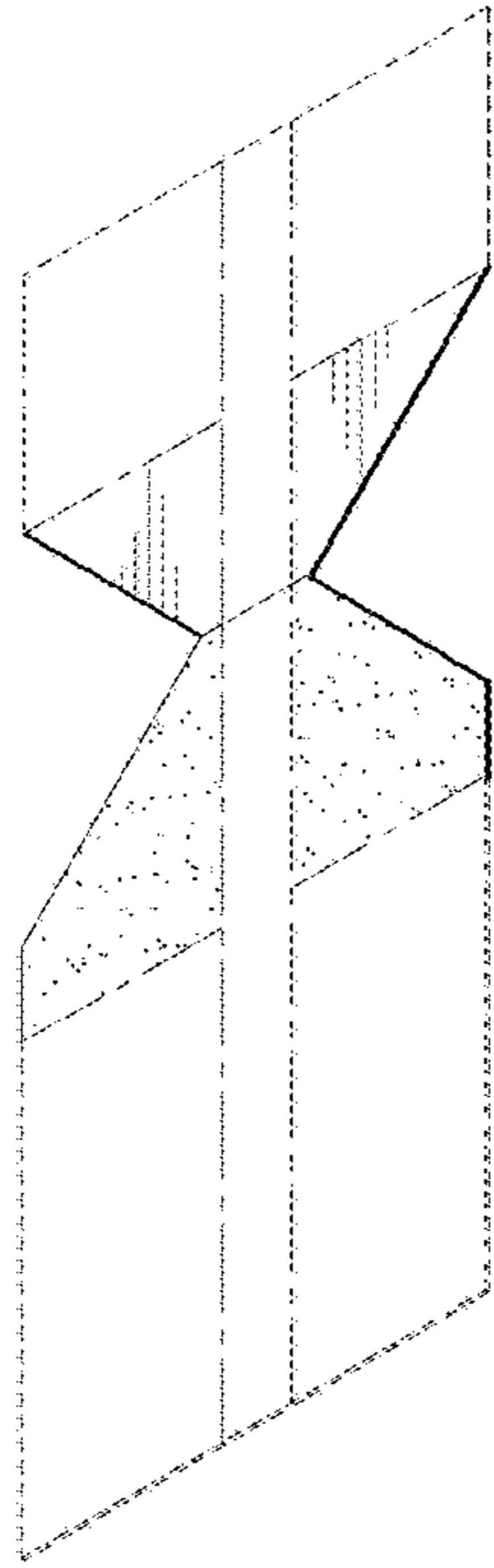

Fig. 22

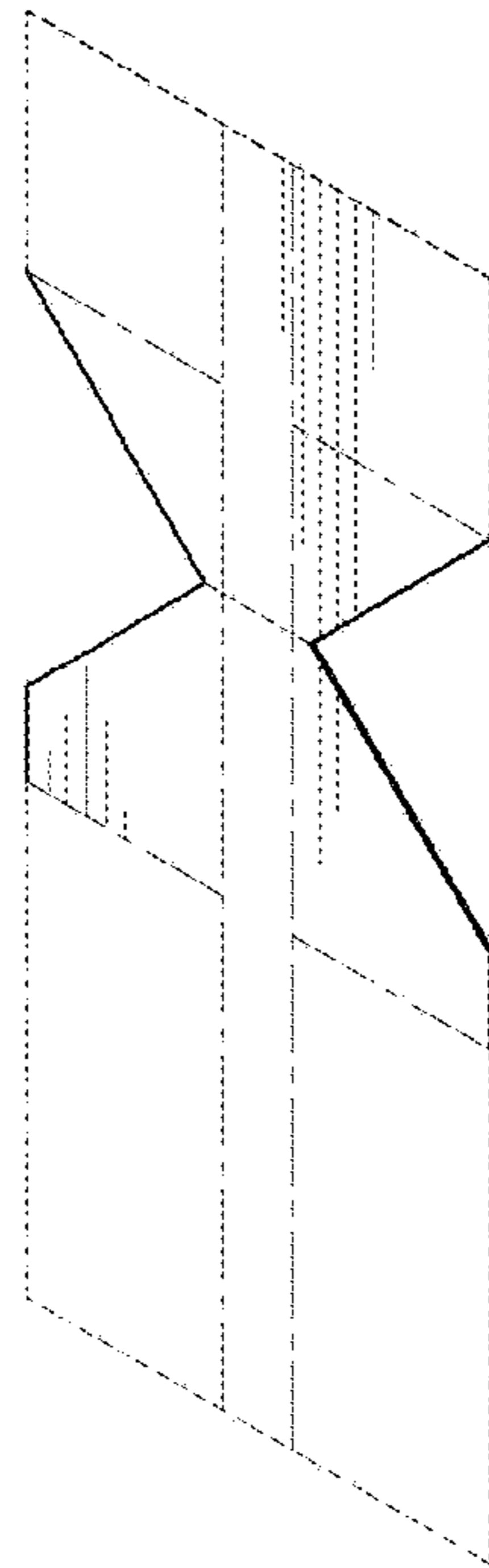

Fig. 23

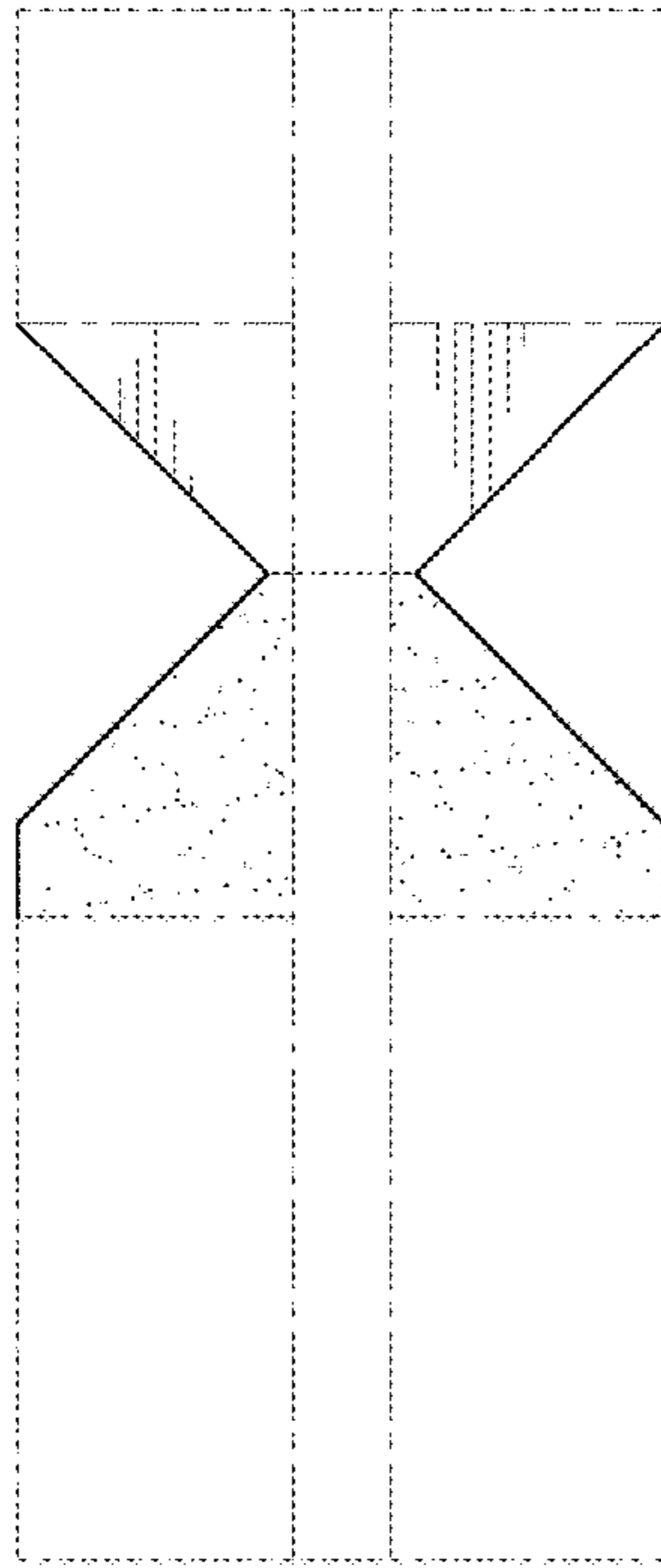

Fig. 24

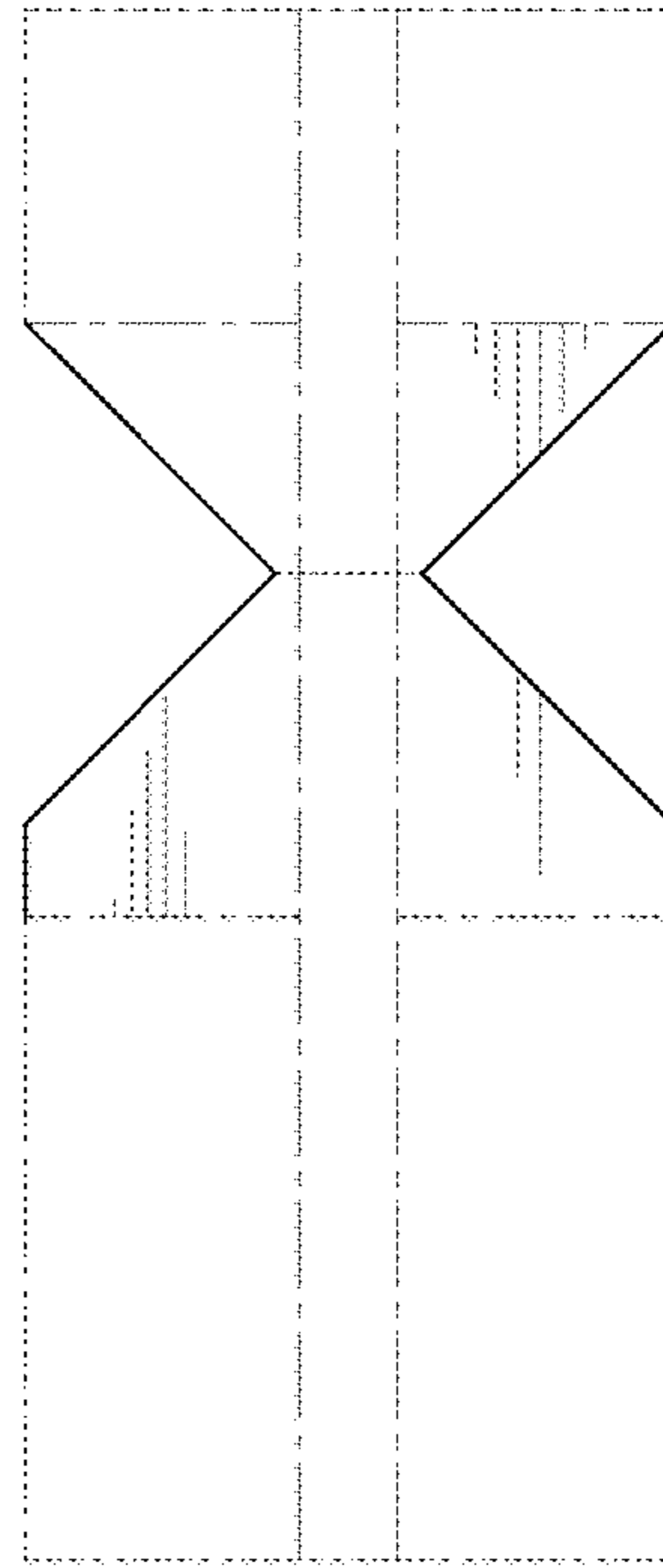

Fig. 25

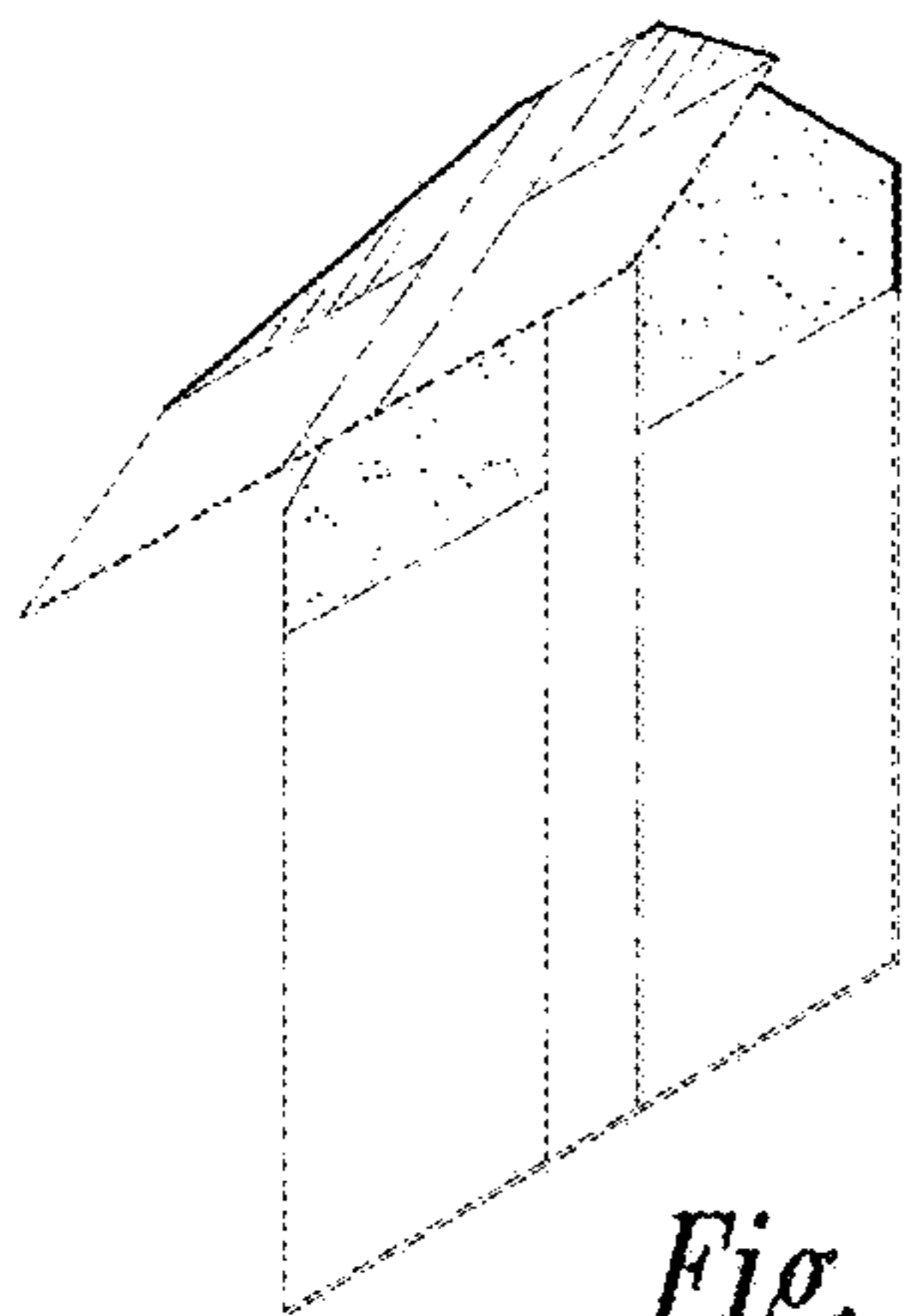

Fig. 26

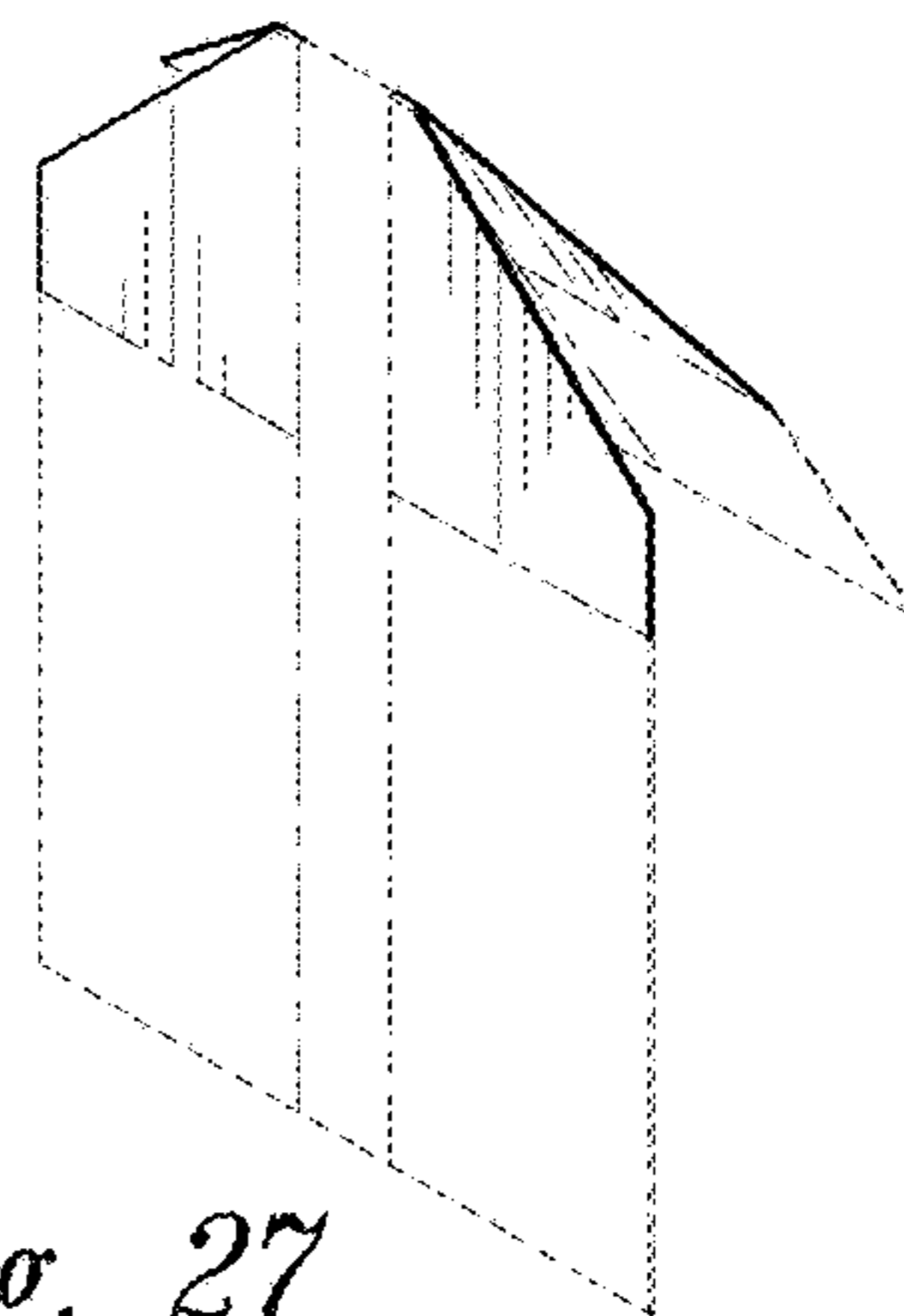

Fig. 27

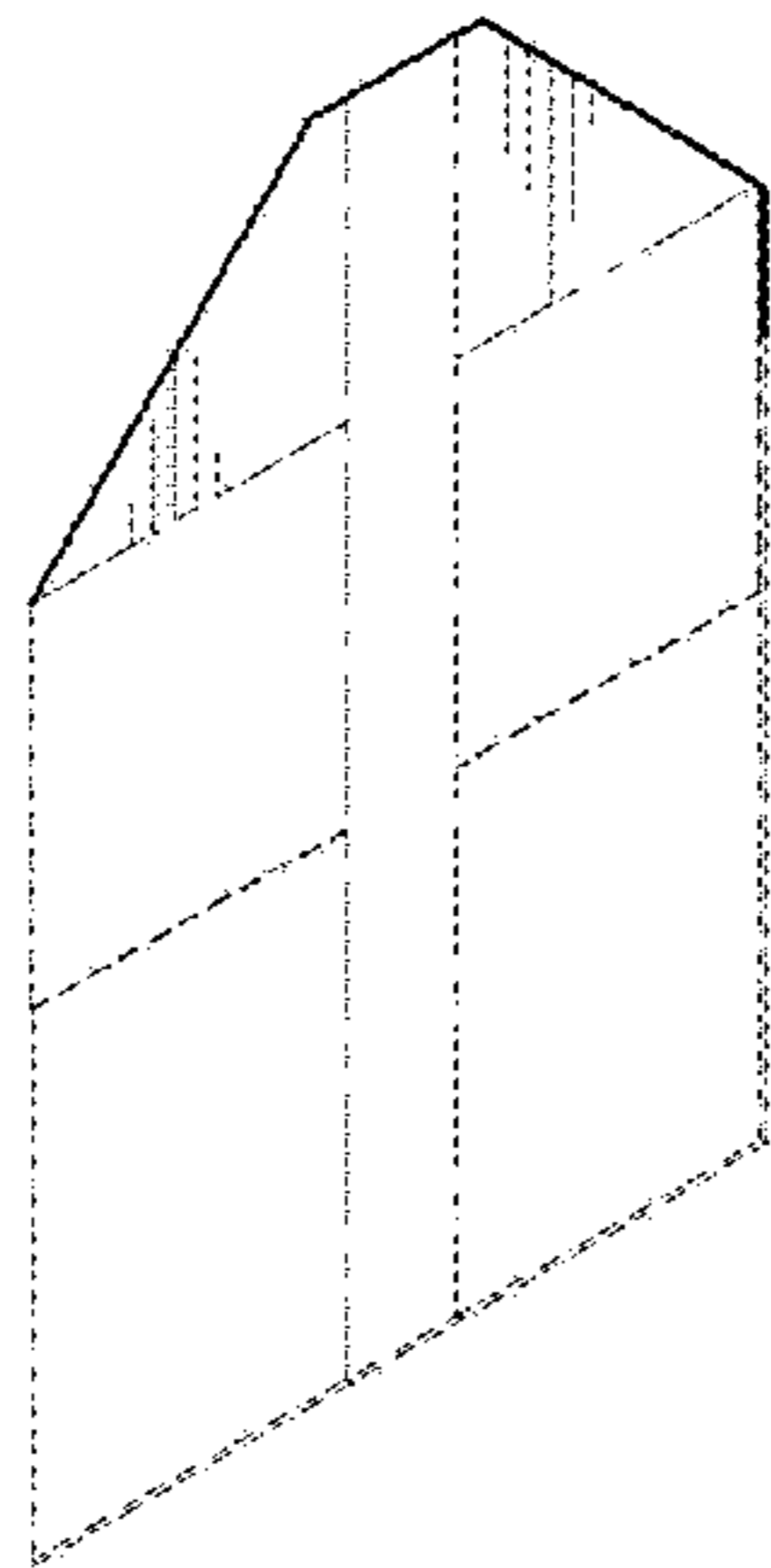

Fig. 28

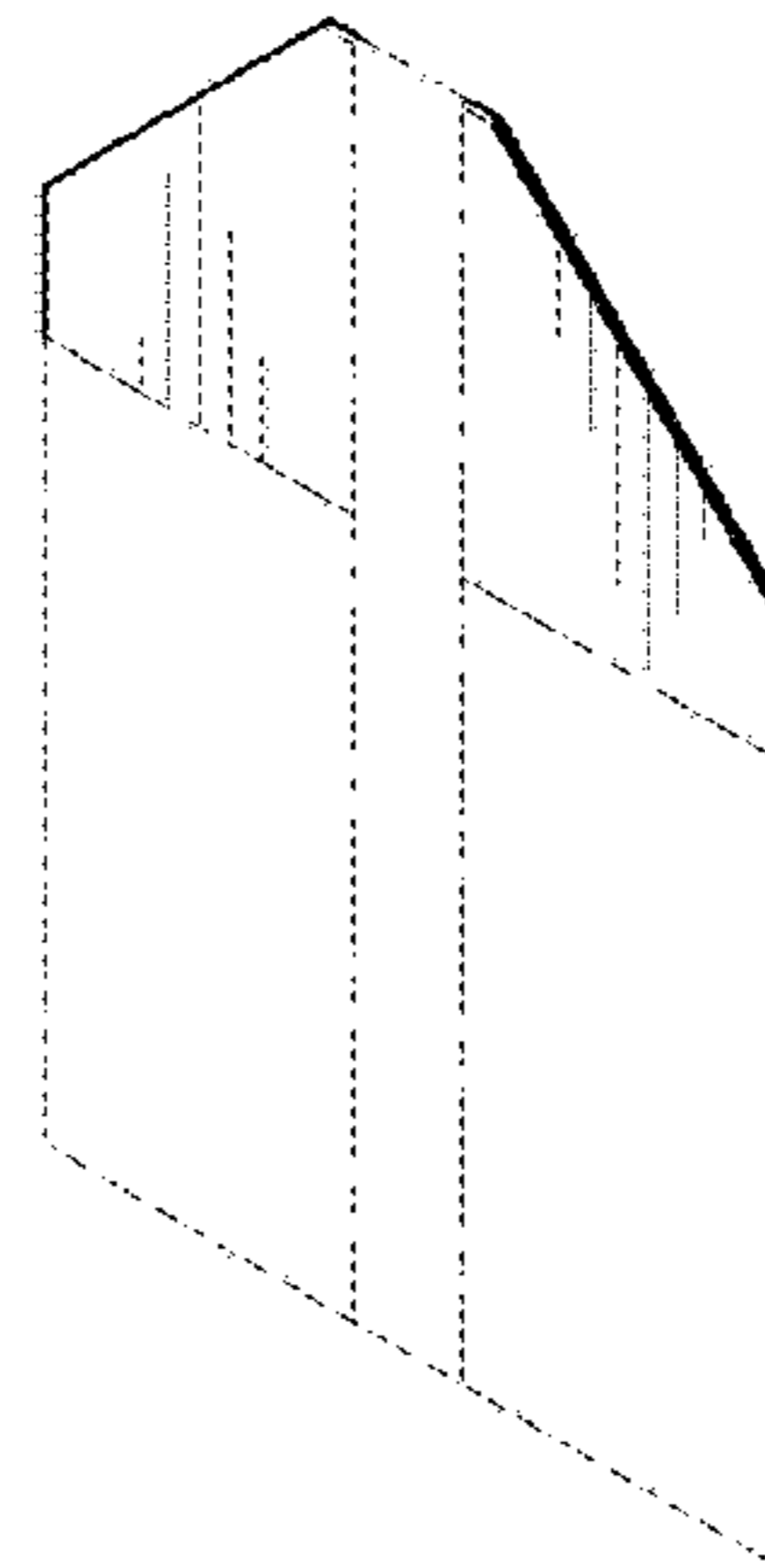

Fig. 29

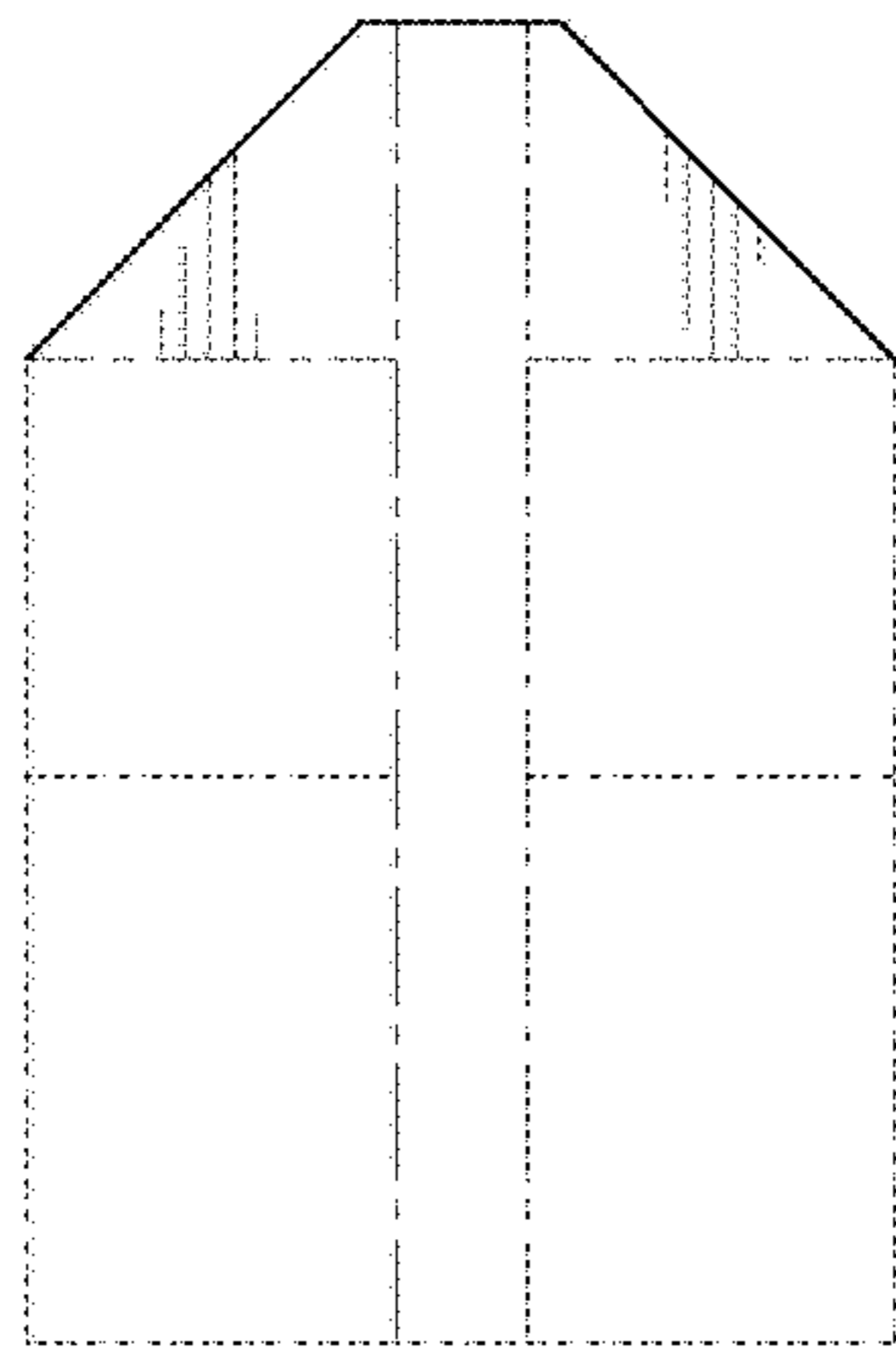

Fig. 30

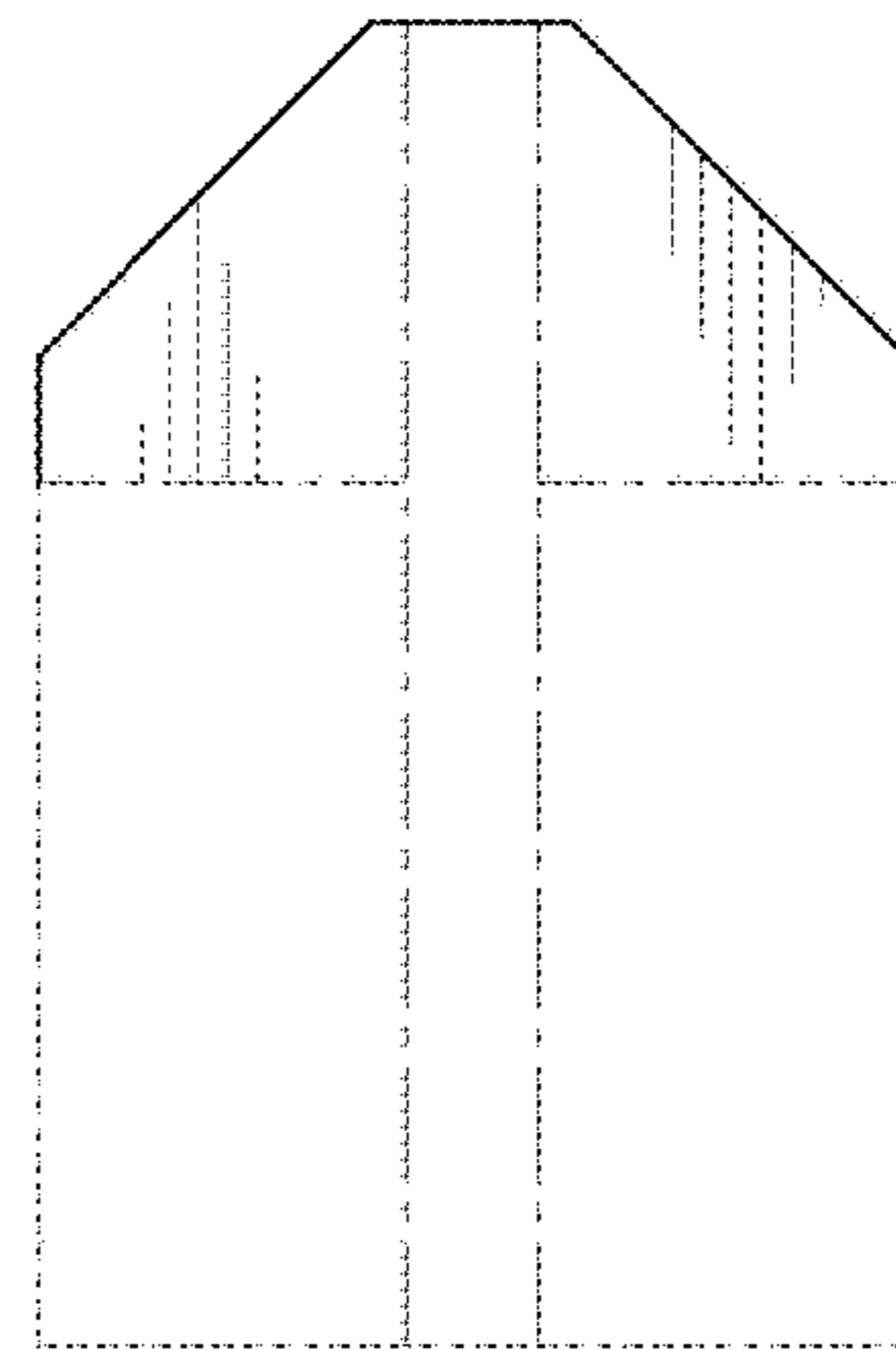

Fig. 31