



US00D836686S

(12) **United States Design Patent** (10) **Patent No.:** **US D836,686 S**
McCloskey et al. (45) **Date of Patent:** **** Dec. 25, 2018**

(54) **BRICK MAKER**

(71) Applicant: **Relevant Play, LLC**, Denver, CO (US)

(72) Inventors: **David C. McCloskey**, Erie, CO (US);
John Bernard Eisert, Loveland, CO (US);
Chad Lucero, Englewood, CO (US);
Heidi Lyn Clemmer, Fort Collins, CO (US)

(73) Assignee: **Relevant Play, LLC**, Denver, CO (US)

(**) Term: **15 Years**

(21) Appl. No.: **29/583,045**

(22) Filed: **Nov. 1, 2016**

(51) **LOC (11) Cl.** **15-03**

(52) **U.S. Cl.**
USPC **D15/135**

(58) **Field of Classification Search**
USPC D15/135, 136; D7/672, 677; D25/124,
D25/136, 137; D21/468, 472, 471, 483,
D21/493, 494, 484
CPC E04C 2/38; E04C 2/46; E04C 1/39; E04C
2/02; E04C 2/24; E04C 2/246; E04C
2/296; E04C 1/397; E04C 2/205; E04C
2/288; E04C 1/00; E04C 1/395; E04C
1/40; E04C 2002/008; E04C 2003/0491;
E04C 2/34; E04C 2/386; E04C 2/525;
E04C 3/08

See application file for complete search history.

(56) **References Cited**

U.S. PATENT DOCUMENTS

D285,796 S * 9/1986 Doyel D15/123
D359,368 S * 6/1995 Anderson D25/136
6,631,595 B1 * 10/2003 Minter E06B 1/62
49/504
D537,962 S * 3/2007 Habeck D25/124
D715,375 S * 10/2014 Li D21/468
D716,383 S * 10/2014 Li D21/468

* cited by examiner

Primary Examiner — Ian Simmons

Assistant Examiner — Khawaja Anwar

(74) *Attorney, Agent, or Firm* — Lathrop Gage LLP

(57) **CLAIM**

The ornamental design for a brick maker, as shown and described.

DESCRIPTION

FIG. 1 is a top-front perspective view of a brick maker in an assembled position showing the new design; FIG. 2 is a side elevation view thereof; FIG. 3 is a front elevation view thereof; FIG. 4 is a top plan view thereof; FIG. 5 is a bottom plan view thereof; FIG. 6 is a top-front perspective view of the brick maker, in an exploded view showing the base, the cutter and the plunger; FIG. 7 is a top-front perspective view of the base of the brick maker; FIG. 8 is a side elevation view thereof; FIG. 9 is a front elevation view thereof; FIG. 10 is a top plan view thereof; FIG. 11 is a bottom plan view thereof; FIG. 12 is a top-front perspective view of the cutter of the brick maker; FIG. 13 is a side elevation view thereof; FIG. 14 is a front elevation view thereof; FIG. 15 is a top plan view thereof; FIG. 16 is a bottom plan view thereof; FIG. 17 is a top front perspective view of the plunger of the brick maker; FIG. 18 is a bottom-front perspective view thereof; FIG. 19 is a side elevation view thereof; FIG. 20 is a front elevation view thereof; FIG. 21 is a top plan view thereof; and, FIG. 22 is a bottom plan view thereof. In FIGS. 1-22, broken lines indicate optional features of the brick maker that form no part of the claimed design.

1 Claim, 22 Drawing Sheets

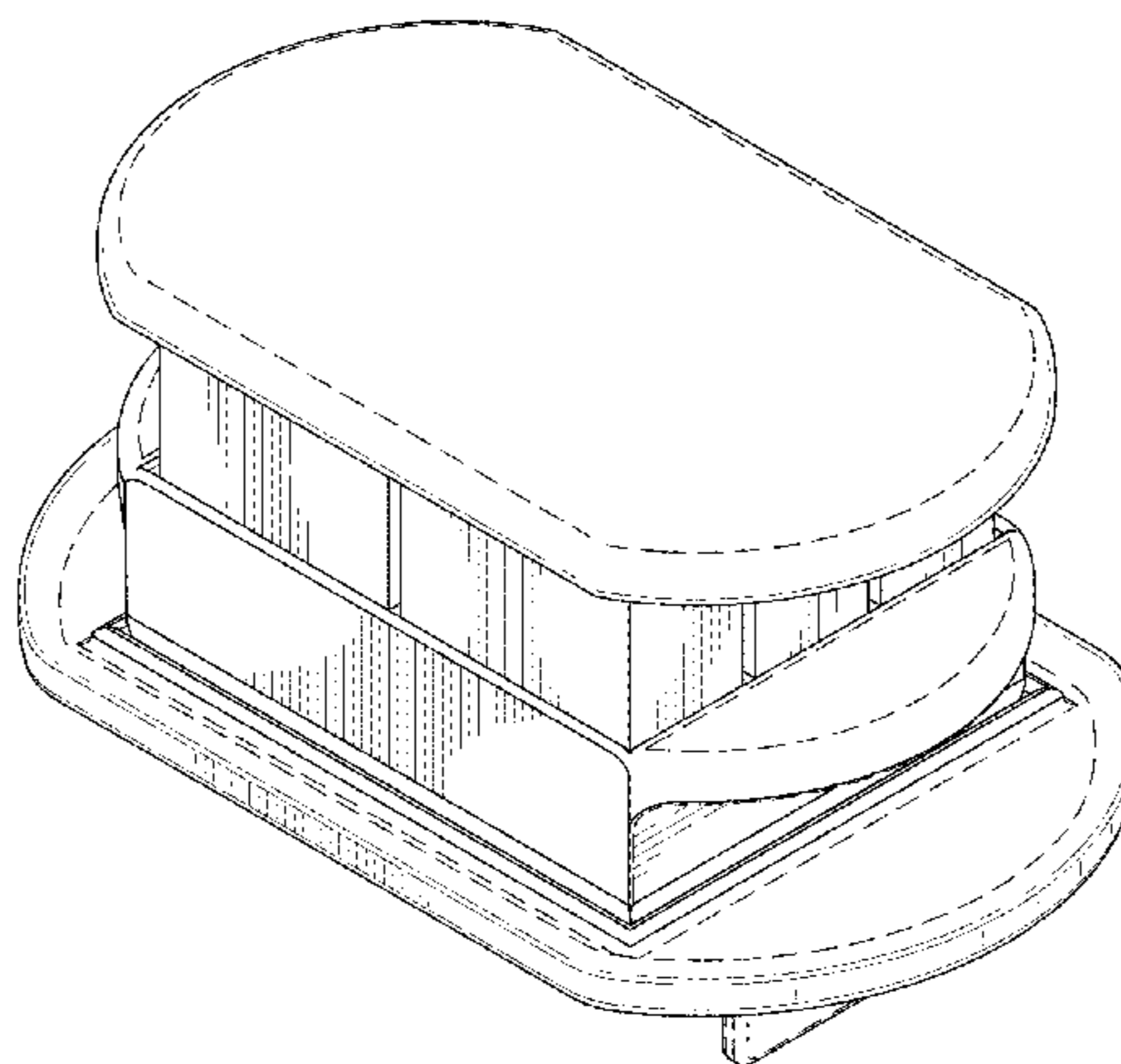

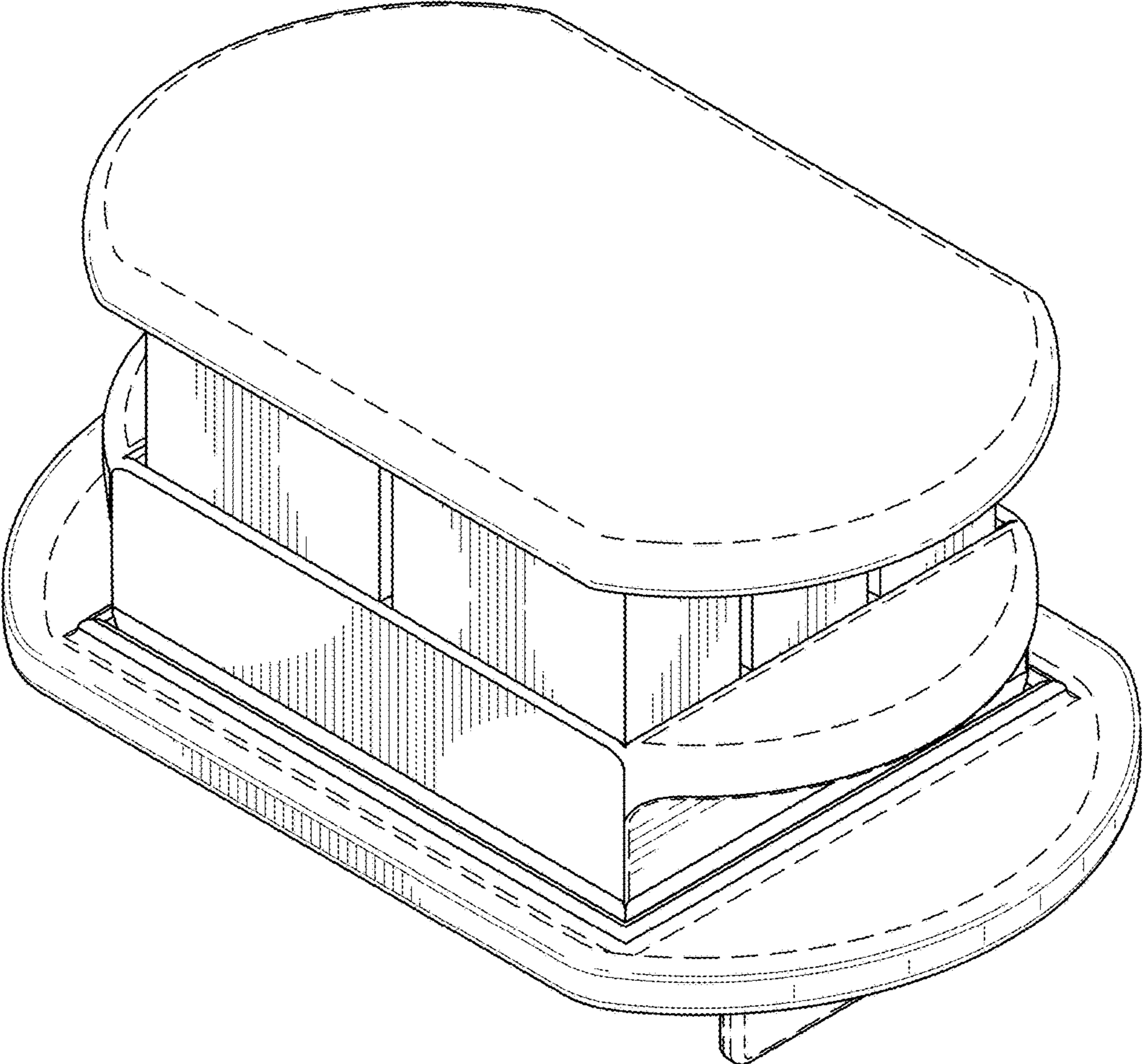

FIG. 1

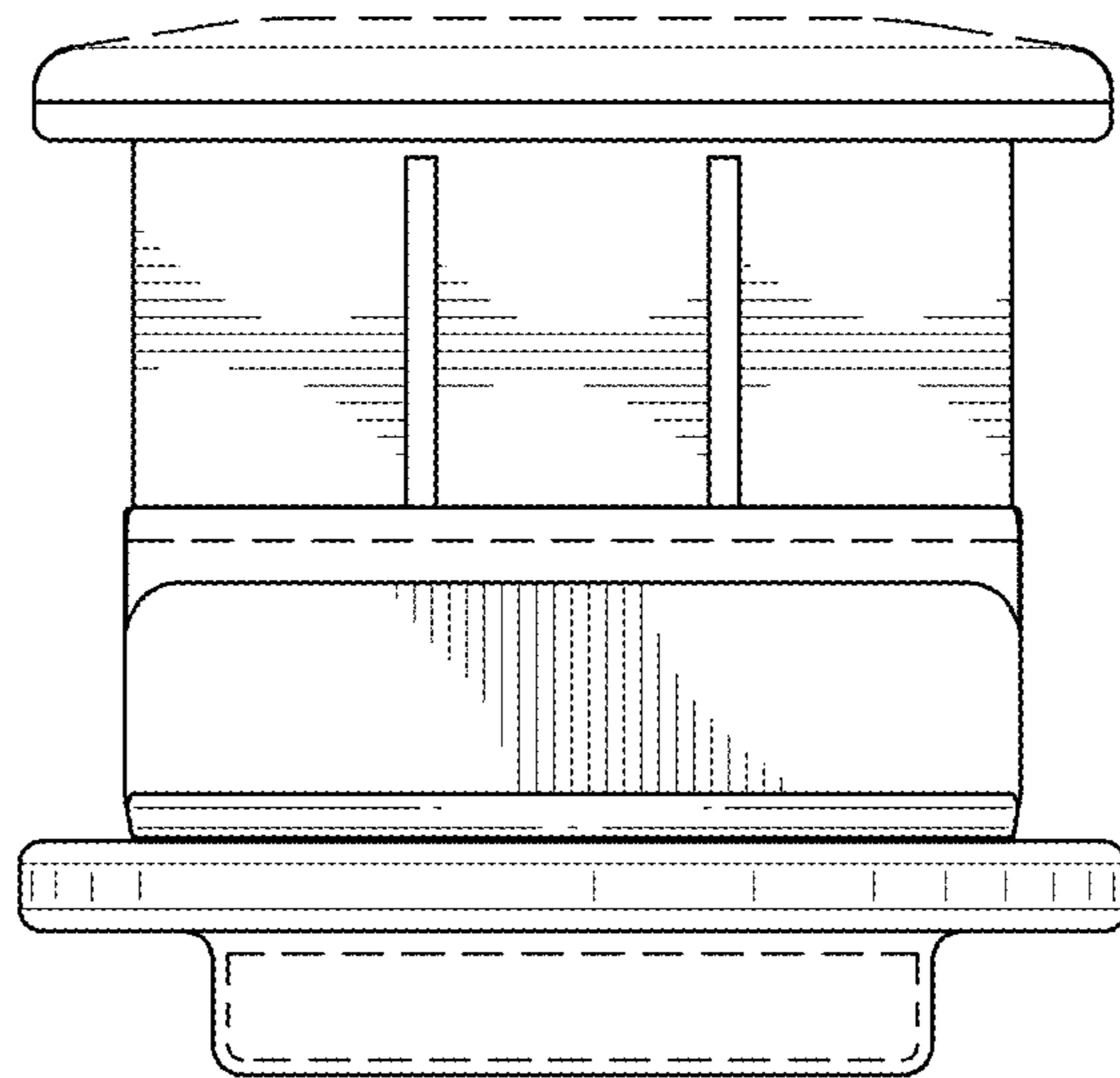

FIG. 2

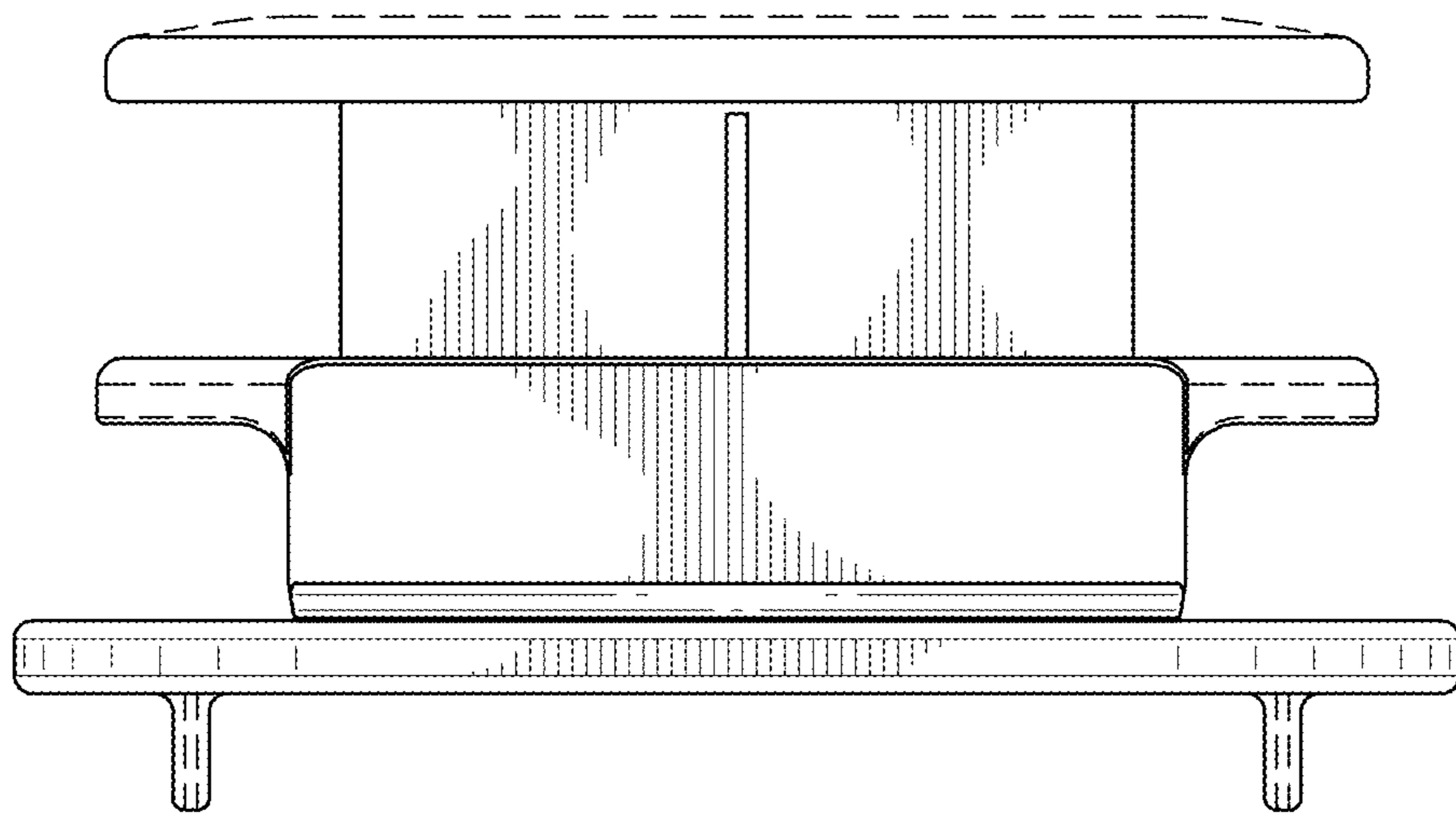

FIG. 3

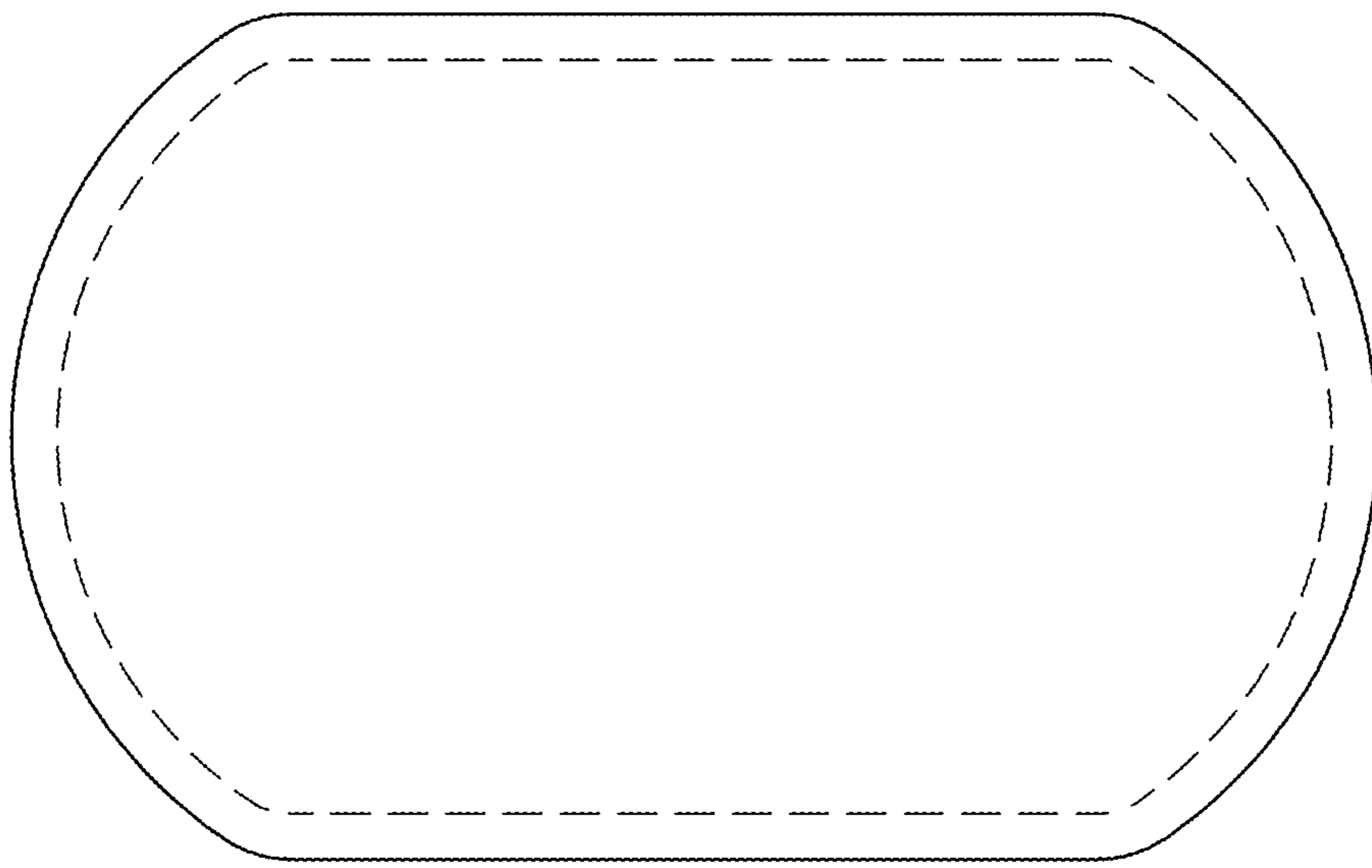

FIG. 4

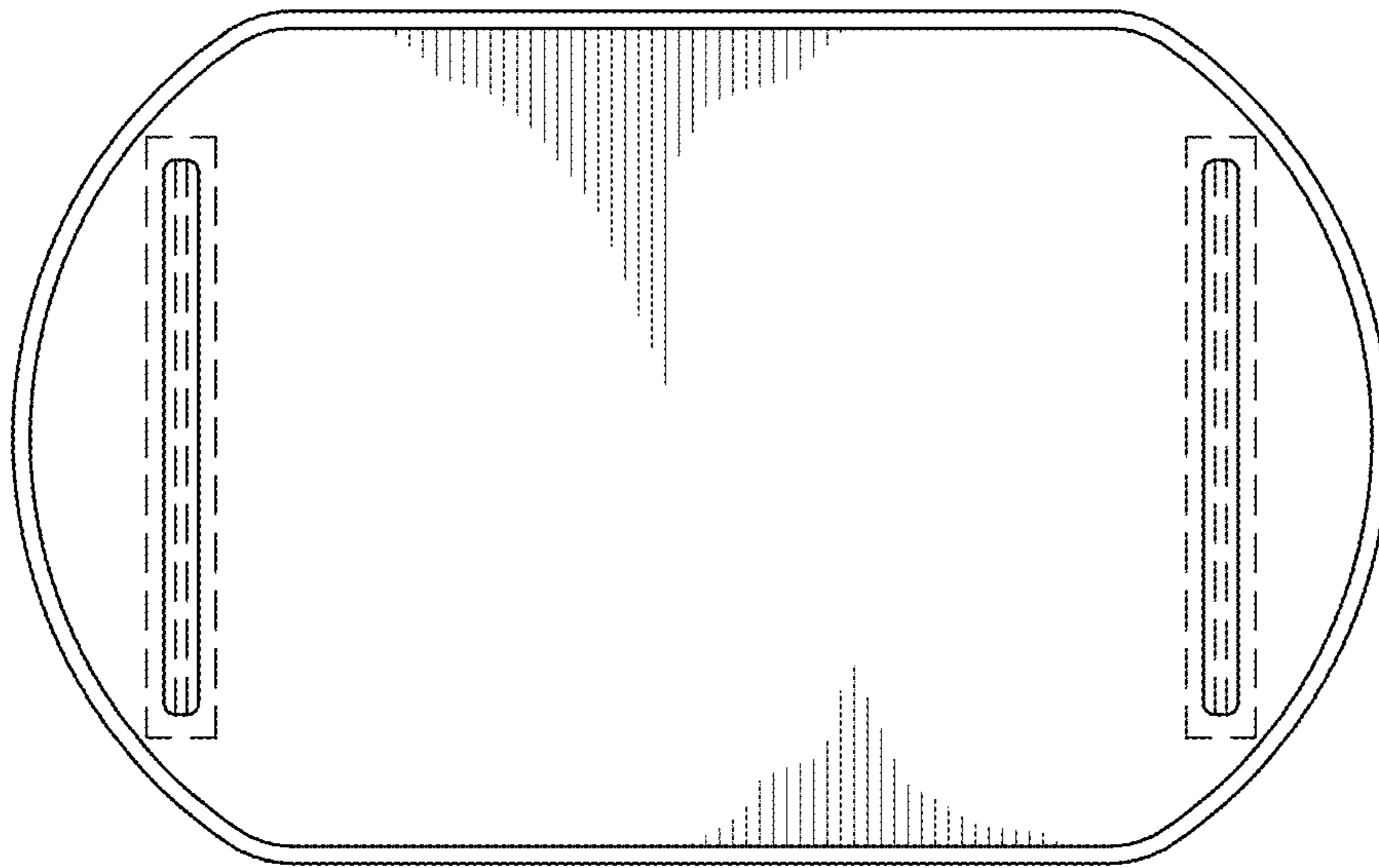

FIG. 5

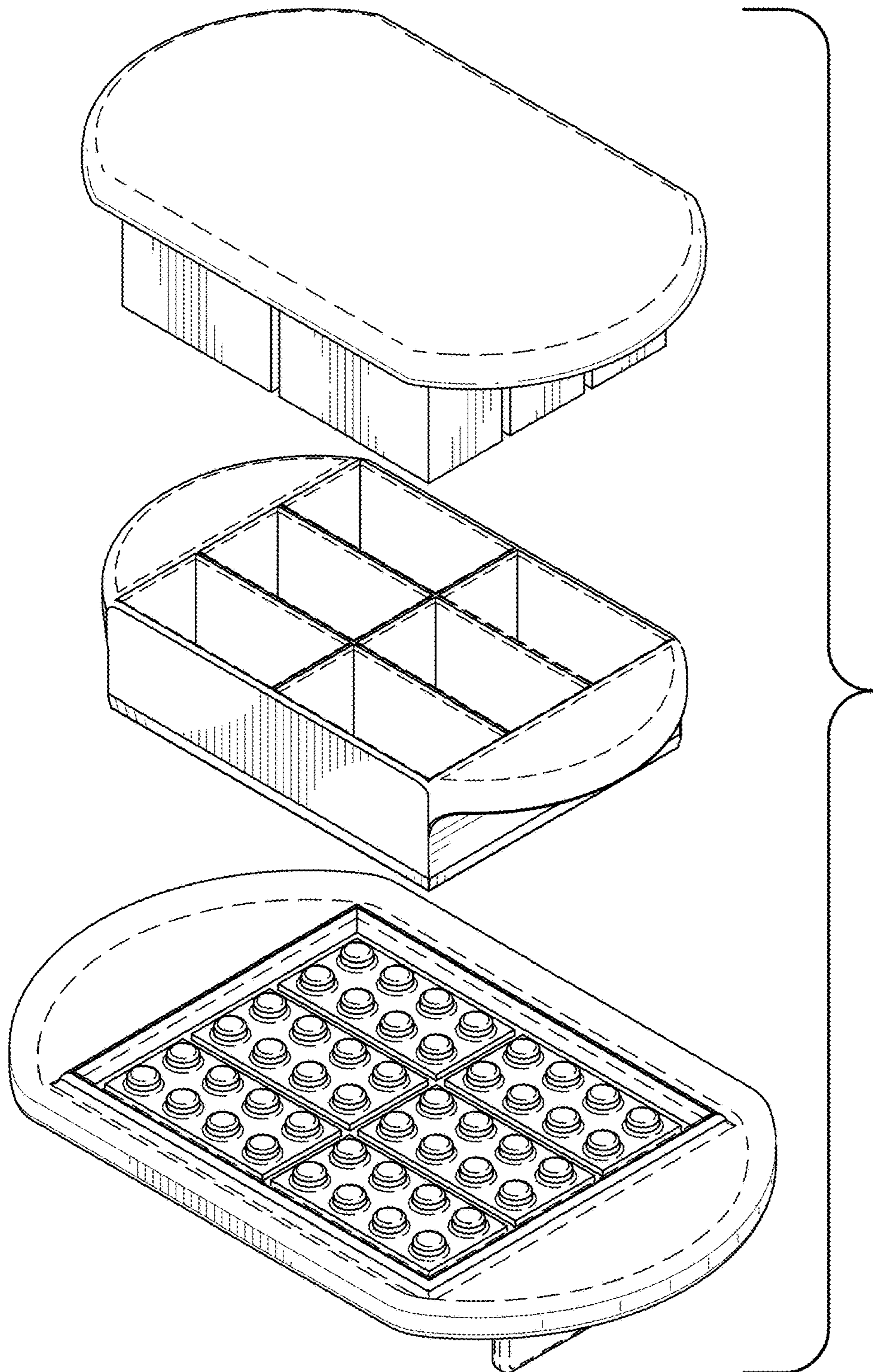

FIG. 6

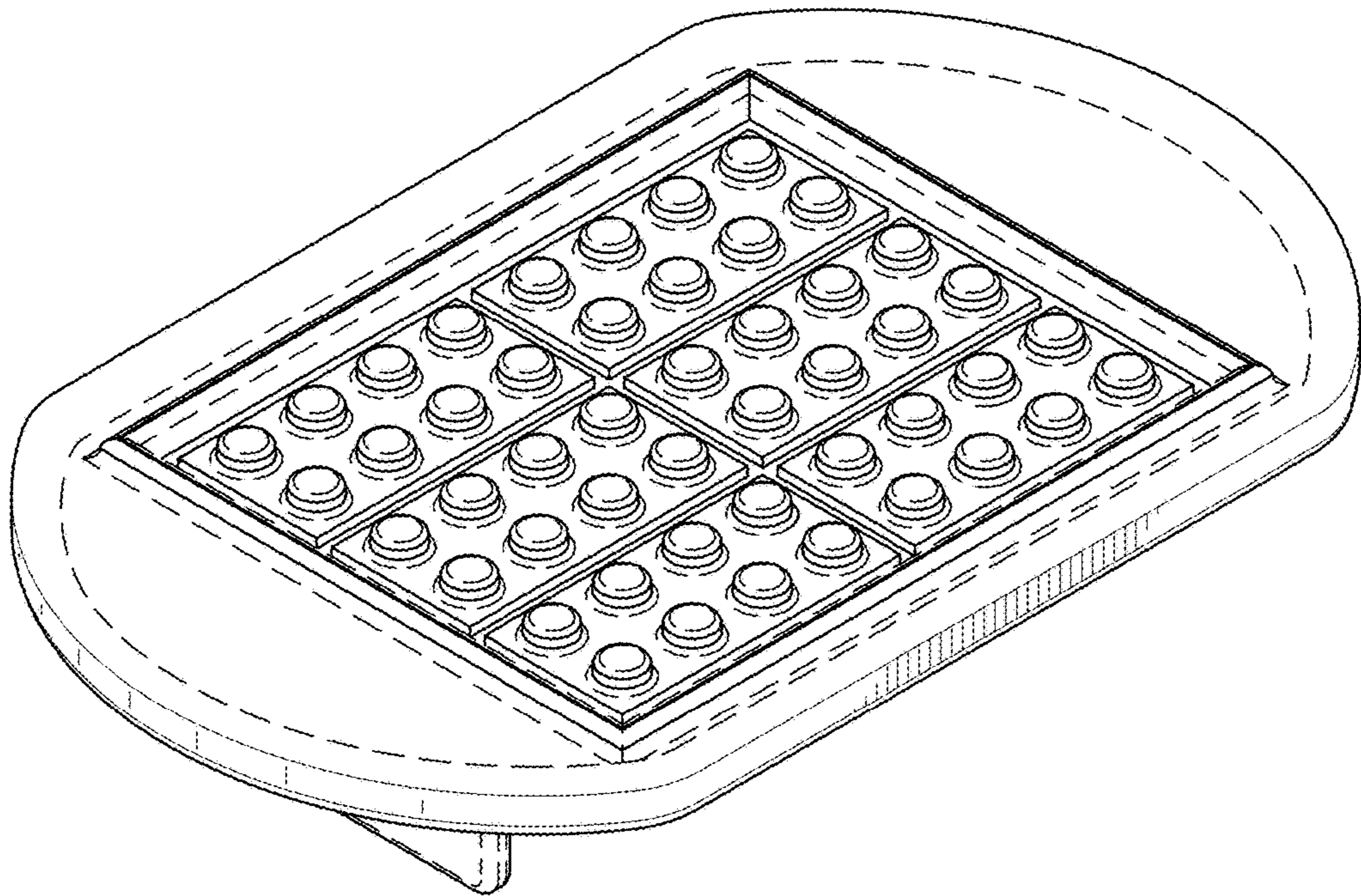

FIG. 7



FIG. 8

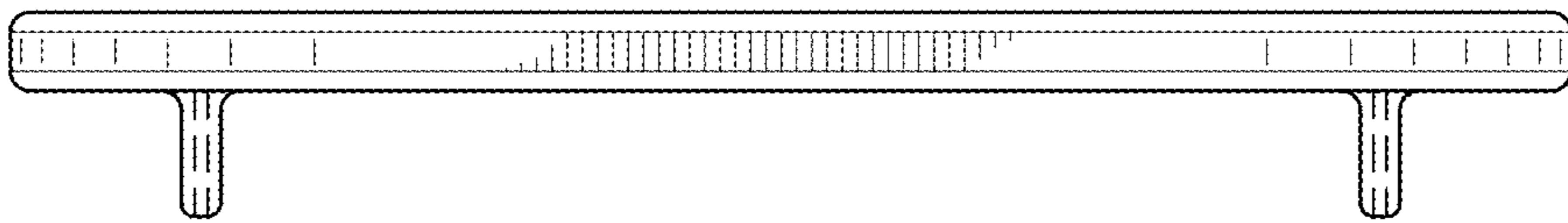

FIG. 9

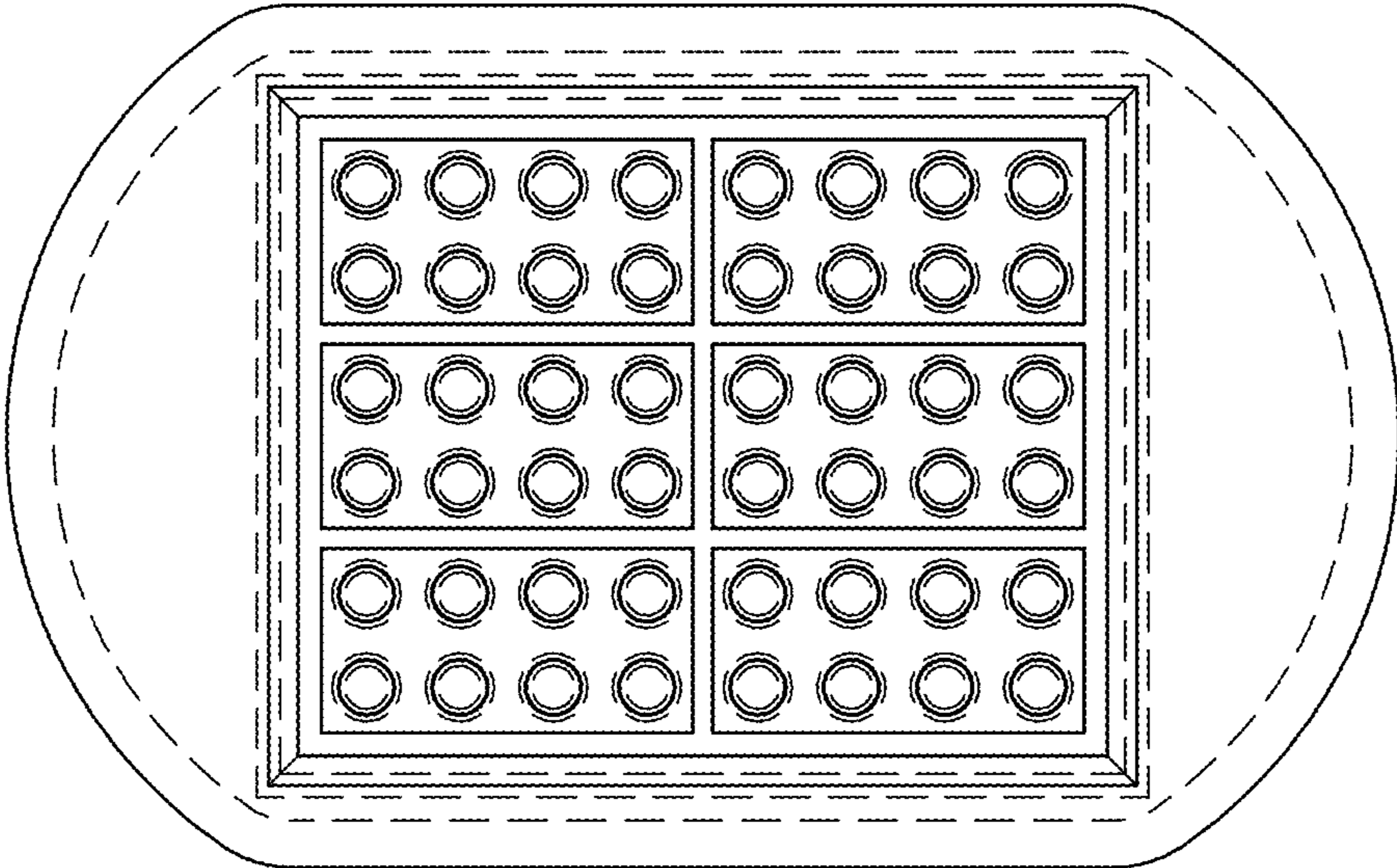

FIG. 10

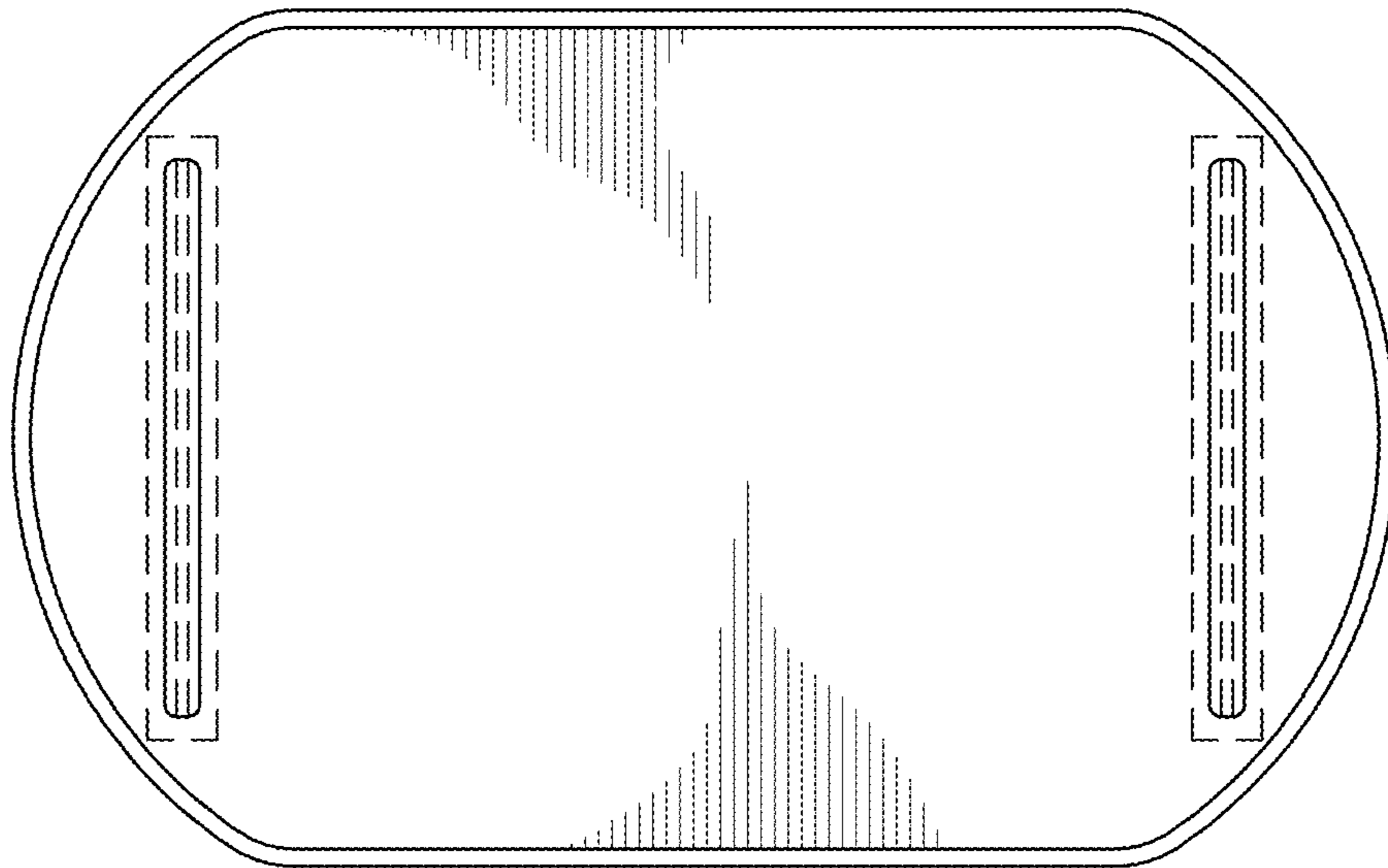

FIG. 11

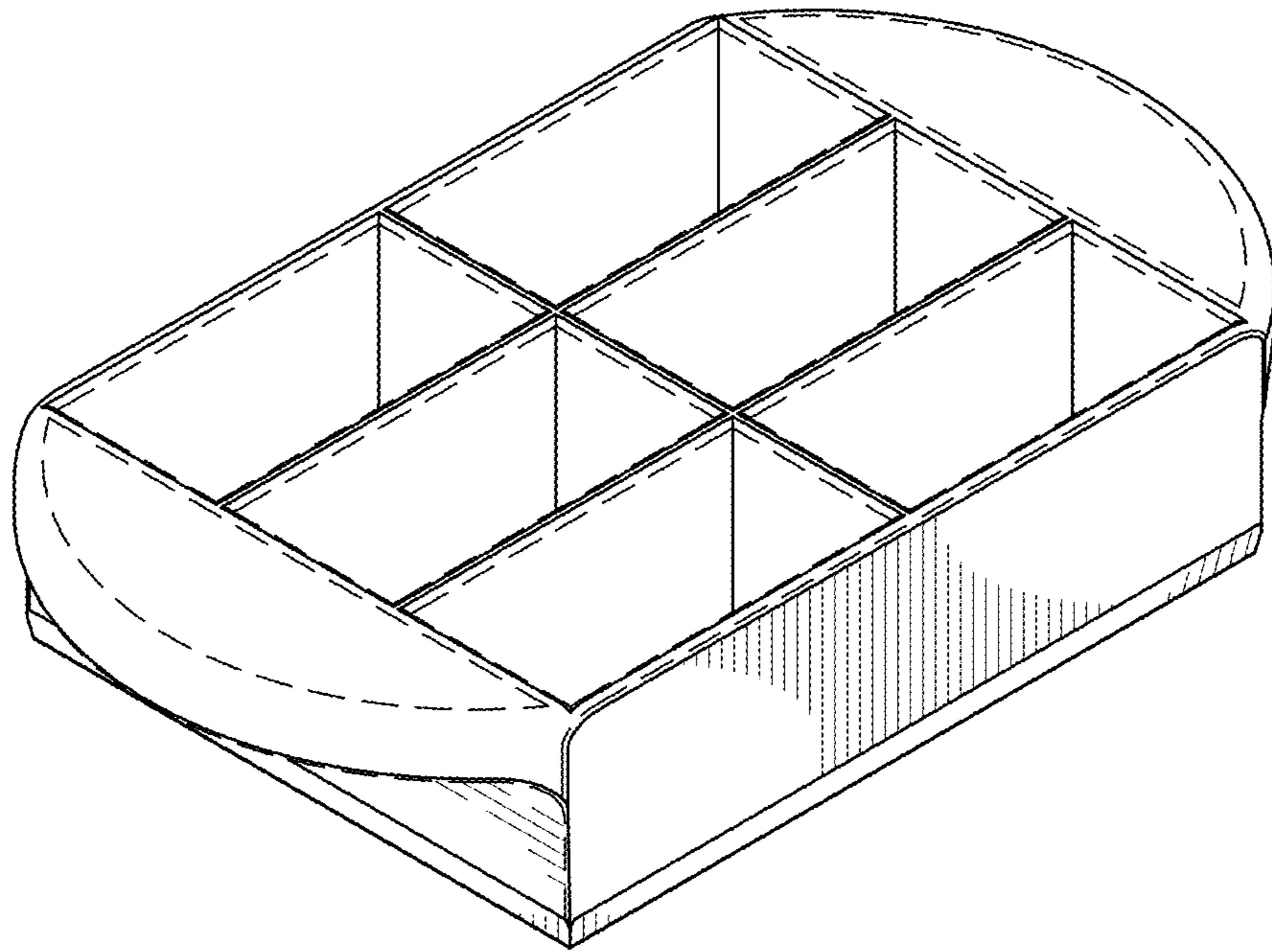

FIG. 12

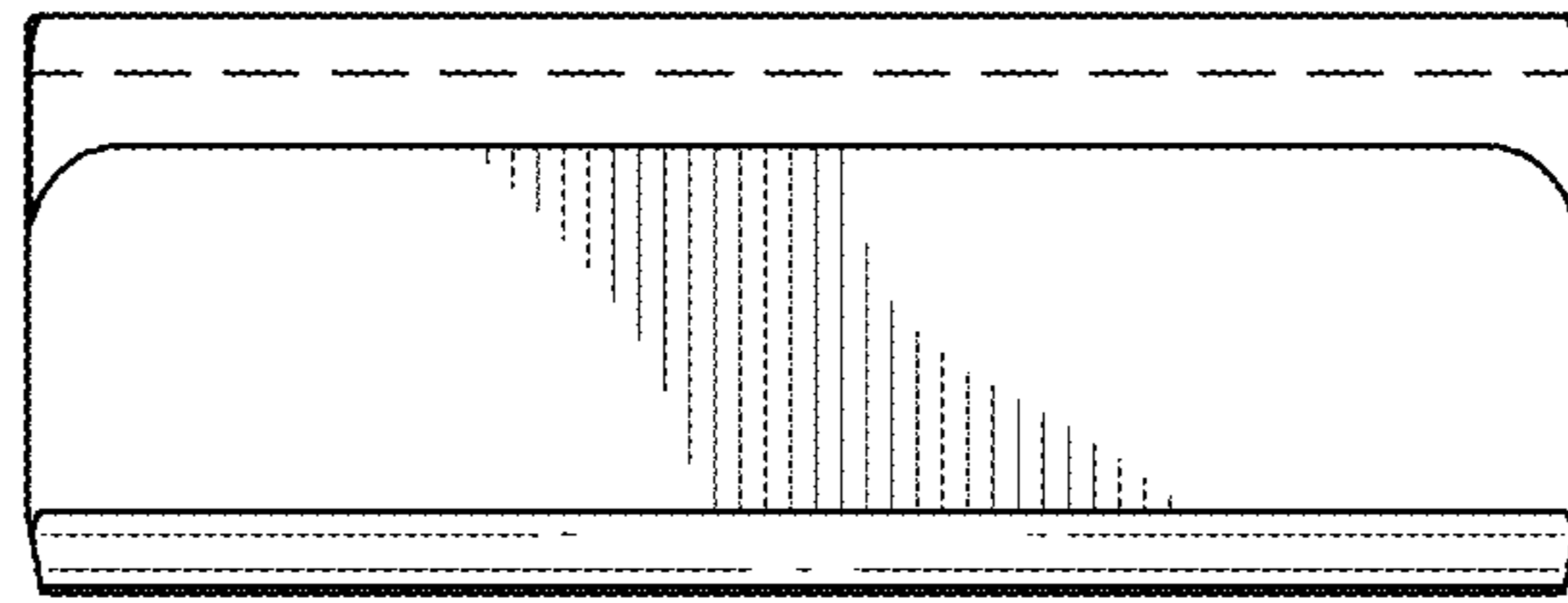

FIG. 13

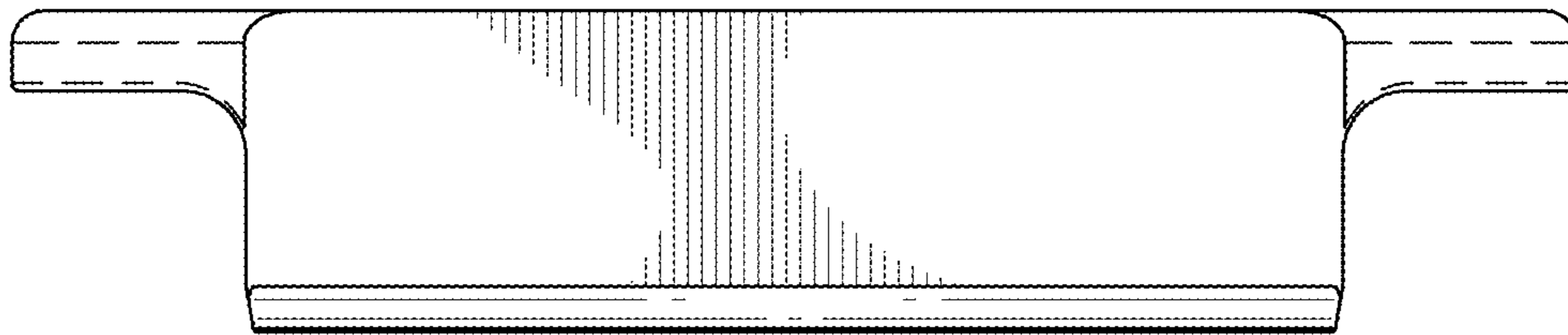

FIG. 14

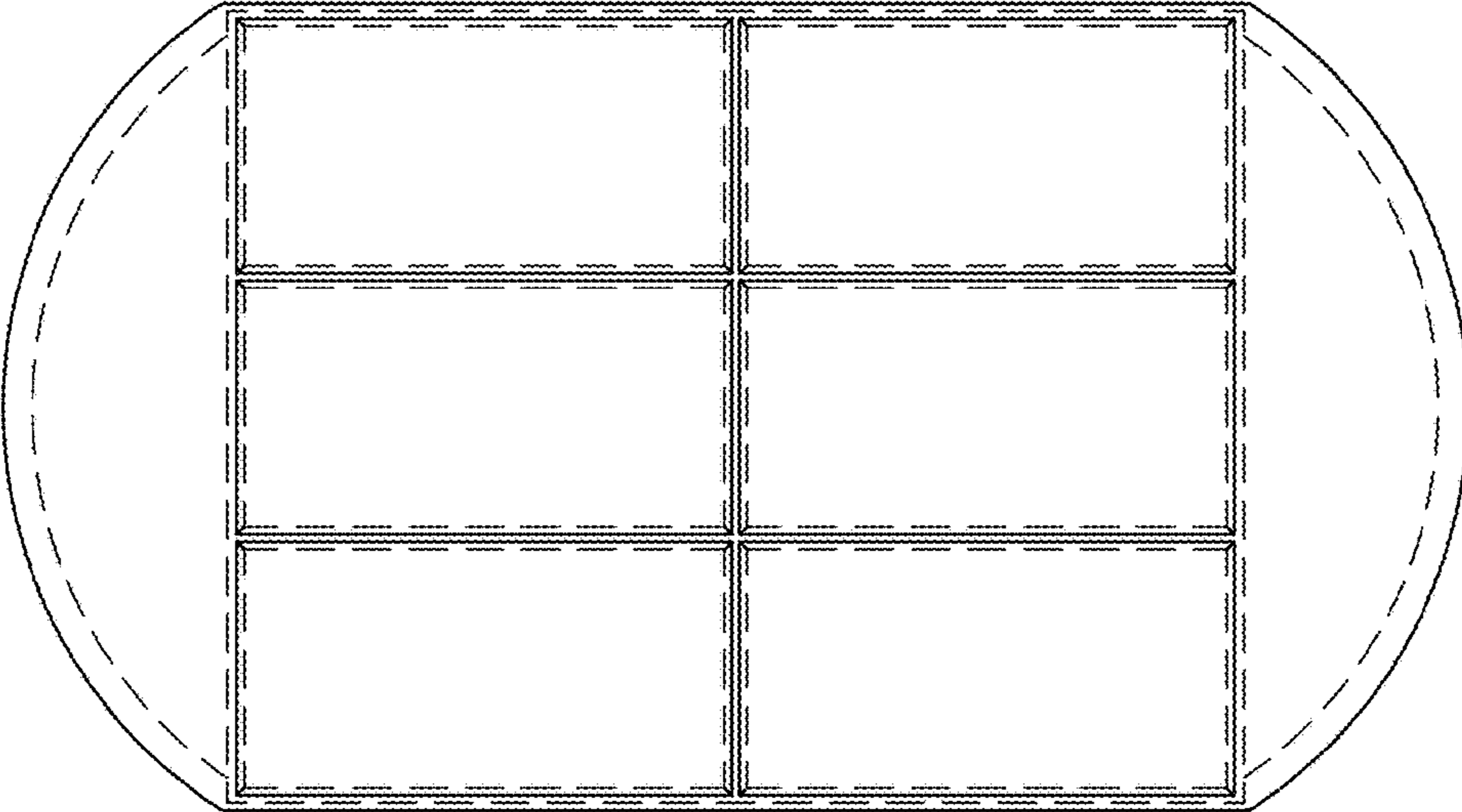

FIG. 15

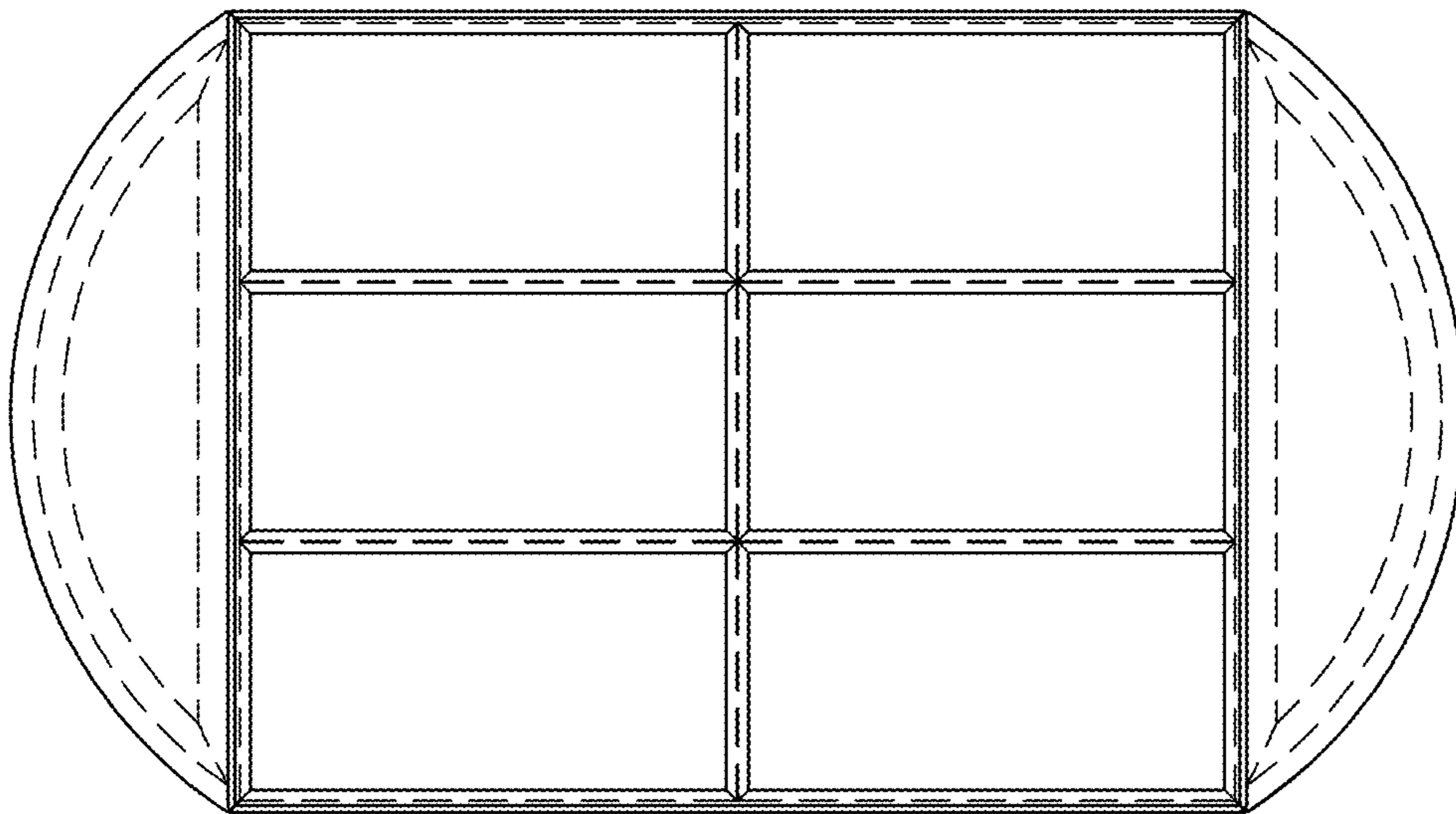

FIG. 16

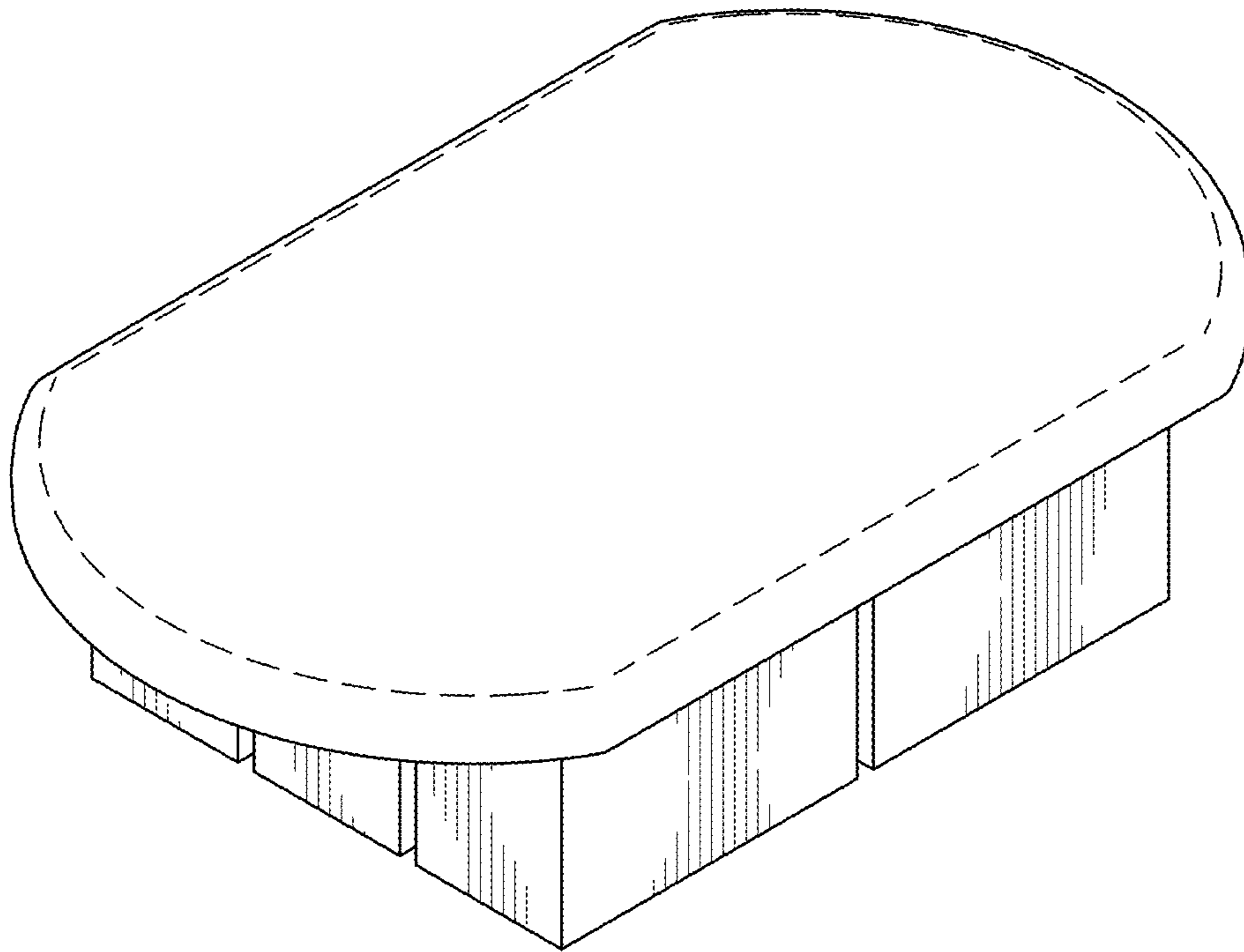

FIG. 17

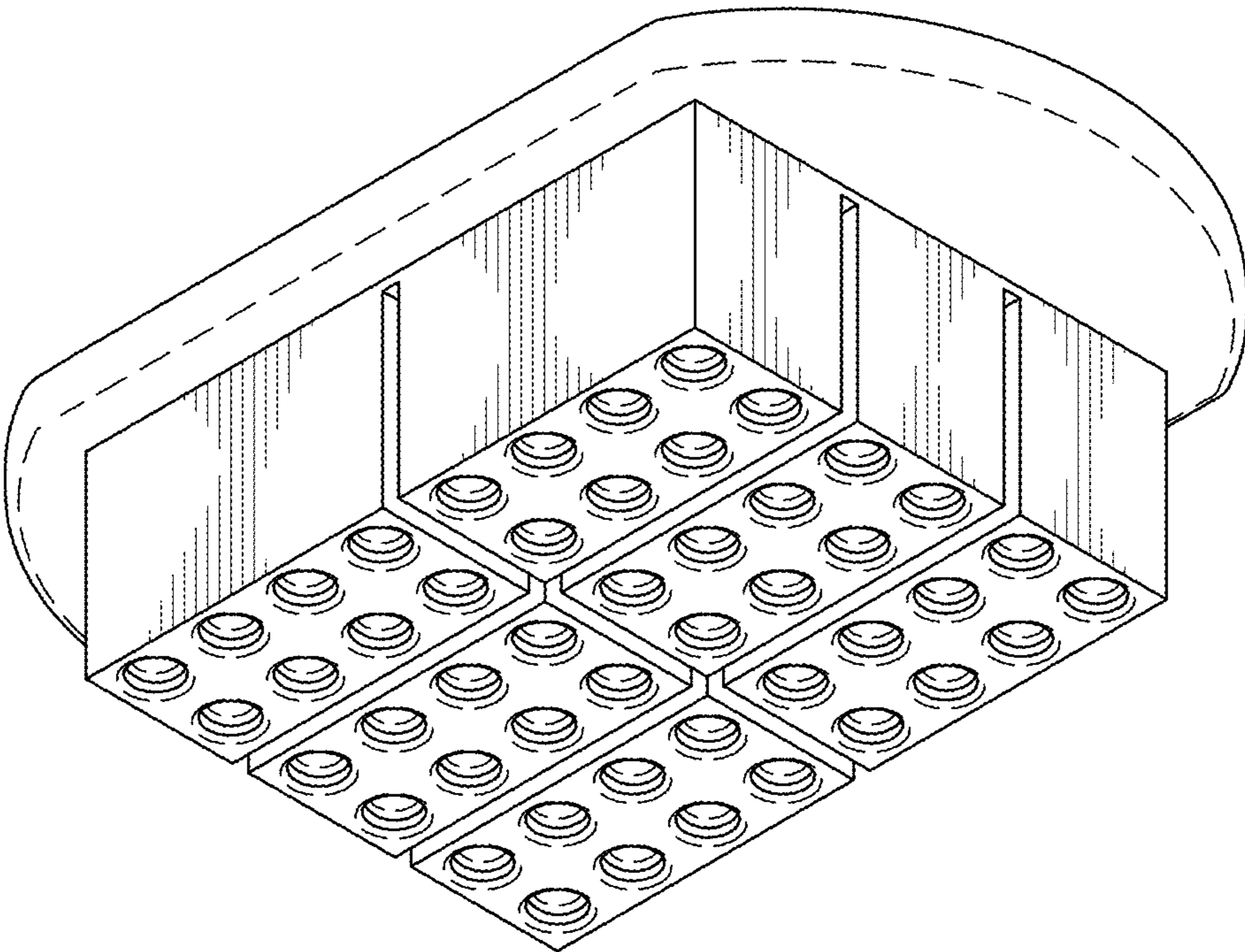

FIG. 18

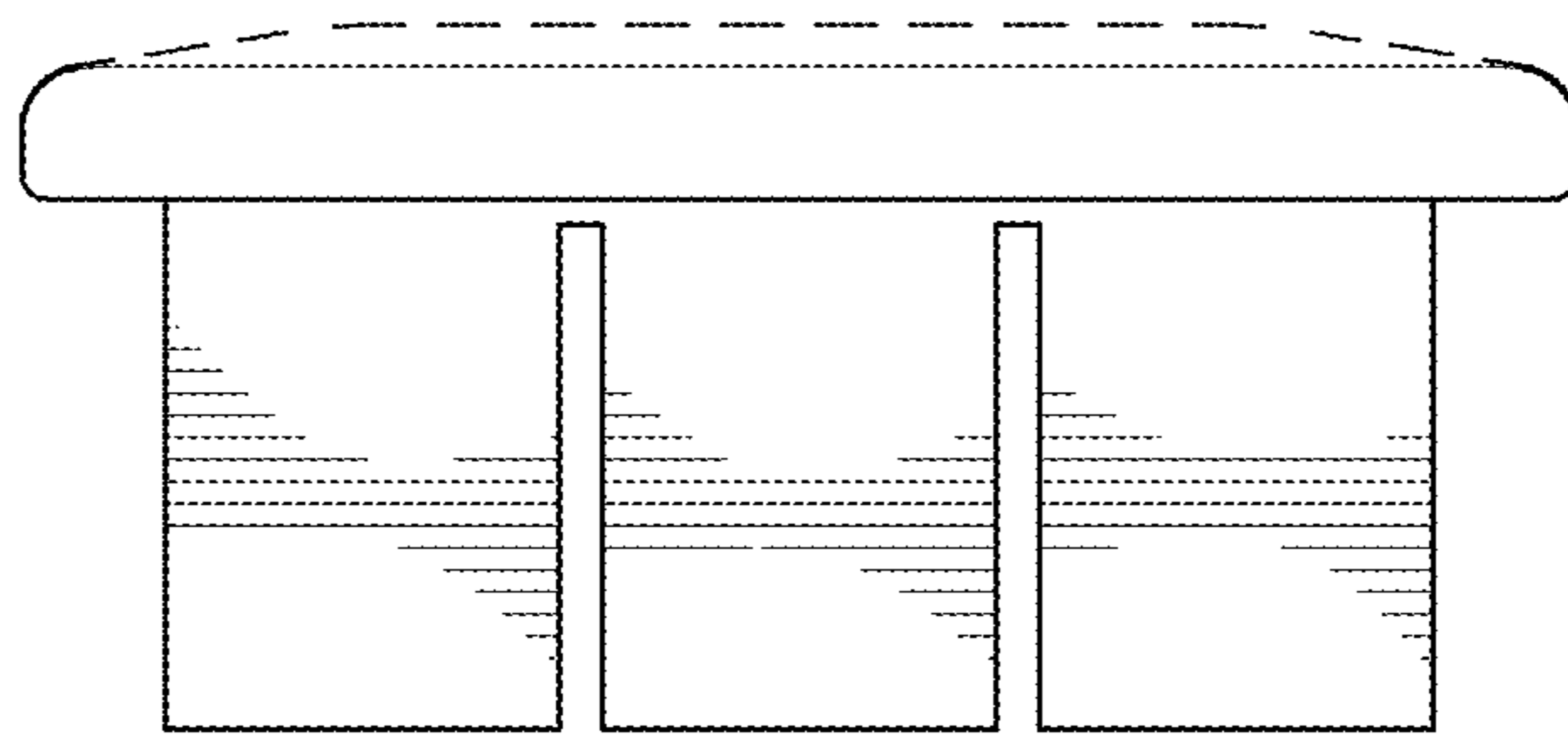

FIG. 19

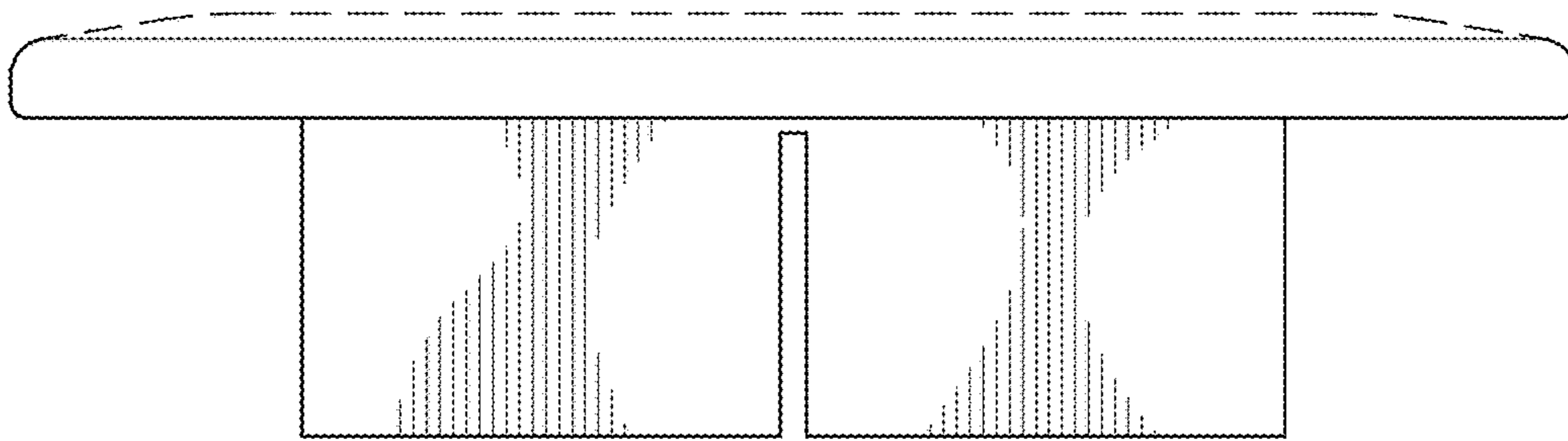

FIG. 20



FIG. 21

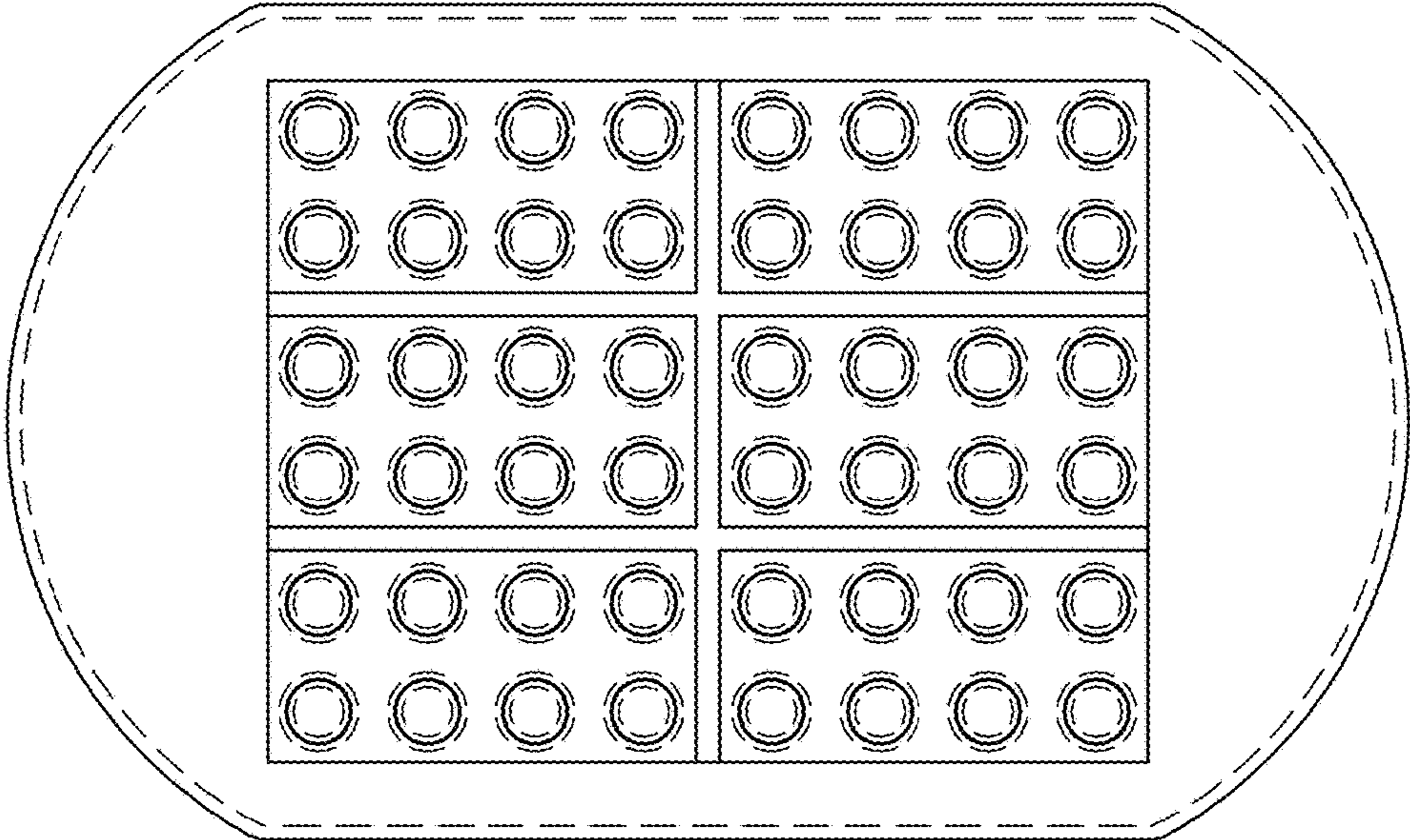

FIG. 22