



US00D836640S

(12) **United States Design Patent** (10) **Patent No.:** **US D836,640 S**  
**Hou** (45) **Date of Patent:** **\*\* Dec. 25, 2018**

(54) **PORT REPLICATOR**

(71) Applicant: **NO NDA INC.**, Mountain View, CA (US)

(72) Inventor: **Peikai Hou**, Fremont, CA (US)

(\*\*) Term: **15 Years**

(21) Appl. No.: **29/580,240**

(22) Filed: **Oct. 6, 2016**

**Related U.S. Application Data**

(62) Division of application No. 29/529,680, filed on Jun. 9, 2015, now Pat. No. Des. 776,659.

(51) **LOC (11) Cl.** ..... **14-02**

(52) **U.S. Cl.**  
USPC ..... **D14/433**

(58) **Field of Classification Search**  
USPC ..... D14/240, 242, 356, 358, 363, 365, 367, D14/370, 432-437, 439, 498, 125, 366, D14/168, 496; D13/147, 164, 123, 133, D13/146, 110, 199, 103, 162, 159, 160, D13/184; 361/683, 684, 686, 724, 735, 361/737, 752; D18/40

CPC .... H01R 25/006; H01R 27/02; H01R 31/005; G06F 13/4022; G06F 13/382; G06F 1/1632; G06F 1/1684; G06F 1/20; G06F 1/1607

See application file for complete search history.

(56) **References Cited**

**U.S. PATENT DOCUMENTS**

D379,627 S \* 6/1997 Takahashi ..... D14/171  
D591,270 S \* 4/2009 Jakobson ..... D14/217  
D664,146 S \* 7/2012 Hoehn ..... D14/433  
D751,527 S \* 3/2016 Hinokio ..... D14/204  
D776,659 S \* 1/2017 Hou ..... D14/433  
D788,112 S \* 5/2017 Liao ..... D14/433  
D803,833 S \* 11/2017 He ..... D14/385

D808,392 S \* 1/2018 Bo ..... D14/433  
D815,091 S \* 4/2018 Nguyen ..... D14/356  
D815,639 S \* 4/2018 Lau ..... D14/433  
D819,619 S \* 6/2018 Li ..... D14/240

(Continued)

*Primary Examiner* — Austin Murphy

(74) *Attorney, Agent, or Firm* — Michael J. Sullivan

(57) **CLAIM**

The ornamental design for a port replicator, as shown and described.

**DESCRIPTION**

FIG. 1 is a front, top, and right side perspective view of a port replicator showing our new design according to a first embodiment;

FIG. 2 is a front, bottom, and right side perspective view thereof;

FIG. 3 is a right side elevational view thereof;

FIG. 4 is a left side elevational view thereof;

FIG. 5 is a front side elevational view thereof;

FIG. 6 is rear side elevational view thereof;

FIG. 7 is a top plan view thereof;

FIG. 8 is a bottom plan view thereof;

FIG. 9 is a front, top, and right side perspective view of a port replicator showing our new design according to a second embodiment;

FIG. 10 is a front, bottom, and right side perspective view thereof;

FIG. 11 is a right side elevational view thereof;

FIG. 12 is a left side elevational view thereof;

FIG. 13 is a front side elevational view thereof;

FIG. 14 is rear side elevational view thereof;

FIG. 15 is a top plan view thereof; and,

FIG. 16 is a bottom plan view thereof.

The broken lines in the drawings showing portions of the port replicator are included for the purpose of illustrating environmental structure and form no part of the claimed design.

**1 Claim, 16 Drawing Sheets**

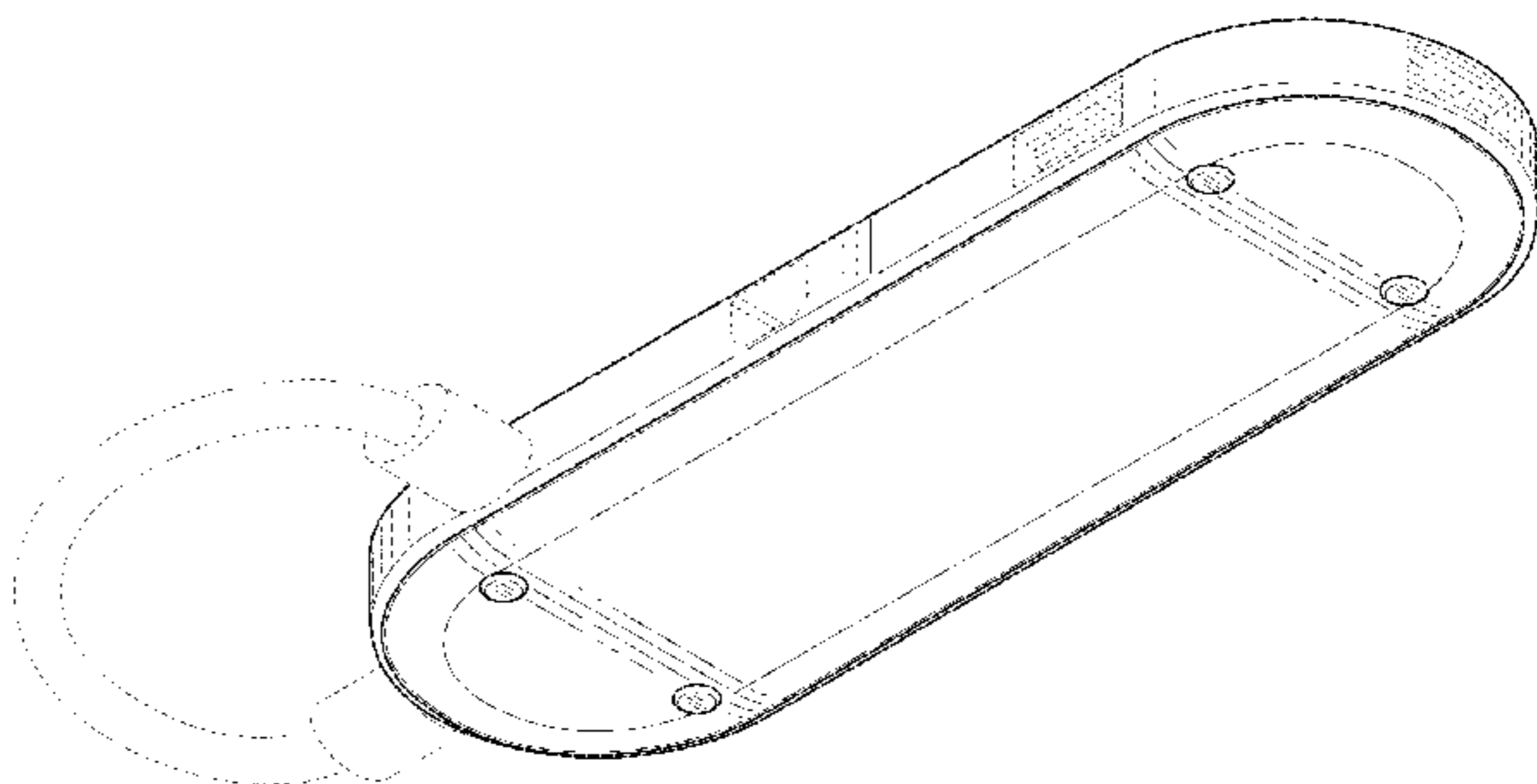
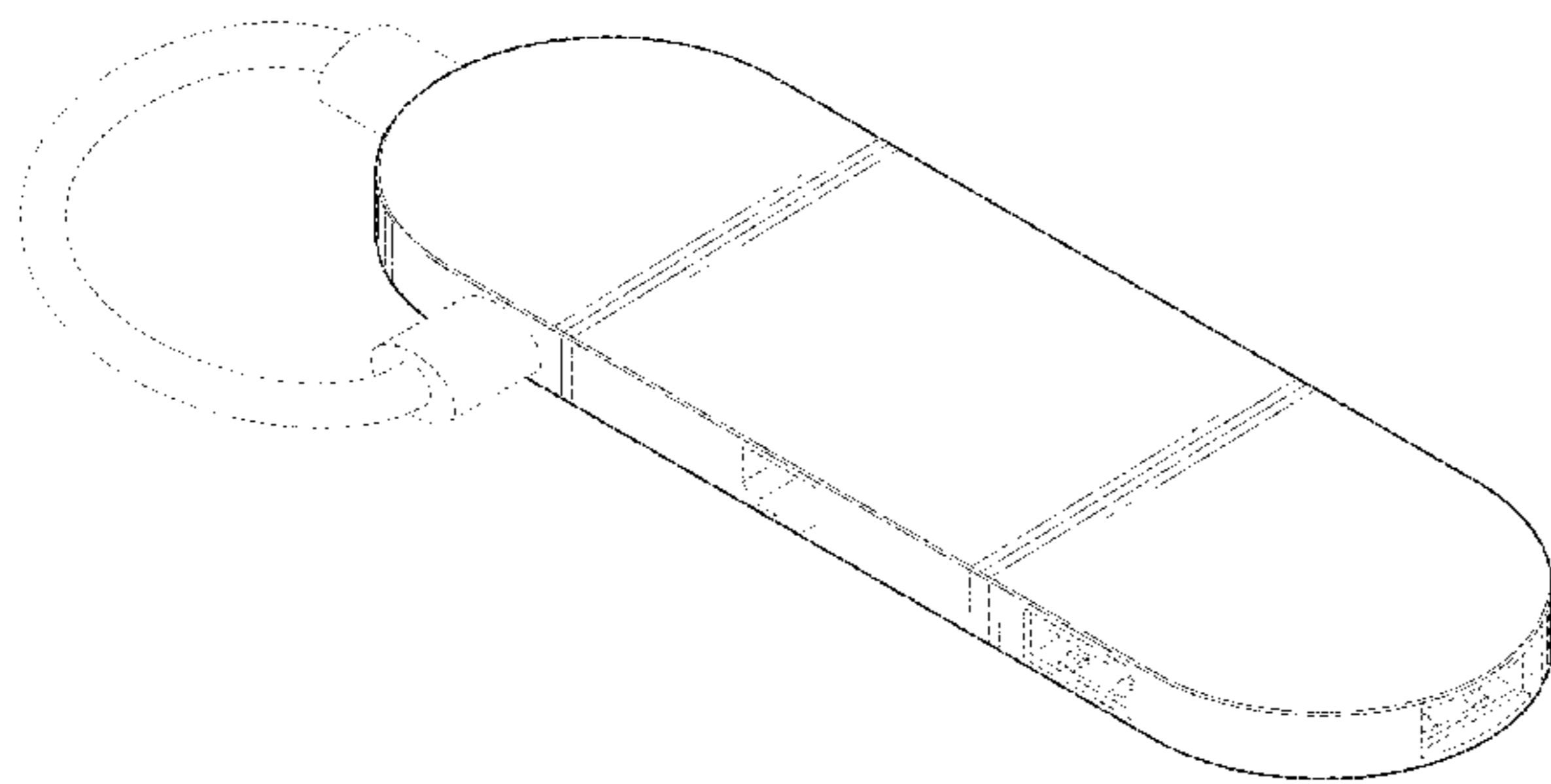

(56)

**References Cited**

U.S. PATENT DOCUMENTS

D828,840 S \* 9/2018 Zhang ..... D14/433  
D828,841 S \* 9/2018 Zhang ..... D14/433

\* cited by examiner

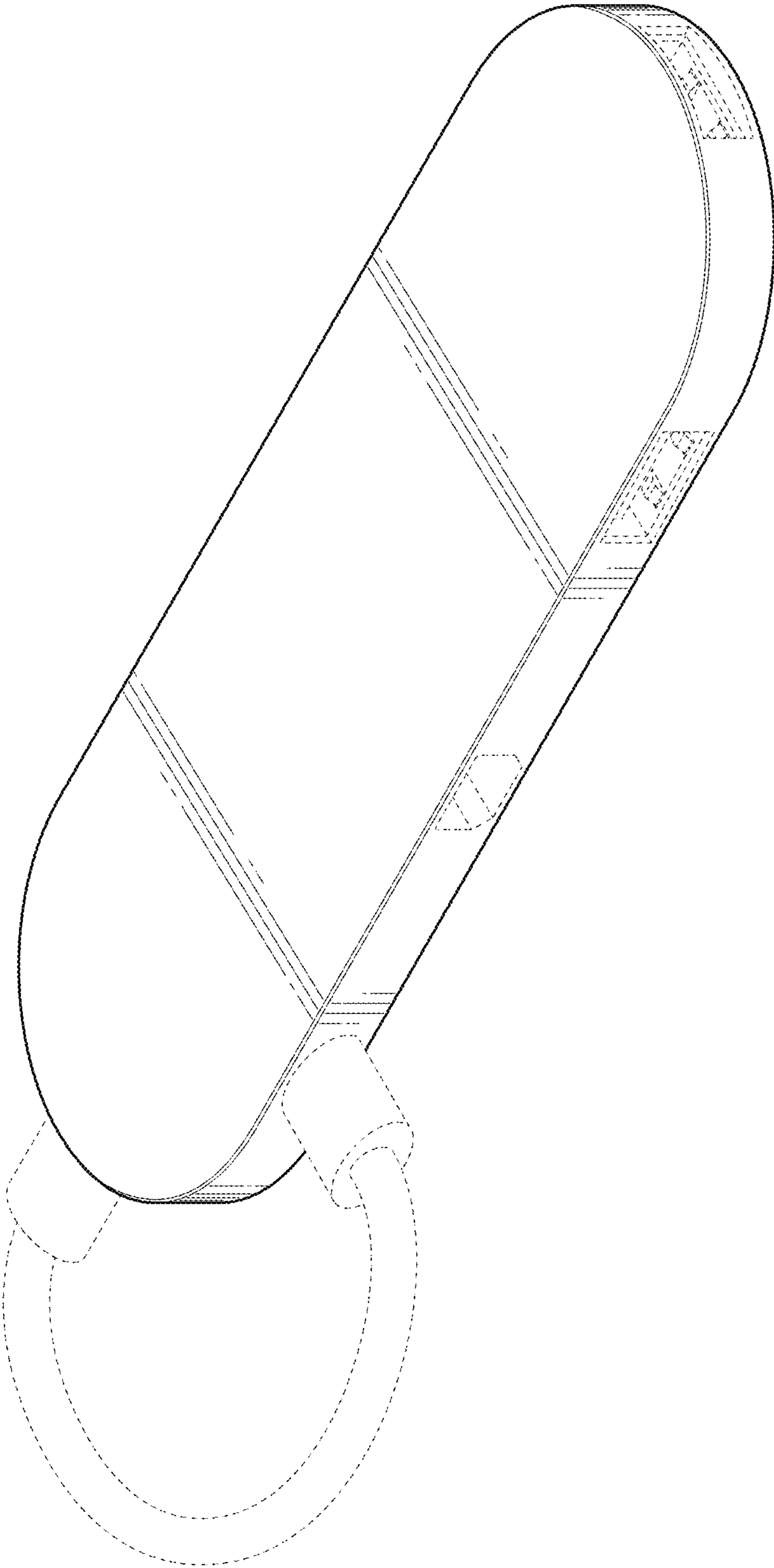

FIG. 1

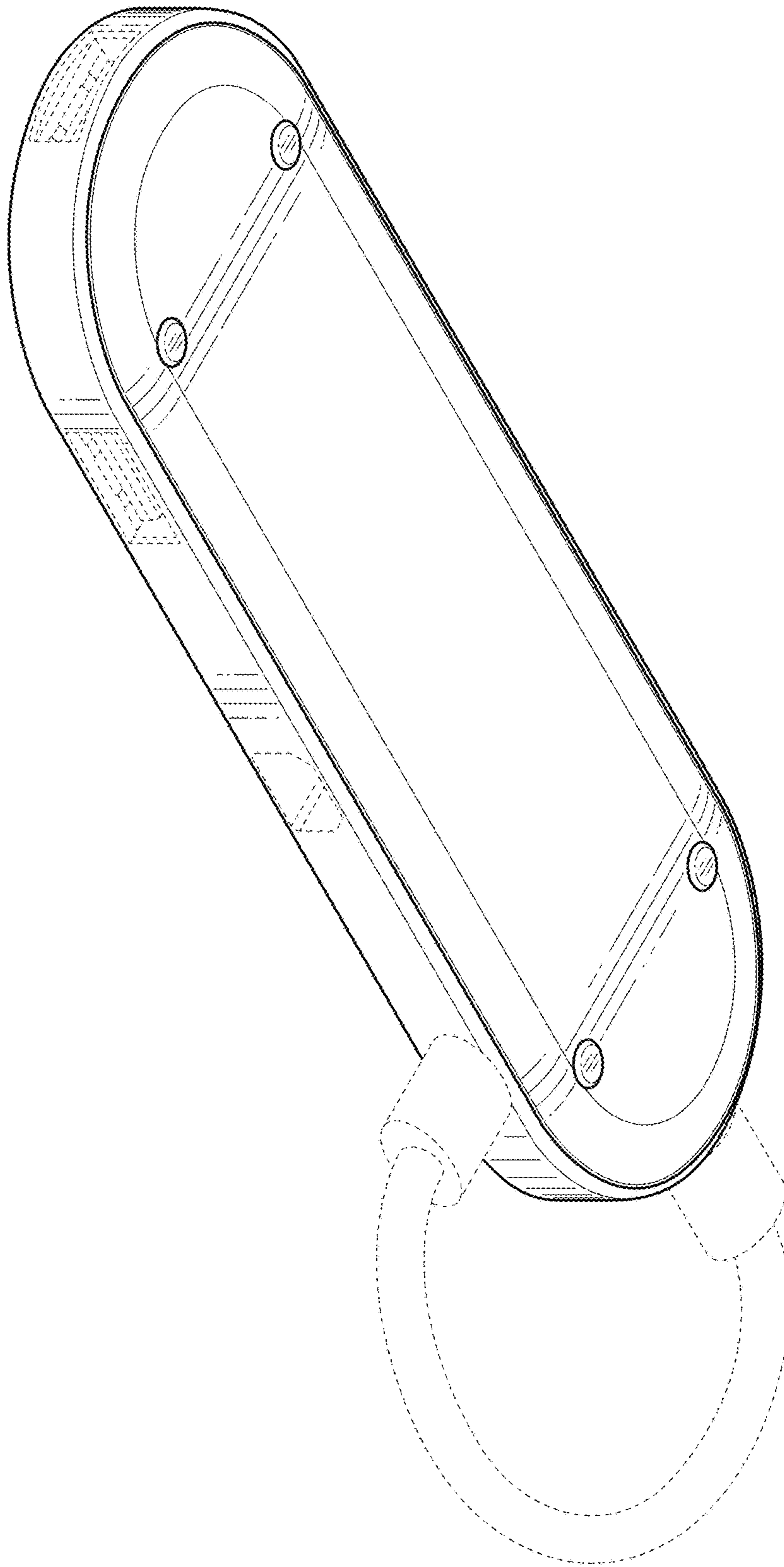

FIG. 2

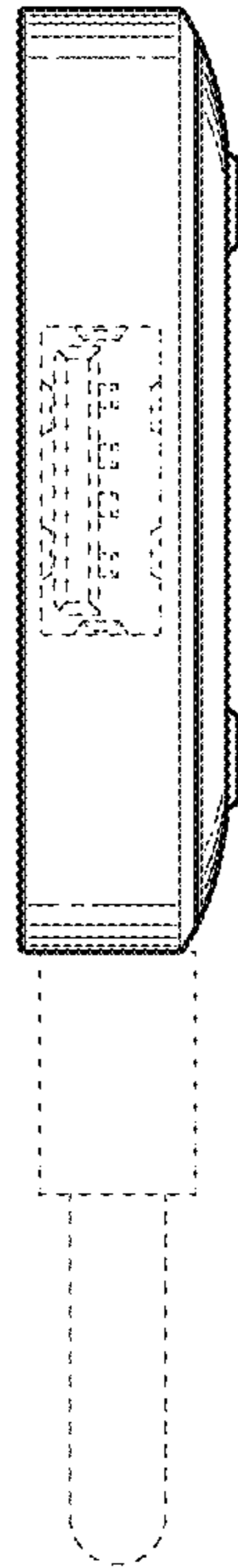

FIG. 3

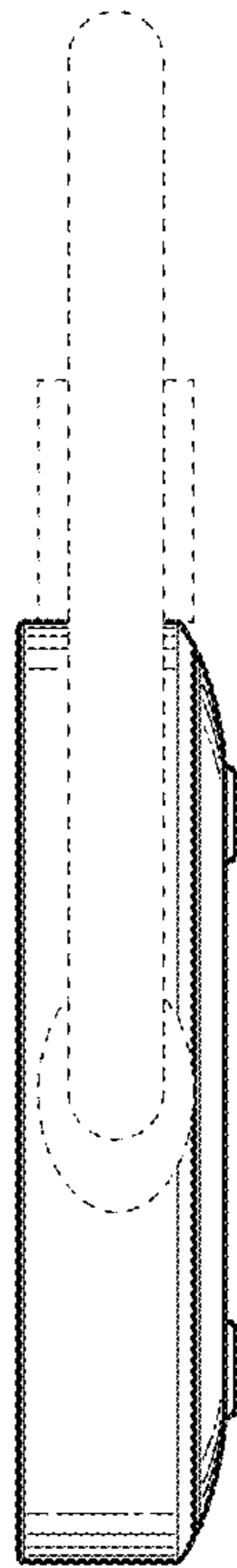

FIG. 4

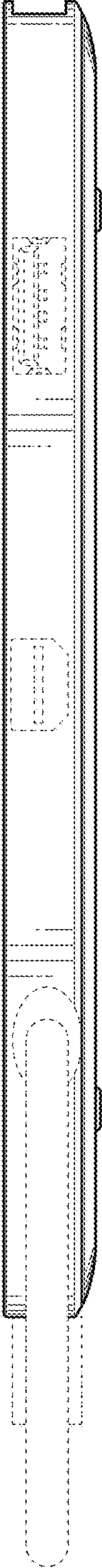

FIG. 5

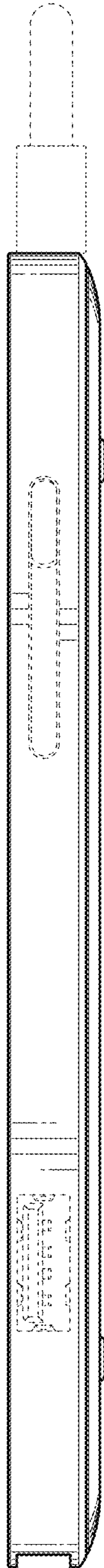

FIG. 6



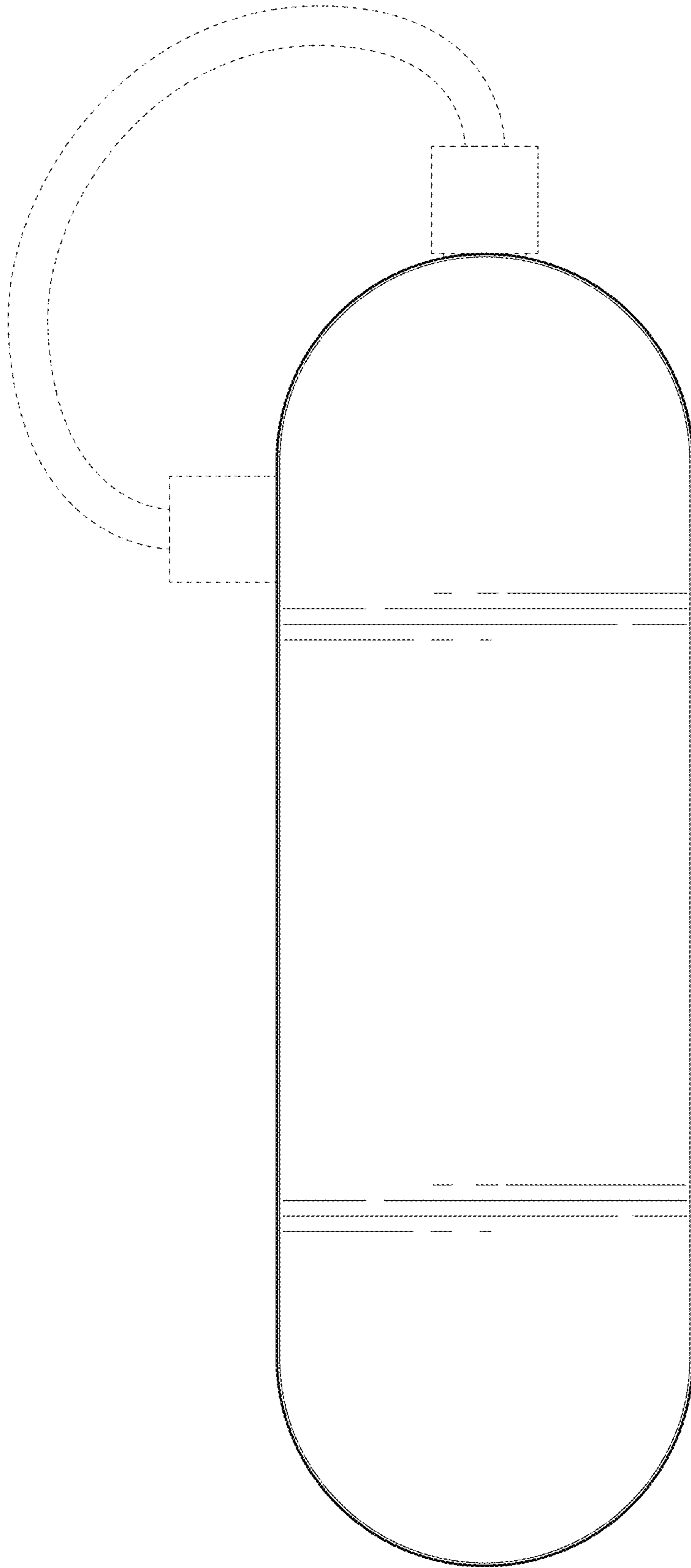

FIG. 7

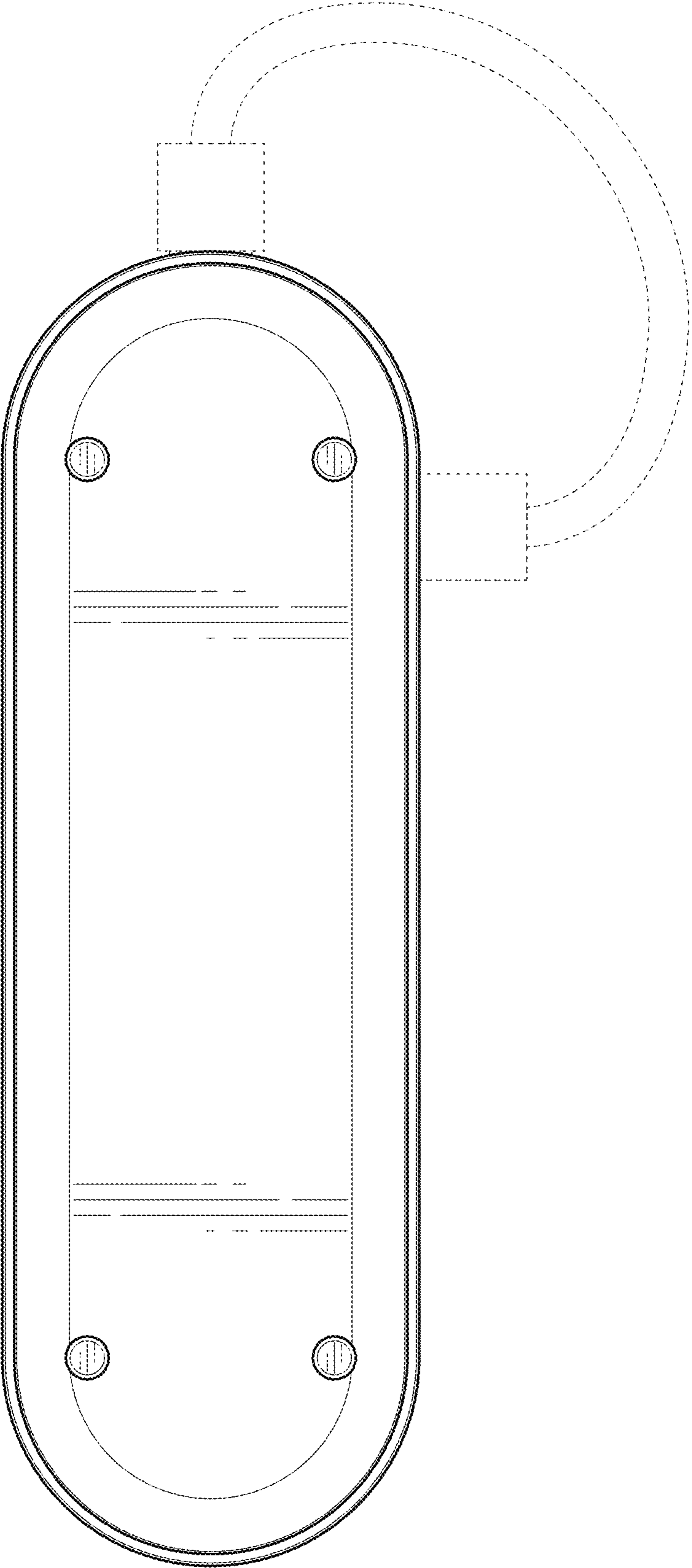

FIG. 8

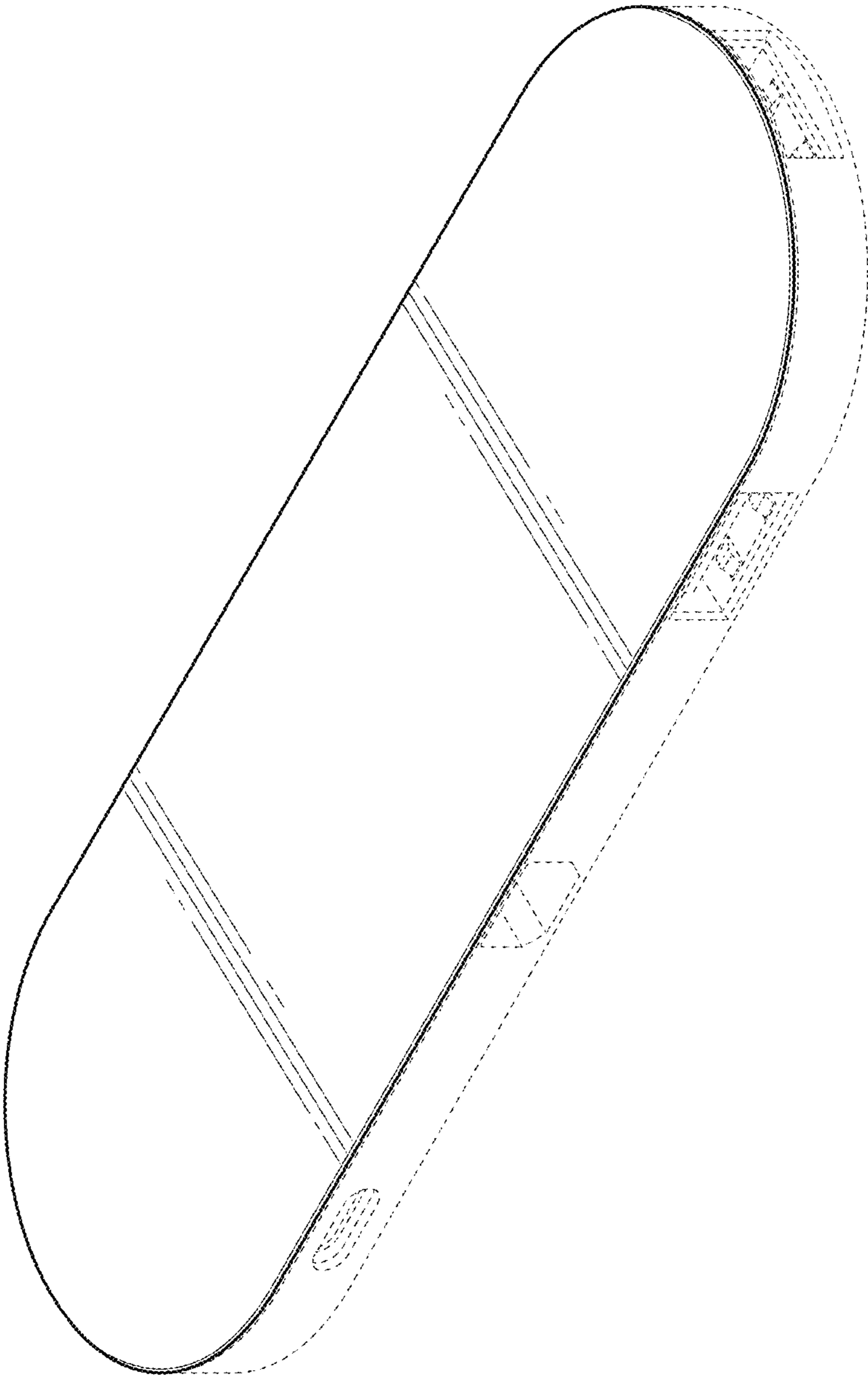

FIG. 9

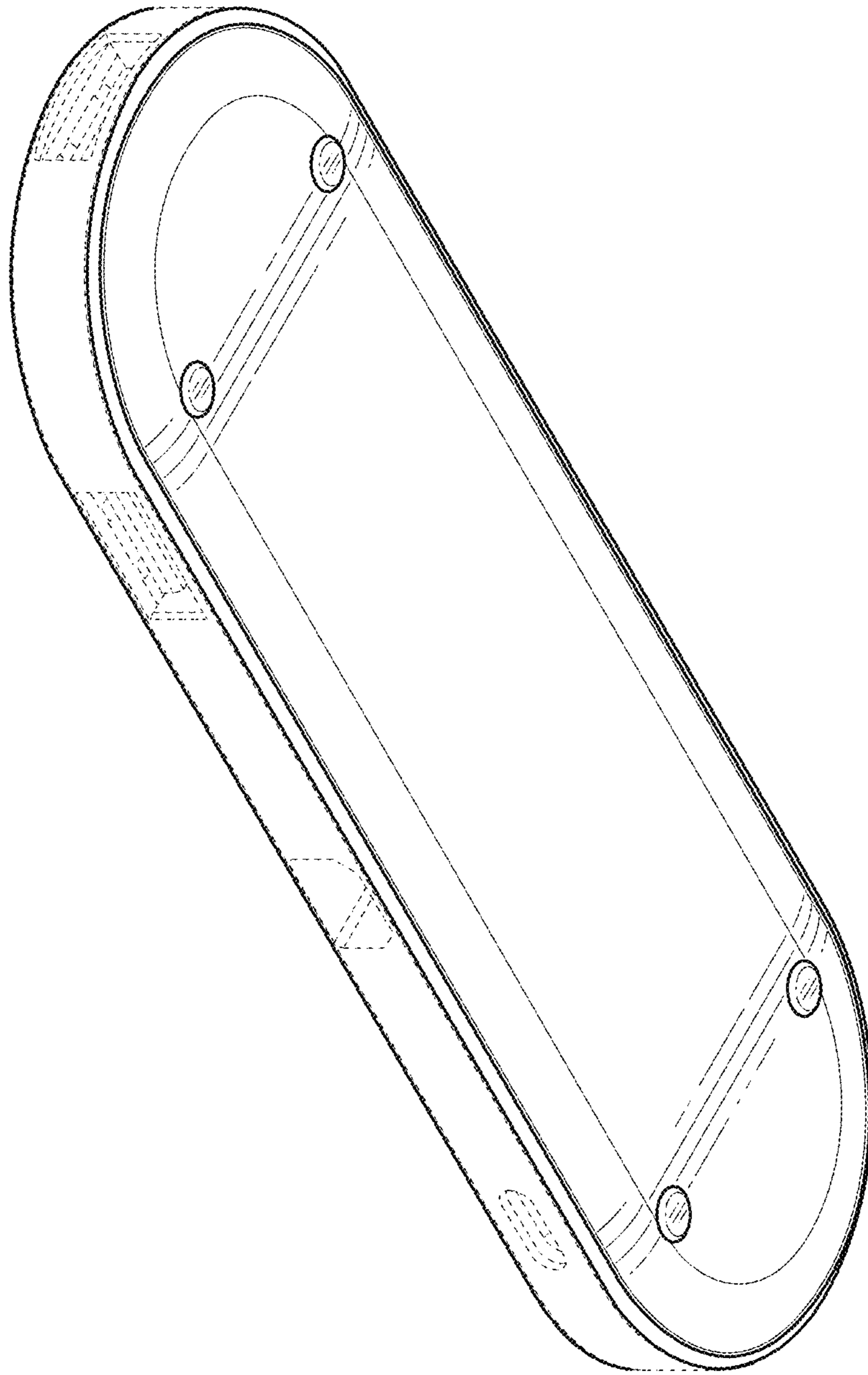

FIG. 10

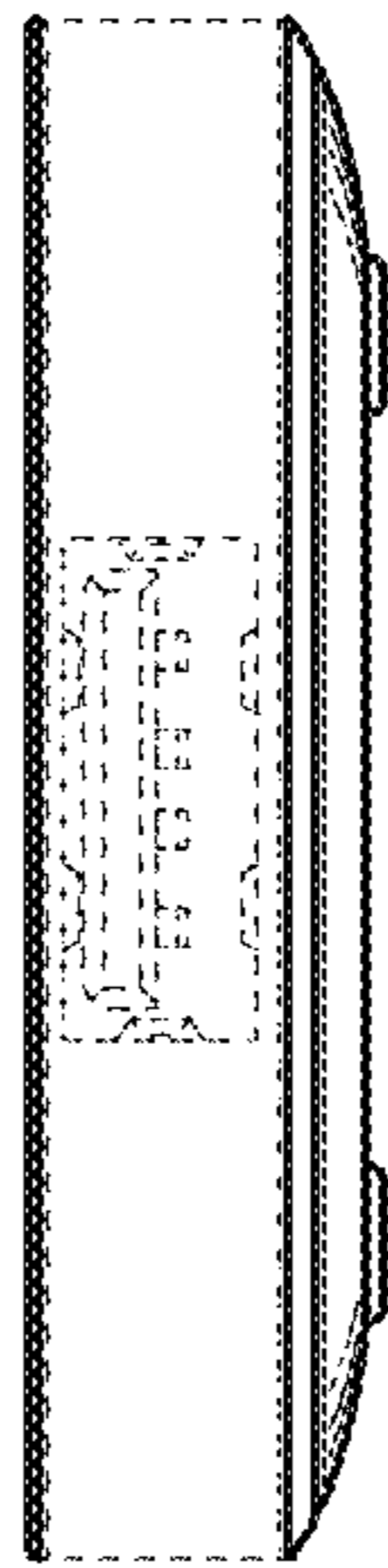

FIG. 11

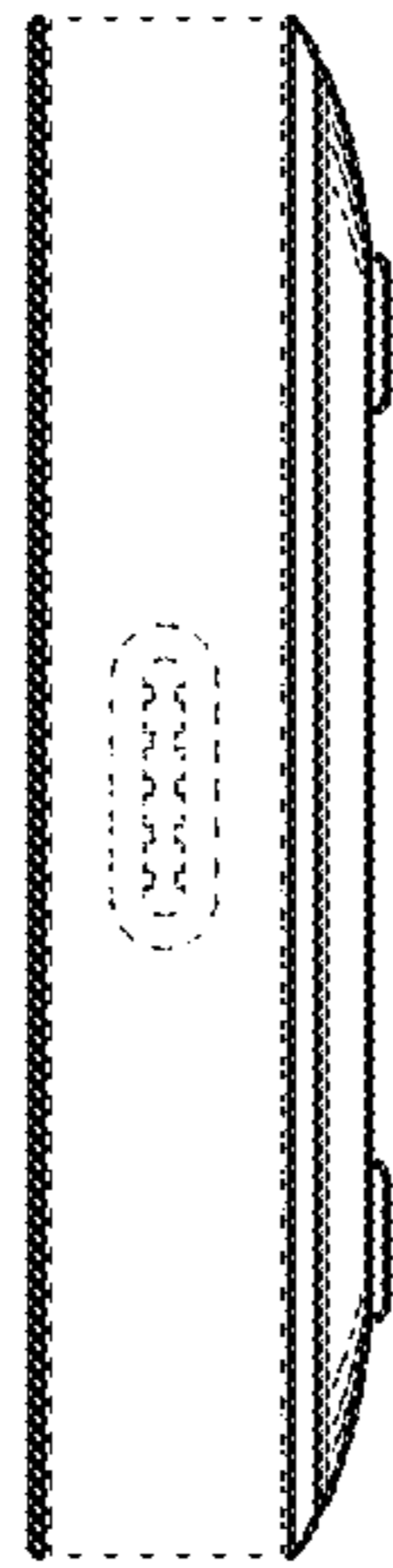

FIG. 12

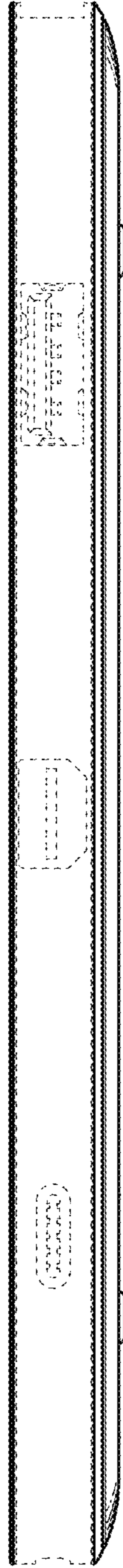

FIG. 13

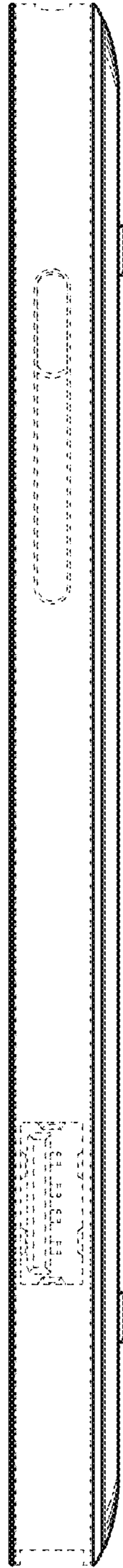

FIG. 14



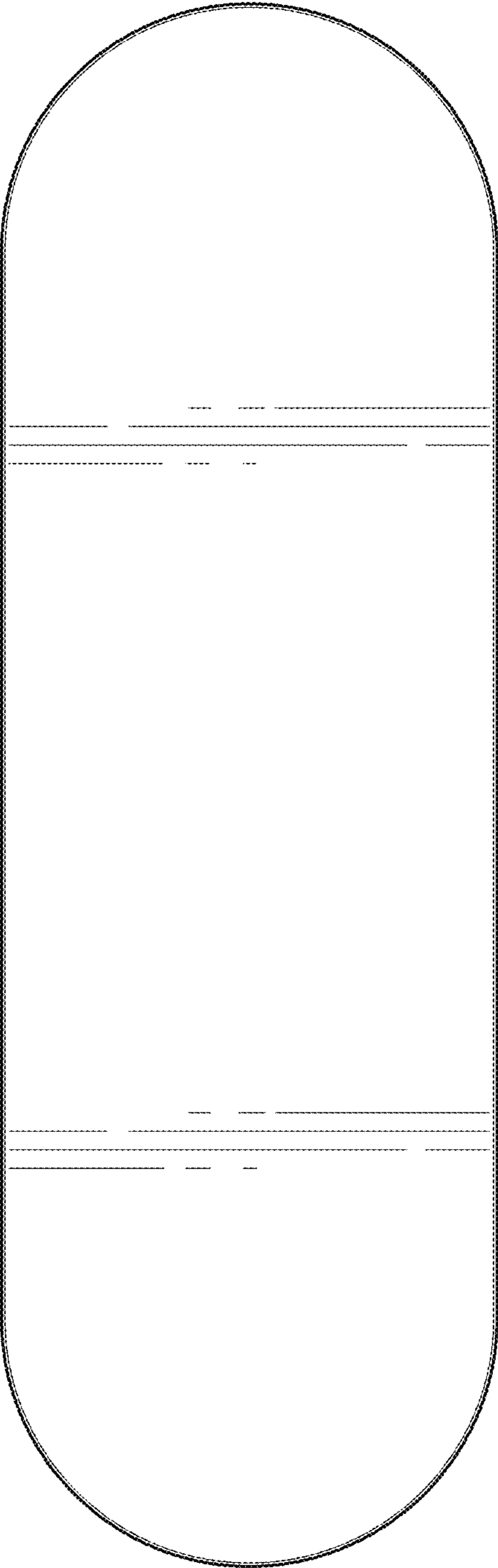

FIG. 15

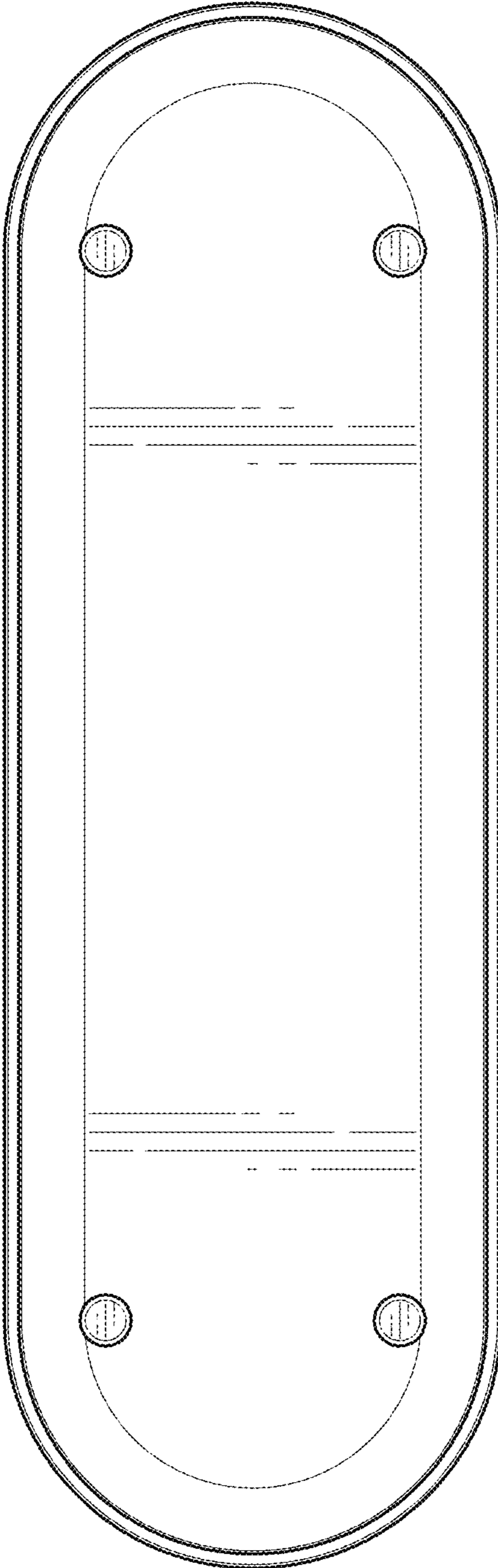

FIG. 16