

US00D836571S

(12) **United States Design Patent** (10) **Patent No.:** **US D836,571 S**
Ueda (45) **Date of Patent:** **** Dec. 25, 2018**

(54) **HEAT SINK**
(71) Applicant: **SAIJOINX Co., Ltd.**, Kyoto-shi (JP)
(72) Inventor: **Naoki Ueda**, Kyoto (JP)
(73) Assignee: **SAIJOINX Co., Ltd.**, Kyoto-shi (JP)
(**) Term: **15 Years**

8,879,261 B2 * 11/2014 Lee F28D 15/0275
165/104.21
D755,134 S * 5/2016 Andre D13/179
D762,181 S * 7/2016 Lin F21V 29/74
D13/179

(Continued)

(21) Appl. No.: **29/613,025**
(22) Filed: **Aug. 7, 2017**

(30) **Foreign Application Priority Data**

Feb. 15, 2017 (JP) 2017-002912

(51) **LOC (11) Cl.** **13-03**
(52) **U.S. Cl.**
USPC **D13/179**

(58) **Field of Classification Search**
USPC D13/179, 122, 182; D26/138, 141, 67,
D26/152
CPC .. H05K 7/20; H05K 7/20172; H05K 7/20127;
H05K 7/20336; H05K 7/202; H05K
7/20272; H01L 23/34; H01L 23/3672;
H01L 23/40; H01L 23/4006; H01L
23/4093; F28D 15/0208; F28D 15/04
See application file for complete search history.

(56) **References Cited**

U.S. PATENT DOCUMENTS

3,239,003 A * 3/1966 Boudette B21D 53/02
165/185
D427,946 S * 7/2000 Kuo-An D12/114
D478,556 S * 8/2003 Abdo D13/179
D568,829 S * 5/2008 Yamashita D13/179
D579,421 S * 10/2008 Chu D13/179
D593,042 S * 5/2009 Yamashita D13/179
D603,810 S * 11/2009 Yang D13/179
D677,636 S * 3/2013 Lee D13/179

OTHER PUBLICATIONS

Robinson Fin, "Plain Radial Aluminum". Accessed Jun. 6, 2018.
(<http://www.robfin.com/plain-folded-fins/plain-radial-aluminum-37/>).*

(Continued)

Primary Examiner — Jennifer Rivard
Assistant Examiner — April Rivas
(74) *Attorney, Agent, or Firm* — Locke Lord LLP

(57) **CLAIM**

The ornamental design for a heat sink, as shown and described.

DESCRIPTION

FIG. 1 is a front view of the heat sink, with a back view being the same;
FIG. 2 is a top plan view thereof, the bottom plan view being the same;
FIG. 3 is a right-side view thereof, with a left-side view being the same;
FIG. 4 is a cross-section view taken from line 4-4 in FIG. 1 thereof;
FIG. 5 is an enlarged partial view shown in FIG. 6, thereof;
FIG. 6 is a front view thereof; showing the section where FIG. 5 is taken within broken lines; and,
FIG. 7 is a top perspective view thereof.
The broken lines encircling a section of FIG. 6 are for indicating where the enlarged FIG. 5 view is taken. The broken lines in FIG. 5 illustrate the bounds of the enlarged segment of the view. None of the broken lines form part of the claimed design.

1 Claim, 7 Drawing Sheets

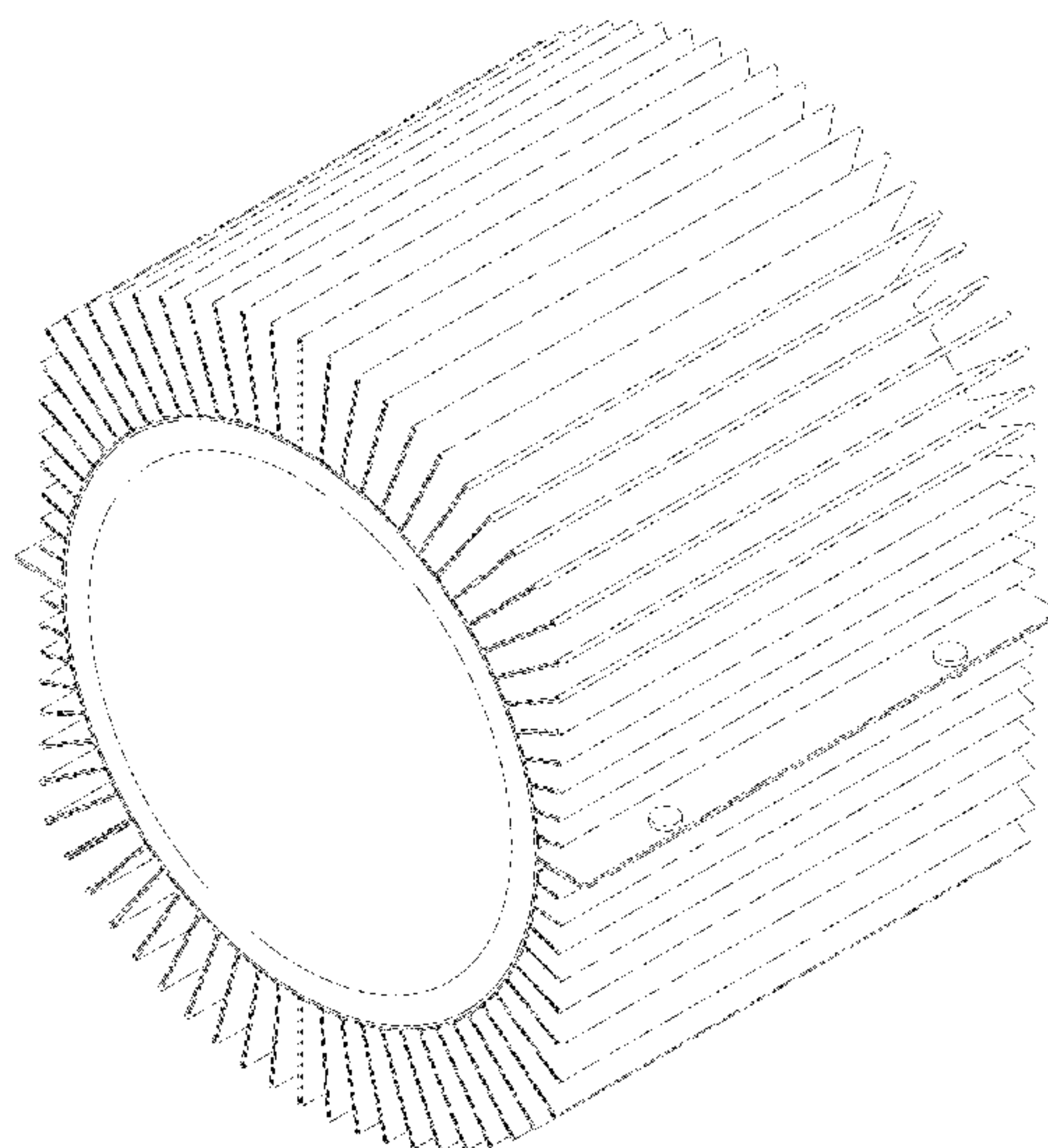

(56)

References Cited

U.S. PATENT DOCUMENTS

D795,808 S * 8/2017 Mayor D13/122
2002/0121365 A1 * 9/2002 Kozyra F28F 3/025
165/185
2009/0002995 A1 * 1/2009 Lee F21K 9/00
362/294
2012/0118536 A1 * 5/2012 Huang F21V 29/006
165/104.26

OTHER PUBLICATIONS

Saijo, "Folding Fin". Web Page archive date Jun. 10, 2016. (<https://web.archive.org/web/20160610131301/http://www.saijoinx.com/en/this/foldingfin/>).*

* cited by examiner

FIG. 1

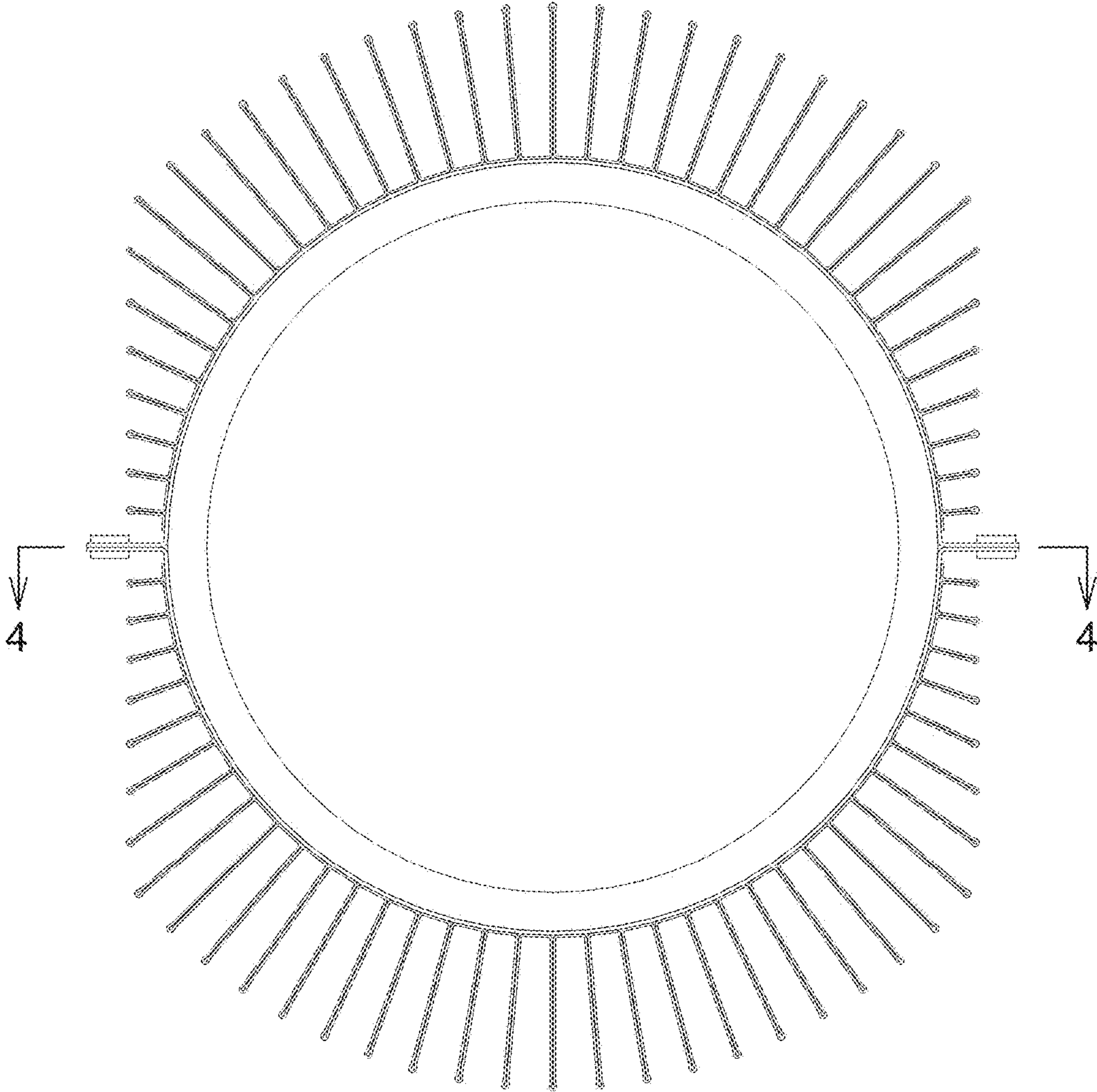

FIG. 2

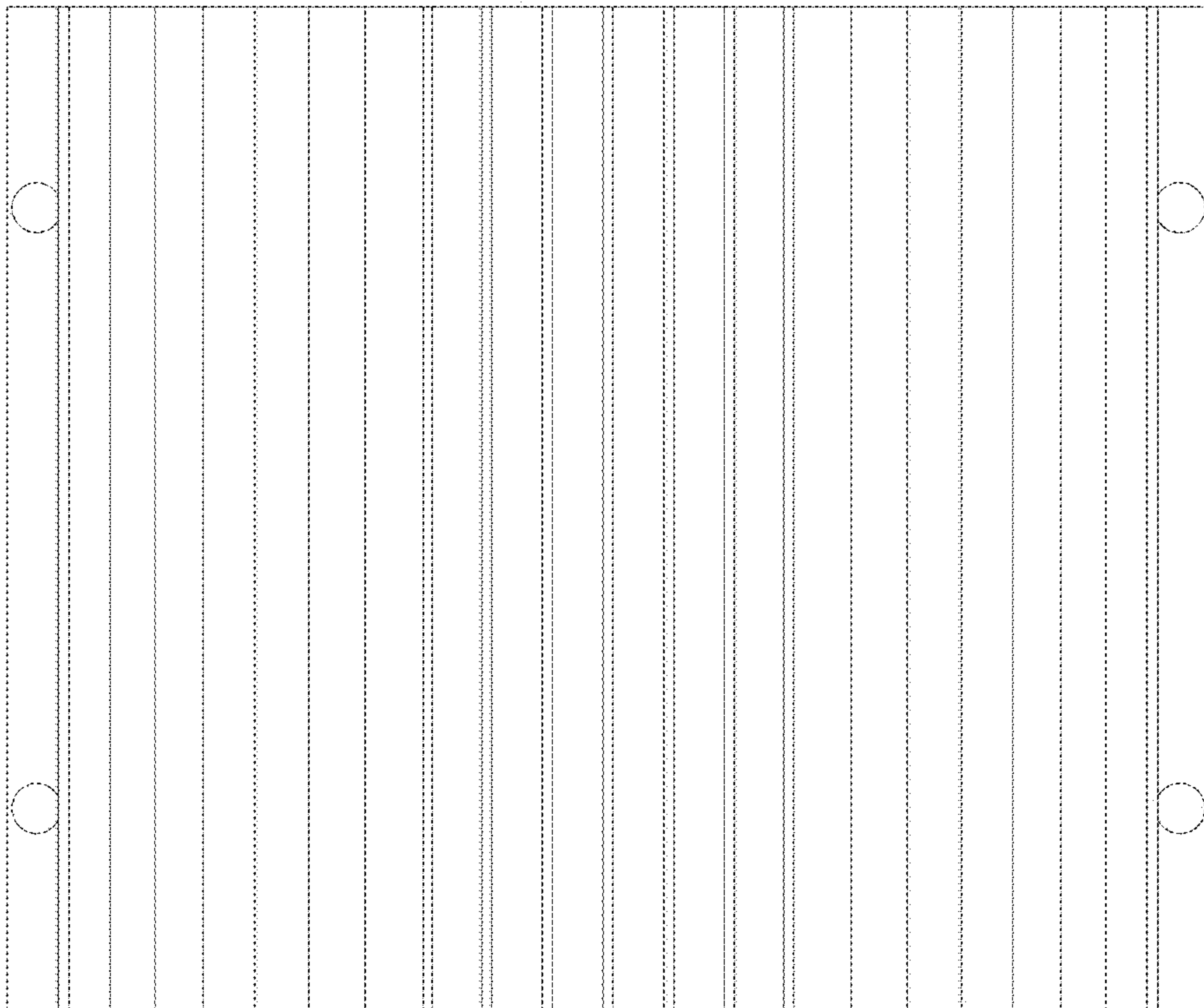

FIG. 3

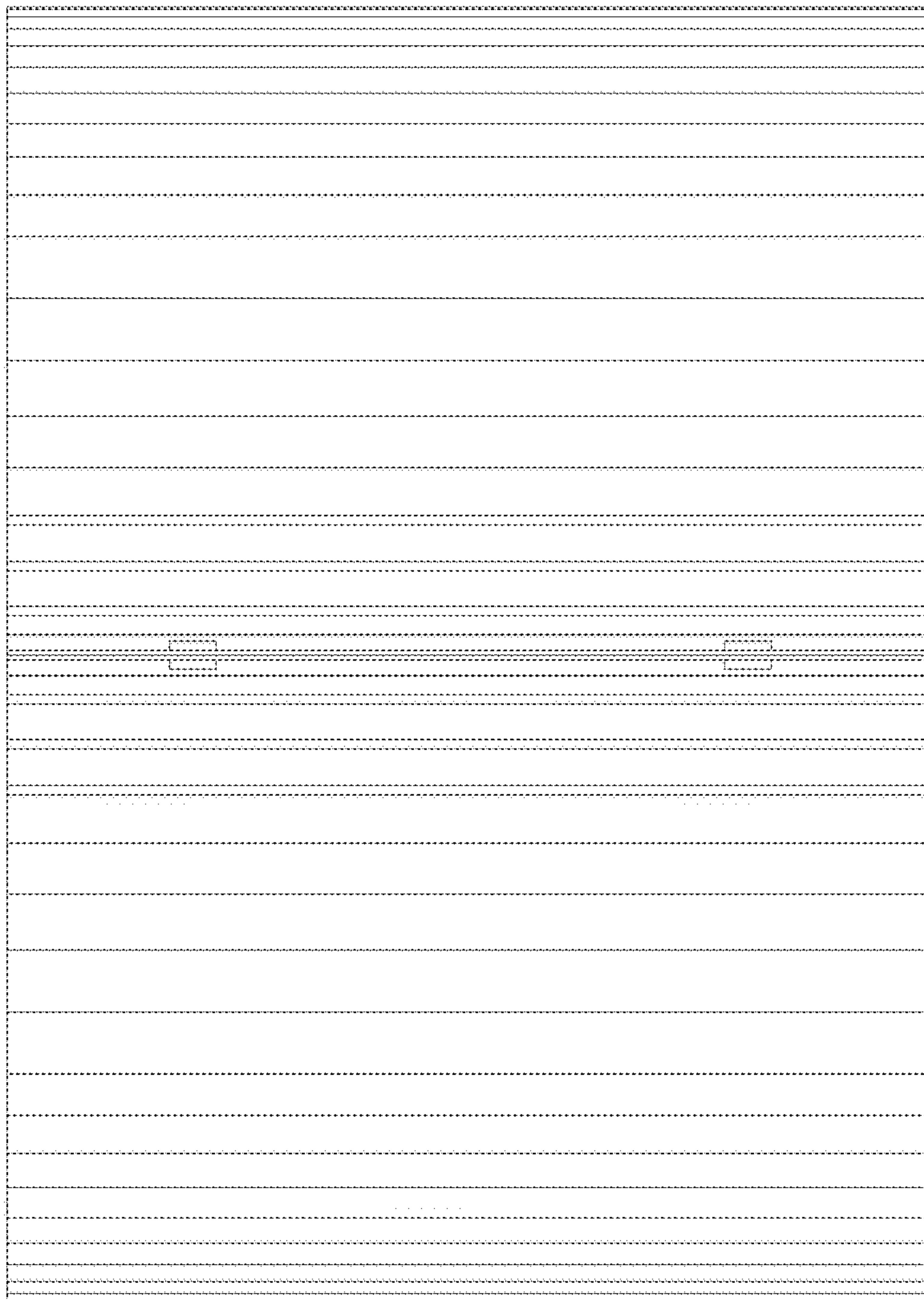

FIG. 4

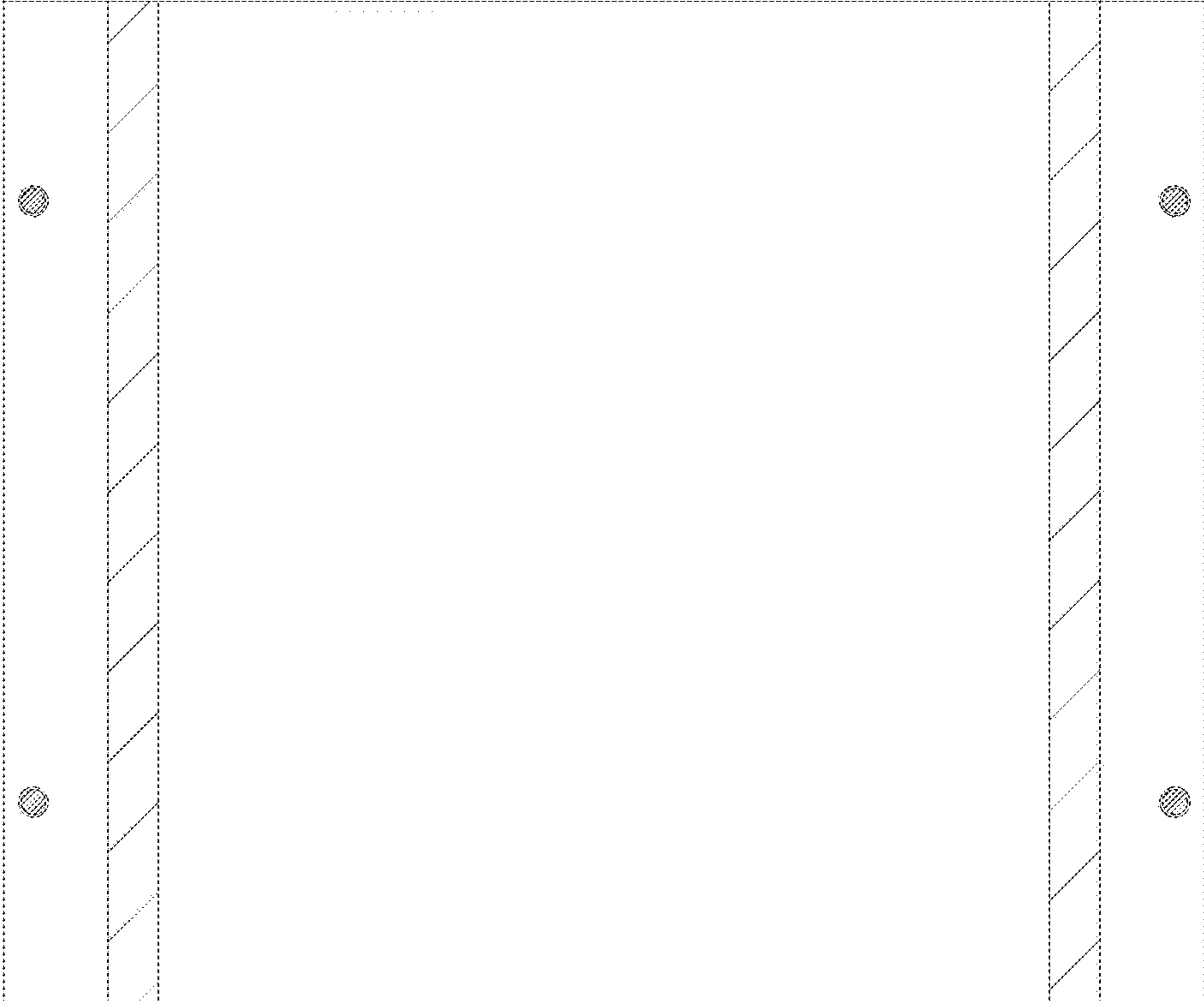

FIG. 5

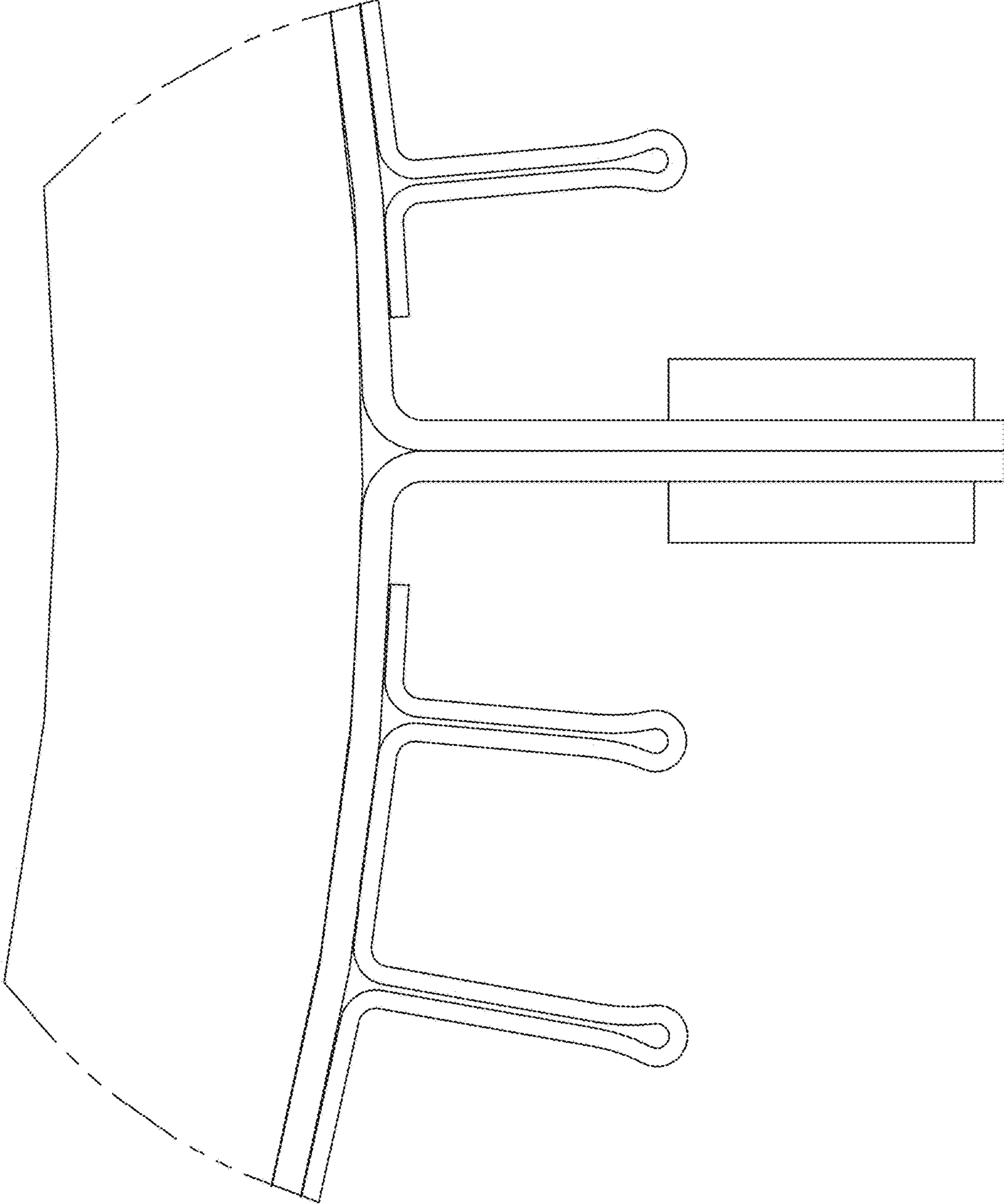

FIG. 6

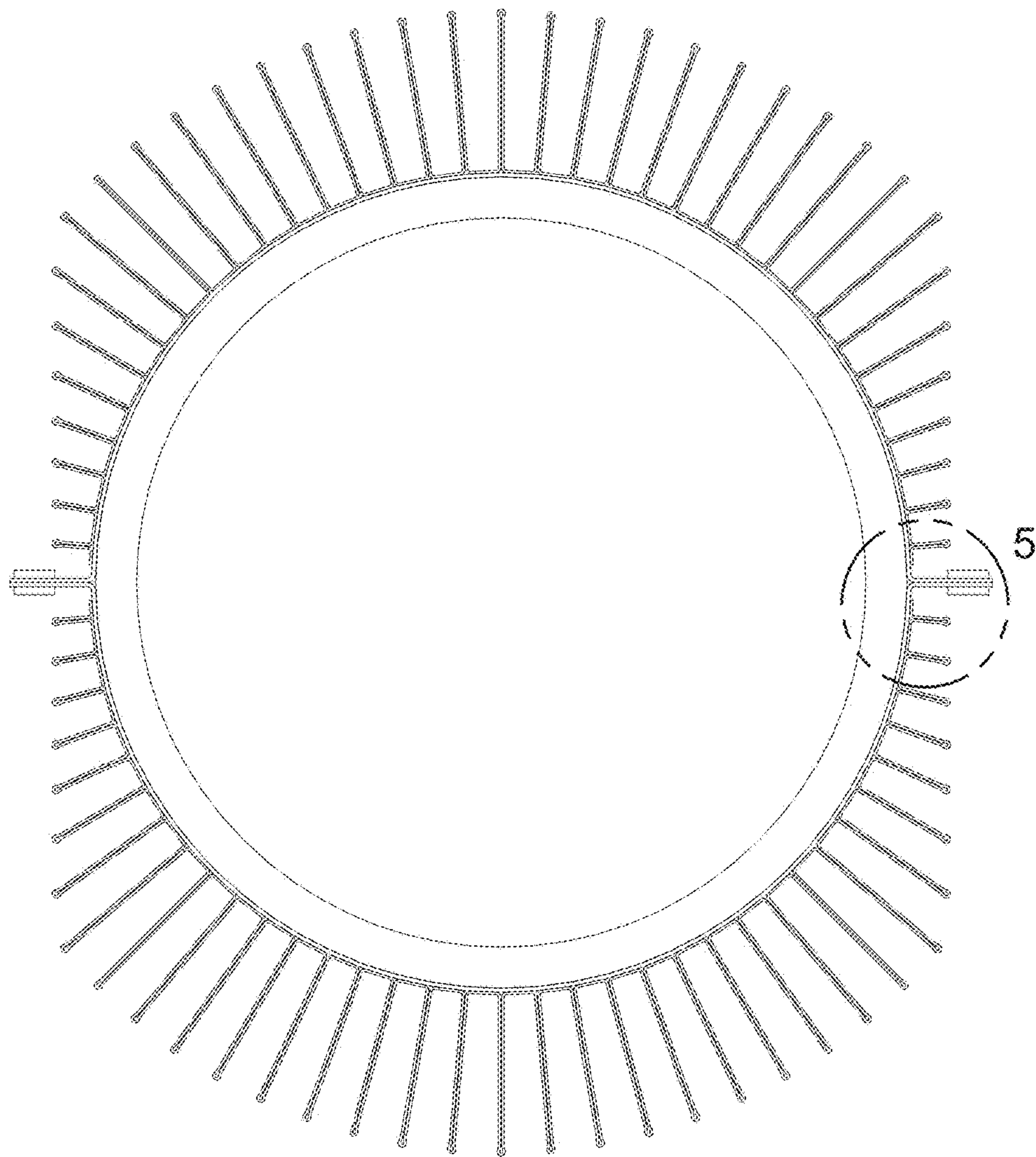

FIG. 7

