



US00D836532S

(12) **United States Design Patent** (10) **Patent No.:** **US D836,532 S**
King (45) **Date of Patent:** **** Dec. 25, 2018**

(54) **TRUCK CAMPER**

(57) **CLAIM**

(71) Applicant: **KIMBO CAMPERS LLC**,
Bellingham, WA (US)

I claim the ornamental design for a truck camper, as shown and described.

(72) Inventor: **Mark King**, Bellingham, WA (US)

DESCRIPTION

(73) Assignee: **KIMBO CAMPERS LLC**,
Bellingham, WA (US)

A portion of the disclosure of this patent document contains material to which a claim for copyright is made. The copyright owner has no objection to the reproduction of the patent document or the patent disclosure, as it appears in the U.S. Patent Office records, but reserves all other copyright rights whatsoever.

(**) Term: **15 Years**

(21) Appl. No.: **29/608,586**

FIG. 1 is a front, left perspective view of a first embodiment of a truck camper, according to my design;

(22) Filed: **Jun. 22, 2017**

FIG. 2 is a front view of the truck camper of FIG. 1;

(51) **LOC (11) Cl.** **12-16**

FIG. 3 is a left side view of the truck camper of FIG. 1;

(52) **U.S. Cl.**
USPC **D12/404**

FIG. 4 is a right side view of the truck camper of FIG. 1;

(58) **Field of Classification Search**
USPC D12/401–405
CPC A47D 15/00; A47C 7/66; A47C 31/00;
A47G 9/068

FIG. 5 is a rear view of the truck camper of FIG. 1;

See application file for complete search history.

FIG. 6 is a top view of the truck camper of FIG. 1;

FIG. 7 is a bottom view of the truck camper of FIG. 1;

FIG. 8 is a rear, left side perspective view of the truck camper of FIG. 1;

FIG. 9 is a top, left side perspective view of the truck camper of FIG. 1;

(56) **References Cited**

U.S. PATENT DOCUMENTS

FIG. 10 is a front, left side perspective view of a second embodiment of a truck camper, showing my new design;

D388,049 S *	12/1997	Reardon	D12/403
D431,225 S *	9/2000	Perlman	D12/404
D444,445 S *	7/2001	Schroeder	D12/404
D454,328 S *	3/2002	Cornelius	D12/404
D464,606 S *	10/2002	Soldatelli	D12/404
D489,673 S *	5/2004	Block	D12/404
D610,067 S *	2/2010	Frankham	D12/404
D619,077 S *	7/2010	Frankham	D12/404
D619,078 S *	7/2010	Frankham	D12/404

FIG. 11 is a front view of the truck camper of FIG. 10;

FIG. 12 is a left side view of the truck camper of FIG. 10;

FIG. 13 is a right side view of the truck camper of FIG. 10;

FIG. 14 is a rear view of the truck camper of FIG. 10;

FIG. 15 is a top view of the truck camper of FIG. 10;

FIG. 16 is a bottom view of the truck camper of FIG. 10;

FIG. 17 is a rear, left side perspective view of the truck camper of FIG. 10; and,

FIG. 18 is a top, left side perspective view of the truck camper of FIG. 10.

(Continued)

The broken lines shown in the drawings illustrate portions of the truck camper that form no part of the claimed design.

Primary Examiner — Katrina A Betton

(74) *Attorney, Agent, or Firm* — Fisherbroyles, LLP;
Jason M. Pass

1 Claim, 18 Drawing Sheets

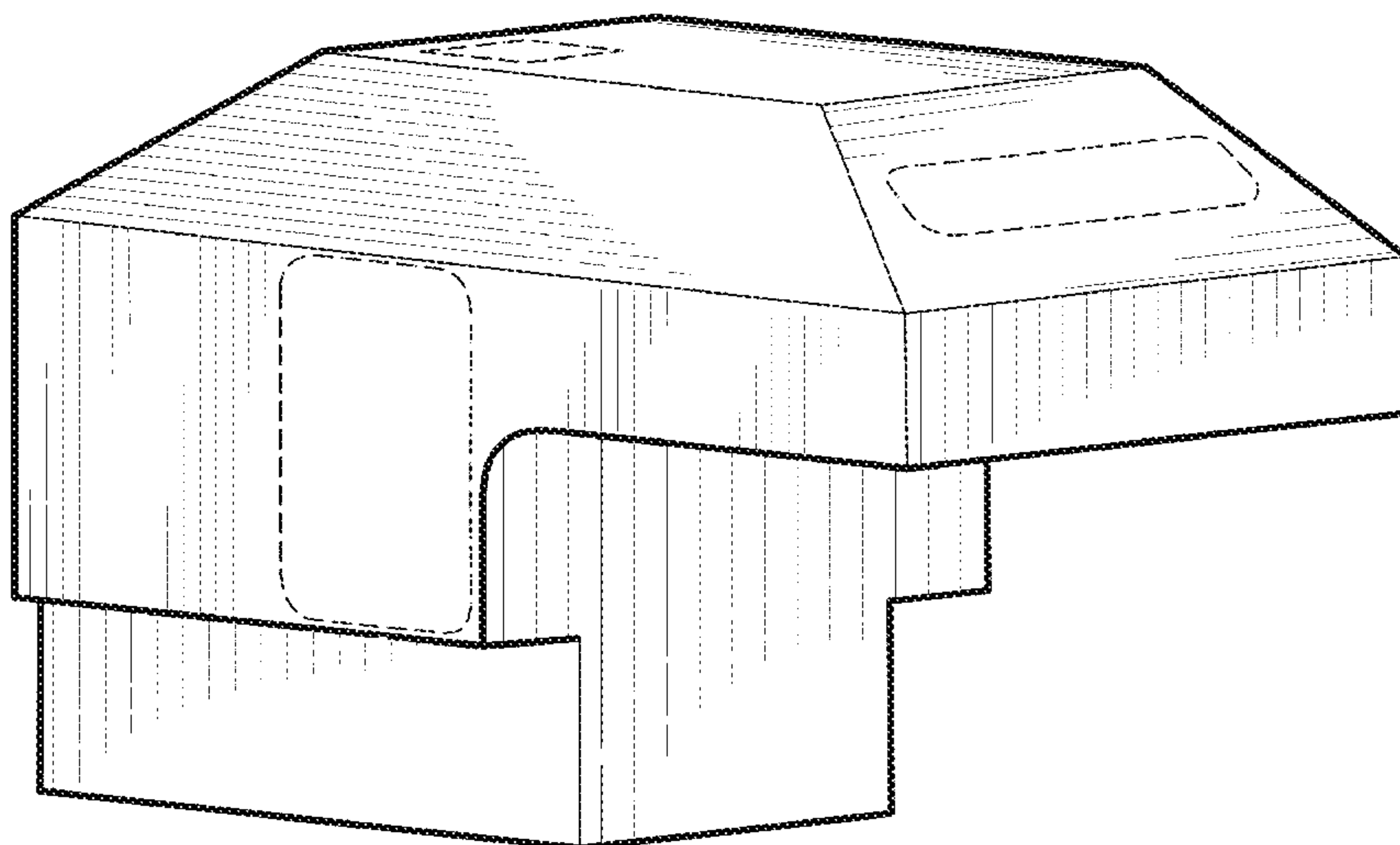

(56)

References Cited

U.S. PATENT DOCUMENTS

D748,038 S * 1/2016 Bennett D12/404
D812,545 S * 3/2018 Donohoe D12/404

* cited by examiner

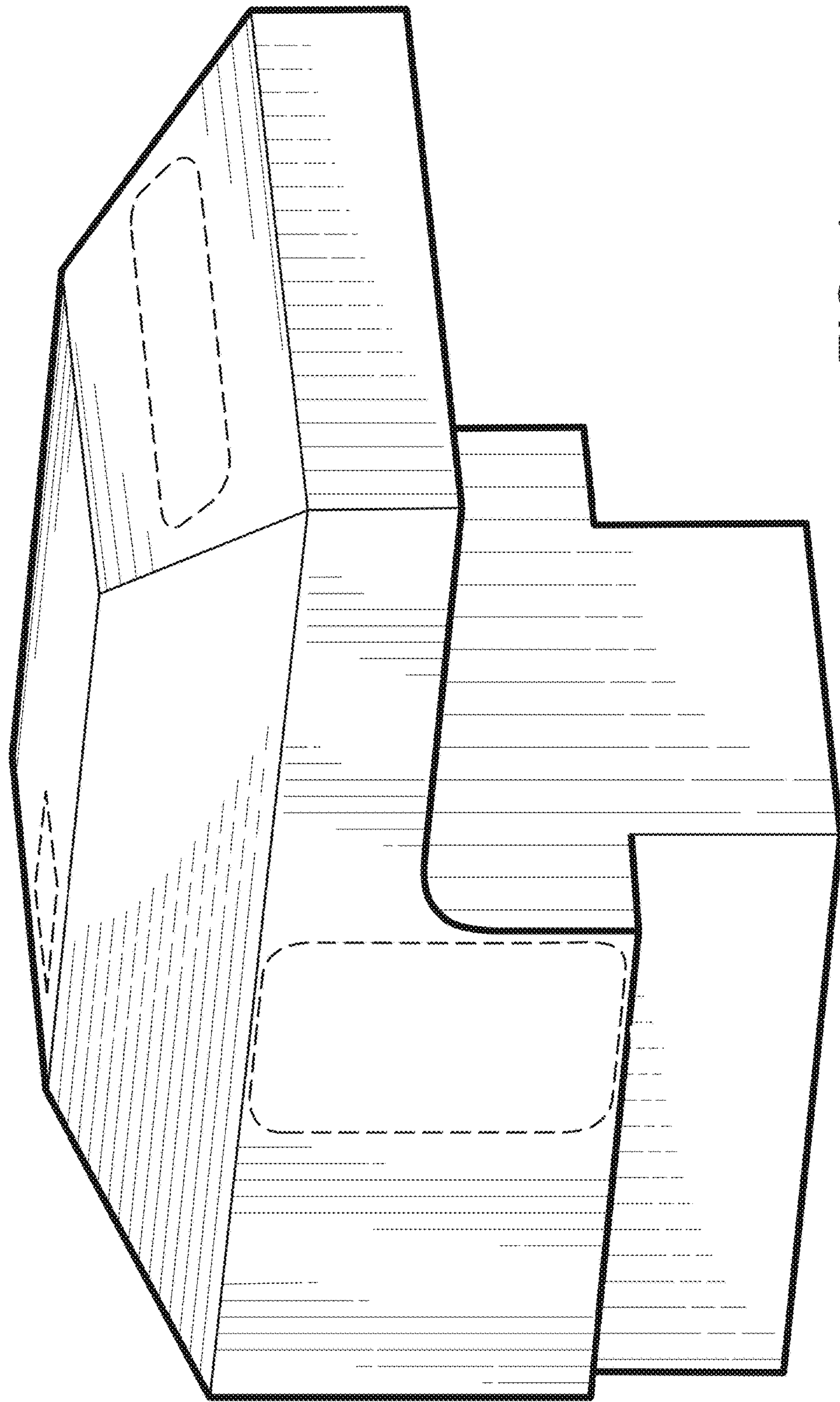
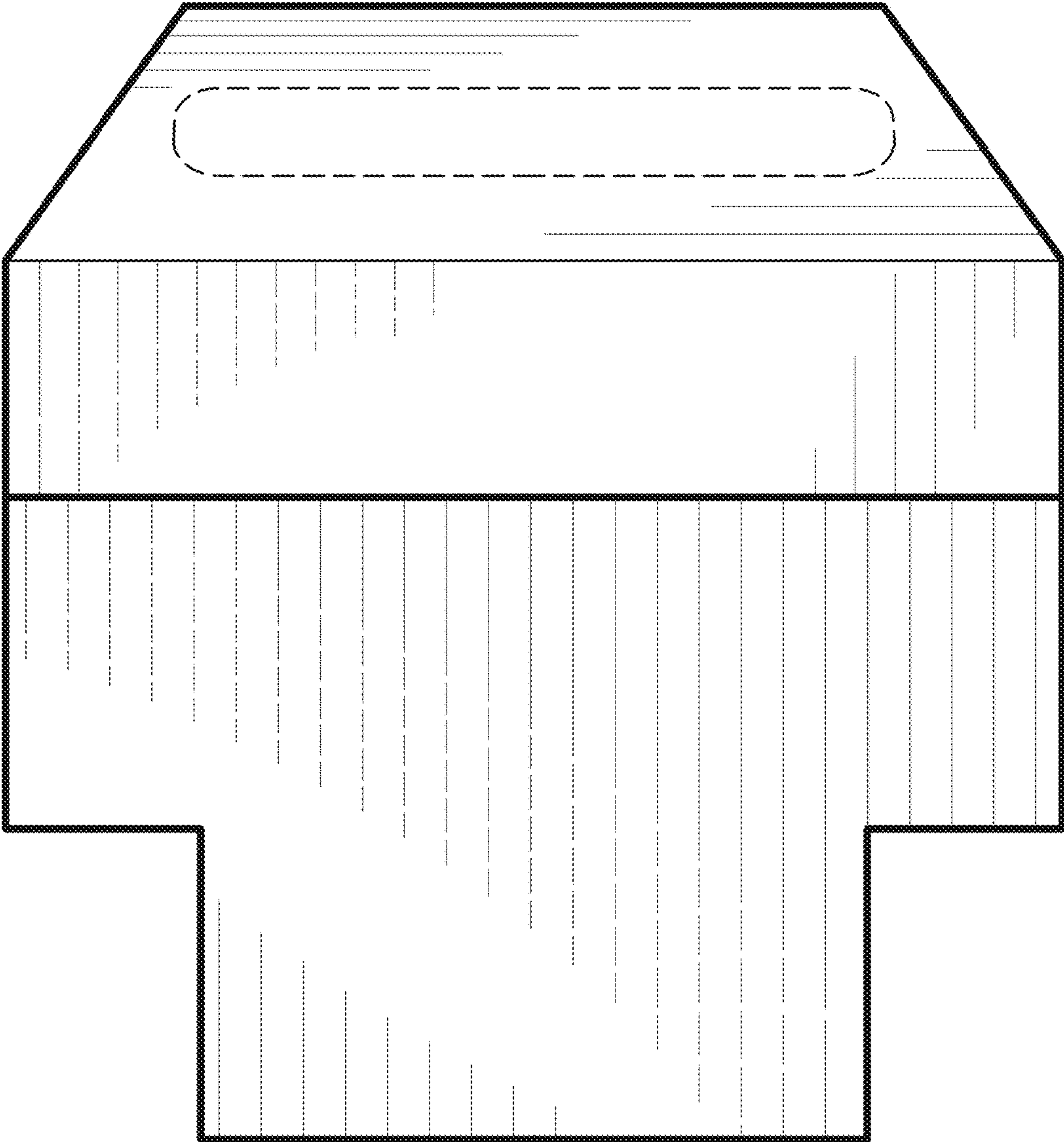

FIG. 1

© 2017 Kimbo Campers LLC



© 2017 Kimbo Campers LLC

FIG. 2

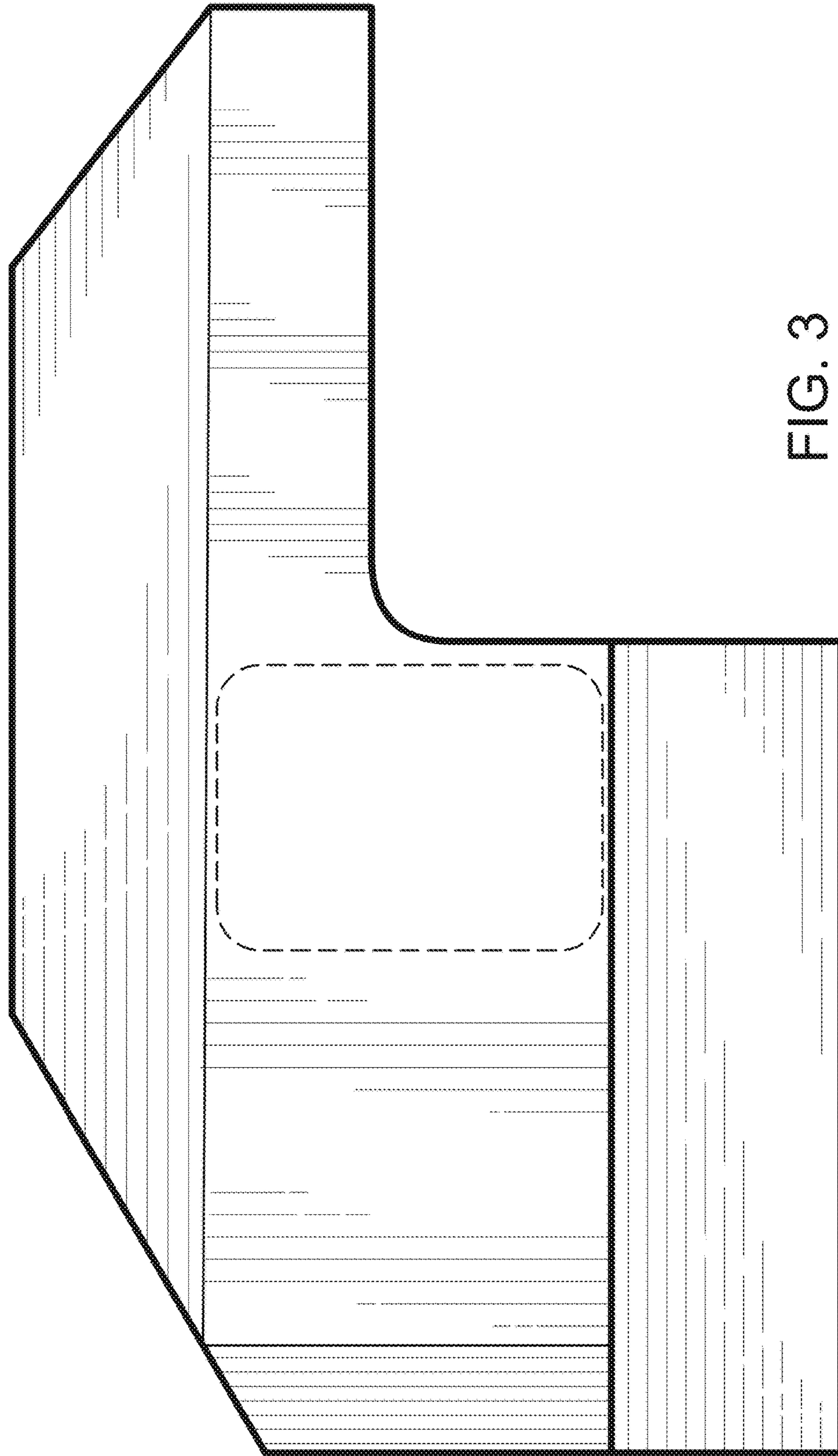

FIG. 3

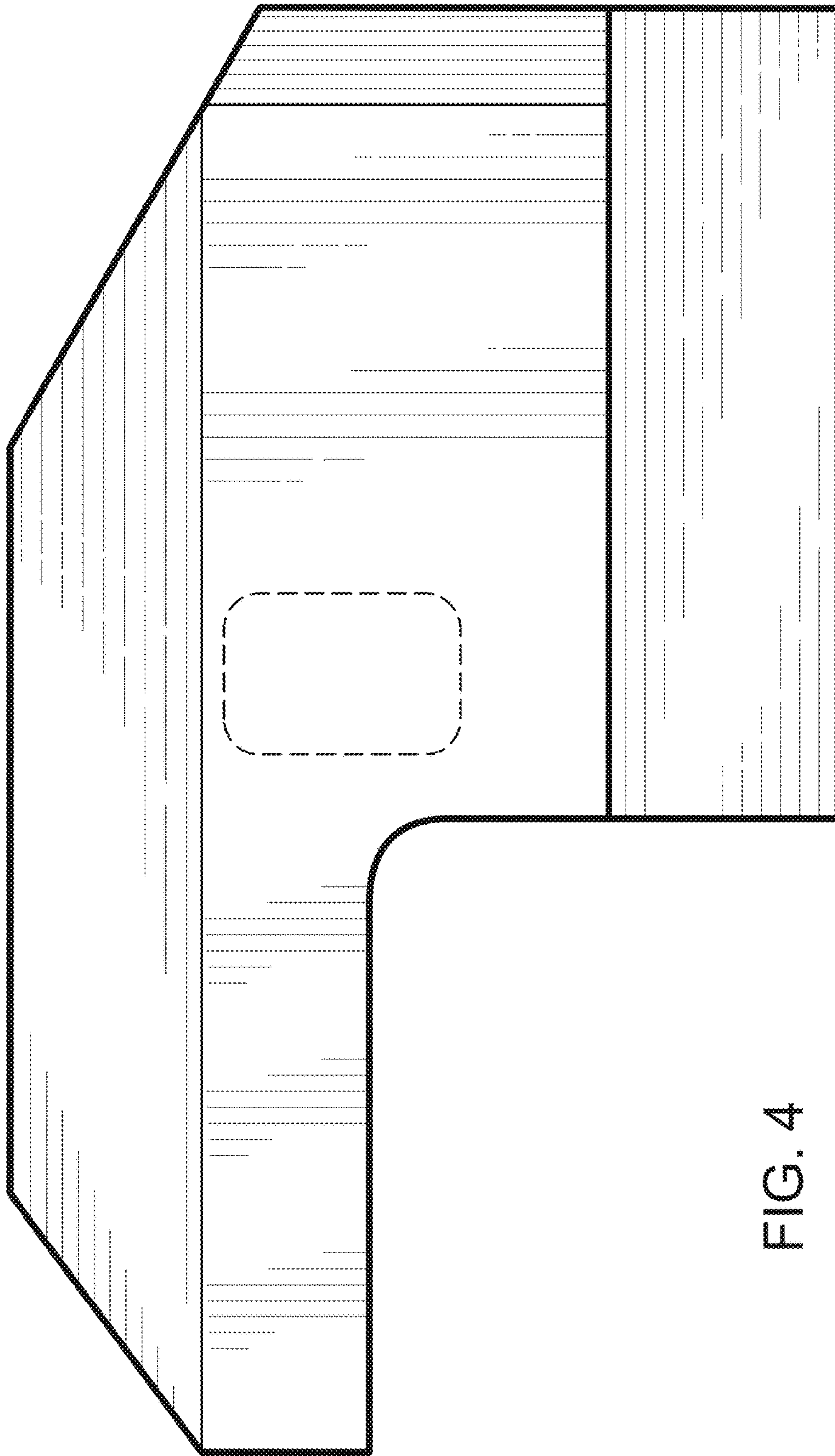
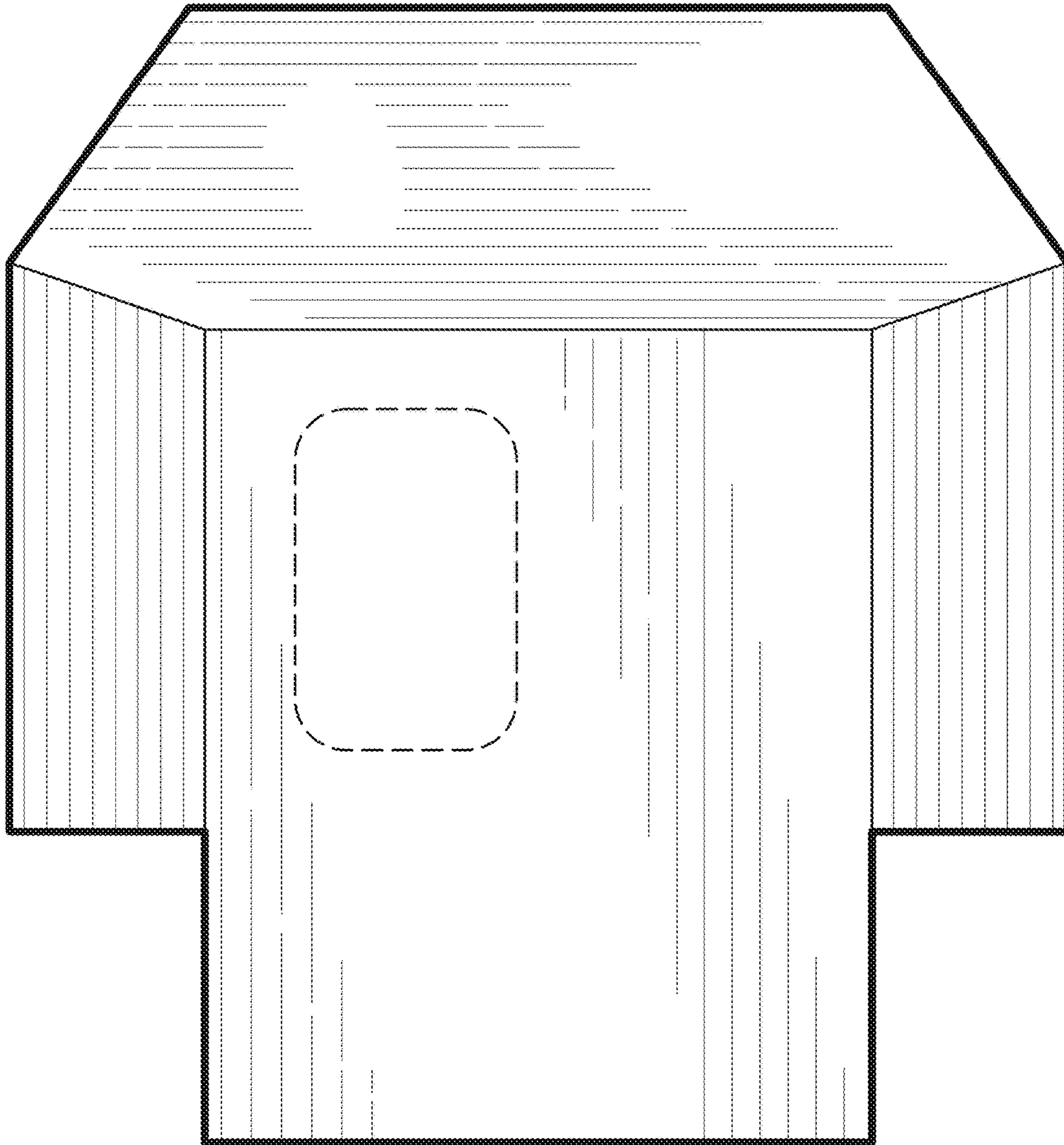

FIG. 4

© 2017 Kimbo Campers LLC



© 2017 Kimbo Campers LLC

FIG. 5

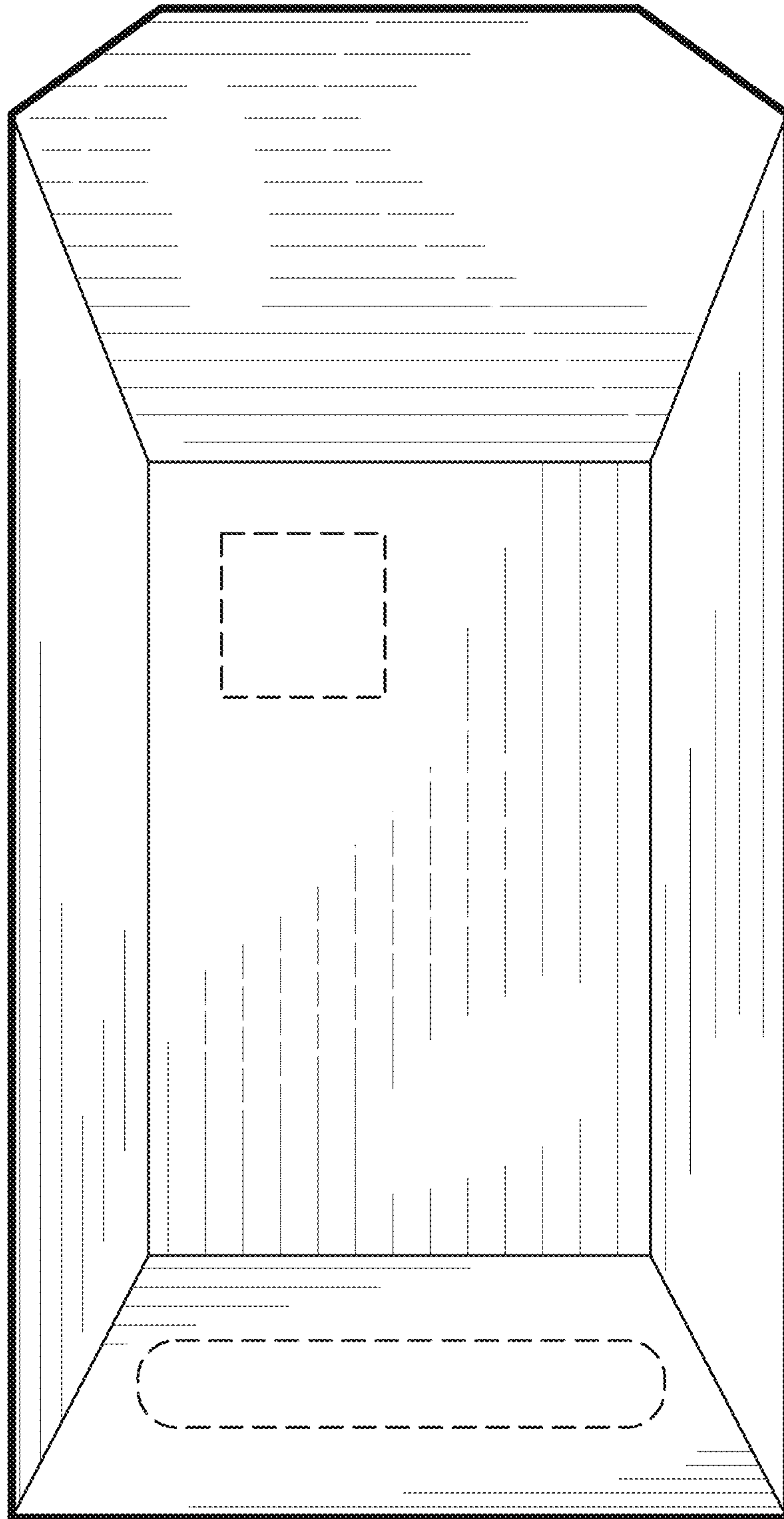

© 2017 Kimbo Campers LLC

FIG. 6

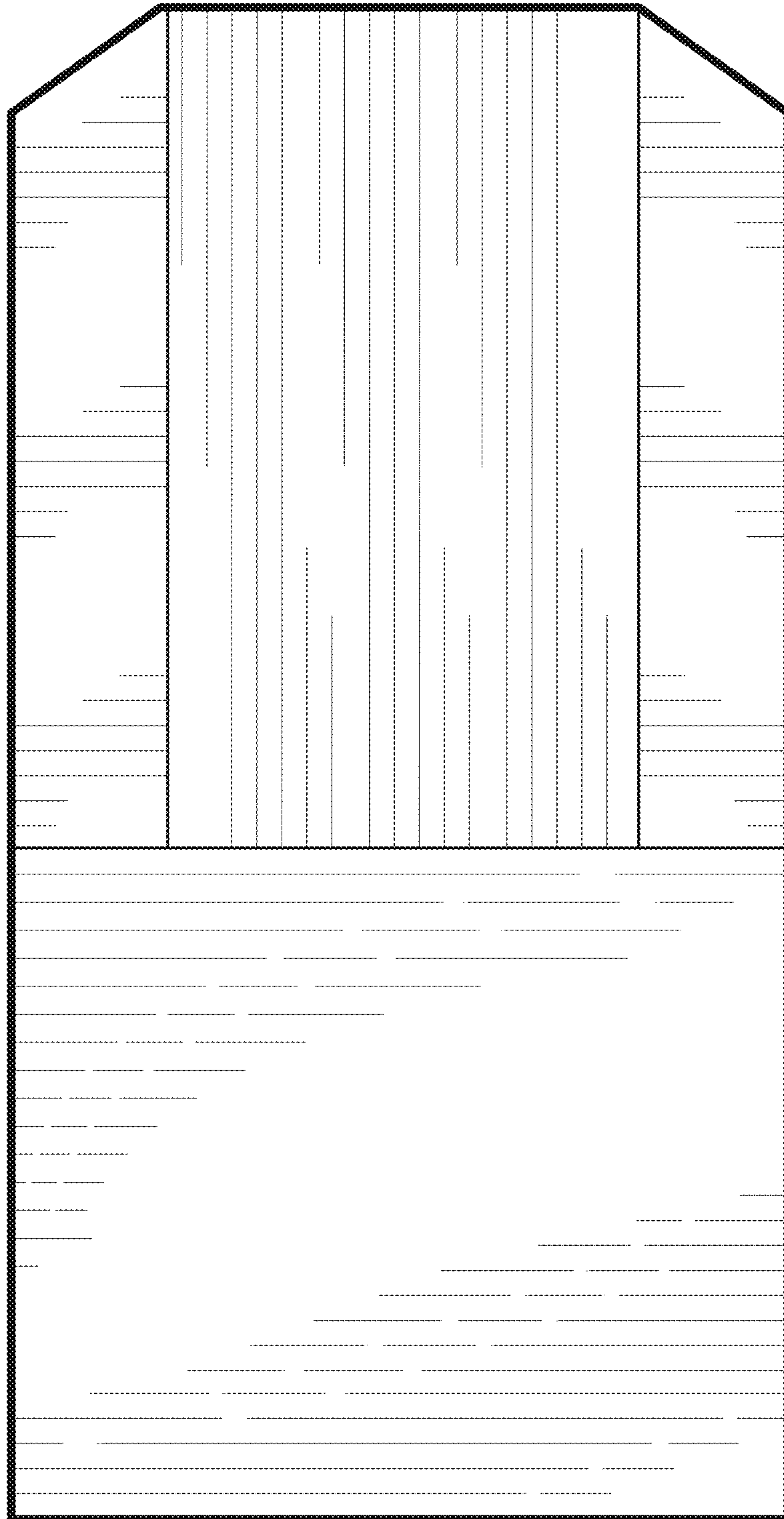

© 2017 Kimbo Campers LLC

FIG. 7

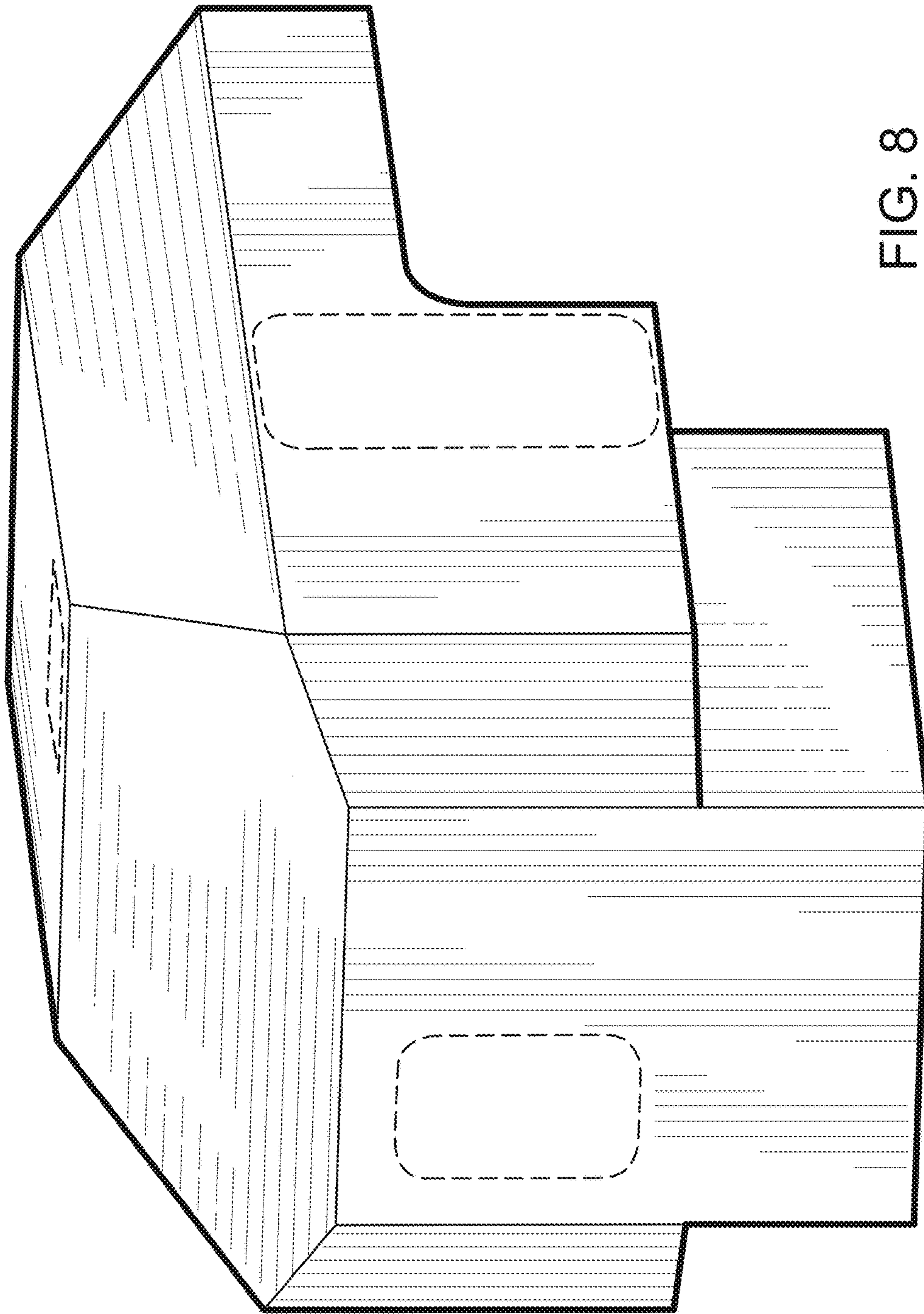

FIG. 8

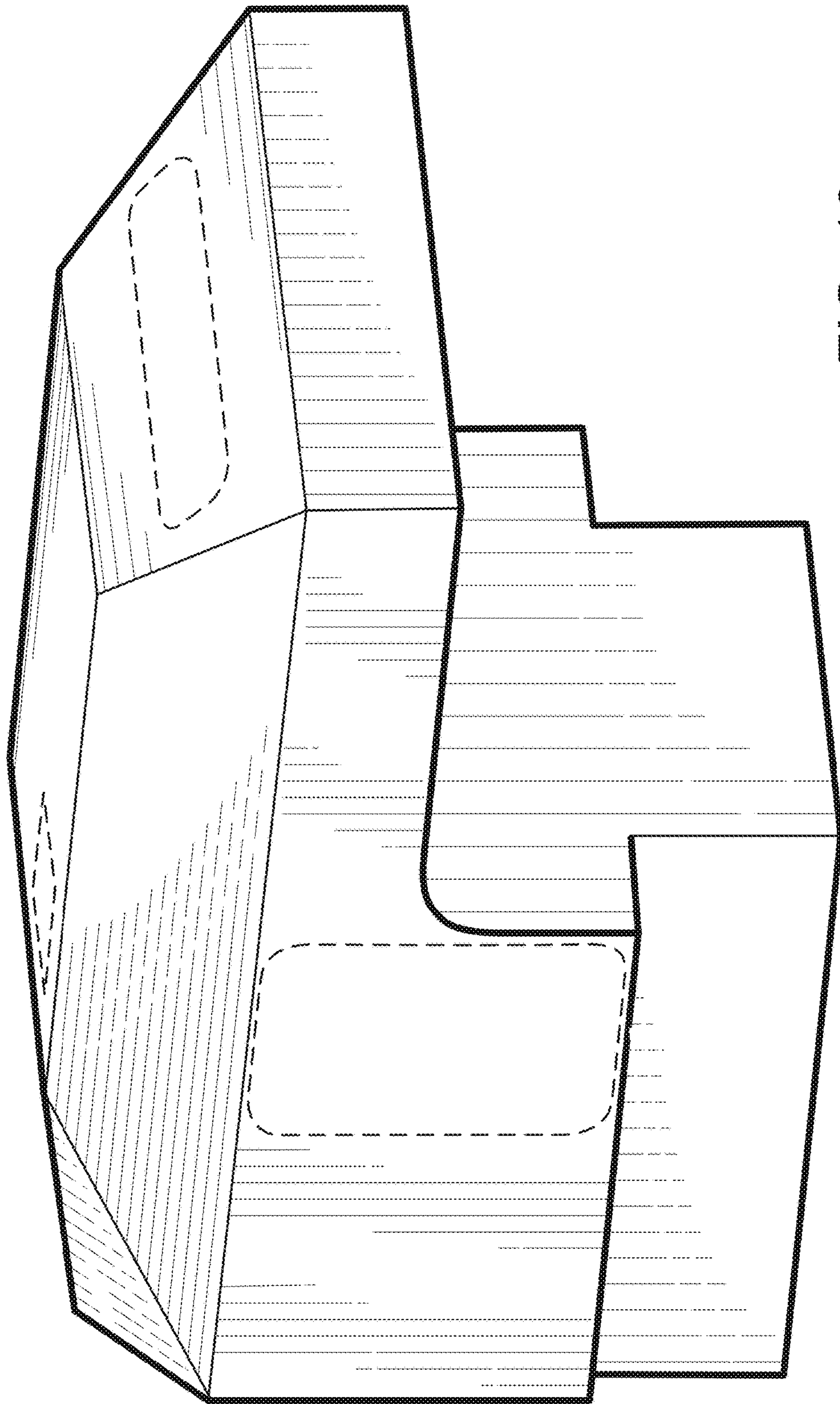
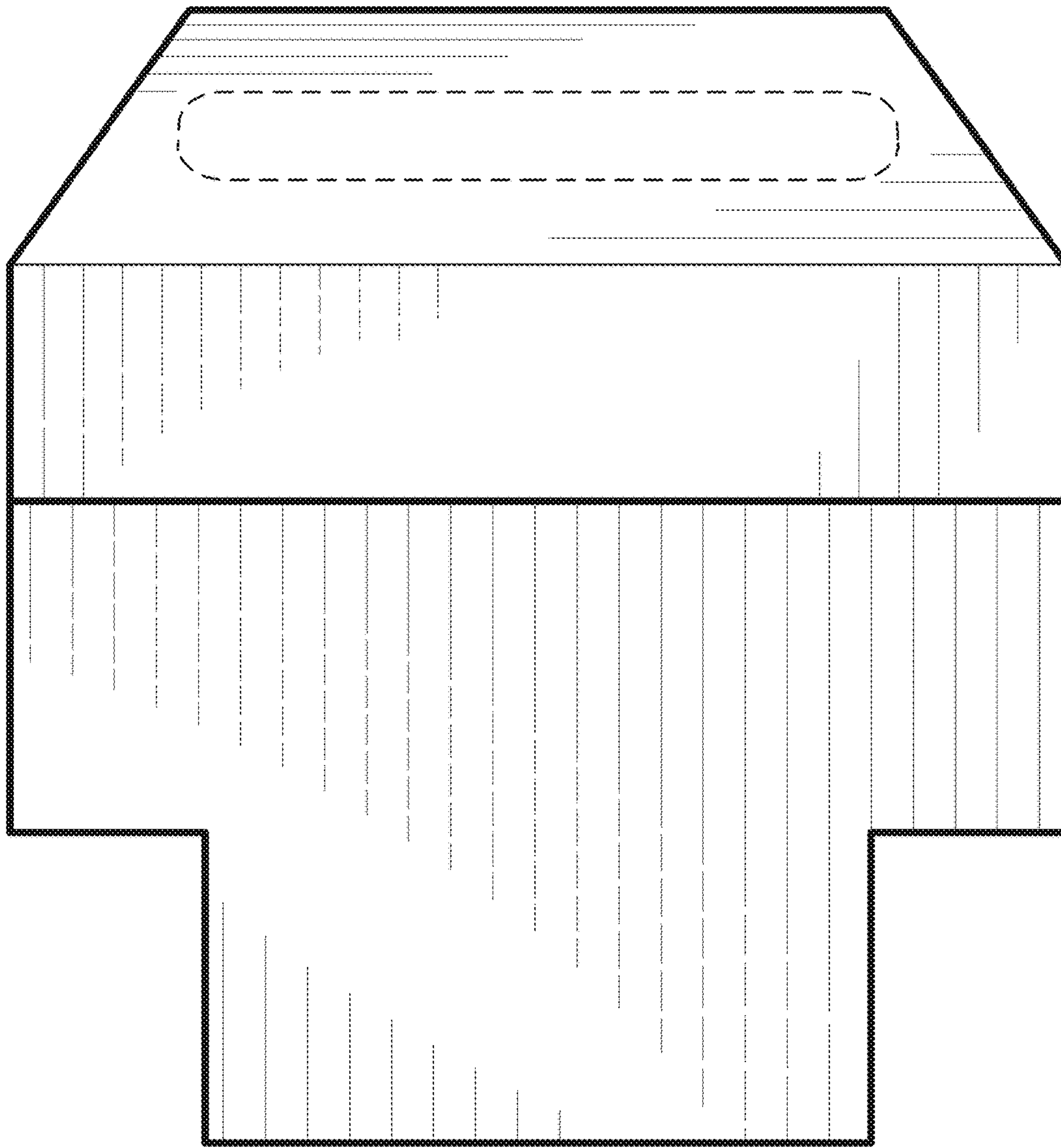

FIG. 10

© 2017 Kimbo Campers LLC



© 2017 Kimbo Campers LLC

FIG. 11

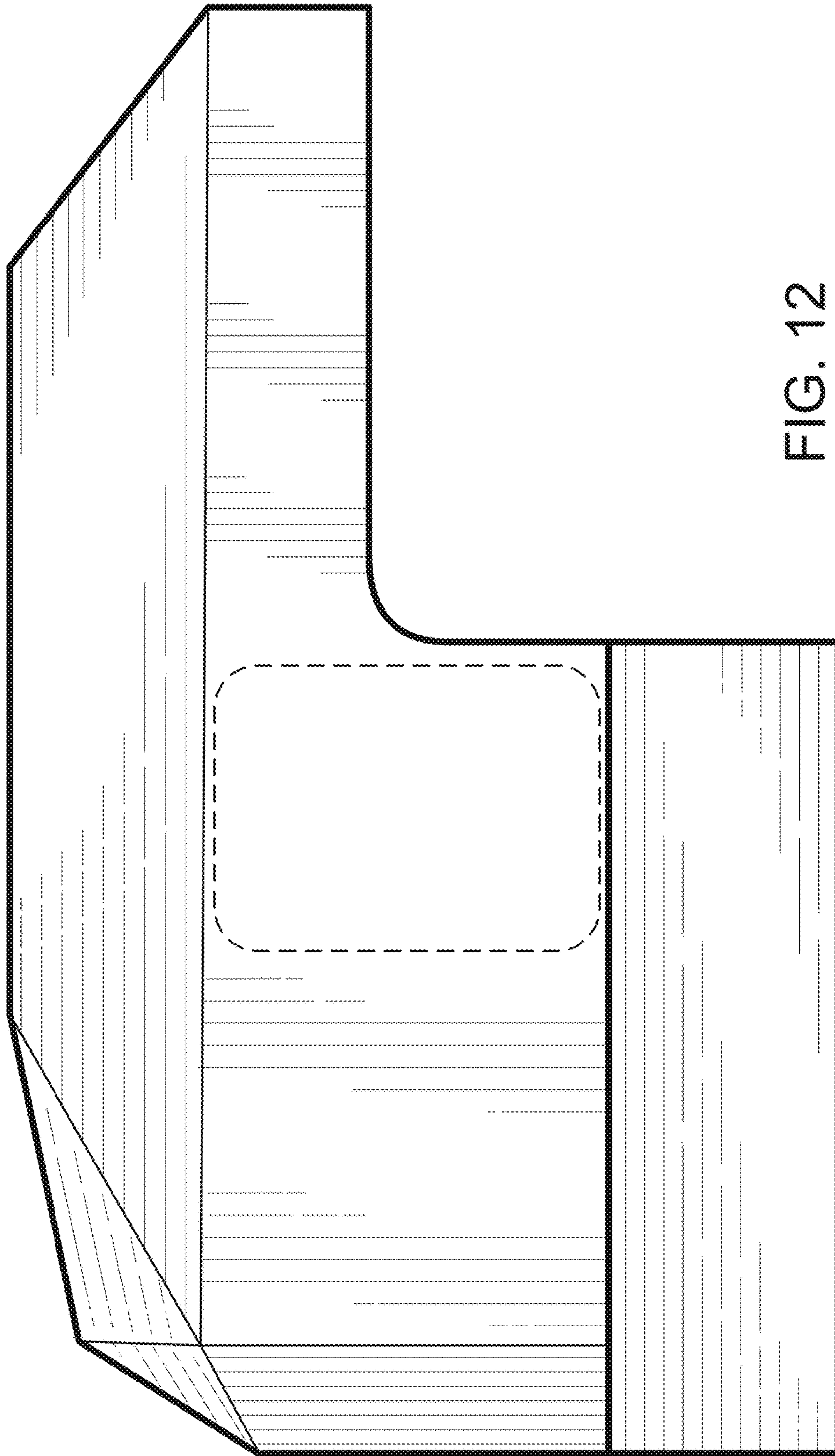

FIG. 12

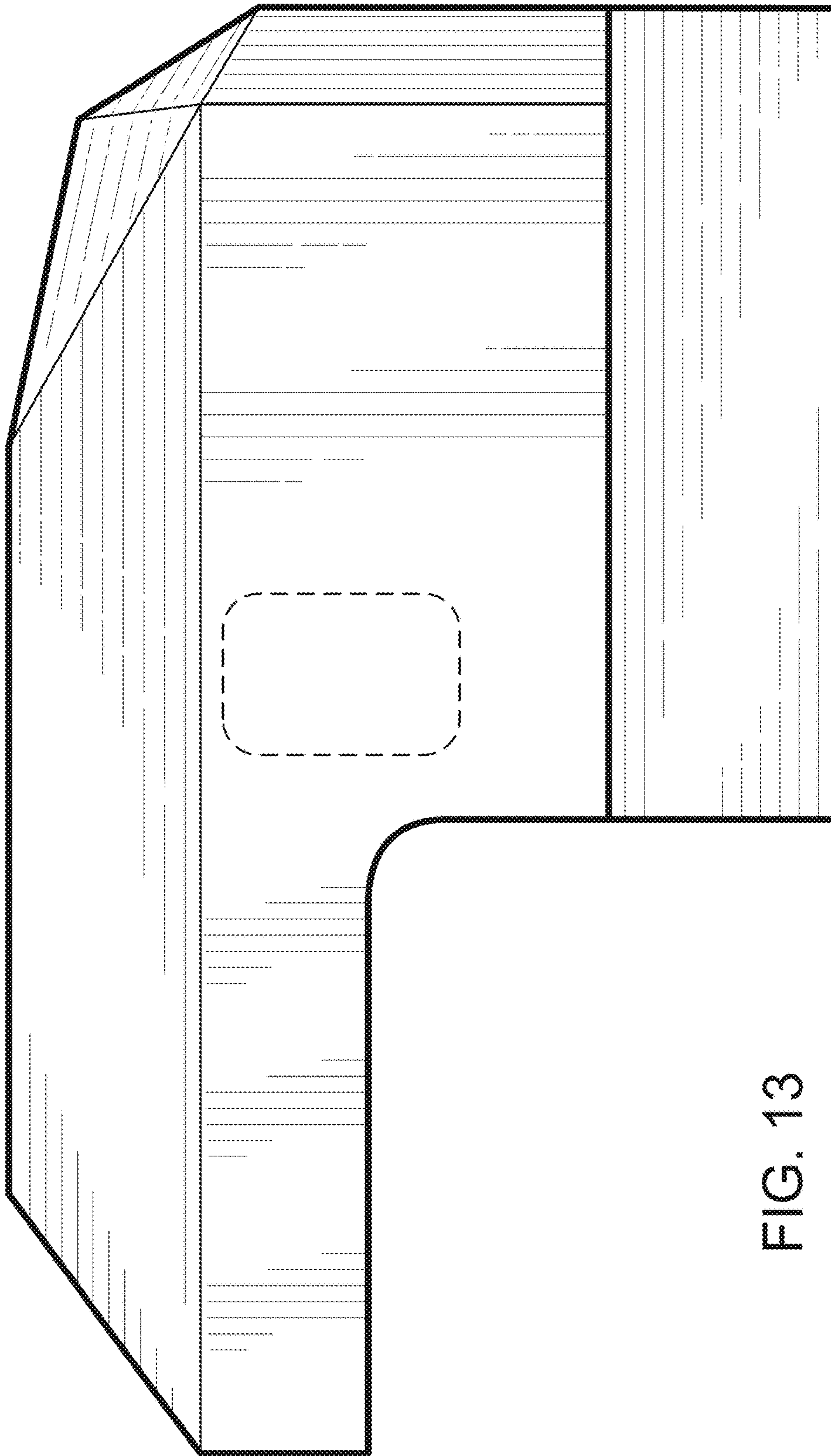
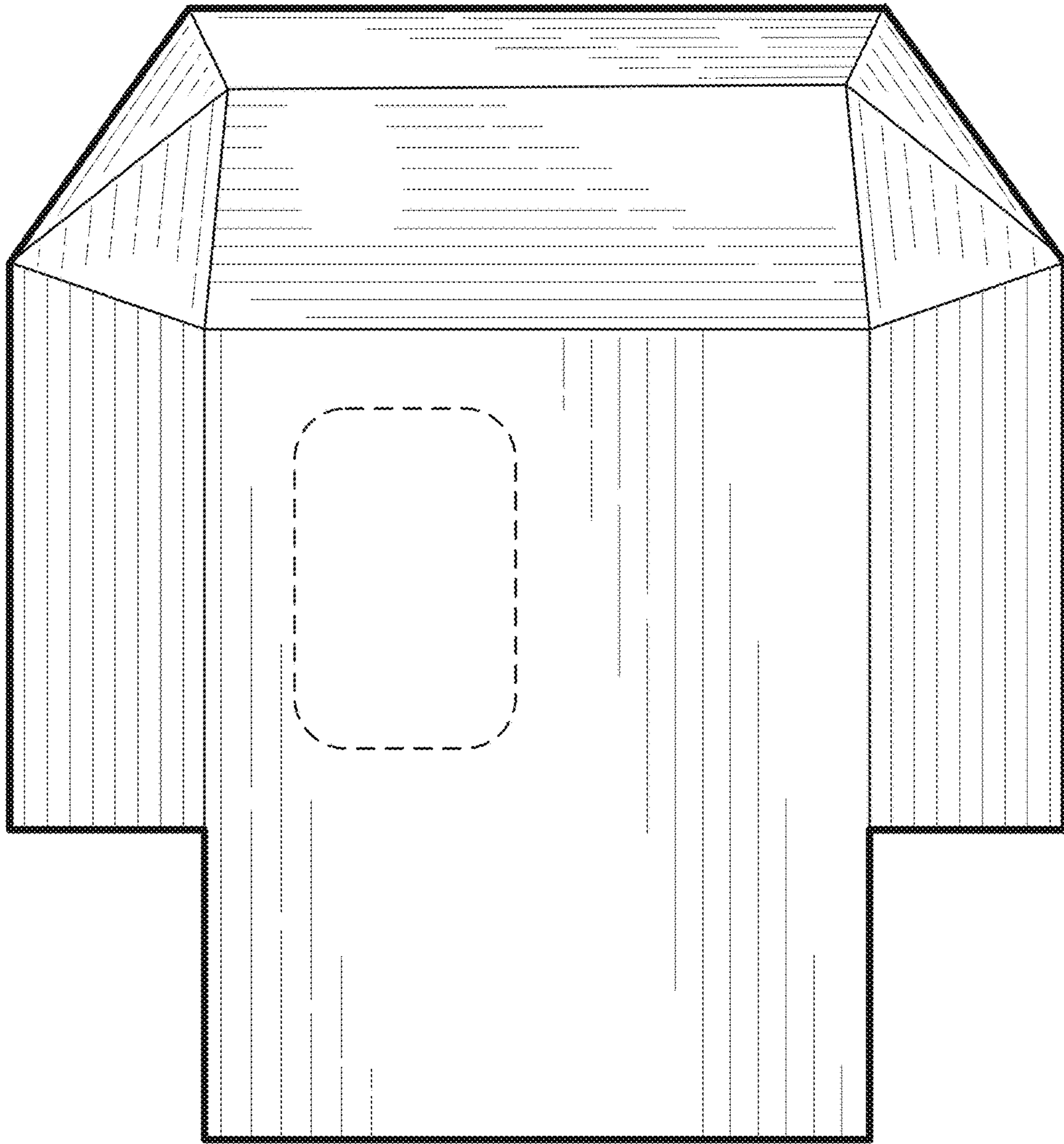

FIG. 13

© 2017 Kimbo Campers LLC



© 2017 Kimbo Campers LLC

FIG. 14

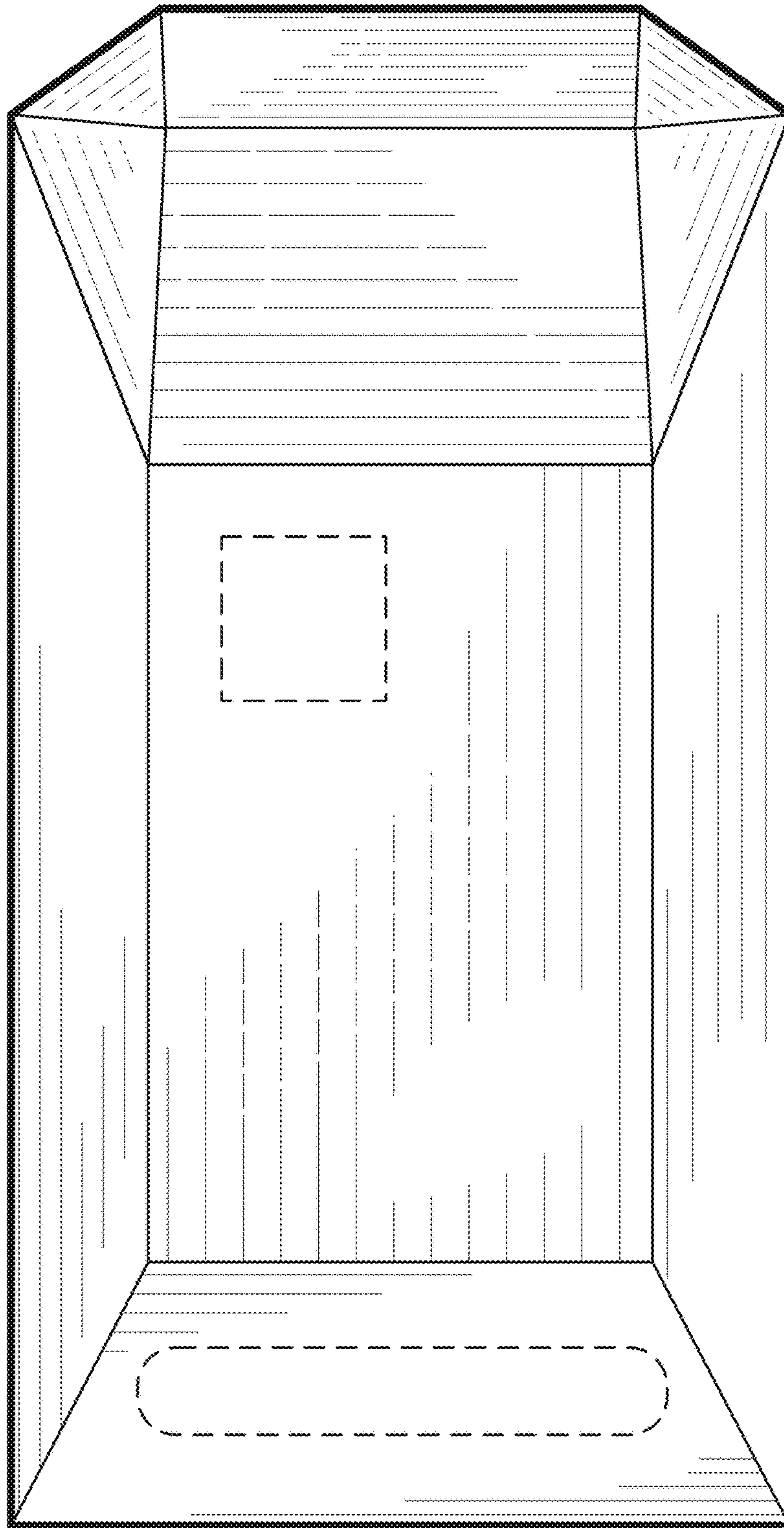

© 2017 Kimbo Campers LLC

FIG. 15

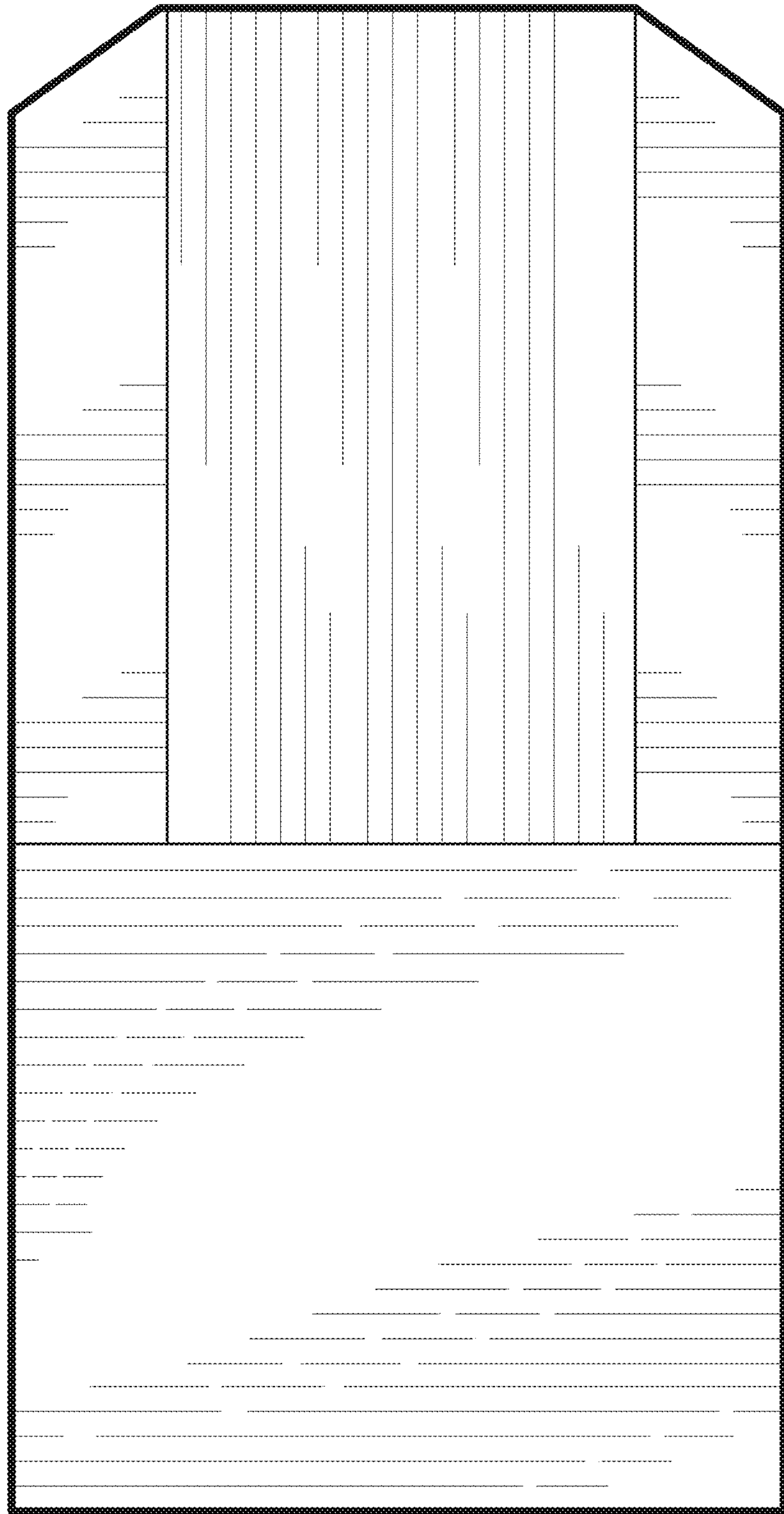

© 2017 Kimbo Campers LLC

FIG. 16

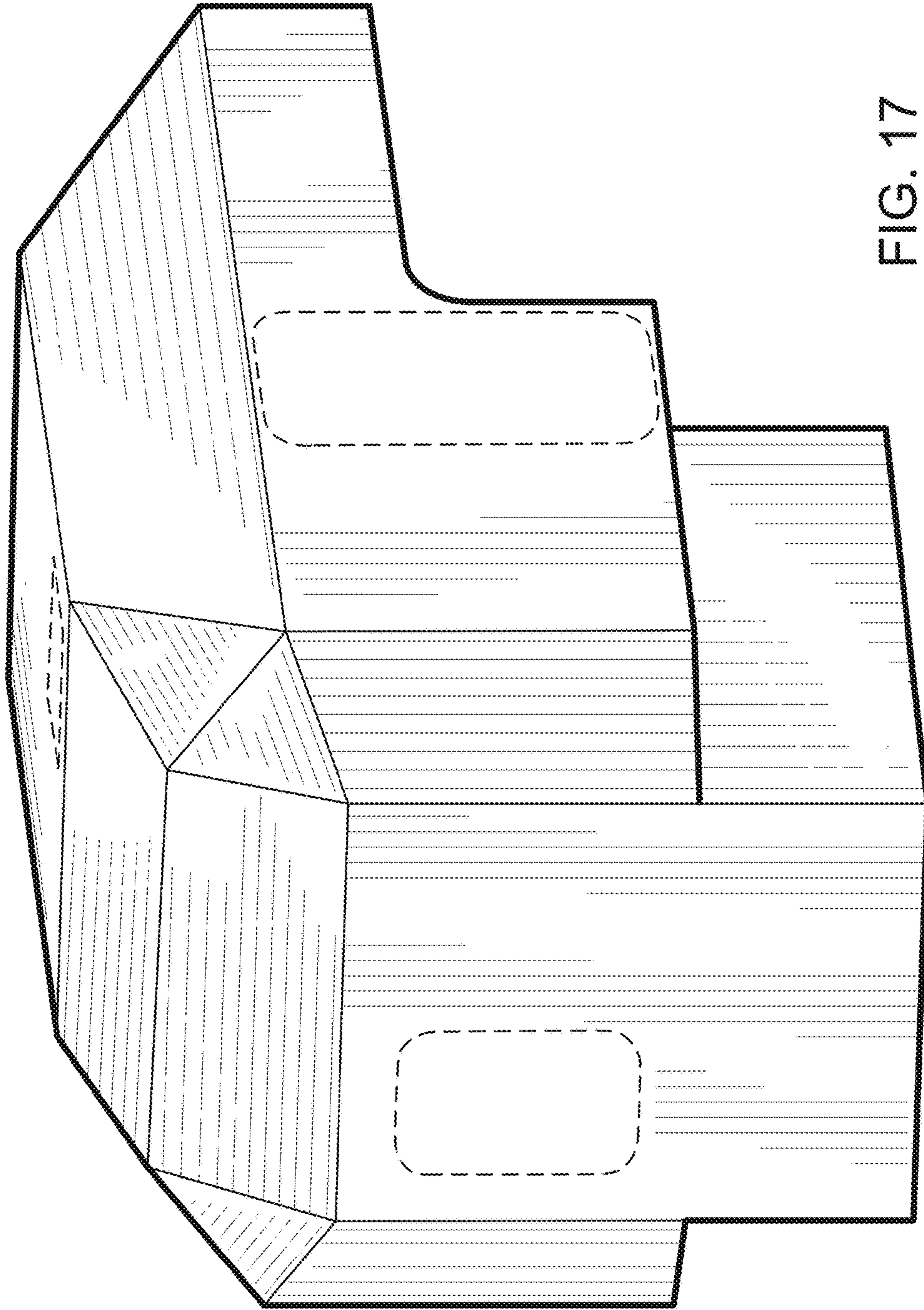

FIG. 17

© 2017 Kimbo Campers LLC

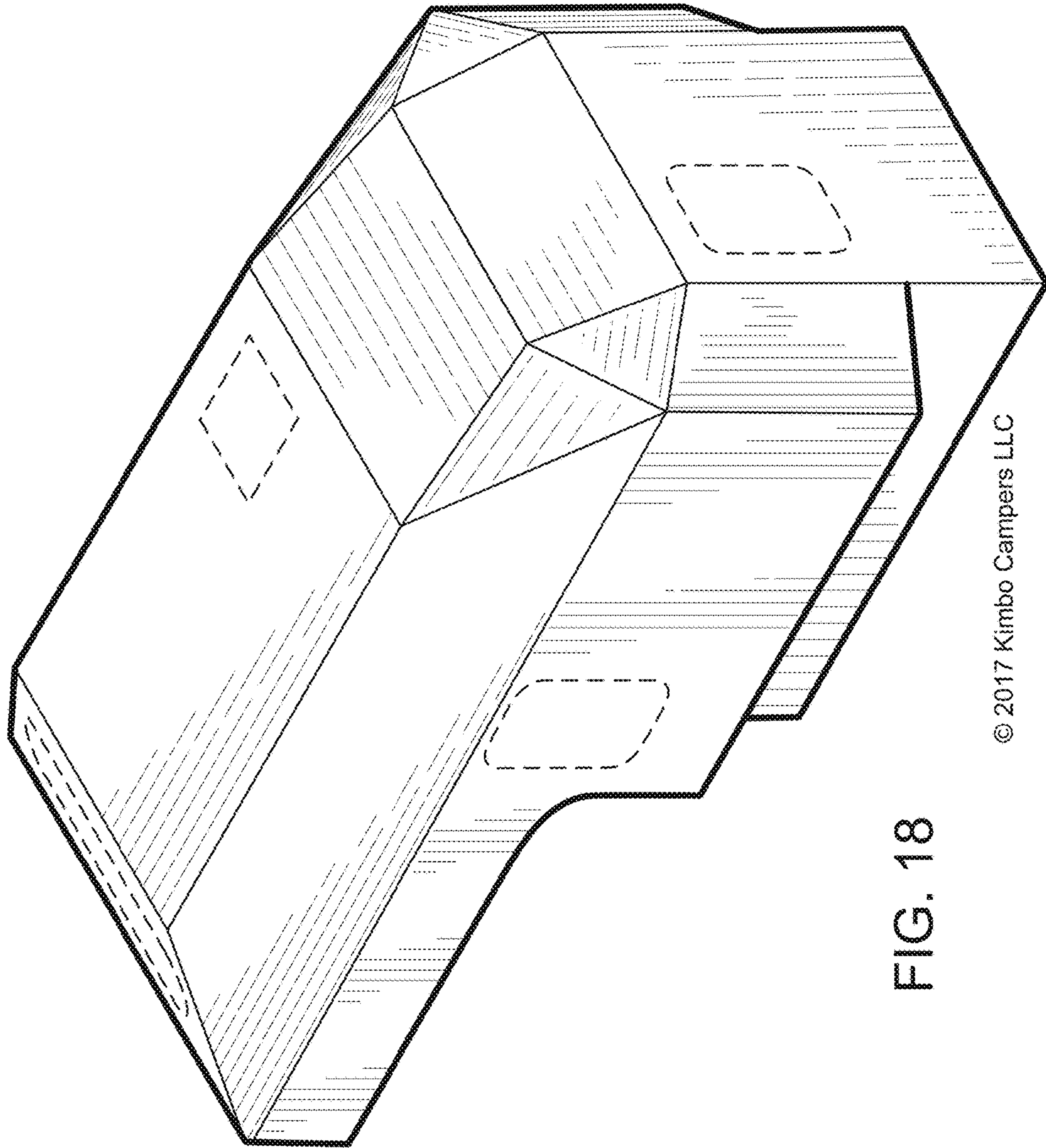

FIG. 18

© 2017 Kimbo Campers LLC