



US00D836506S

(12) **United States Design Patent** (10) **Patent No.:** **US D836,506 S**
Arbesman (45) **Date of Patent:** **** Dec. 25, 2018**

(54) **BRAKE SHIM**
(71) Applicant: **NUCAP INDUSTRIES INC.,**
Scarborough (CA)
(72) Inventor: **Ray Arbesman,** Toronto (CA)
(73) Assignee: **Nucap Industries Inc.,** Toronto,
Ontario (CA)
(**) Term: **15 Years**
(21) Appl. No.: **29/573,562**
(22) Filed: **Aug. 8, 2016**
(51) **LOC (11) Cl.** **12-16**
(52) **U.S. Cl.**
USPC **D12/180**
(58) **Field of Classification Search**
USPC D12/114, 126, 127, 180
CPC F16D 65/005; F16D 65/0081
See application file for complete search history.

D547,245 S * 7/2007 Sehmer D12/180
7,481,304 B2 1/2009 Tsurumi et al.
7,926,627 B2 4/2011 Wake et al.
D688,609 S * 8/2013 Arbesman D12/180
D688,610 S * 8/2013 Arbesman D12/180
D688,996 S 9/2013 Arbesman et al.

(Continued)

FOREIGN PATENT DOCUMENTS

CA 151974 4/2014
EP 1927779 A1 6/2008
JP 2001-041268 A 2/2001

(Continued)

OTHER PUBLICATIONS

www.nucap.com: NU-LOK Shims. (C) 2018; 4 pages. Found online
Jul. 26, 2018 at <http://nucap.com/nulok-shims/> (Year: 2018).*

(Continued)

Primary Examiner — Robert M. Spear
(74) *Attorney, Agent, or Firm* — Aird & McBurney LLP

(56) **References Cited**
U.S. PATENT DOCUMENTS

D337,293 S * 7/1993 Steinke D12/180
D338,648 S * 8/1993 Steinke D12/180
D341,350 S * 11/1993 Steinke D12/180
D341,807 S * 11/1993 Steinke D12/180
D354,265 S 1/1995 Steinke et al.
D356,533 S * 3/1995 Steinke D12/180
D357,448 S * 4/1995 Steinke D12/180
D357,450 S 4/1995 Steinke et al.
D357,658 S * 4/1995 Steinke D12/180
D359,020 S * 6/1995 Steinke D12/180
D368,453 S * 4/1996 Steinke D12/180
D368,456 S * 4/1996 Steinke D12/180
D368,458 S 4/1996 Steinke et al.
D368,459 S * 4/1996 Steinke D12/180
D368,460 S 4/1996 Steinke et al.
D368,461 S * 4/1996 Steinke D12/180
D368,691 S * 4/1996 Steinke D12/180
6,612,415 B2 9/2003 Yamane

(57) **CLAIM**

I claim the ornamental design for a brake shim, as shown and described.

DESCRIPTION

FIG. 1 is a perspective view from the front of a brake shim in accordance with said Design;
FIG. 2 is a perspective view from the rear of the brake shim of FIG. 1;
FIG. 3 is a left side view of the brake shim of FIG. 1;
FIG. 4 is a front view of the brake shim of FIG. 1;
FIG. 5 is a right side view of the brake shim of FIG. 1,
FIG. 6 is a rear view of the brake shim of FIG. 1,
FIG. 7 is a top view of the brake shim of FIG. 1; and,
FIG. 8 is a bottom view of the brake shim of FIG. 1.

1 Claim, 3 Drawing Sheets

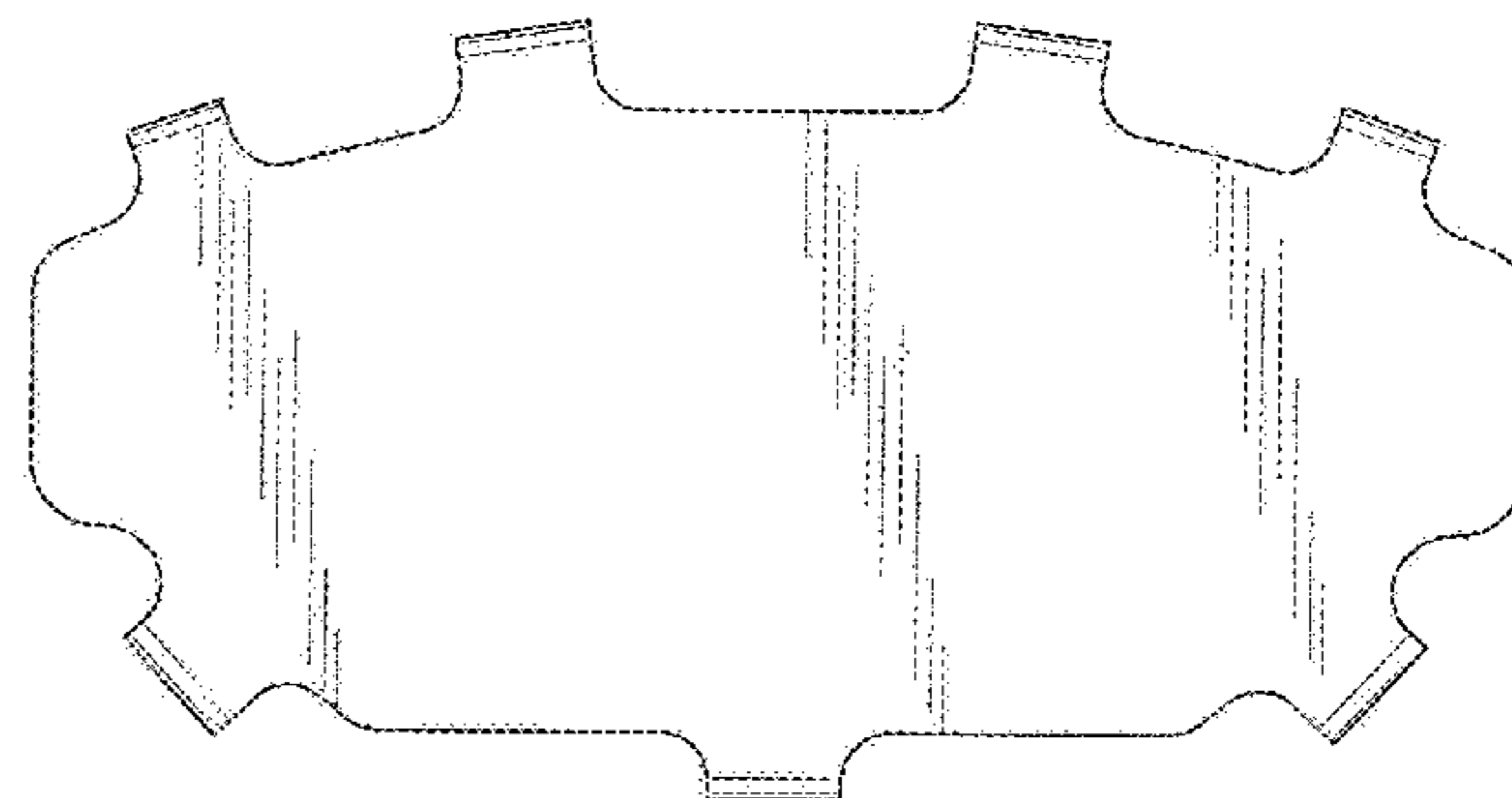
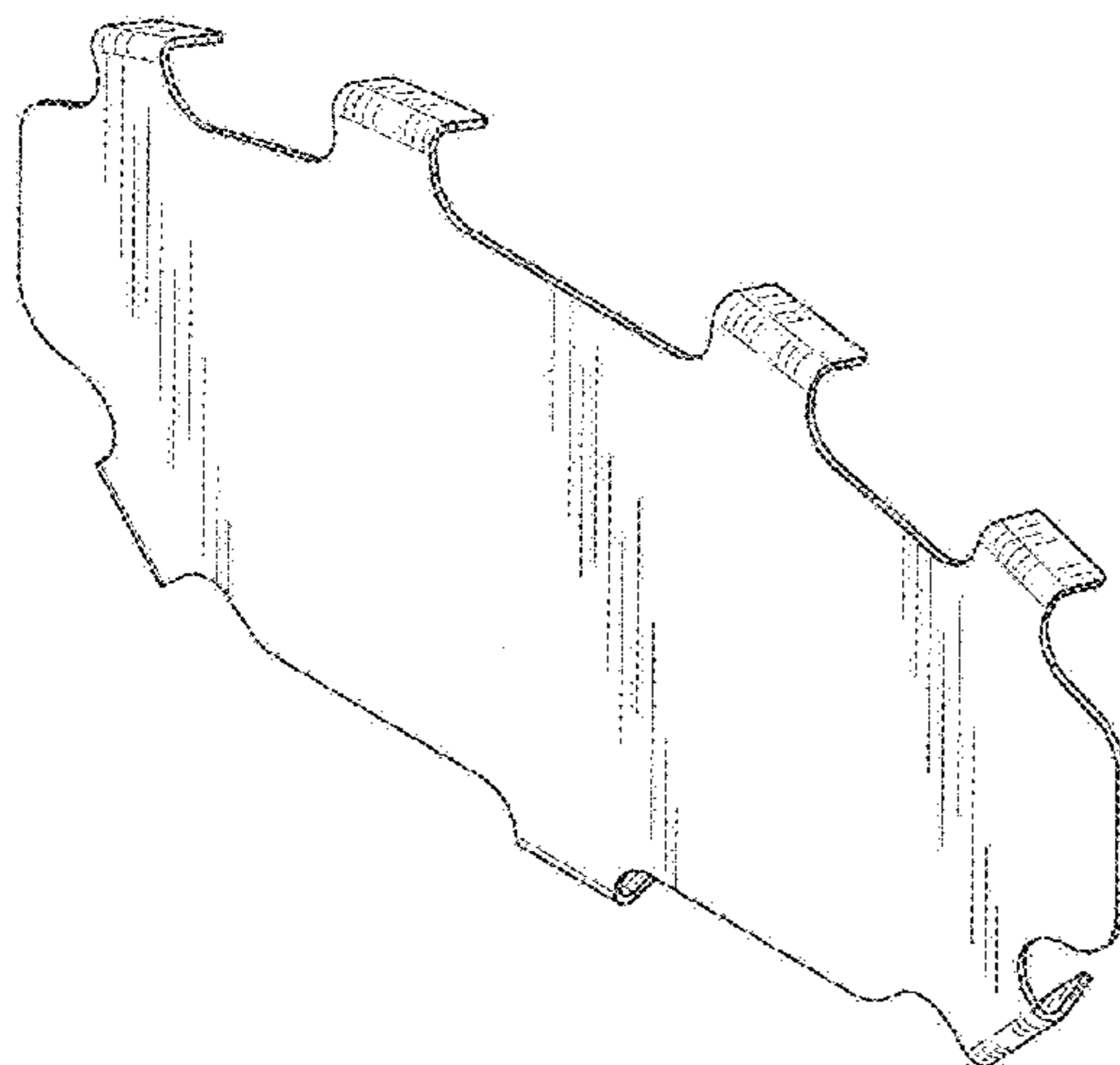

(56)

References Cited

U.S. PATENT DOCUMENTS

D688,997 S 9/2013 Arbesman et al.
2013/0068574 A1 3/2013 Arbesman

FOREIGN PATENT DOCUMENTS

JP 2010-031960 A 2/2010
JP 2012-215279 A 11/2012

OTHER PUBLICATIONS

Nucap Industries Inc., Colored Shims, <URL: <http://nucap.com/products/shims/colored>>, accessed on Sep. 20, 2016.
Nucap Industries Inc., Logoed Shims, <URL: <http://nucap.com/products/shims/logoed>>, accessed on Sep. 20, 2016.
Nucap Industries Inc., Conventional Shims, <URL: <http://nucap.com/products/shims/conventional>>, accessed on Sep. 20, 2016.

Nucap Industries Inc., NU-LOK—Independent Floating Shim Technology, <URL: <http://nucap.com/products/shims/nu-ok>>, accessed on Sep. 20, 2016.

EuroLine Disc Brake Pads. www.boschautoparts.com. Apr. 12, 2013 [online], [retrieved on May 2, 2013]. Retrieved from the Internet <URL: <http://www.boschautoparts.com/Brakes/Pages/EuroLineDiscBrakePads.aspx>>.

Genuine Brake Pad Shim Set—2001 Lexus GS. www.carid.com. Apr. 13, 2013 [online], [retrieved on May 2, 2013]. Retrieved from the Internet <URL: <http://www.carid.com/2001-lexus-gs-brake-parts/item-8791215.html>>.

6 shims on OEM brake pads. www.civicforums.com. Mar. 29, 2010 [online], [retrieved on May 2, 2013]. Retrieved from the Internet <URL: <http://www.civicforums.com/forums/43-wheels-tires-brakes/327491-6-shims-oem-brake-pads.html>>.

NUCAP Introduces NU-LOK Line of Brake Pad Shims. www.underhoodservice.com. Feb. 7, 2007 [online], [retrieved on May 2, 2013]. Retrieved from the Internet <URL: <http://www.underhoodservice.com/issue/article.aspx?contentid=44263>>.

* cited by examiner

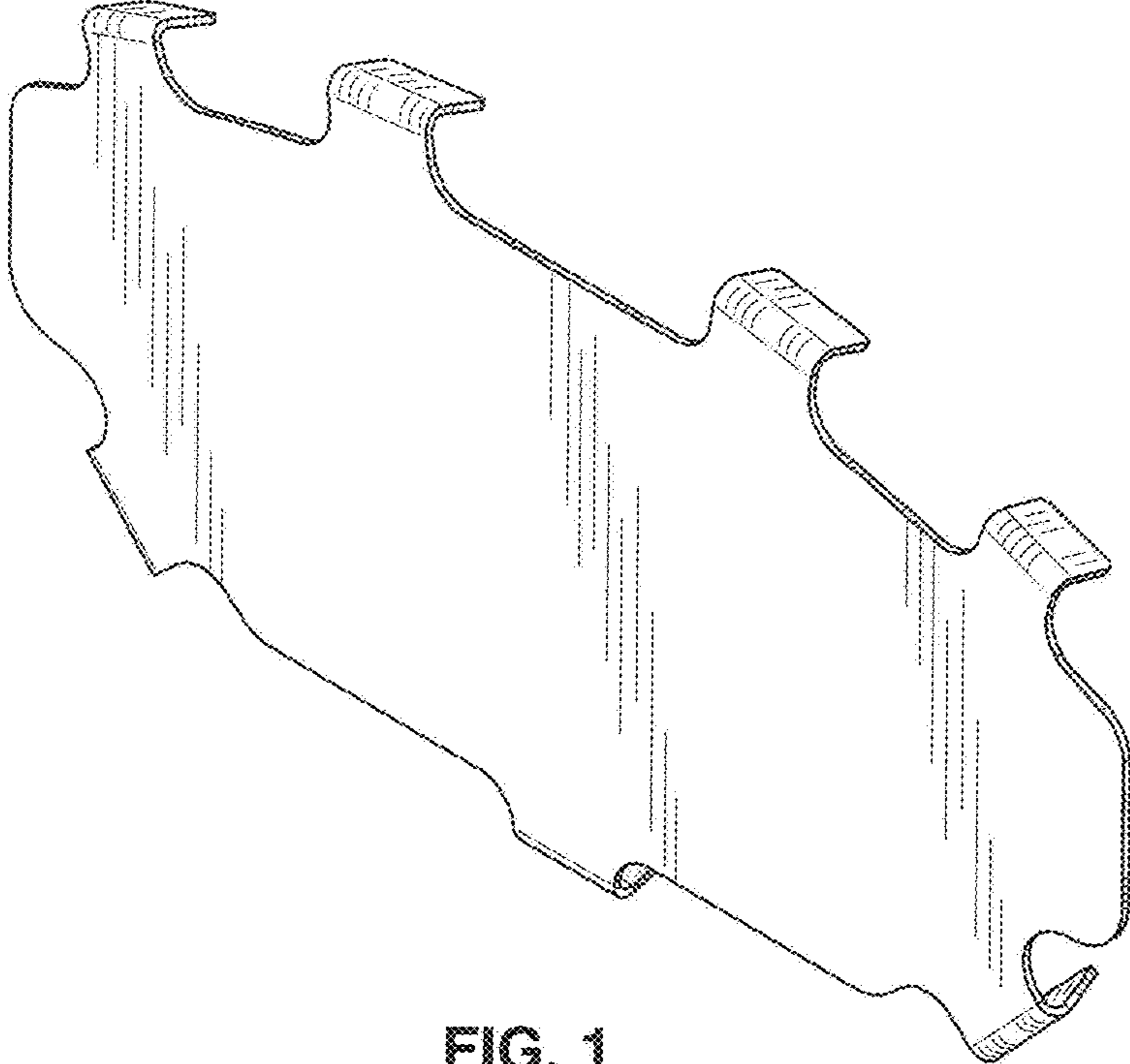

FIG. 1

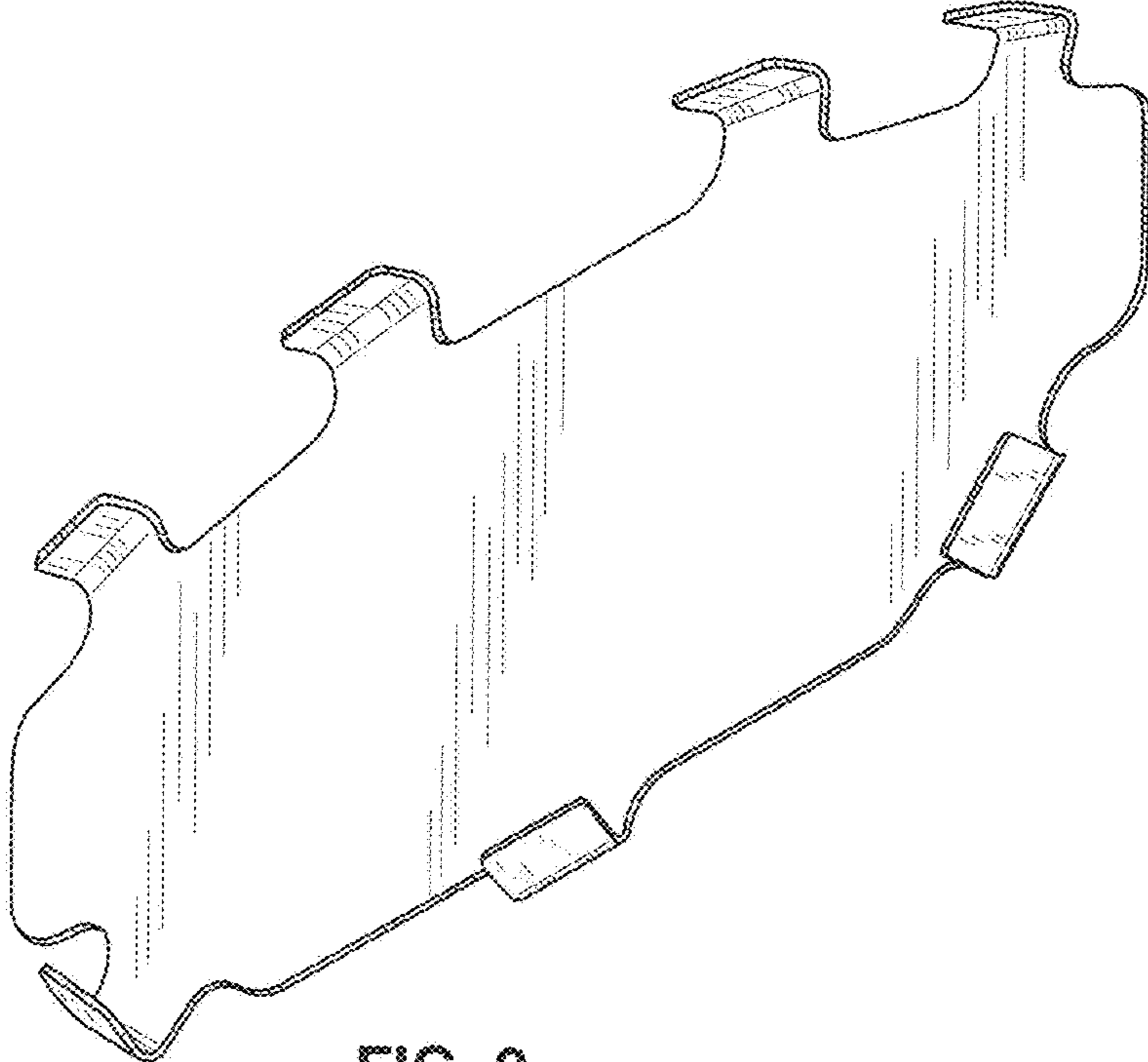

FIG. 2



FIG. 3

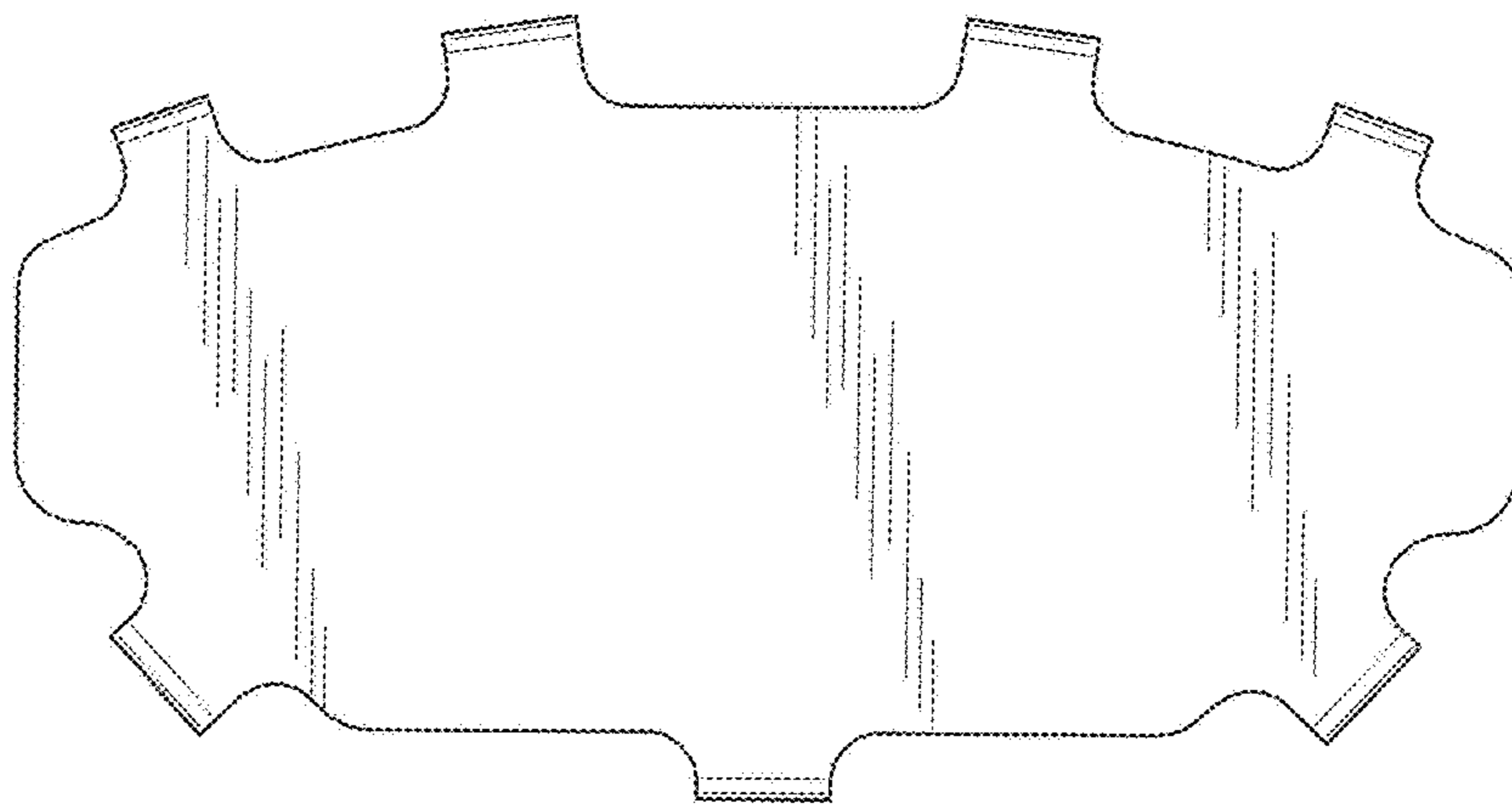

FIG. 4

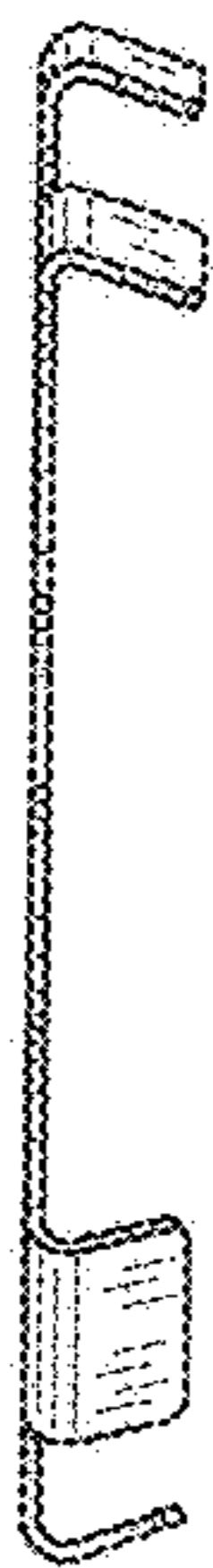

FIG. 5

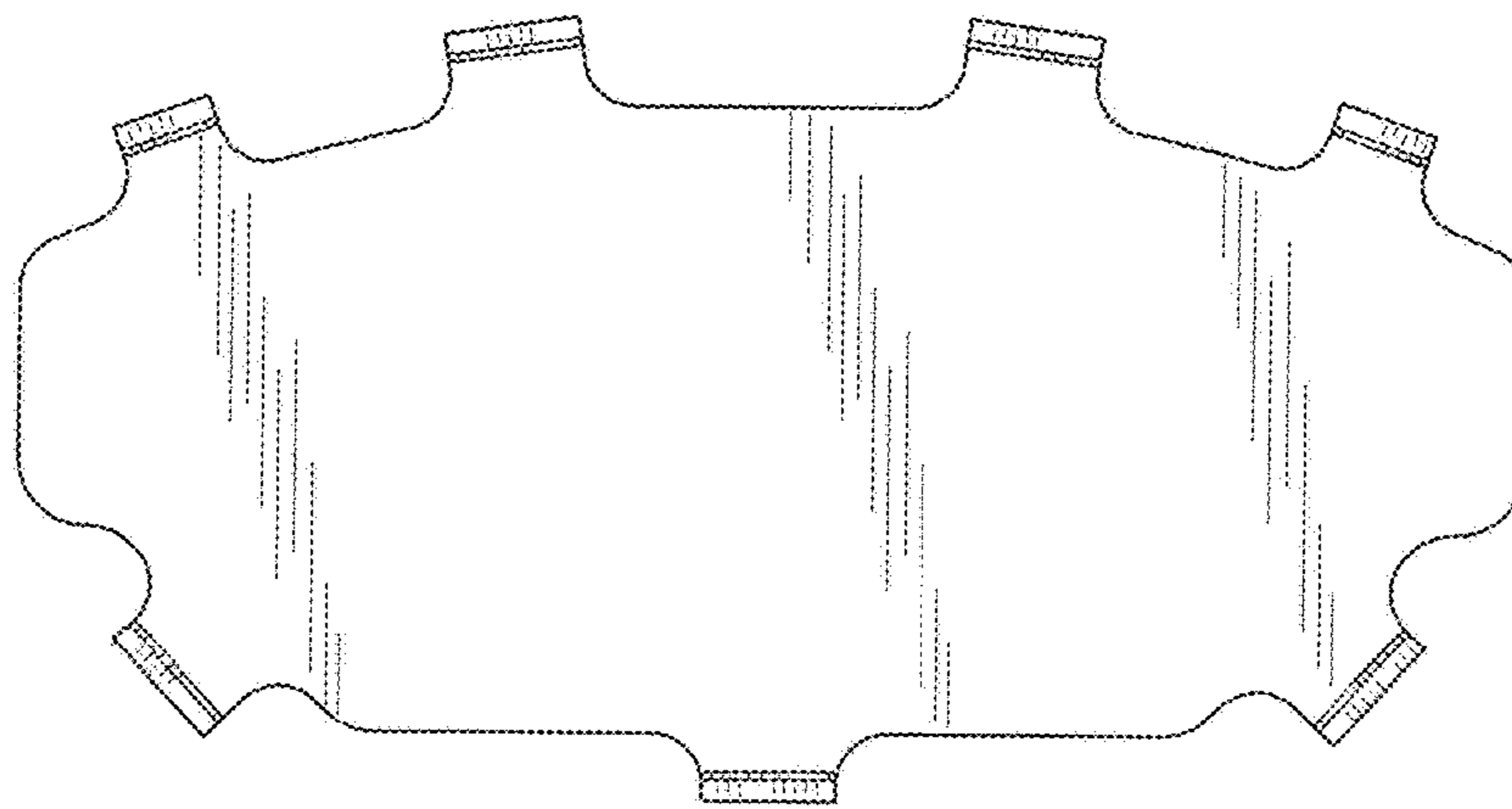

FIG. 6



FIG. 7

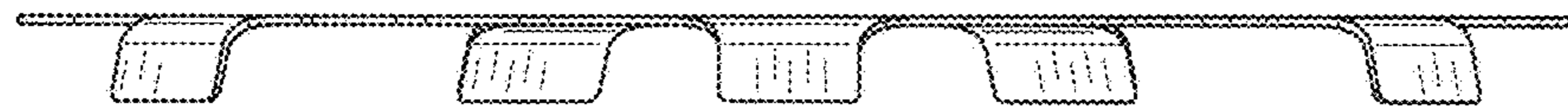

FIG. 8