



US00D836417S

(12) **United States Design Patent**
Gokcebay

(10) **Patent No.:** **US D836,417 S**

(45) **Date of Patent:** **** Dec. 25, 2018**

- (54) **ELECTRONIC LOCKER LOCK**
- (71) Applicant: **Digilock Asia Ltd.**, Kowloon (HK)
- (72) Inventor: **Asil T. Gokcebay**, Petaluma, CA (US)
- (73) Assignee: **Digilock Asia Ltd.**, Kowloon (HK)
- (**) Term: **15 Years**
- (21) Appl. No.: **29/590,751**
- (22) Filed: **Jan. 12, 2017**
- (51) **LOC (11) Cl.** **08-07**
- (52) **U.S. Cl.**
USPC **D8/331; D8/330**
- (58) **Field of Classification Search**
USPC D8/301, 302, 330, 331, 349, 400, 499;
70/57, 57.1, 14, 20, 91, 92, 102, 141,
70/237, 262, 263, 266, 278.1, 279.1, 416,
70/465, 442, 443, 214, 78, 447; 340/5.6,
340/5.61, 5.64, 5.73, 286.01, 542, 547,
340/545.1, 545.7; 292/336.3, 257, 194,
292/195, 198, 164, 165
CPC E05B 49/00; E05B 41/00; E05B 65/52;
E05B 51/00; E06B 65/00; B65D 55/07
See application file for complete search history.

- 6,016,955 A * 1/2000 De Rooij G06Q 20/04
235/379
- D426,833 S * 6/2000 Vanelli D14/387
- D495,578 S * 9/2004 Sampson D8/330
- D512,898 S * 12/2005 Metivier D10/106.1
- 7,336,150 B2 * 2/2008 Gokcebay E05B 47/06
340/5.2
- D730,712 S 6/2015 Gokcebay et al.
- D730,714 S 6/2015 Gokcebay et al.
- D730,715 S 6/2015 Gokcebay et al.
- D731,286 S 6/2015 Gokcebay et al.
- D731,287 S 6/2015 Gokcebay et al.
- D733,519 S 7/2015 Gokcebay et al.
- D734,125 S 7/2015 Kodama

(Continued)

Primary Examiner — Elizabeth J Oswecki
(74) *Attorney, Agent, or Firm* — Thomas M. Freiburger

(57) **CLAIM**

The ornamental design for an electronic locker lock, as shown and described.

DESCRIPTION

FIG. 1 is a front, left perspective view of a first embodiment of an electronic locker lock, showing our new design;
 FIG. 2 is a top plan view thereof;
 FIG. 3 is a left side elevation view thereof;
 FIG. 4 is a front elevation view thereof;
 FIG. 5 is a right side elevation view thereof;
 FIG. 6 is a bottom plan view thereof;
 FIG. 7 is a front, left perspective view of a second embodiment of an electronic locker lock, showing our new design;
 FIG. 8 is a top plan view thereof;
 FIG. 9 is a left side elevation view thereof;
 FIG. 10 is a front elevation view thereof;
 FIG. 11 is a right side elevation view thereof; and,
 FIG. 12 is a bottom plan view thereof.
 Features shown in dashed lines are not part of the claimed design.

1 Claim, 2 Drawing Sheets

(56) **References Cited**

U.S. PATENT DOCUMENTS

- 4,148,092 A * 4/1979 Martin G07C 9/0069
361/172
- 4,926,664 A * 5/1990 Gartner E05B 47/0012
70/119
- 5,033,282 A * 7/1991 Gartner E05B 47/0012
70/119
- D327,856 S * 7/1992 Loew D10/106.95
- D331,888 S * 12/1992 Lade D10/106.1
- 5,894,277 A * 4/1999 Keskin E05B 47/00
235/382

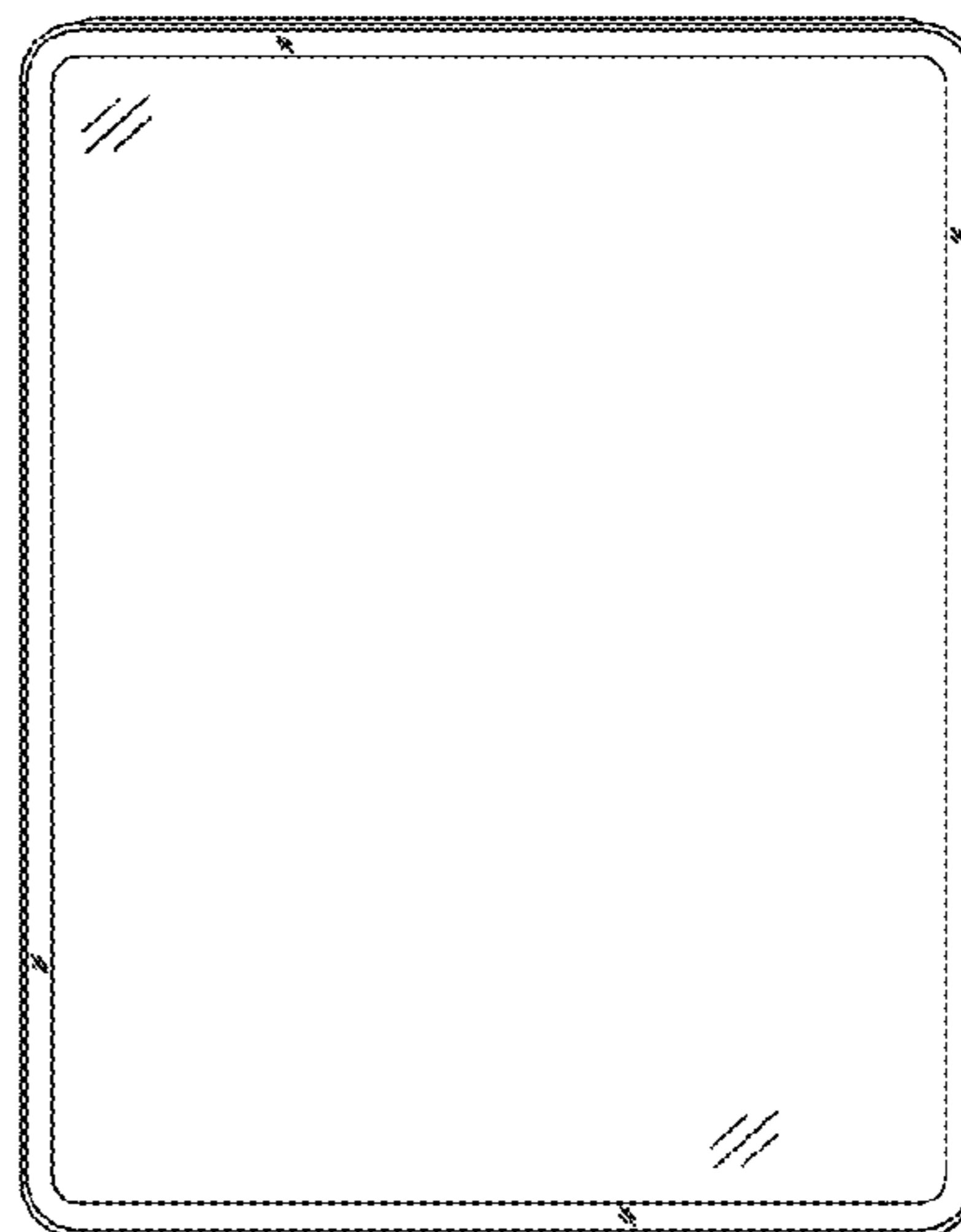
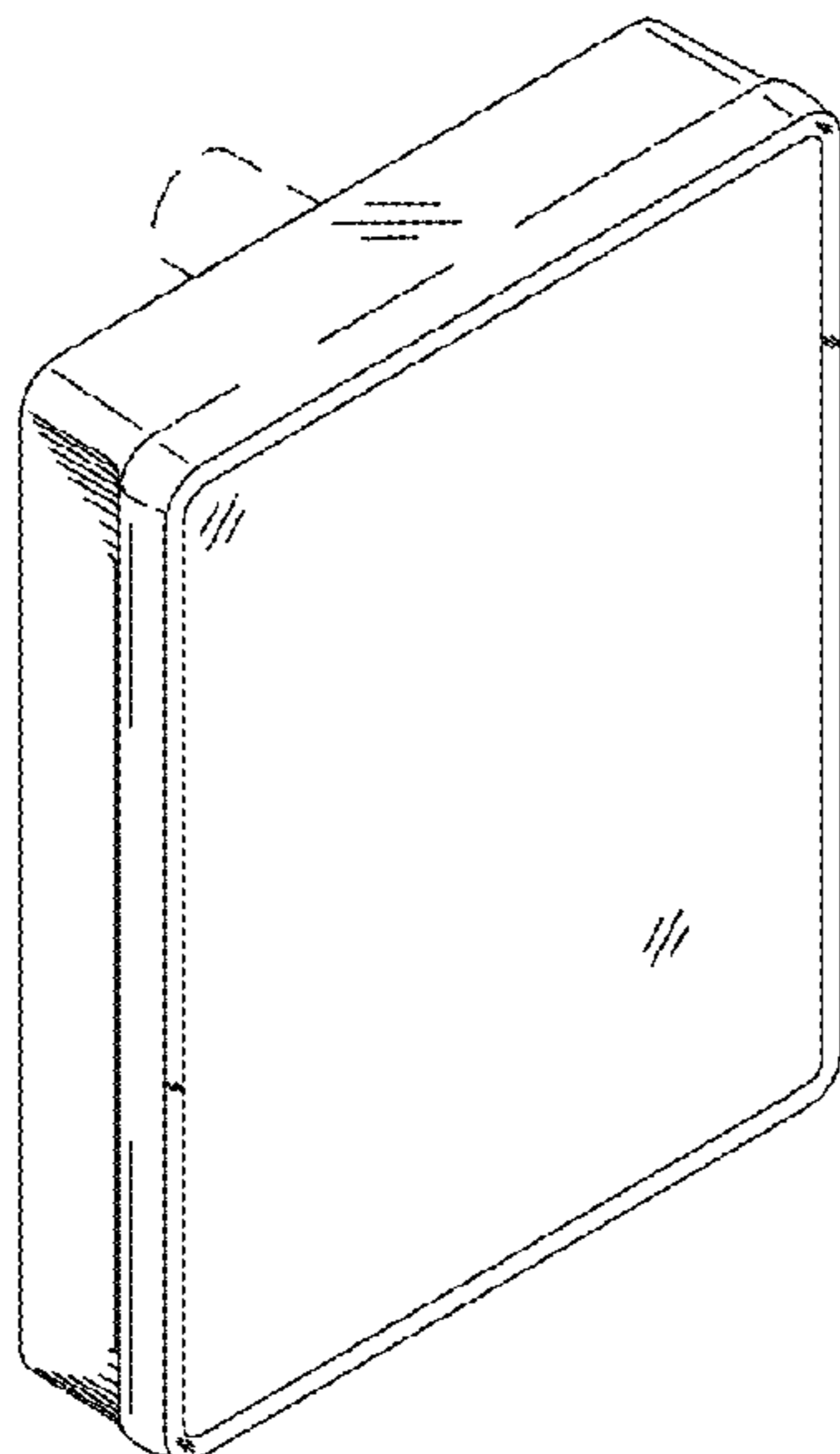

(56)

References Cited

U.S. PATENT DOCUMENTS

D734,650 S	*	7/2015	Kodama	D8/330
D737,114 S		8/2015	Gokcebay et al.	
D744,314 S	*	12/2015	Ng	D8/330
D752,945 S		4/2016	Gokcebay et al.	
D752,947 S		4/2016	Gokcebay et al.	
D752,948 S		4/2016	Gokcebay et al.	
D752,949 S		4/2016	Gokcebay et al.	
D753,463 S		4/2016	Gokcebay et al.	
D762,100 S		7/2016	Gokcebay et al.	
D762,101 S		7/2016	Gokcebay et al.	
D762,102 S		7/2016	Gokcebay et al.	
D762,103 S		7/2016	Gokcebay et al.	
D764,255 S		8/2016	Gokcebay et al.	
D764,891 S		8/2016	Gokcebay et al.	
D764,892 S		8/2016	Gokcebay et al.	
D764,893 S		8/2016	Gokcebay et al.	

* cited by examiner

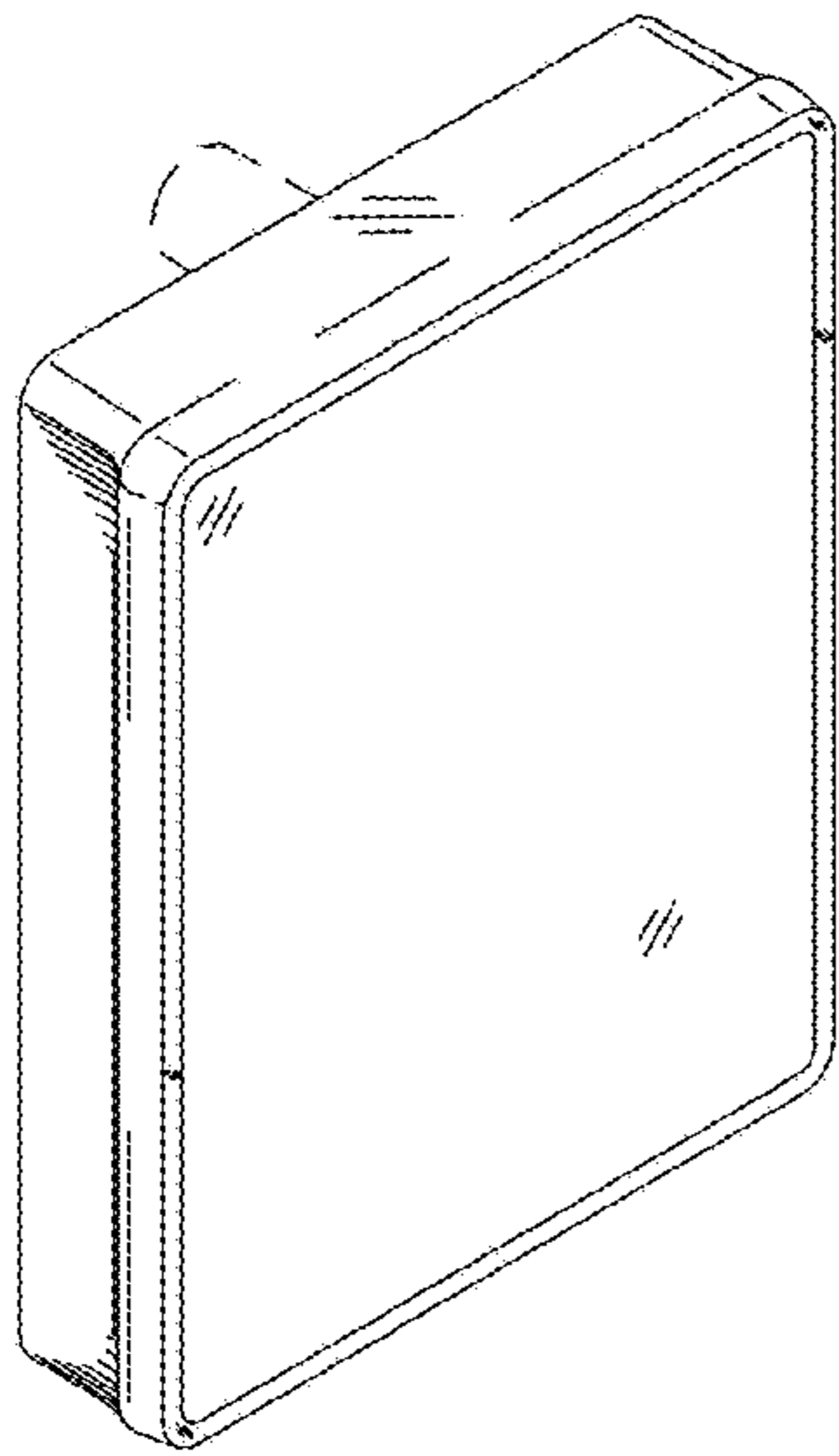

FIG. 1

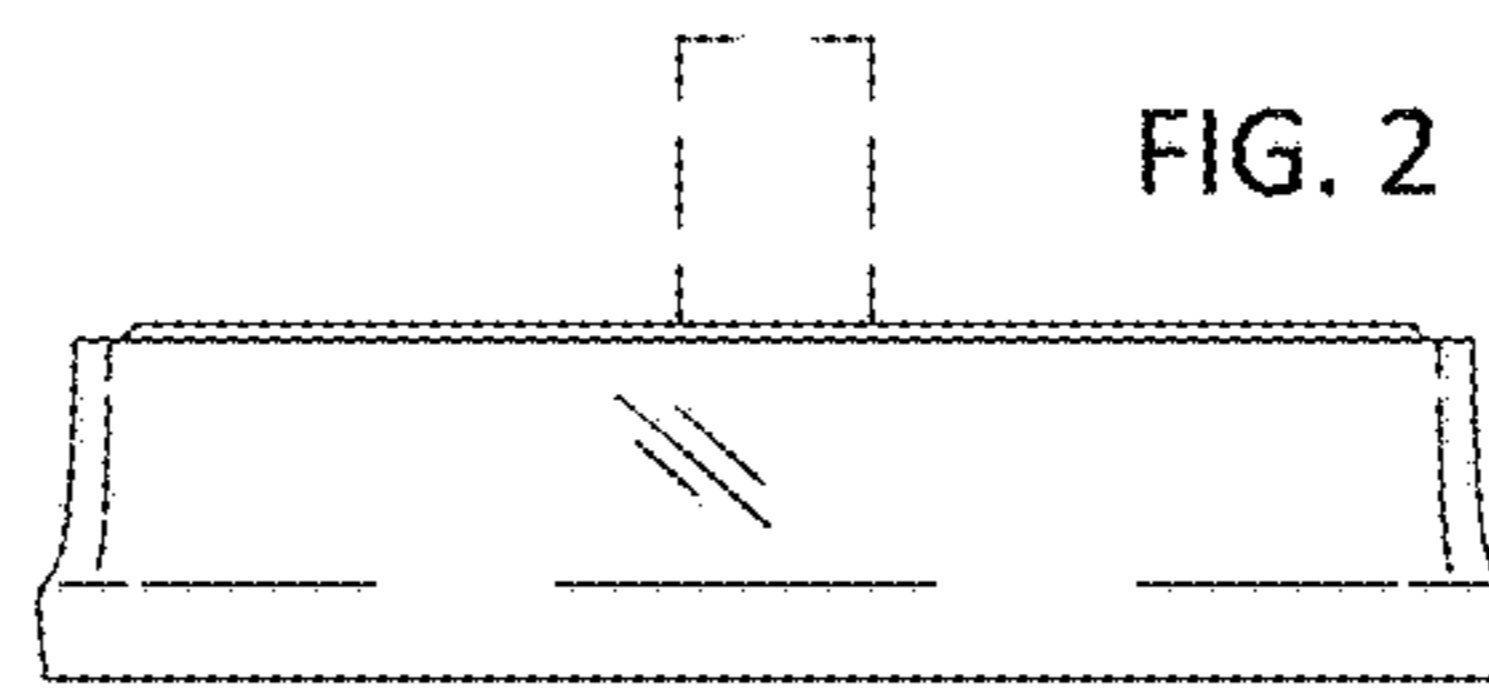

FIG. 2

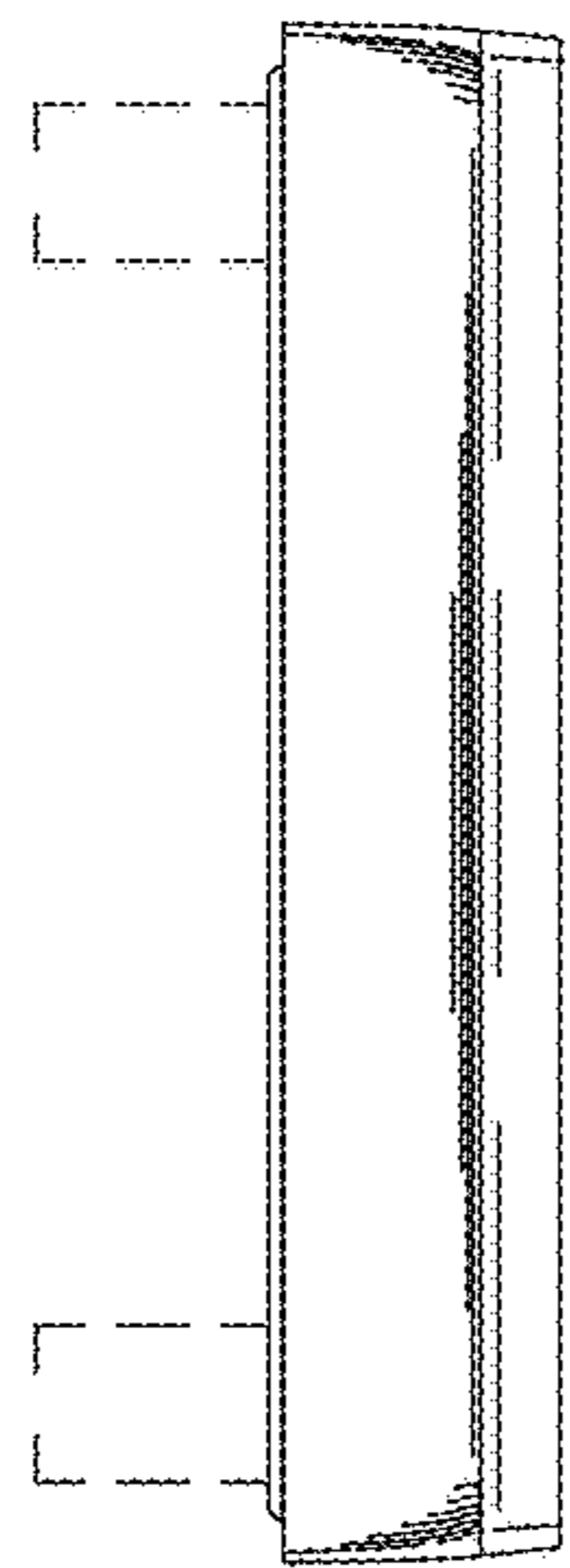

FIG. 3

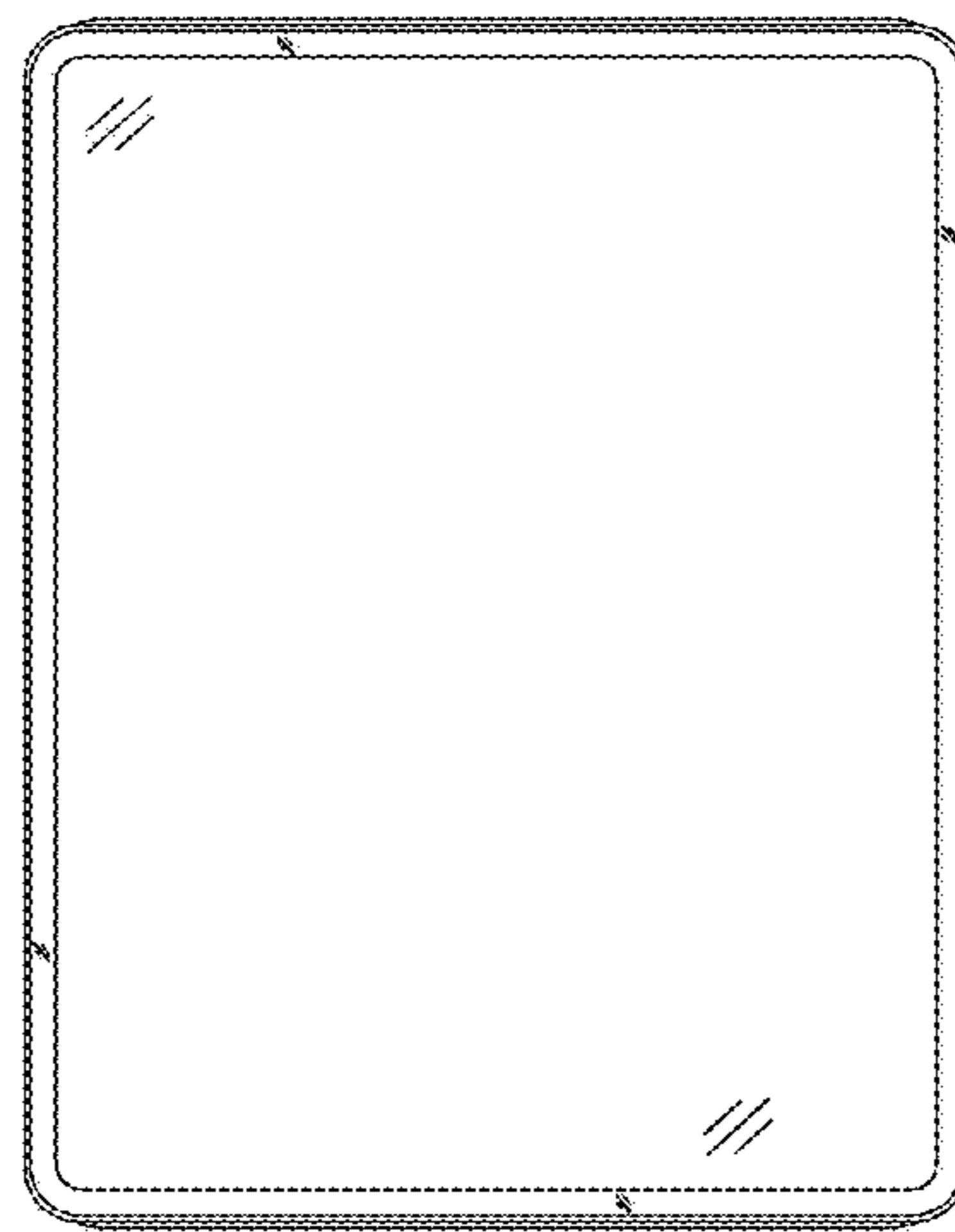

FIG. 4

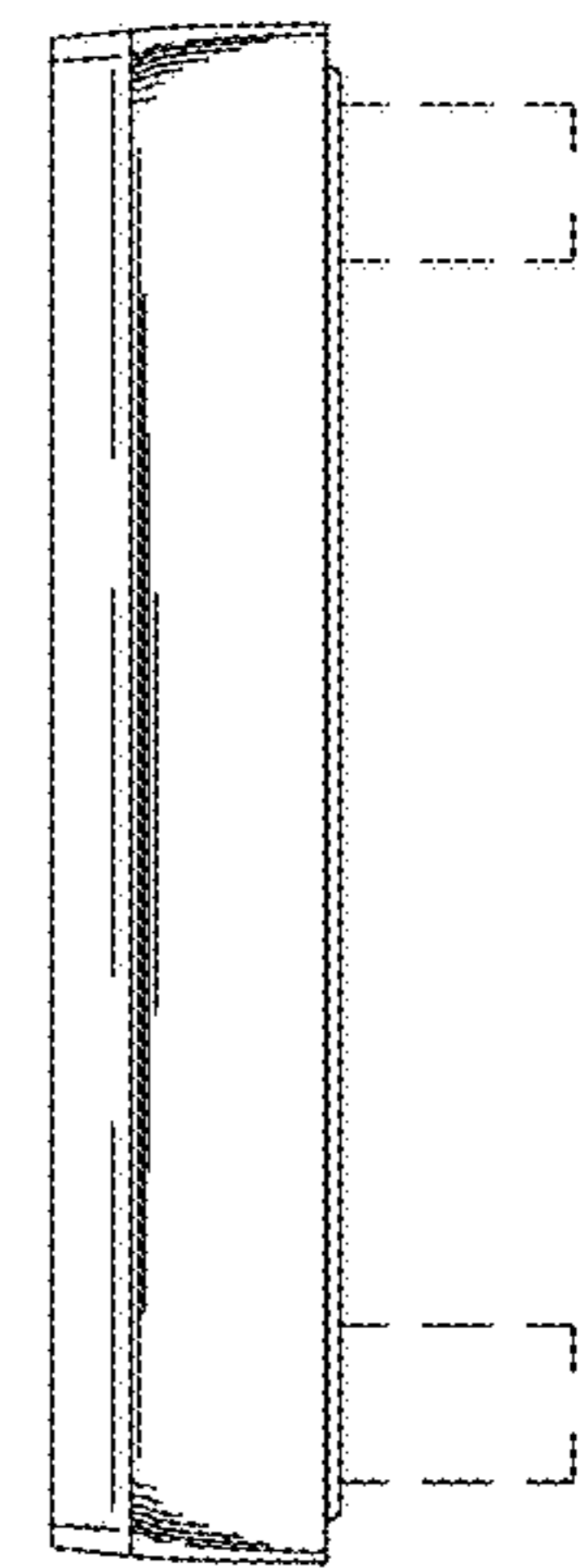

FIG. 5

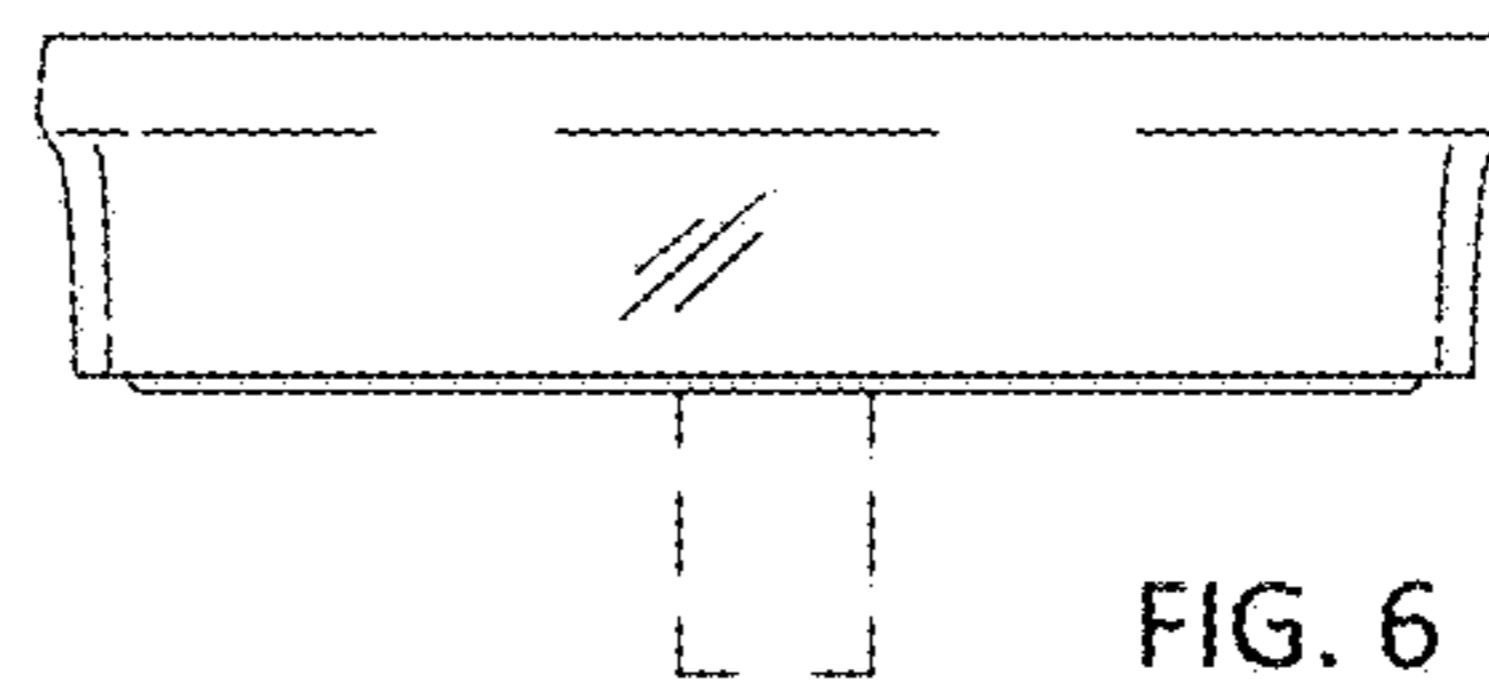

FIG. 6

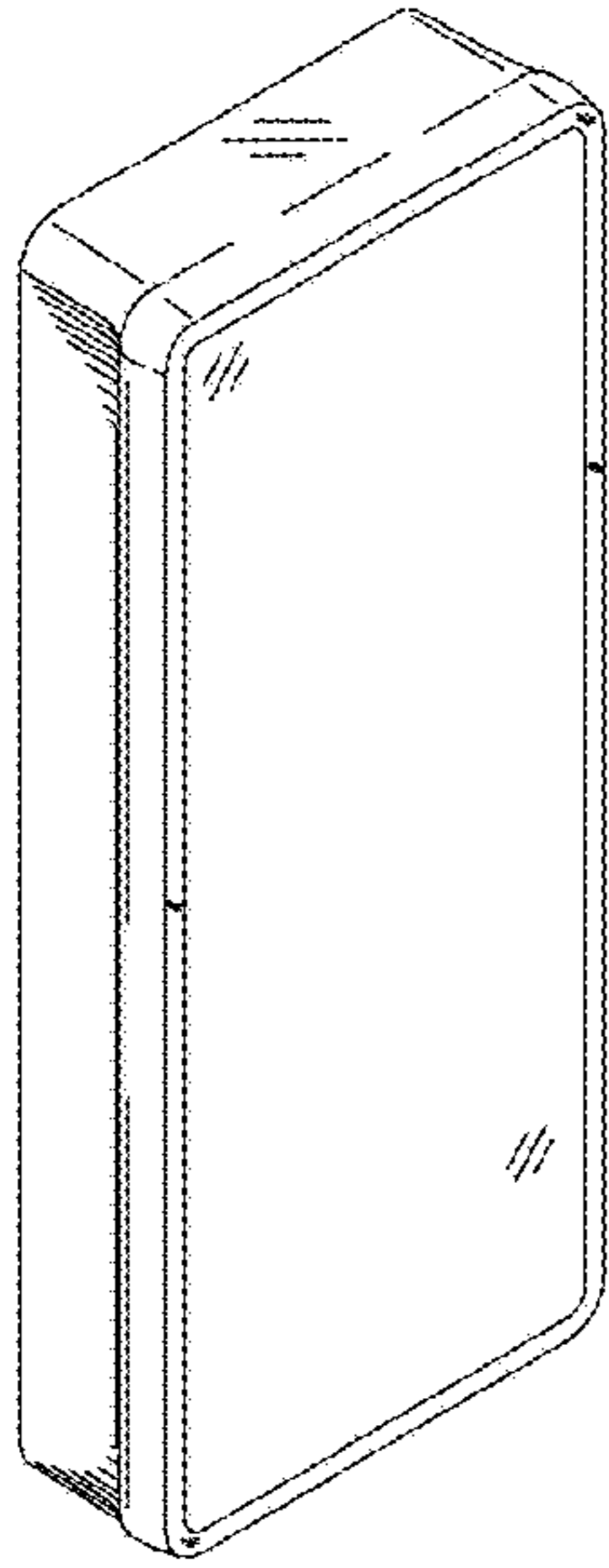

FIG. 7

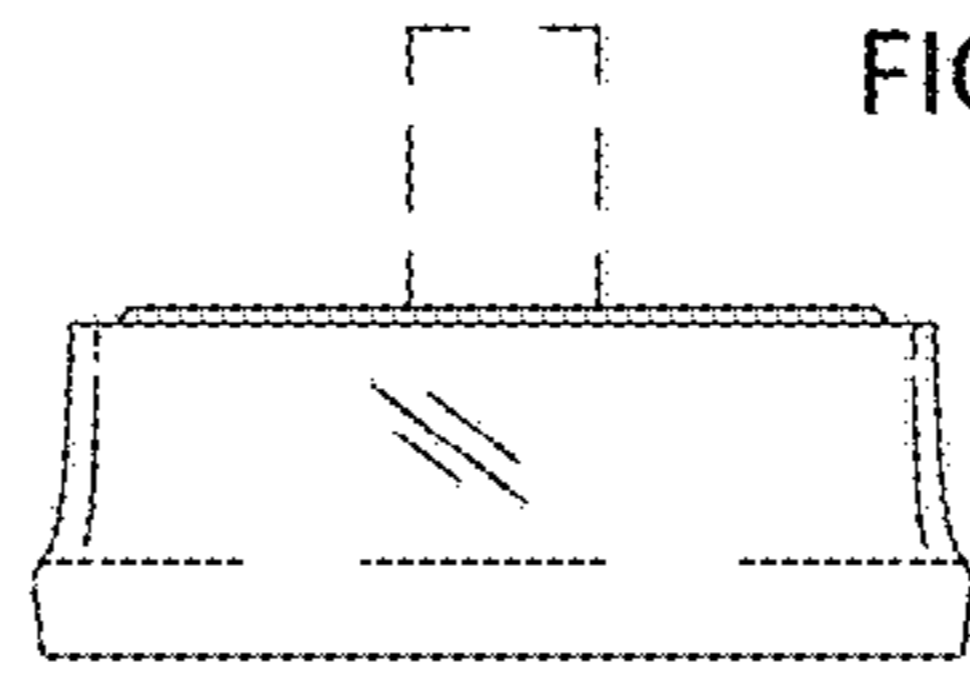

FIG. 8

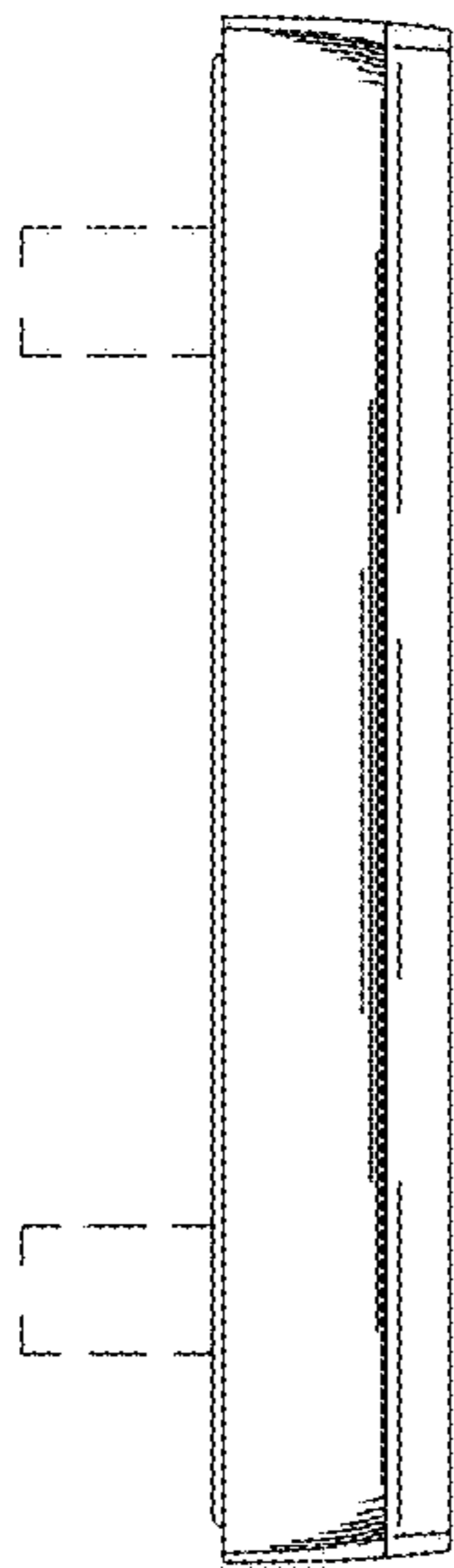

FIG. 9

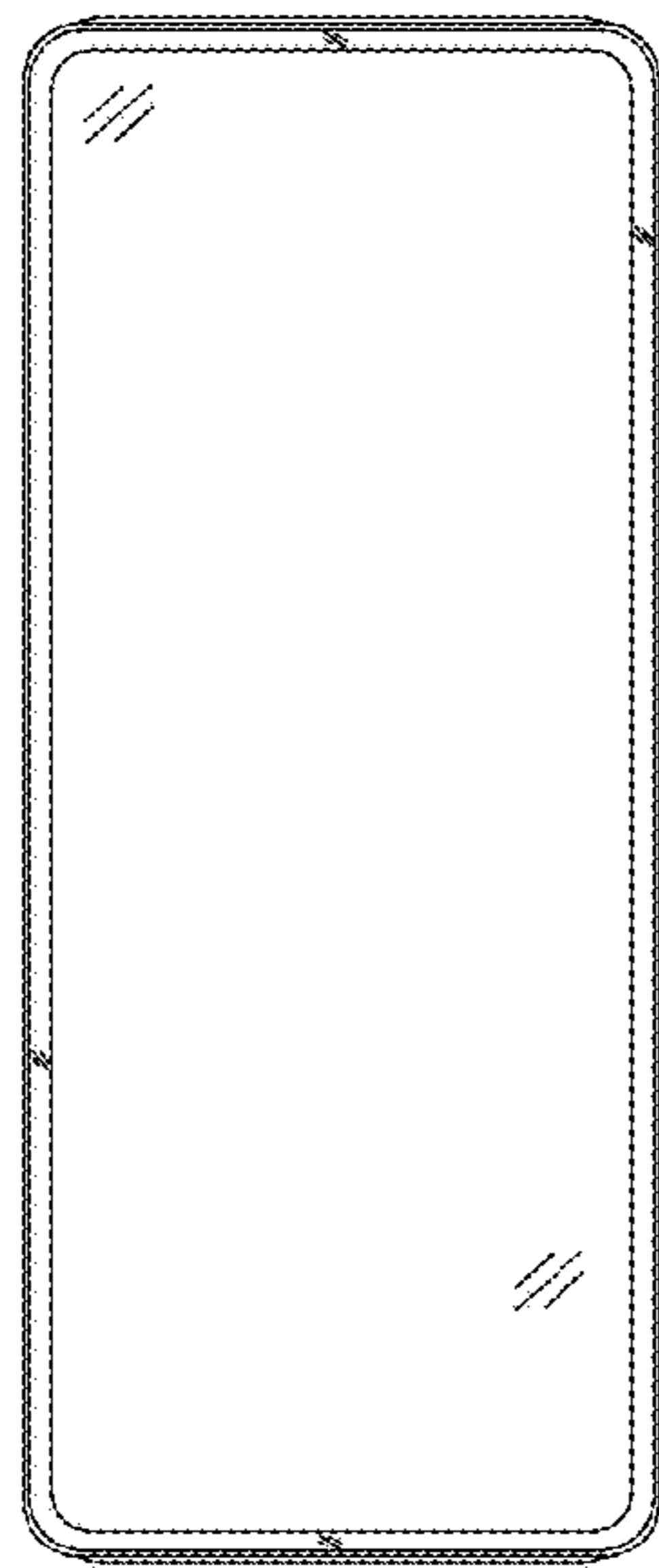

FIG. 10

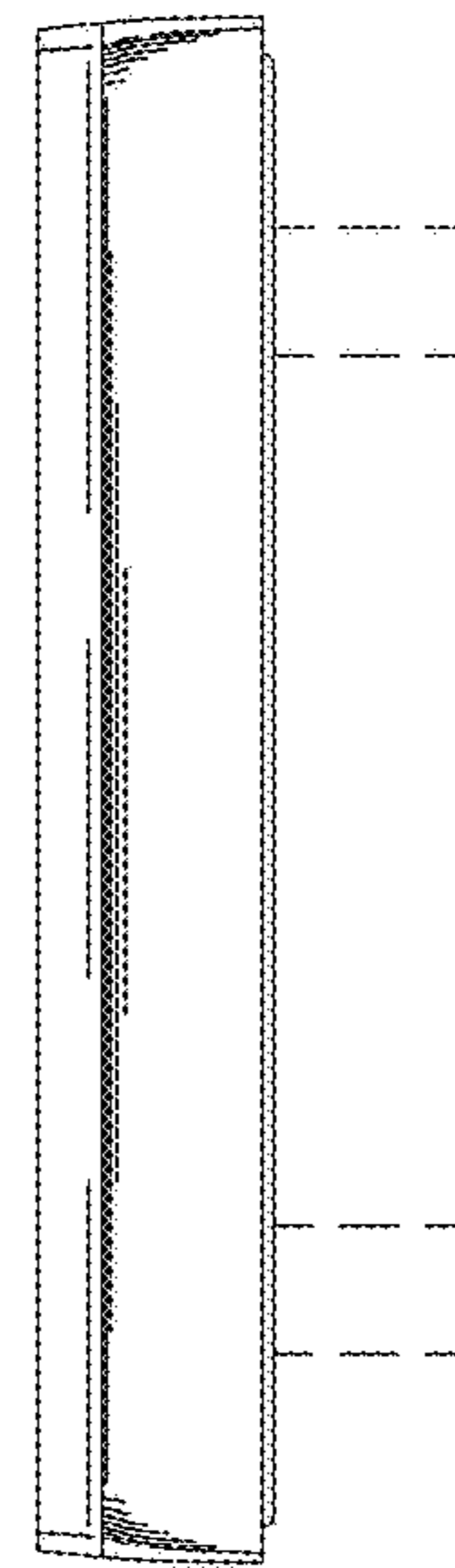

FIG. 11

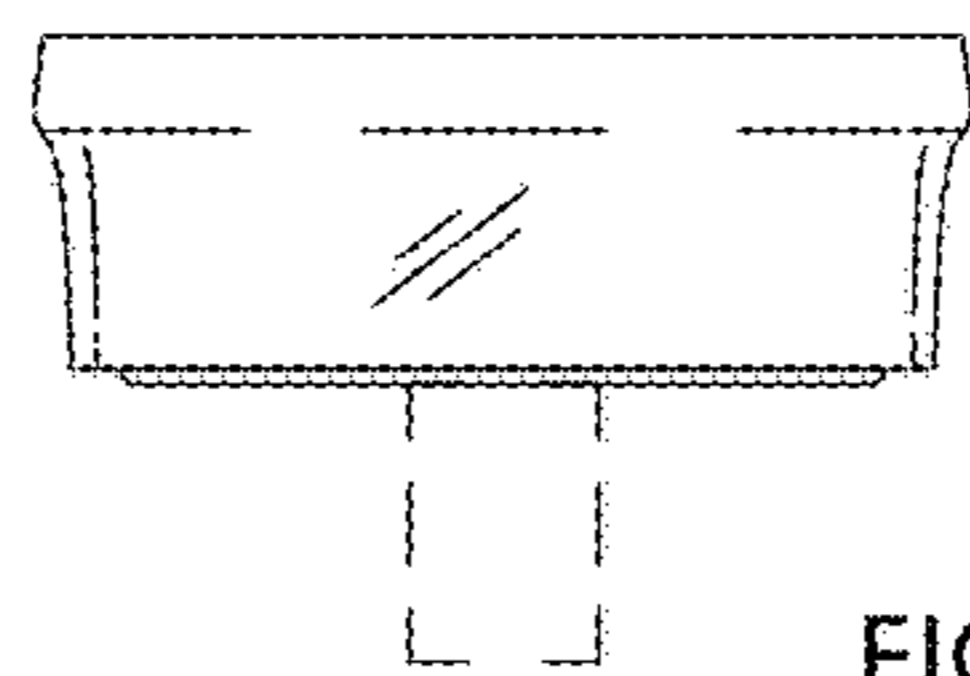

FIG. 12