



US00D836385S

(12) **United States Design Patent** (10) **Patent No.:** **US D836,385 S**
Arzunyan (45) **Date of Patent:** **** Dec. 25, 2018**

(54) **MINIATURE BLENDER**

(56) **References Cited**

(71) Applicant: **Rustam Arzunyan**, Newton Centre, MA (US)

U.S. PATENT DOCUMENTS

(72) Inventor: **Rustam Arzunyan**, Newton Centre, MA (US)

D279,346 S *	6/1985	Ruxton	D7/321
5,720,552 A *	2/1998	Schindlegger	A47G 19/2205 366/197
D665,222 S *	8/2012	Cerasani	D7/376
D729,579 S *	5/2015	Molayem	D7/507
D805,852 S *	12/2017	Seiders	D7/608
2016/0130052 A1 *	5/2016	Stenglein	A47J 43/0727 220/212

(**) Term: **15 Years**

(21) Appl. No.: **29/609,892**

* cited by examiner

(22) Filed: **Jul. 6, 2017**

(51) **LOC (11) Cl.** **31-00**

Primary Examiner — Ricky Pham

(52) **U.S. Cl.**

(74) *Attorney, Agent, or Firm* — Bay State IP, LLC

USPC **D7/378**; D7/376; D7/412; D7/413

(58) **Field of Classification Search**

(57) **CLAIM**

The ornamental design for a miniature blender, as shown and described.

USPC D7/309, 317, 372, 376–386, 412–413, D7/507, 602, 608, 629, 665–666, 669, D7/679, 693–694

DESCRIPTION

CPC A21C 1/02; A21C 1/04; A23N 1/00; A23N 1/02; A47G 19/2205; A47J 43/04; A47J 43/25; A47J 43/27; A47J 43/042; A47J 43/044; A47J 43/046; A47J 43/075; A47J 43/0722; A47J 43/0727; B01F 3/00; B01F 3/0807; B01F 3/0853; B01F 13/0059; B01F 13/0064; B02C 1/08; B02C 2/04; B02C 4/42; B02C 4/142; B02C 4/143; B02C 4/423; B02C 13/1835; B28C 5/10; B28C 5/12; B28C 5/14; B28C 5/16

FIG. 1 is a front perspective view of a miniature blender new design;
FIG. 2 is a back view thereof;
FIG. 3 is a front view thereof;
FIG. 4 is a left side view thereof;
FIG. 5 is a right side view thereof;
FIG. 6 is a top view thereof; and,
FIG. 7 is a bottom view thereof.

See application file for complete search history.

1 Claim, 4 Drawing Sheets

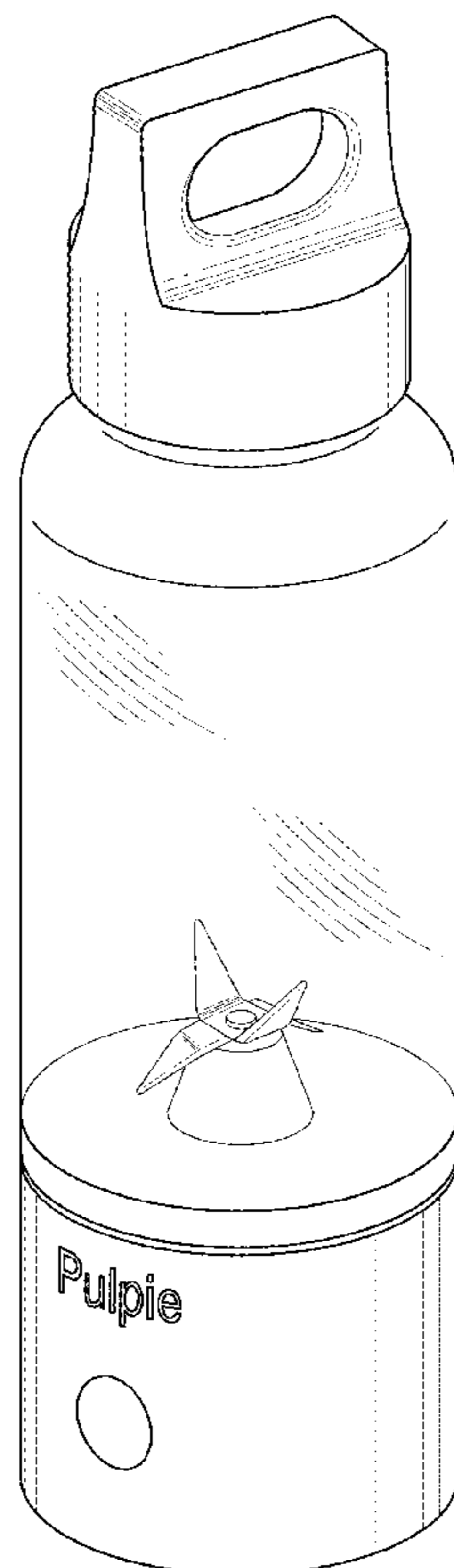

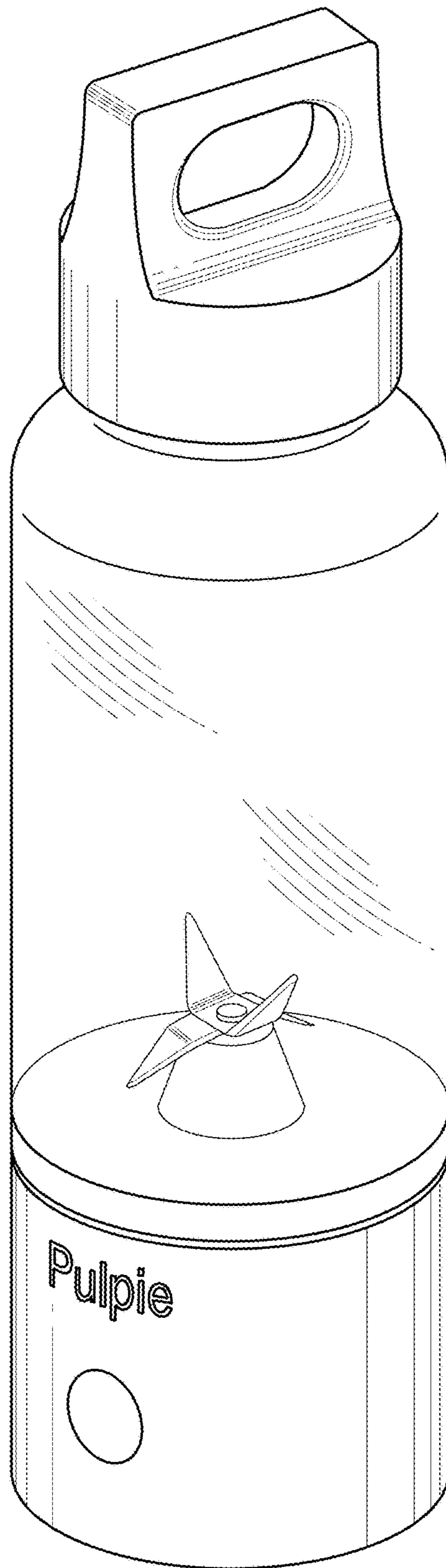

Fig. 1

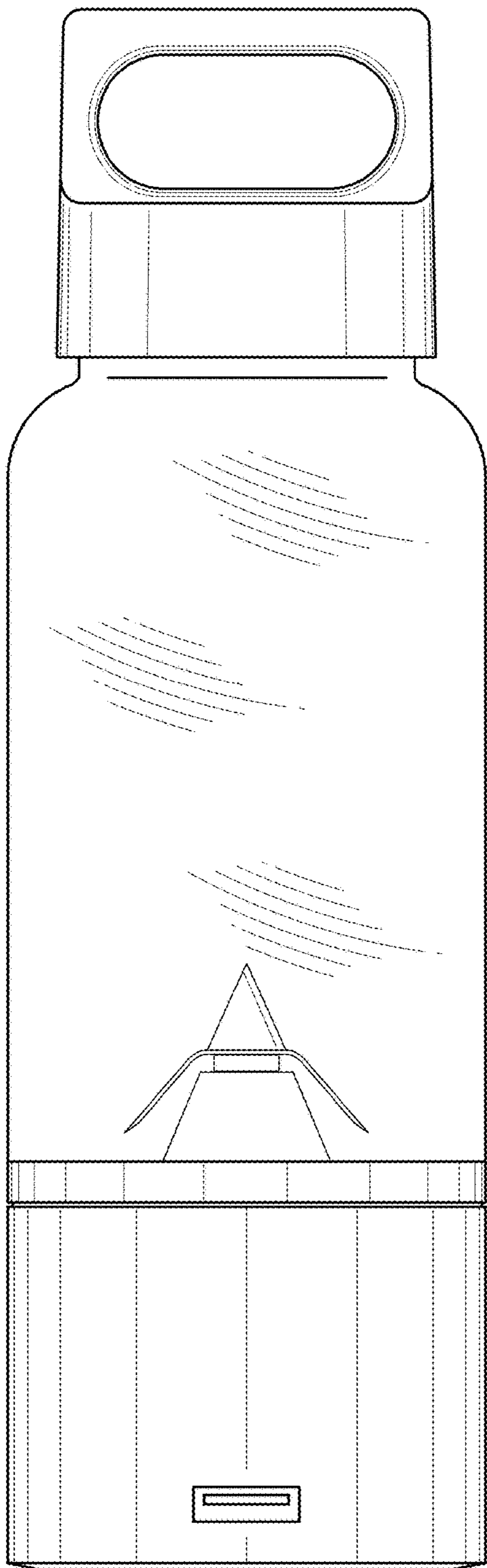

Fig. 2

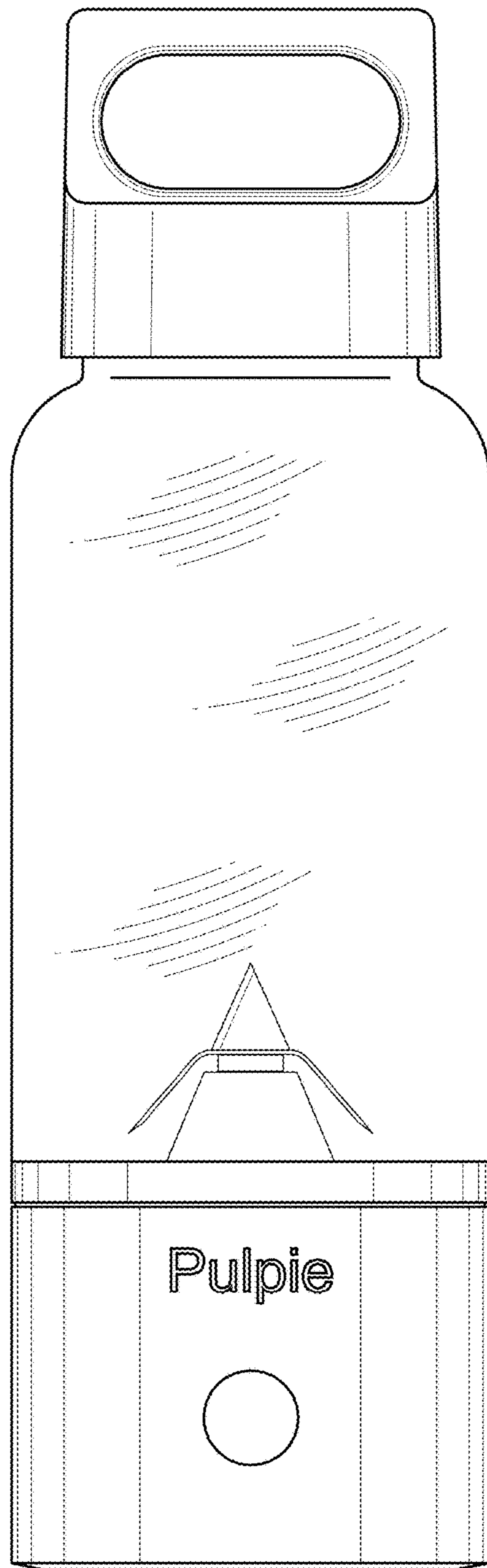

Fig. 3

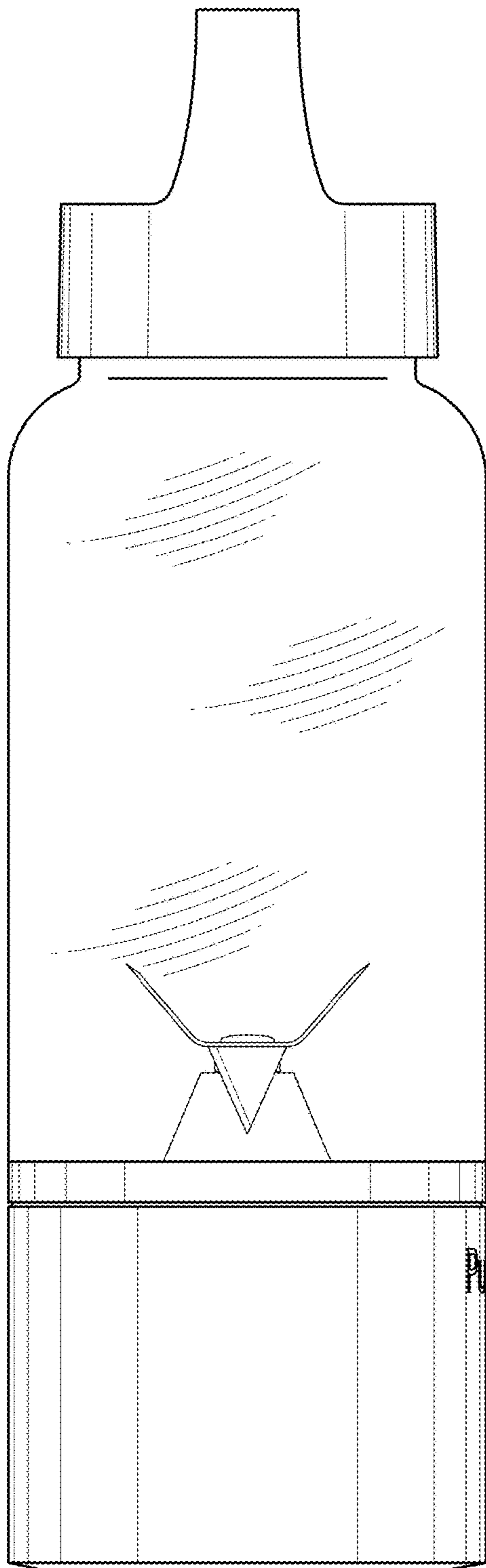

Fig. 4

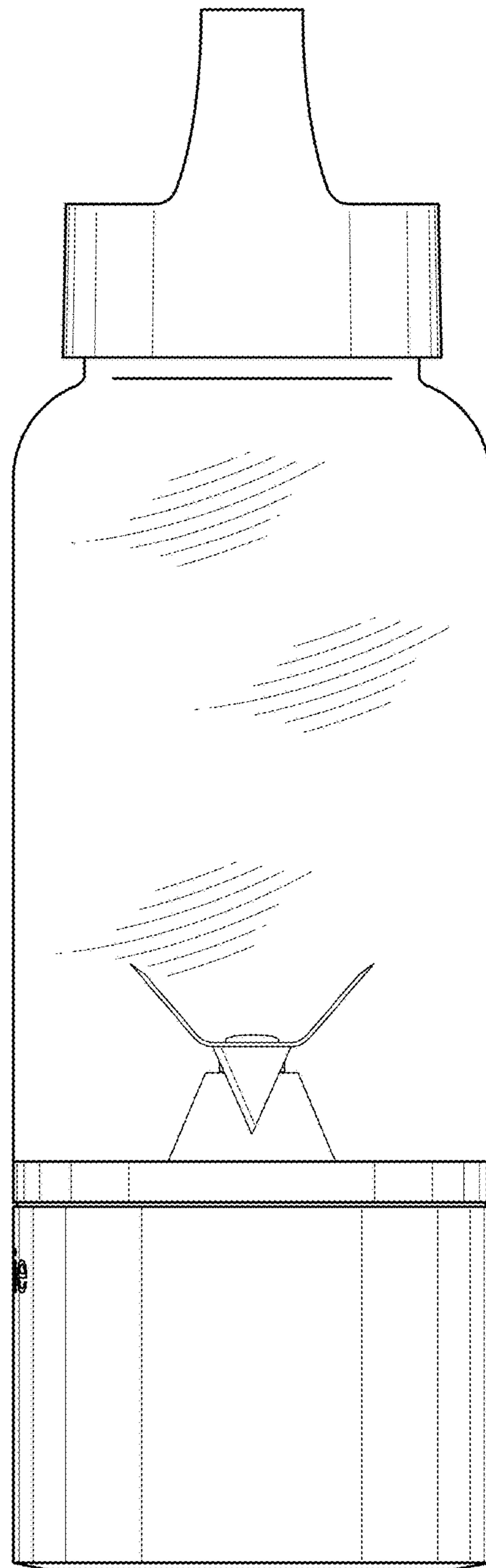

Fig. 5

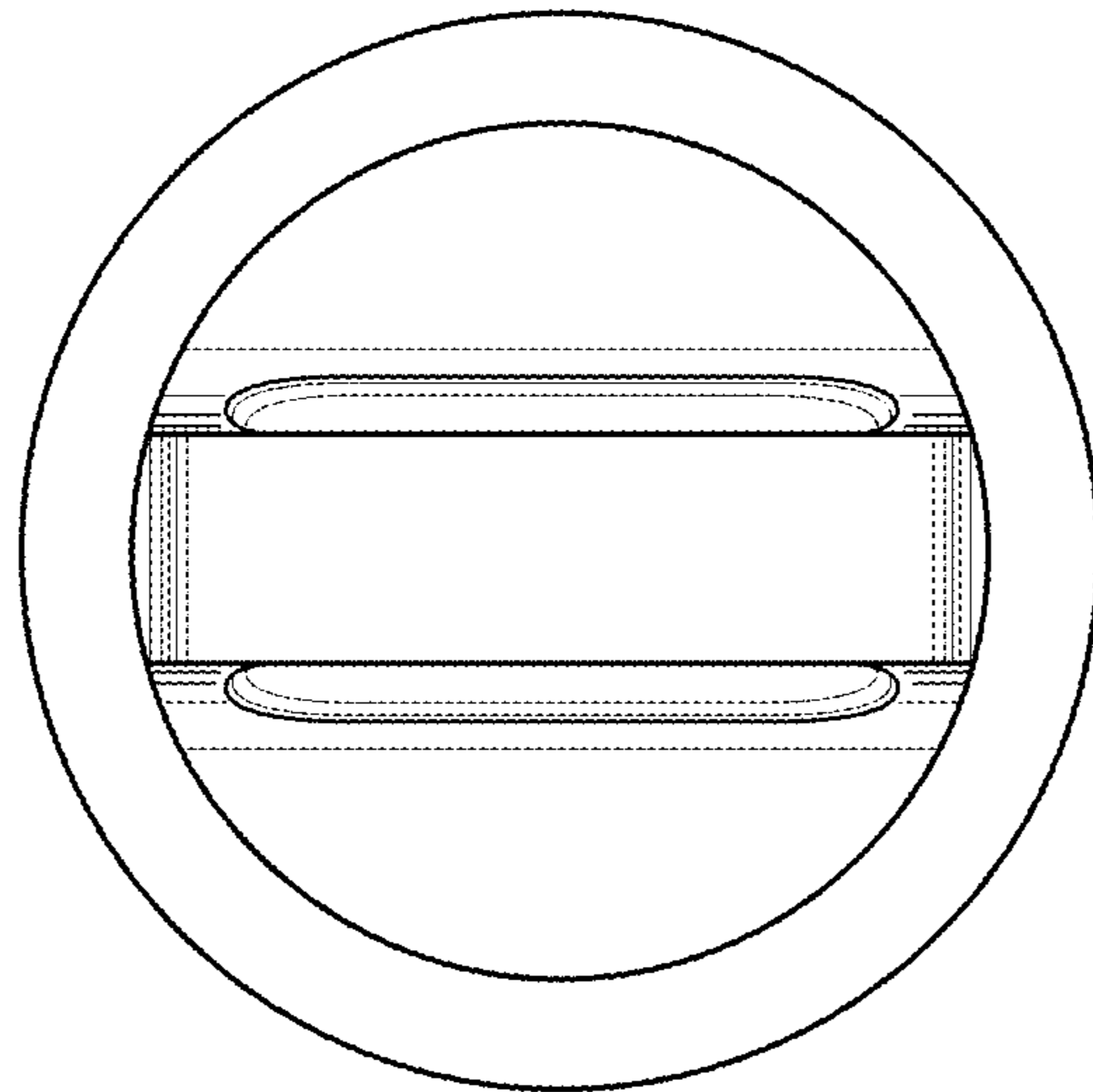

Fig. 6

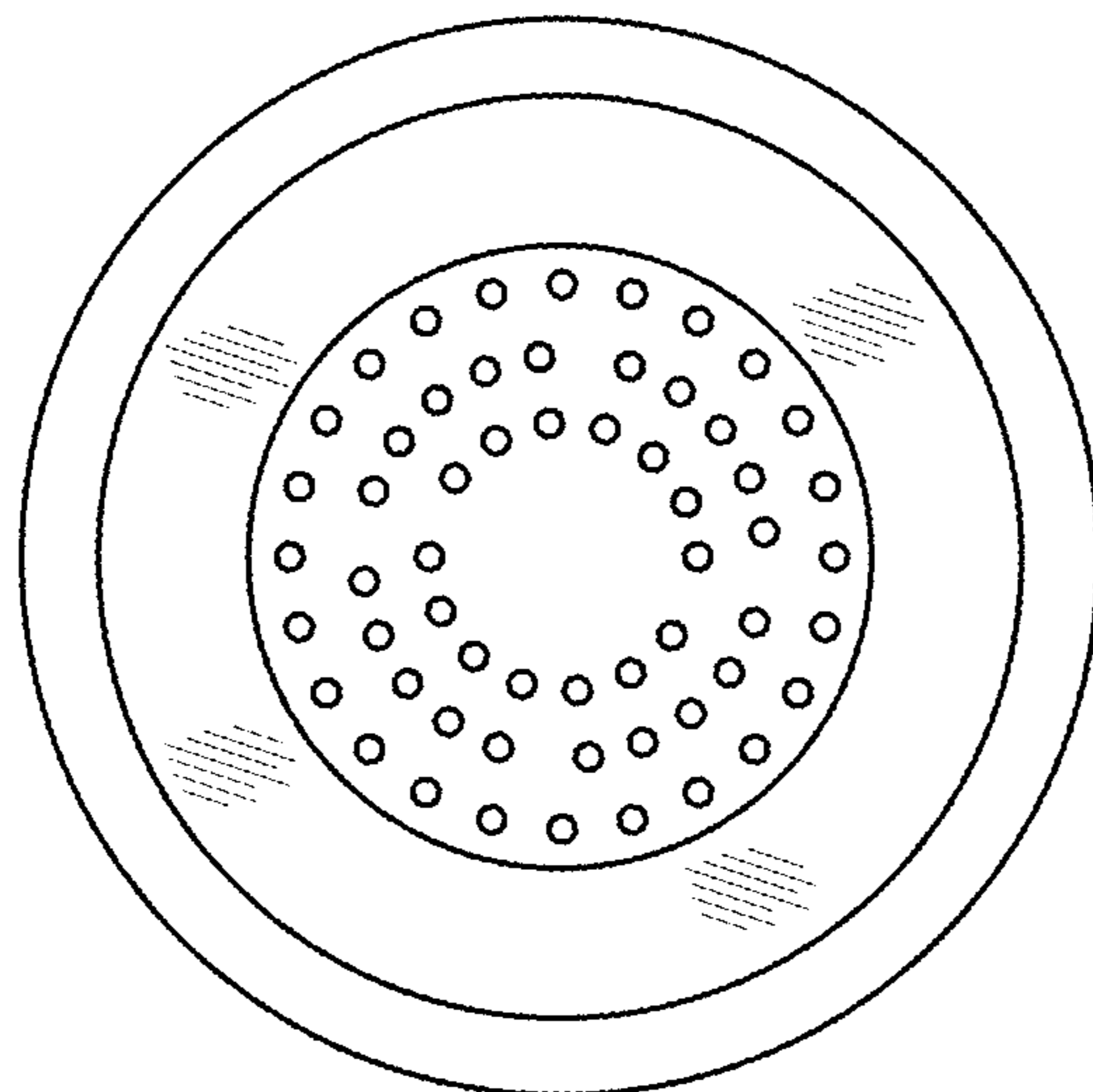

Fig. 7