



US00D836313S

(12) **United States Design Patent** (10) **Patent No.:** **US D836,313 S**  
**Woods et al.** (45) **Date of Patent:** **\*\* Dec. 25, 2018**

- (54) **SHOE**
- (71) Applicant: **TBL Licensing LLC**, Stratham, NH (US)
- (72) Inventors: **Suzanne Woods**, London (GB); **Dawn Mozina**, Bedford, NH (US)
- (73) Assignee: **TBL Licensing LLC**, Stratham, NH (US)
- (\*\*) Term: **15 Years**
- (21) Appl. No.: **29/561,926**
- (22) Filed: **Apr. 21, 2016**
- (51) **LOC (11) Cl.** ..... **02-04**
- (52) **U.S. Cl.**  
USPC ..... **D2/969**
- (58) **Field of Classification Search**  
USPC ..... D2/902, 906-907, 909-912, 916-918, D2/925-942, 943-946, 957-960, 964, D2/969, 970-974, 976-978  
CPC ... A43B 3/0047; A43B 3/0052; A43B 3/0057; A43B 3/0063; A43B 3/0068; A43B 3/0073; A43B 1/04; A43B 1/06; A43B 1/0036; A43B 1/0045; A43B 5/00; A43B 5/02; A43B 5/06; A43B 5/10; A43B 5/12; A43B 5/14; A43B 23/02; A43B 23/06; A43B 23/07; A43B 23/45; A43B 13/10; A43B 13/12; A43B 13/125; A43B 13/186; A43B 21/00; A43B 21/02; A43B 21/06; A43B 9/14; A43C 3/00; A43C 7/06  
See application file for complete search history.

D242,401 S \* 11/1976 Wunsch ..... D2/907  
D271,633 S \* 12/1983 Casetta ..... D2/902  
D326,763 S \* 6/1992 Holbrook ..... D2/907  
(Continued)

**OTHER PUBLICATIONS**

Timberland Men's Newport Bay Canvas Chukka Fashion Sneaker, as posted at Amazon.com [online], first available on Jan. 19, 2016, [site visited Aug. 30, 2017]. Available on the Internet, <URL: <https://www.amazon.com/Timberland-Newport-Bay-Canvas-Chukka/dp/B01710FVUA?th=1>>.\*

(Continued)

*Primary Examiner* — Jeffrey D Asch  
*Assistant Examiner* — Rebekah A Caruso  
(74) *Attorney, Agent, or Firm* — Lerner, David, Littenberg, Krumholz & Mentlik, LLP

(57) **CLAIM**

The ornamental design for a shoe, as shown and described.

**DESCRIPTION**

FIG. 1 is a front perspective view of our shoe, according to our the design;  
FIG. 2 is a front view thereof;  
FIG. 3 is a back view thereof;  
FIG. 4 is a right-side view thereof;  
FIG. 5 is a left-side view thereof;  
FIG. 6 is a top view thereof; and,  
FIG. 7 is a bottom view thereof.

The broken lines shown in the drawings, including the thin vertical broken lines shown on the upper edge of the midsole, represent portions of the shoe that form no part of the claimed design. The dot-dash lines in the drawings represent the bounds of the claimed design and form no part thereof. The longer, even-length broken lines within the shaded area of the shoe upper represent stitching that forms part of the claimed design. Areas of the design shown with a stipple fill illustrate a contrast in appearance.

**1 Claim, 6 Drawing Sheets**

(56) **References Cited**  
**U.S. PATENT DOCUMENTS**

- D237,426 S \* 11/1975 Thornberry ..... D2/907
- D237,427 S \* 11/1975 Thornberry ..... D2/907
- D238,626 S \* 2/1976 Senter ..... D2/907
- D239,478 S \* 4/1976 Senter ..... D2/907
- D239,479 S \* 4/1976 Senter ..... D2/907

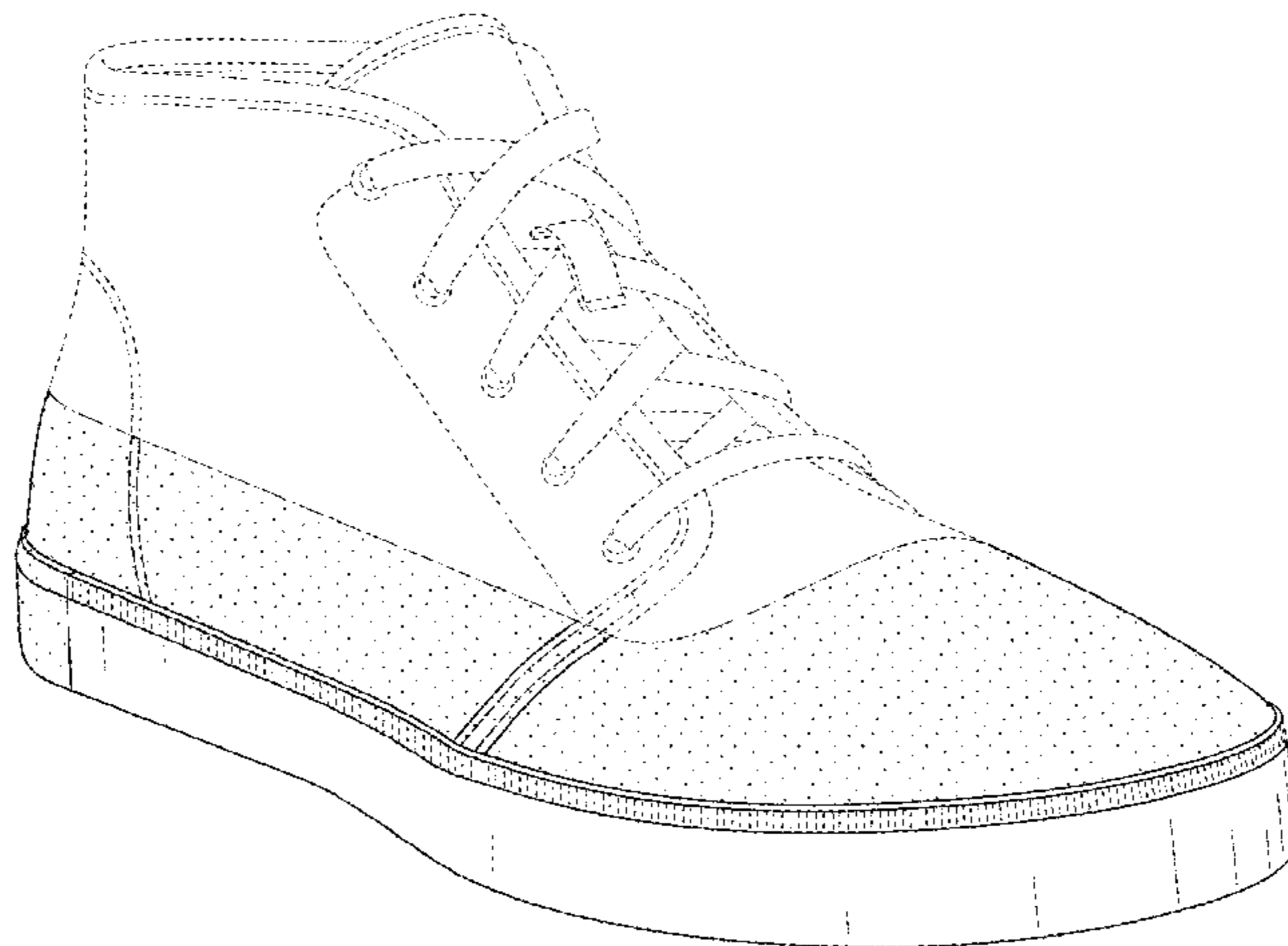

(56)

**References Cited**

## U.S. PATENT DOCUMENTS

D615,734	S	*	5/2010	Di Nucci	.....	D2/902
D651,388	S	*	1/2012	Van Zyll De Jong	.....	D2/969
D653,024	S	*	1/2012	LaRusso	.....	D2/897
D707,930	S	*	7/2014	Raysse	.....	D2/951
D729,503	S	*	5/2015	Carroll	.....	D2/902
D731,761	S	*	6/2015	Carroll	.....	D2/907
D738,084	S	*	9/2015	Feeney	.....	D2/907
D741,579	S	*	10/2015	McMillan	.....	D2/910
D765,376	S	*	9/2016	de Costa Pereira Machado	.....	D2/969
D769,586	S	*	10/2016	Buscemi	.....	D2/902
D771,924	S	*	11/2016	Radabaugh	.....	D2/970
D774,288	S	*	12/2016	Pina	.....	D2/908
D775,807	S	*	1/2017	Rauner	.....	D2/972
D776,911	S	*	1/2017	Blauer	.....	D2/973
D776,912	S	*	1/2017	Heinrich	.....	D2/973
D779,189	S	*	2/2017	Engel	.....	D2/972
D785,295	S	*	5/2017	Carroll	.....	D2/902
D792,683	S	*	7/2017	Carroll	.....	D2/902
D793,677	S	*	8/2017	Slimane	.....	D2/902

## OTHER PUBLICATIONS

“How Timberland Is Making a Difference With Shoes Made From Recycled Trash,” The Timberland Men’s Newport Bay Canvas Chukka and Hiker Chukka pictured therein, as posted at FootwearNews.com [online], posted on Mar. 3, 2017, [site visited Aug. 30, 2017]. Available on the Internet, <URL: <http://footwearnews.com/2017/focus/athletic-outdoor/timberland-thr>.\*

\* cited by examiner



FIG. 1

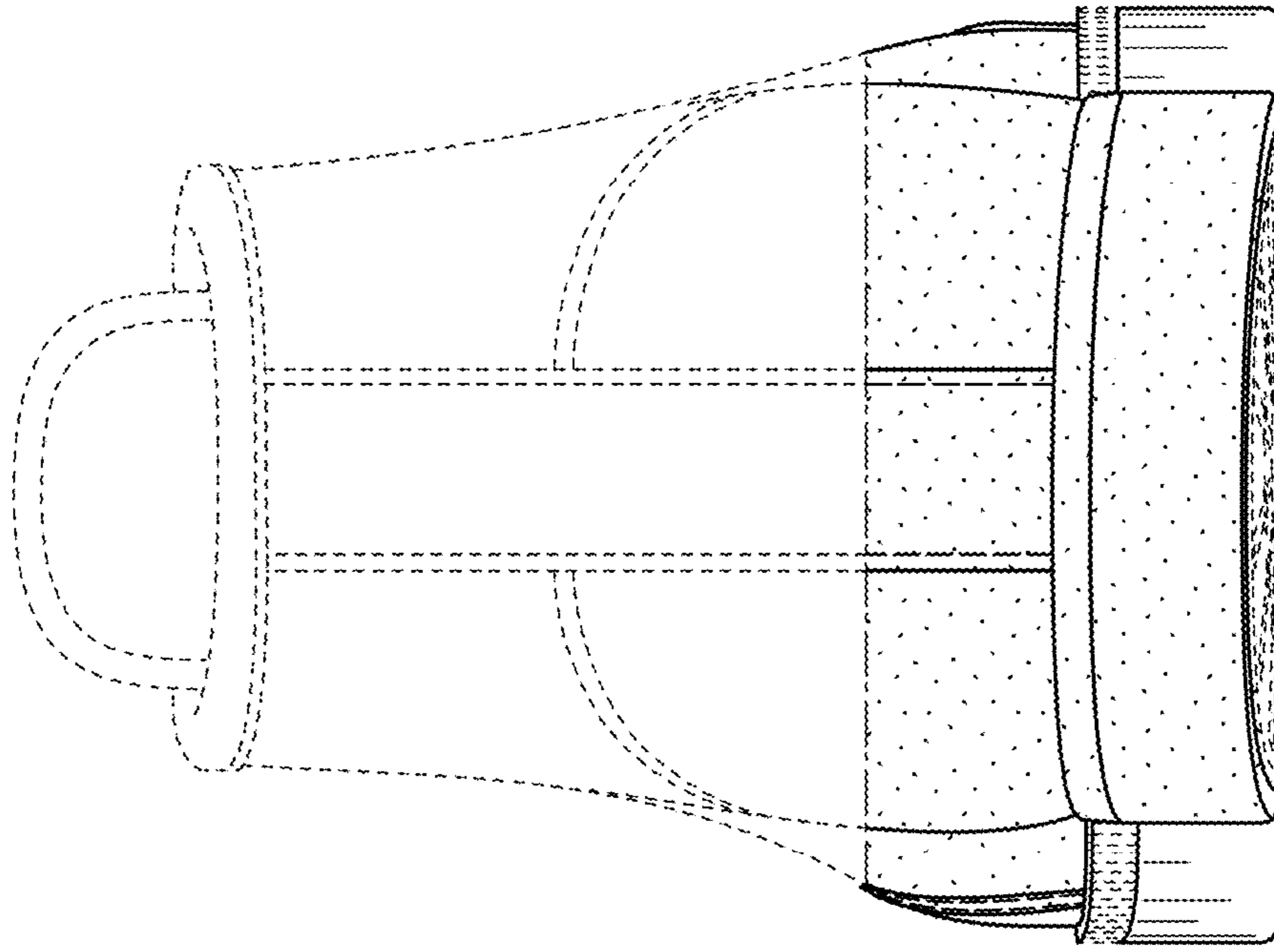

FIG. 3

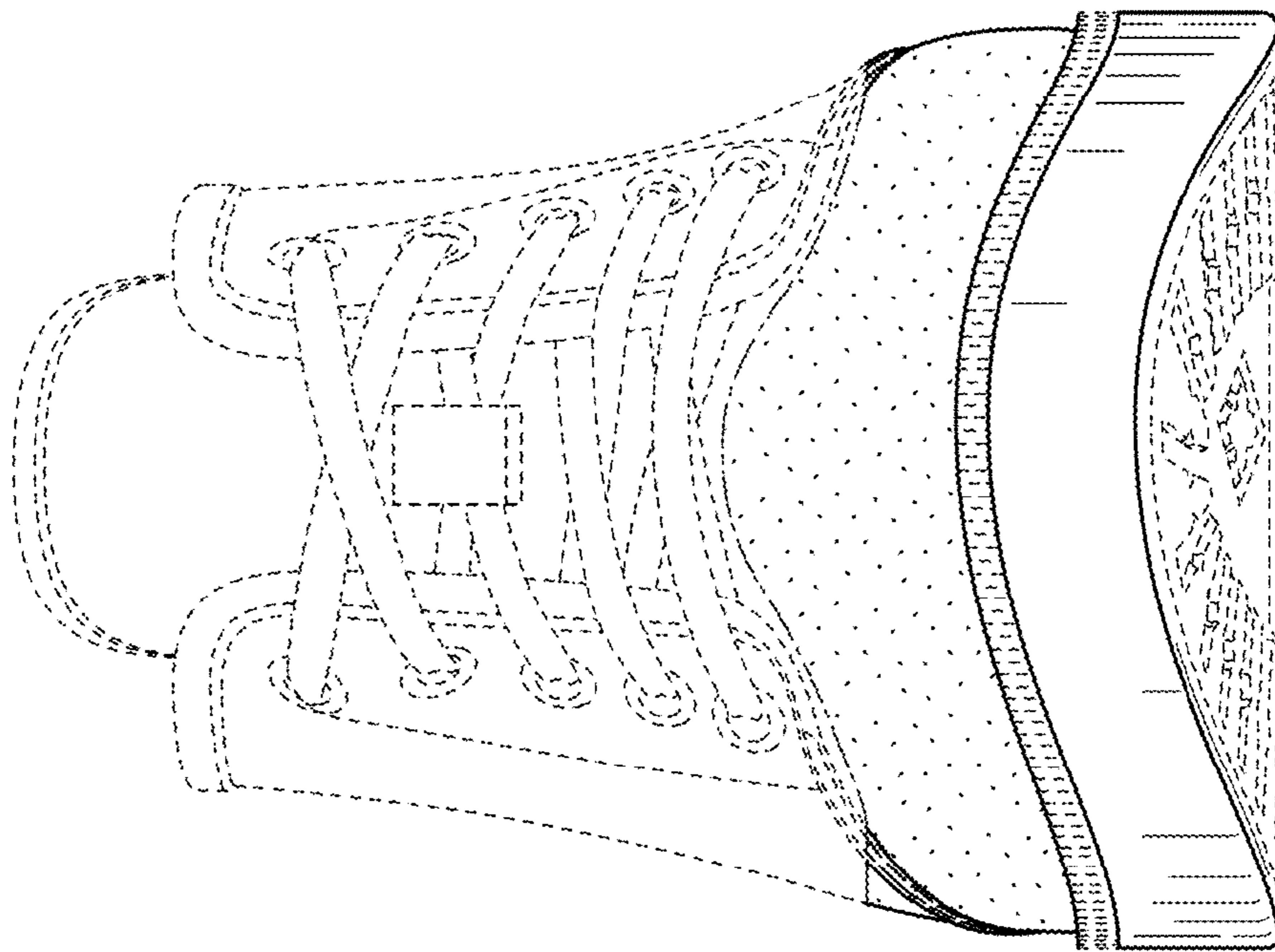

FIG. 2

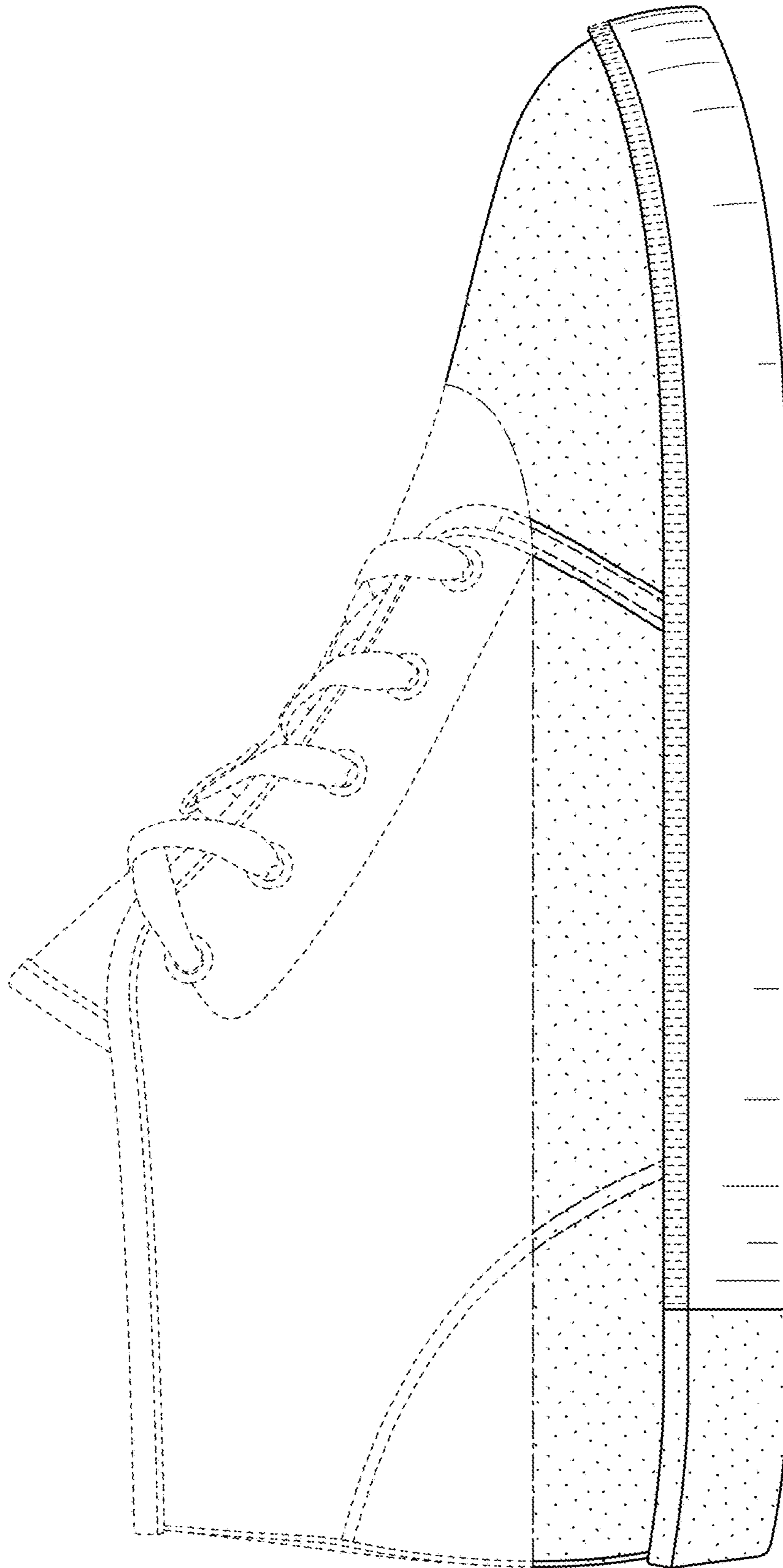

FIG. 4

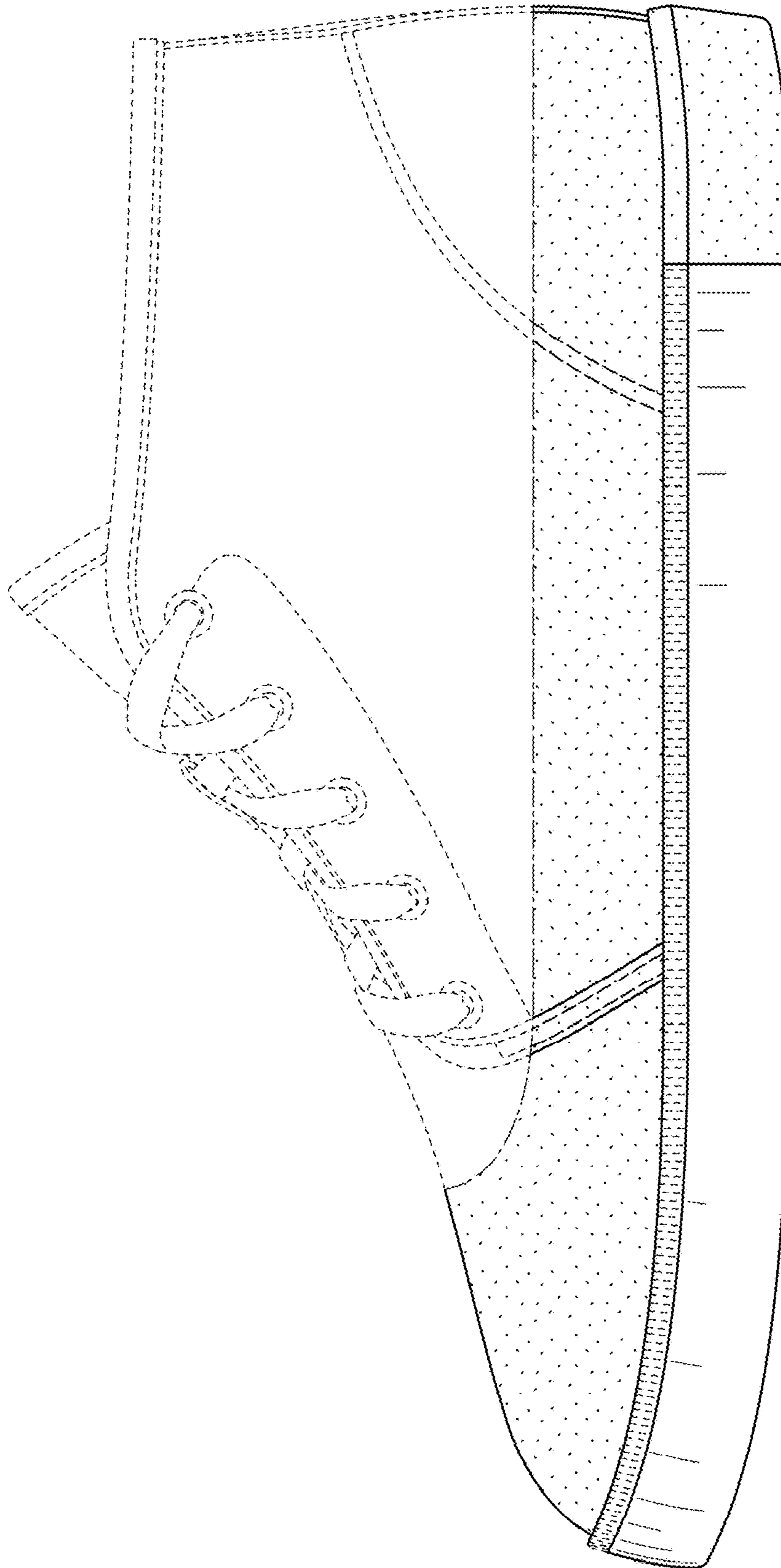

FIG. 5

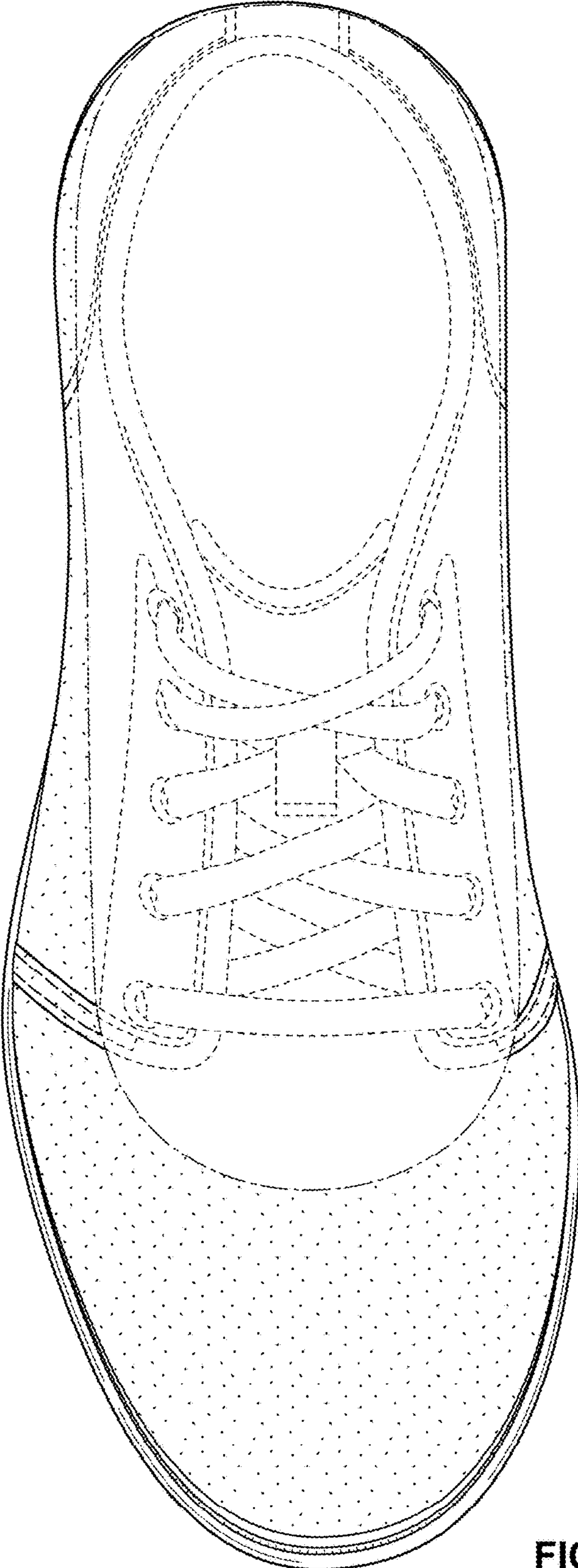

FIG. 6

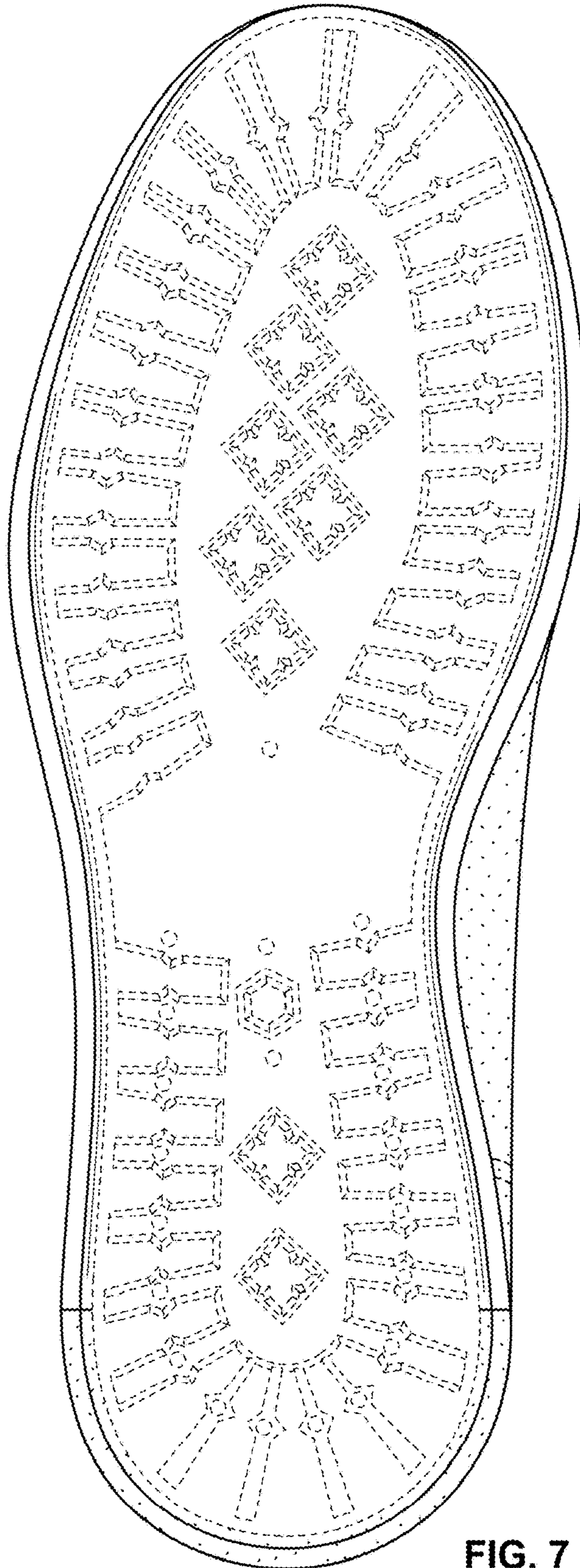

FIG. 7