



US00D836176S

(12) **United States Design Patent**  
**Desrochers**

(10) **Patent No.:** **US D836,176 S**

(45) **Date of Patent:** **\*\* Dec. 18, 2018**

(54) **BLADE HOLDER FOR AN ICE SKATE**

(71) Applicant: **BAUER HOCKEY LTD.**, Blainville  
(CA)

(72) Inventor: **Charles-Antoine Desrochers**, Prevost  
(CA)

(73) Assignee: **BAUER HOCKEY, LLC**, Exeter, NH  
(US)

(\*\*) Term: **15 Years**

(21) Appl. No.: **29/626,741**

(22) Filed: **Nov. 20, 2017**

**Related U.S. Application Data**

(62) Division of application No. 29/505,582, filed on Dec. 23, 2015, now Pat. No. Des. 806,194.

(51) **LOC (11) Cl.** ..... **21-02**

(52) **U.S. Cl.**  
USPC ..... **D21/761; D21/771**

(58) **Field of Classification Search**  
USPC ..... D21/760, 761, 762, 771, 772, 776;  
280/7.13, 11.12, 11.15, 11.14, 11.17,  
280/11.18, 11.223, 11.3, 825, 841  
CPC .... A63C 1/00; A63C 1/30; A63C 1/32; A63C  
1/34; A63C 1/40; A63C 3/00; A63C  
17/00; A63C 17/18; A63C 17/20  
See application file for complete search history.

(56) **References Cited**

**U.S. PATENT DOCUMENTS**

405,779 A \* 6/1889 Knerr ..... A63C 1/30  
280/11.12  
D248,583 S \* 7/1978 Zuuring ..... D21/761  
4,150,837 A \* 4/1979 Zuuring ..... A63C 1/02  
280/11.12

D286,903 S \* 11/1986 Olivieri ..... D21/761  
D305,560 S \* 1/1990 Hoshizaki ..... D2/904  
D416,599 S \* 11/1999 Reynolds ..... D21/761  
D486,196 S \* 2/2004 Lefebvre ..... D21/761  
D488,845 S \* 4/2004 Labonte ..... D21/761  
D490,131 S \* 5/2004 LaBonte ..... D21/761  
D533,246 S \* 12/2006 Koyess ..... D21/771

(Continued)

*Primary Examiner* — Cynthia M. Chin

(57) **CLAIM**

I claim the ornamental design for a blade holder for an ice skate, as shown and described.

**DESCRIPTION**

FIG. 1 is a perspective view of a blade holder for an ice skate in accordance with a first embodiment of the design; FIG. 2 is another perspective view of the blade holder of FIG. 1; FIG. 3 is a lateral side elevation view of the blade holder of FIG. 1; FIG. 4 is a medial side elevation view of the blade holder of FIG. 1; FIG. 5 is a front end view of the blade holder of FIG. 1; FIG. 6 is a rear end view of the blade holder of FIG. 1; FIG. 7 is a perspective view of a blade holder for an ice skate in accordance with a second embodiment of the design; FIG. 8 is another perspective view of the blade holder of FIG. 7; FIG. 9 is a lateral side elevation view of the blade holder of FIG. 7; FIG. 10 is a medial side elevation view of the blade holder of FIG. 7; FIG. 11 is a front end view of the blade holder of FIG. 7; and, FIG. 12 is a rear end view of the blade holder of FIG. 7. The broken lines shown are included for the purpose of illustrating portions of the article which form no part of the claimed design.

**1 Claim, 8 Drawing Sheets**

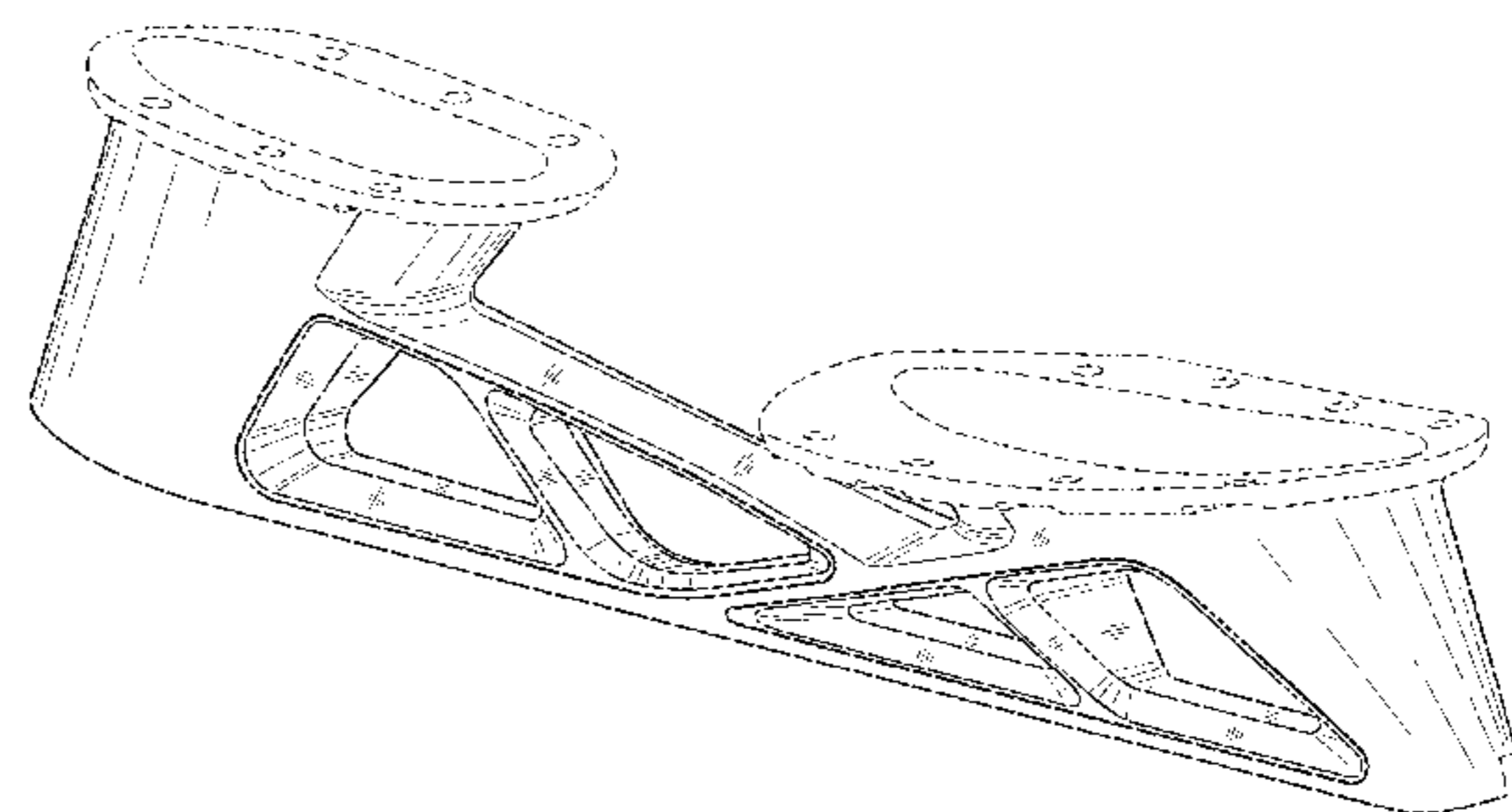
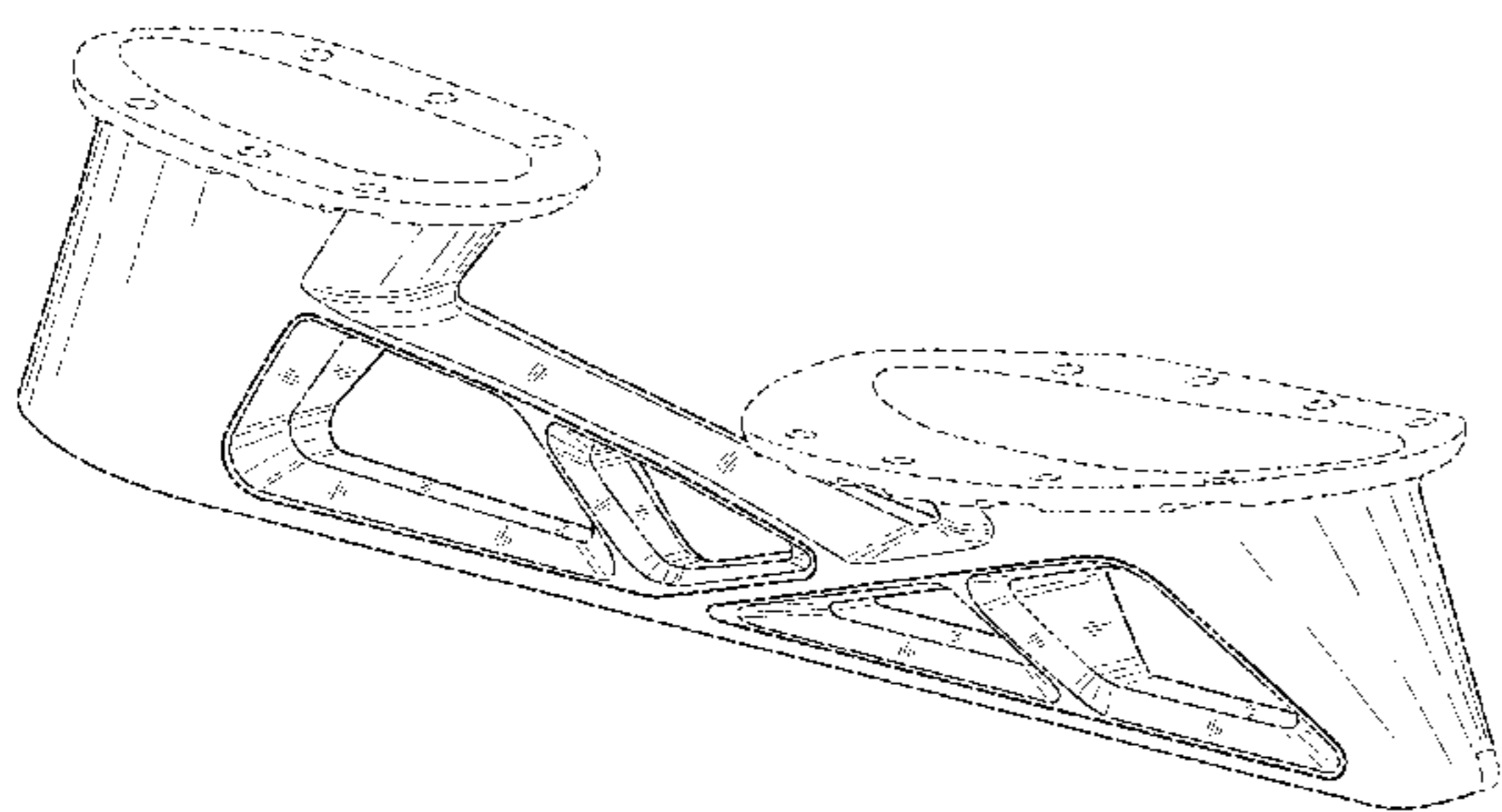

(56)

**References Cited**

U.S. PATENT DOCUMENTS

7,543,826	B2 *	6/2009	Labonte .....	A63C 1/02 280/11.12
7,628,405	B2 *	12/2009	Smith, II .....	A63C 1/30 280/11.12
D641,060	S *	7/2011	Boucher .....	D21/771
8,454,030	B2 *	6/2013	Corbeil .....	A63C 1/303 280/10
2011/0101665	A1 *	5/2011	Van Horne .....	A43B 5/1691 280/841
2014/0033575	A1 *	2/2014	Cruikshank .....	A43B 23/26 36/116
2014/0250733	A1 *	9/2014	Cruikshank .....	A43B 5/1625 36/115

\* cited by examiner

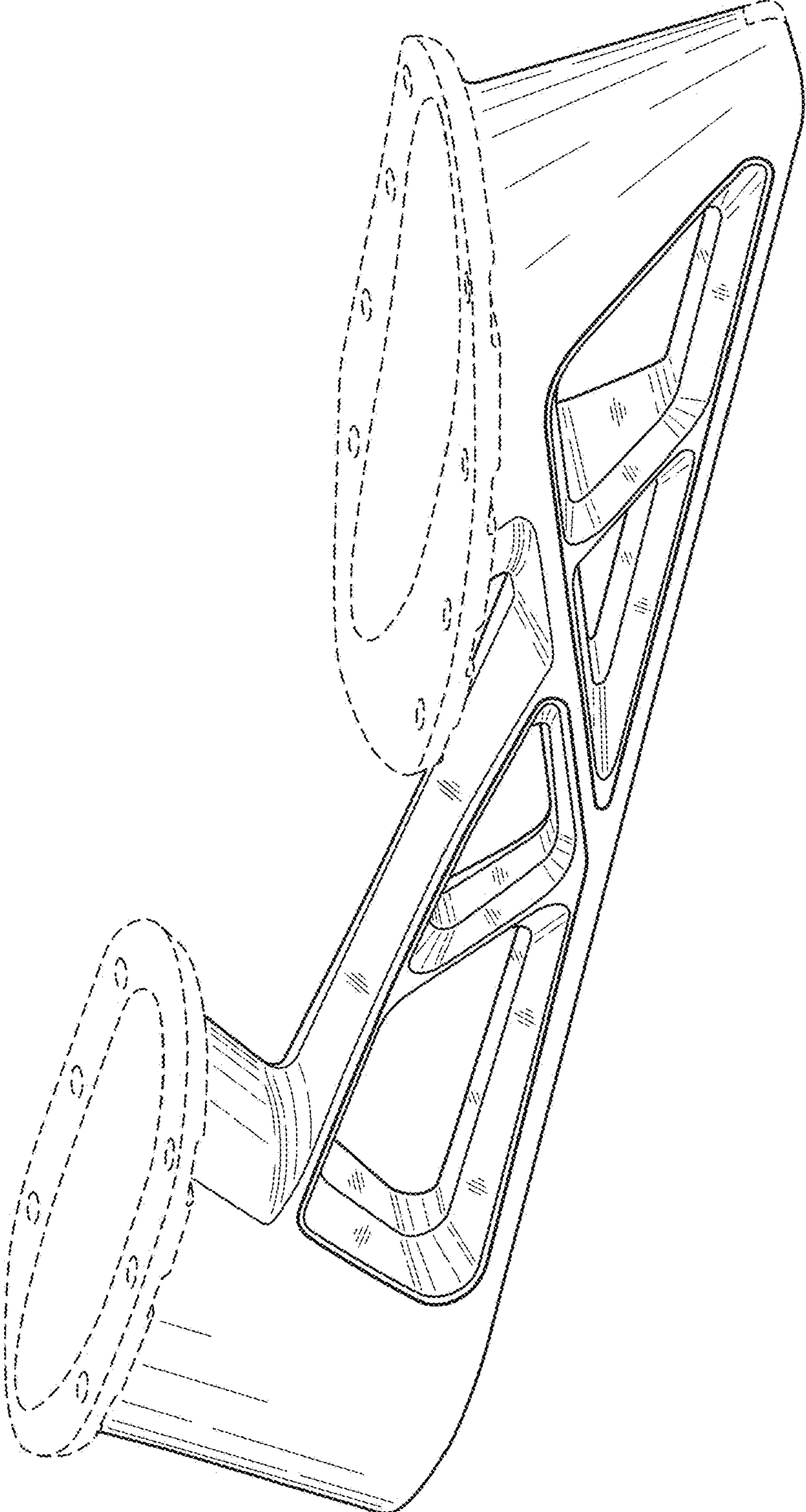

FIG. 1

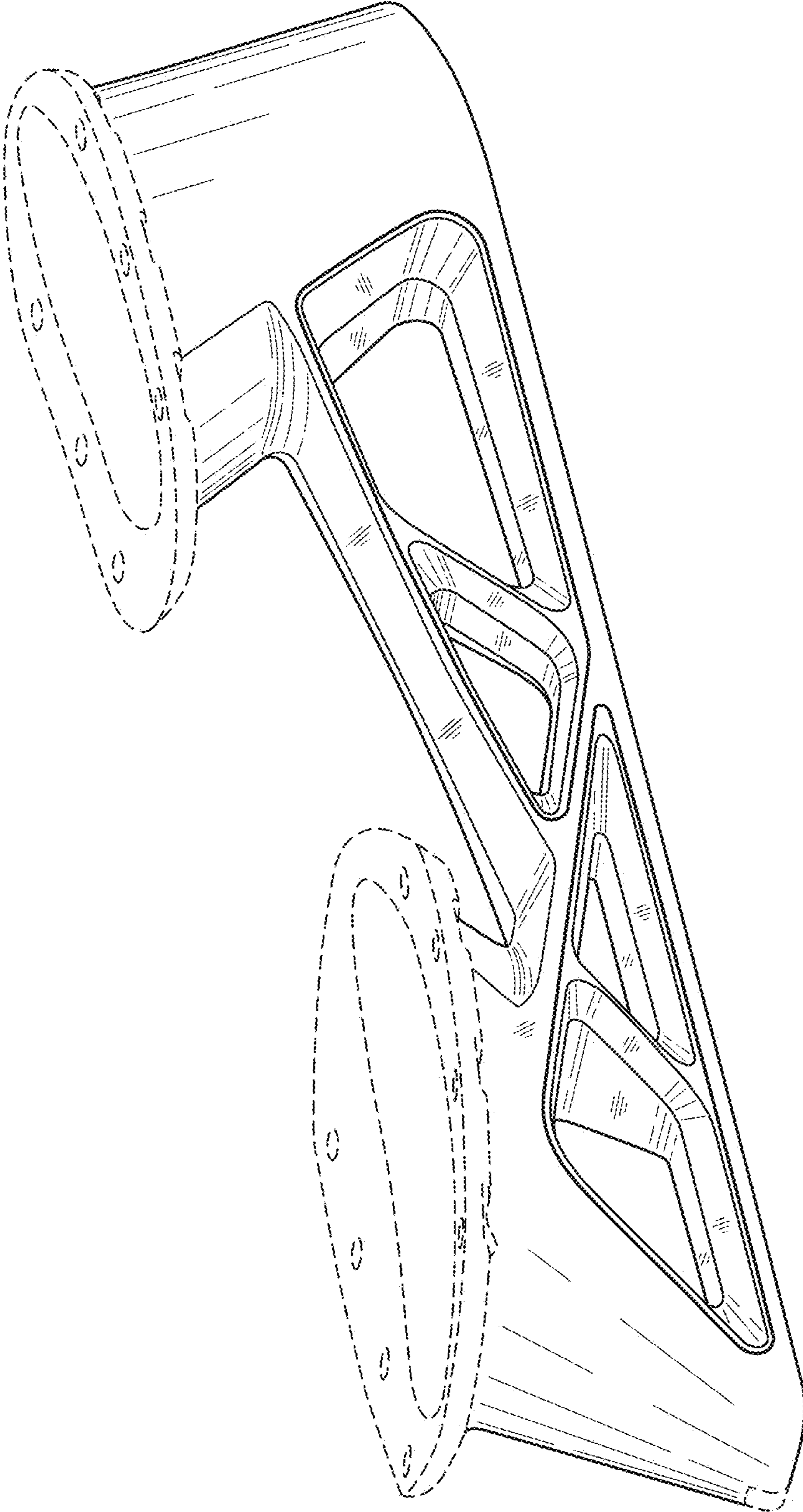

FIG. 2

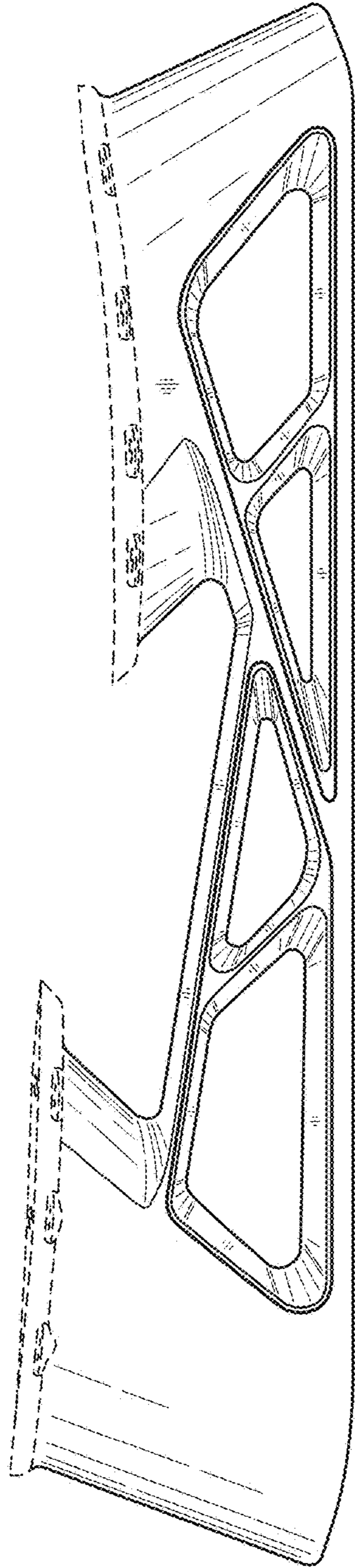

FIG. 3

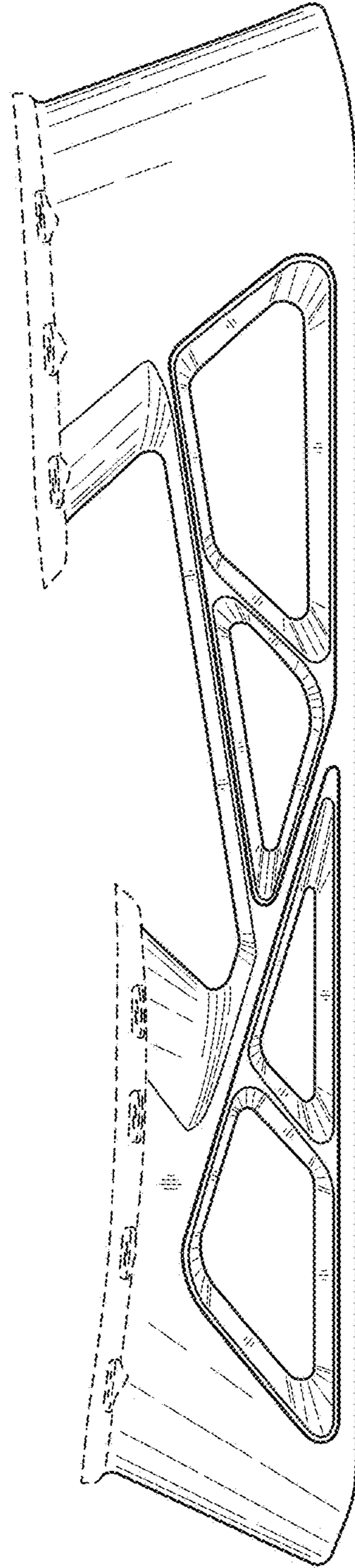

FIG. 4

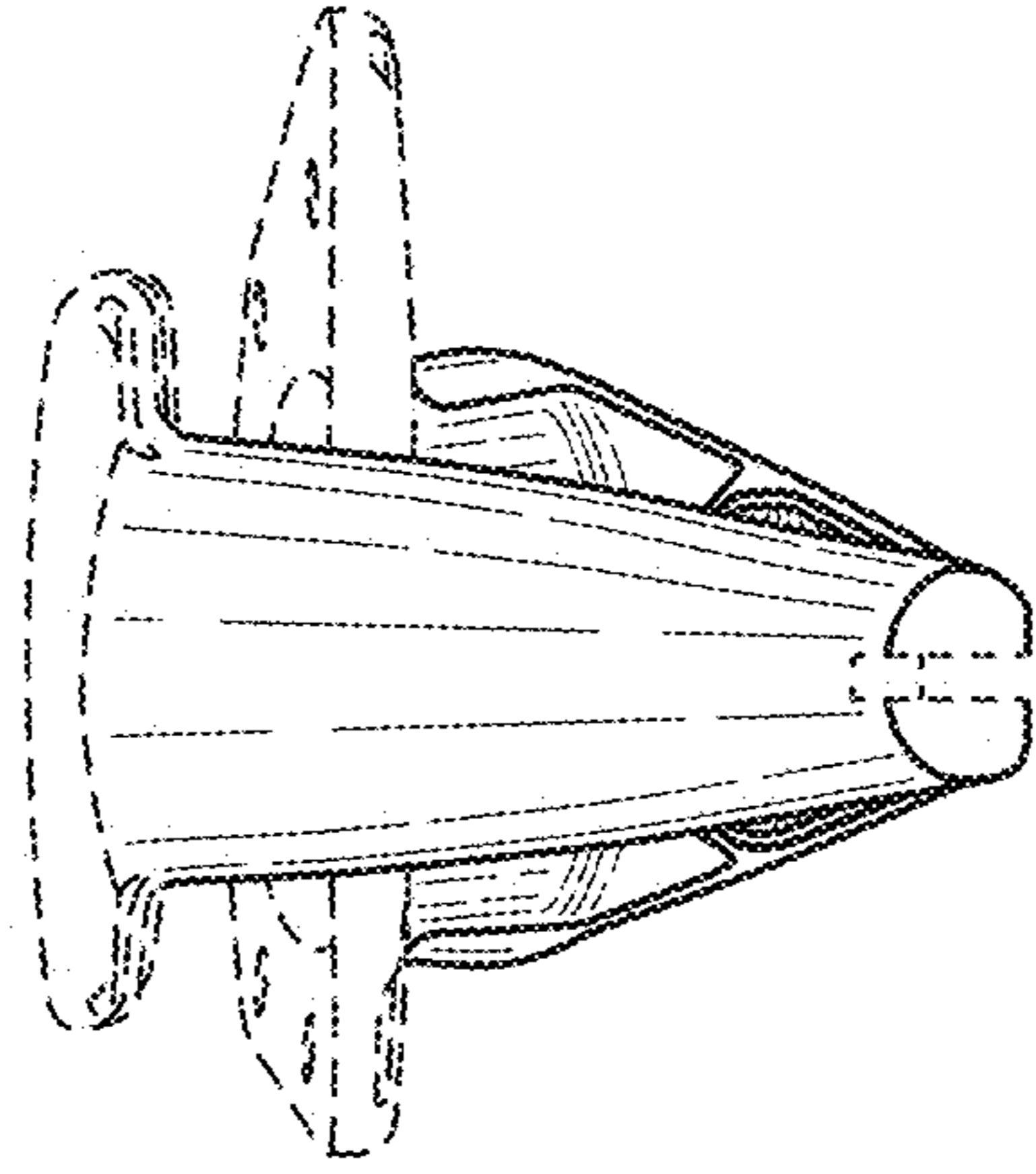

FIG. 5

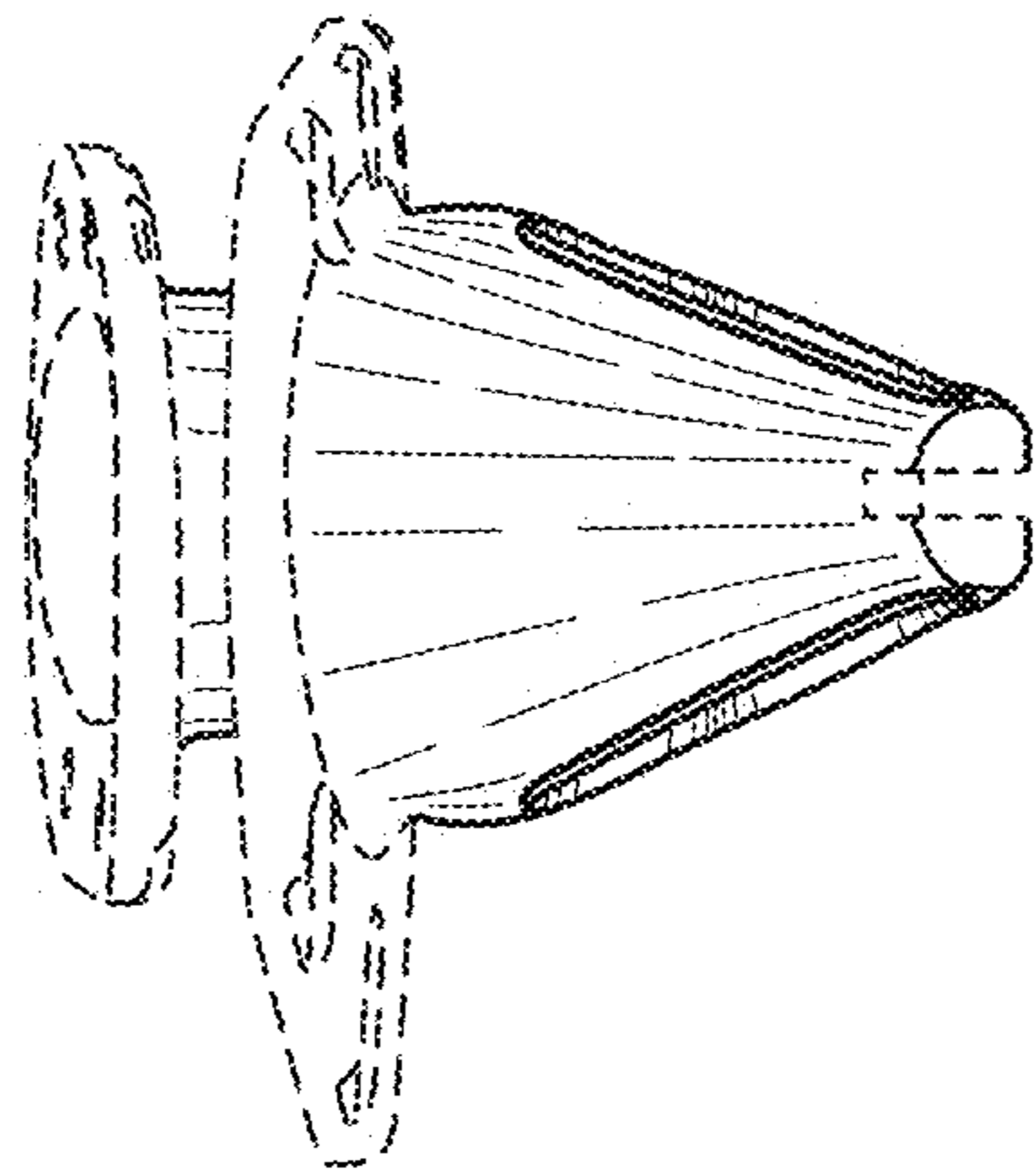

FIG. 6

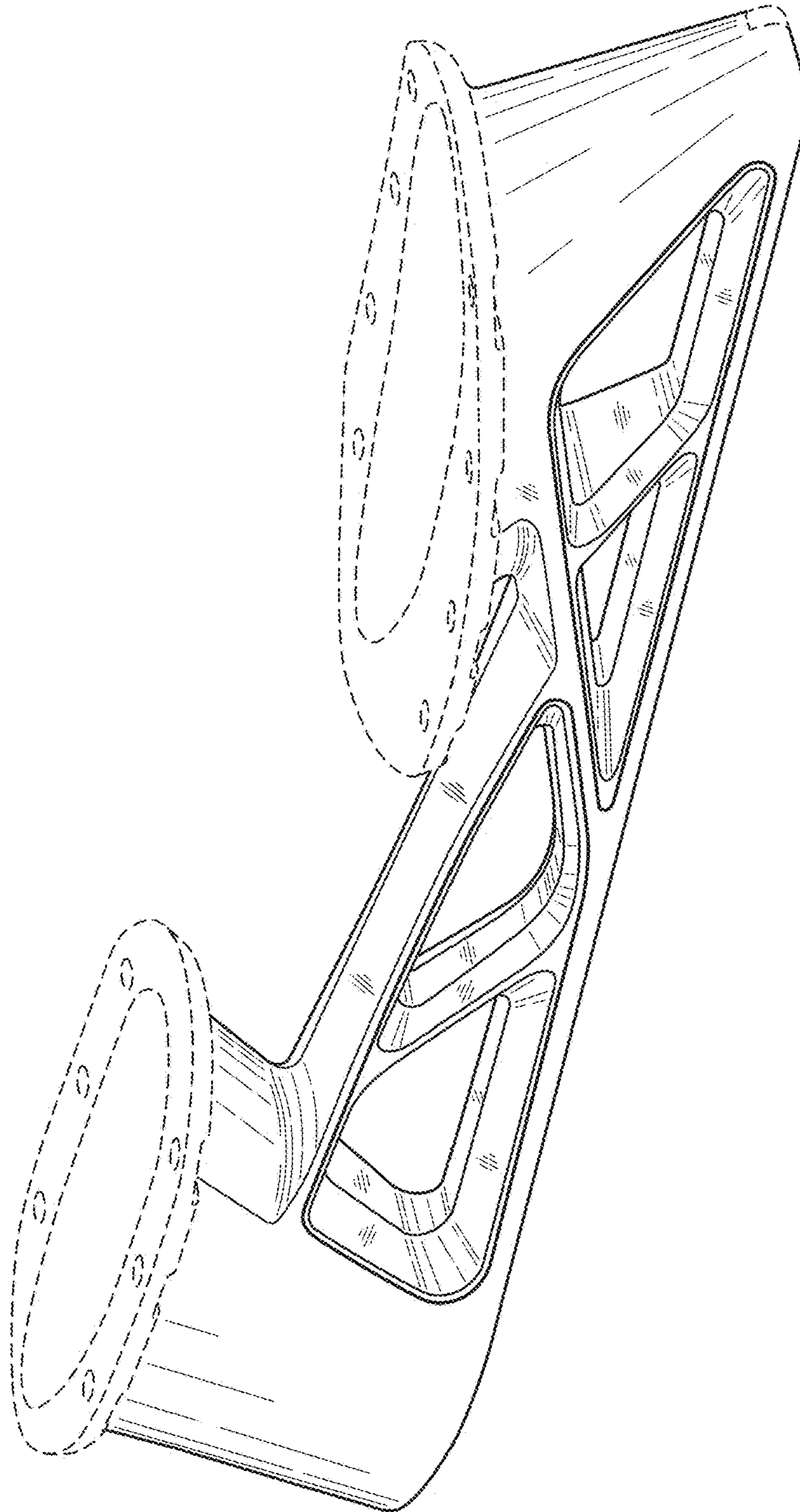

FIG. 7

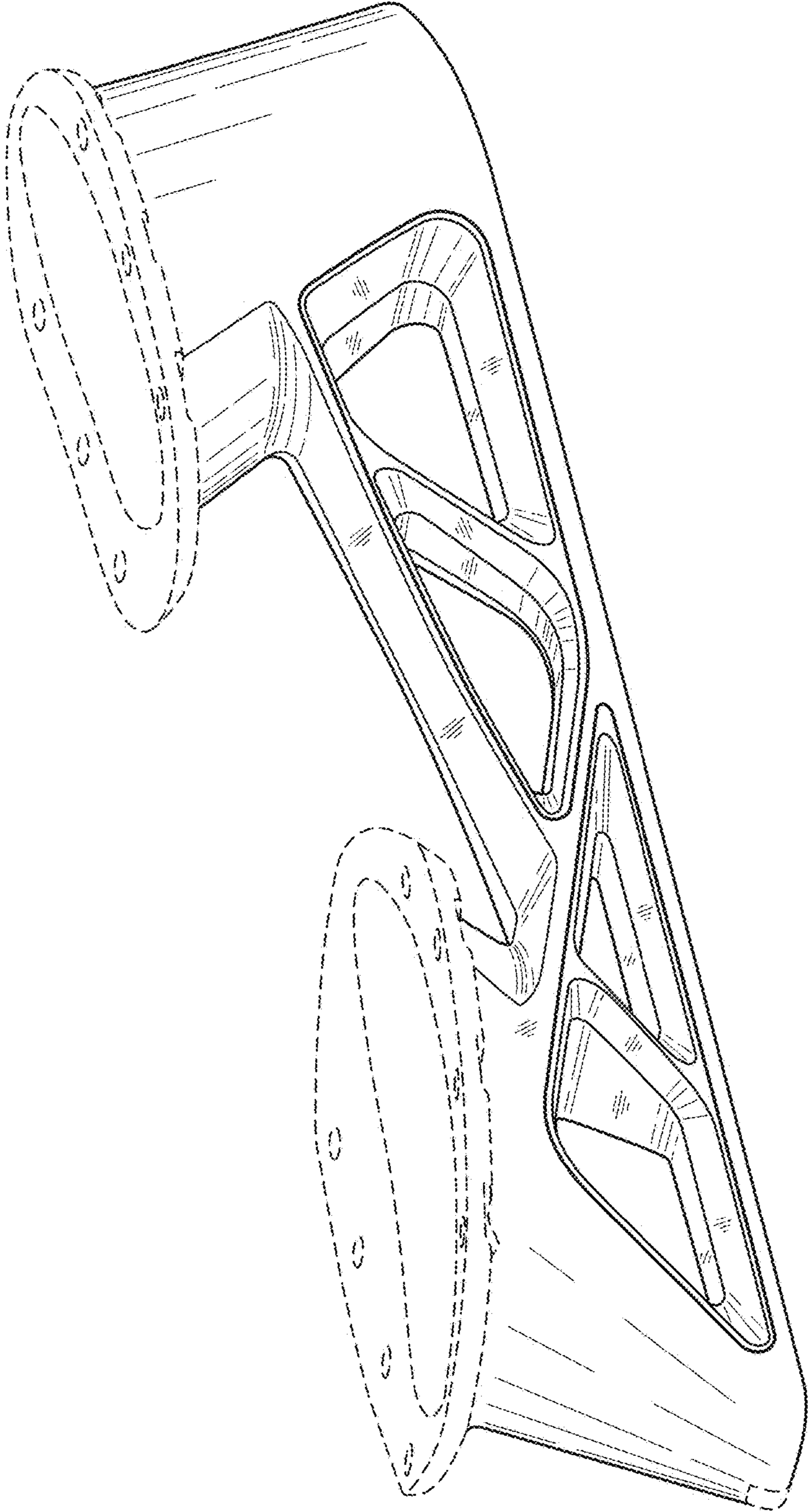

FIG. 8



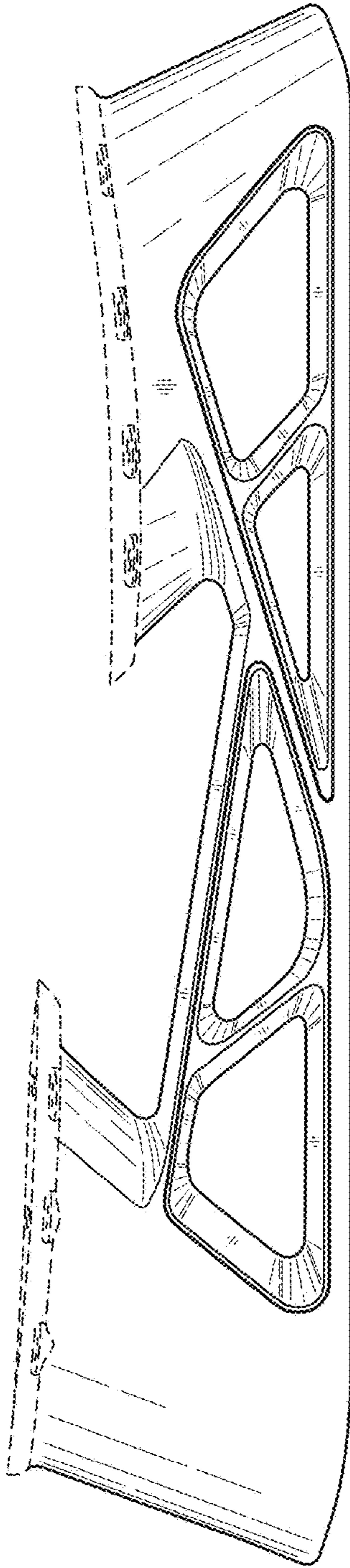

FIG. 9

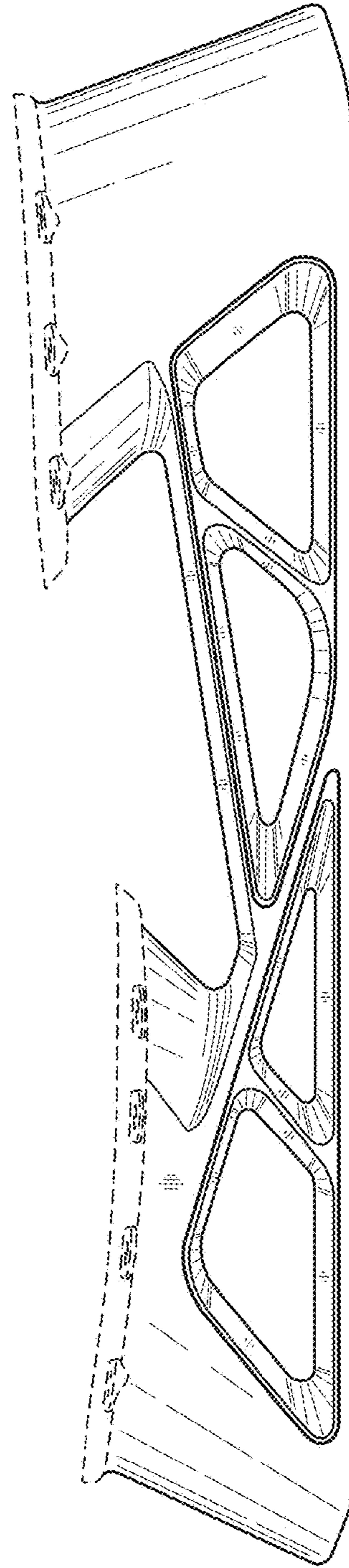

FIG. 10

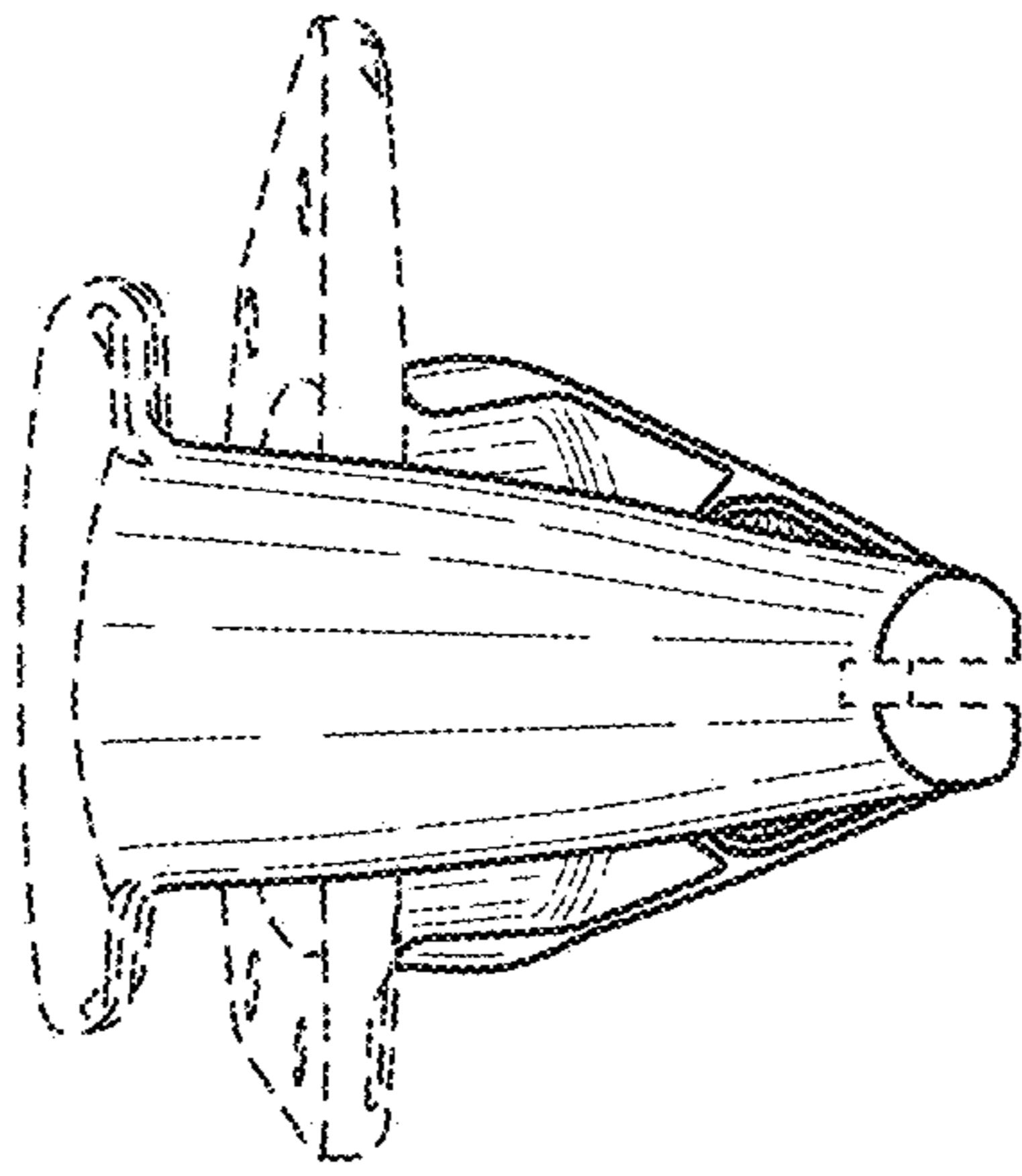

FIG. 11

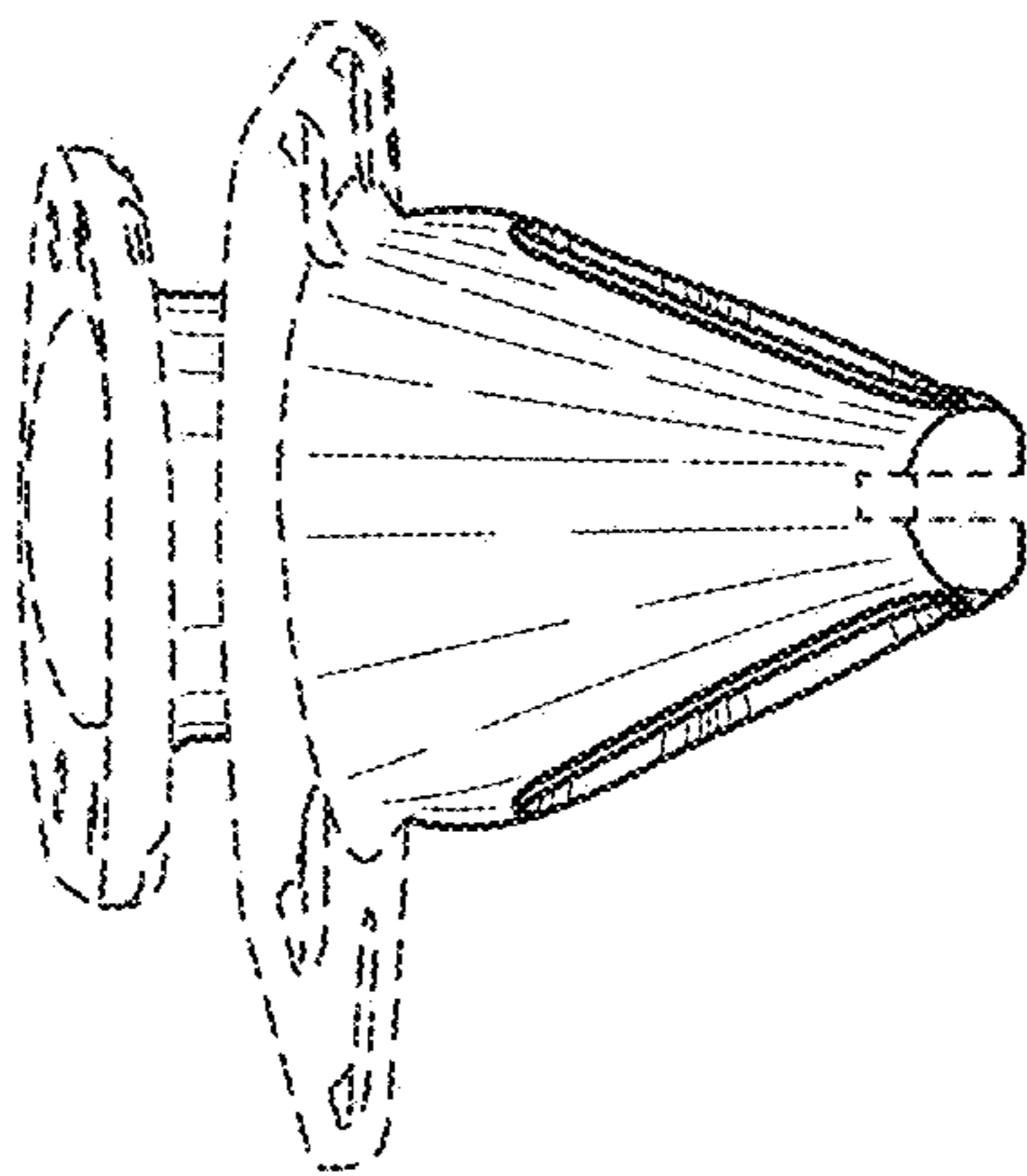

FIG. 12