



US00D836170S

(12) **United States Design Patent**
Tompkin

(10) **Patent No.:** **US D836,170 S**

(45) **Date of Patent:** **** Dec. 18, 2018**

(54) **ROBOT DRAGON**
(71) Applicant: **MerchSource, LLC**, Irvine, CA (US)
(72) Inventor: **Crispian Tompkin**, Los Angeles, CA (US)
(73) Assignee: **MerchSource, LLC**, Irvine, CA (US)
(**) Term: **15 Years**

D479,862 S * 9/2003 Takahashi D21/578
D663,791 S * 7/2012 Wong D21/578
D663,792 S * 7/2012 Wong D21/578
8,483,873 B2 * 7/2013 Wong G06N 3/008
700/245
D747,777 S * 1/2016 Greenly D21/578
D762,271 S * 7/2016 Chow D21/578
D785,099 S * 4/2017 Morales D21/578
D785,724 S * 5/2017 Morales D21/578
D798,967 S * 10/2017 Tompkin A63H 7/00
D21/615

(21) Appl. No.: **29/608,933**
(22) Filed: **Jun. 27, 2017**
(51) **LOC (11) Cl.** **21-01**
(52) **U.S. Cl.**
USPC **D21/615**; D21/578
(58) **Field of Classification Search**
USPC D6/598; D11/158, 159, 162;
D21/576–595, 615; 446/73, 97, 368–369,
446/376; 180/8.6; D30/160
CPC ... A63H 3/00; A63H 3/02; A63H 3/04; A63H
3/16; A63H 3/20; A63H 33/00; A63H
7/00; A63H 11/00
See application file for complete search history.

* cited by examiner

Primary Examiner — Sandra L Morris
(74) *Attorney, Agent, or Firm* — Avyno Law P.C.

(57) **CLAIM**

I claim the ornamental design for a robot dragon, as shown and described.

DESCRIPTION

FIG. 1 is a front perspective view of a robot dragon.
FIG. 2 is a side view of the right side of the robot dragon of FIG. 1.
FIG. 3 is a side view of the left side of the robot dragon of FIG. 1.
FIG. 4 is a top view of the robot dragon of FIG. 1.
FIG. 5 is a bottom view of the robot dragon of FIG. 1.
FIG. 6 is a rear view of the robot dragon of FIG. 1; and
FIG. 7 is a front view of the robot dragon of FIG. 1.
The dashed lines in various figures are for illustrative purposes only and form no part of the claimed design.

(56) **References Cited**
U.S. PATENT DOCUMENTS
5,306,199 A * 4/1994 Locricchio A63H 7/00
446/177
D478,362 S * 8/2003 Nakase D21/578

1 Claim, 6 Drawing Sheets

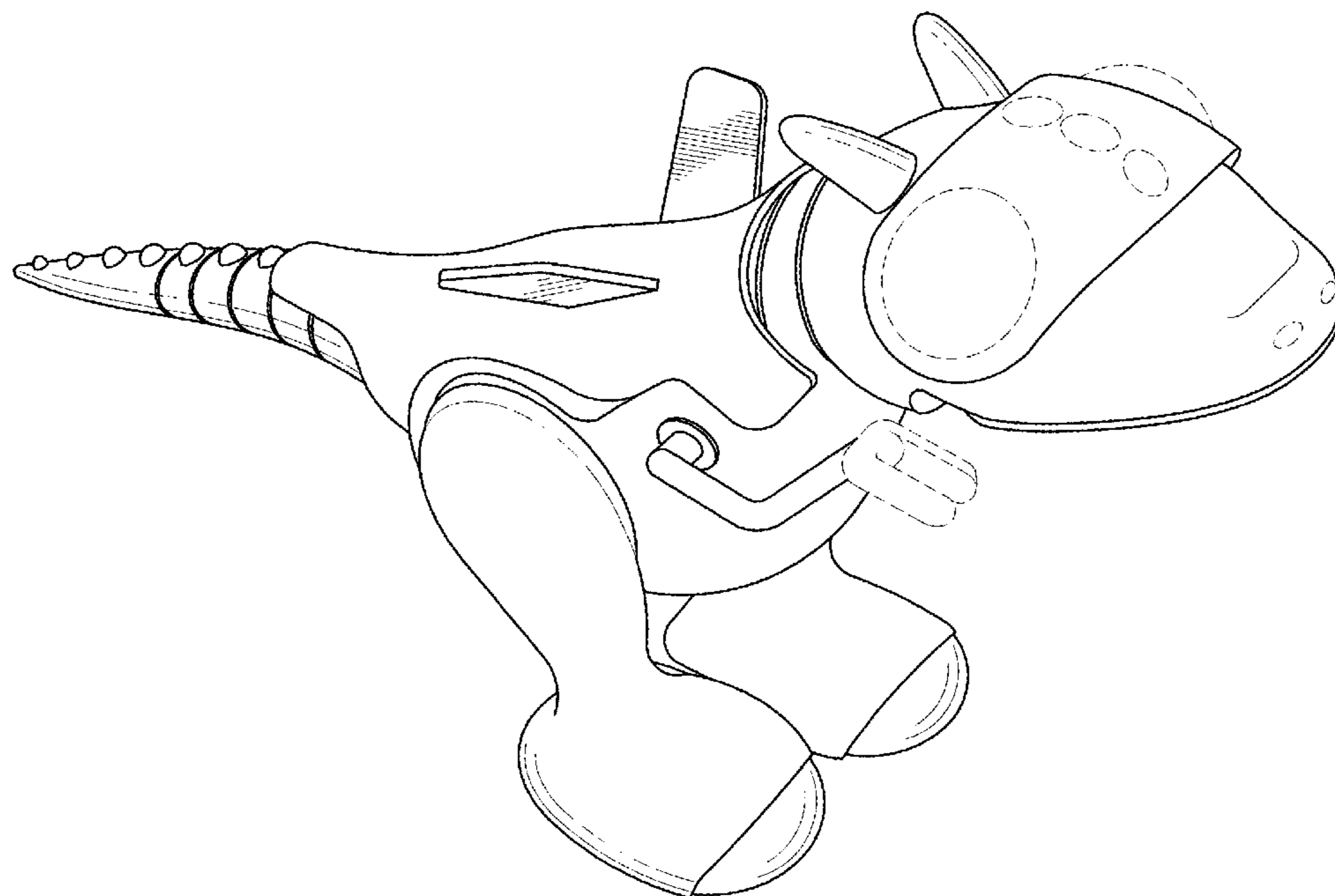

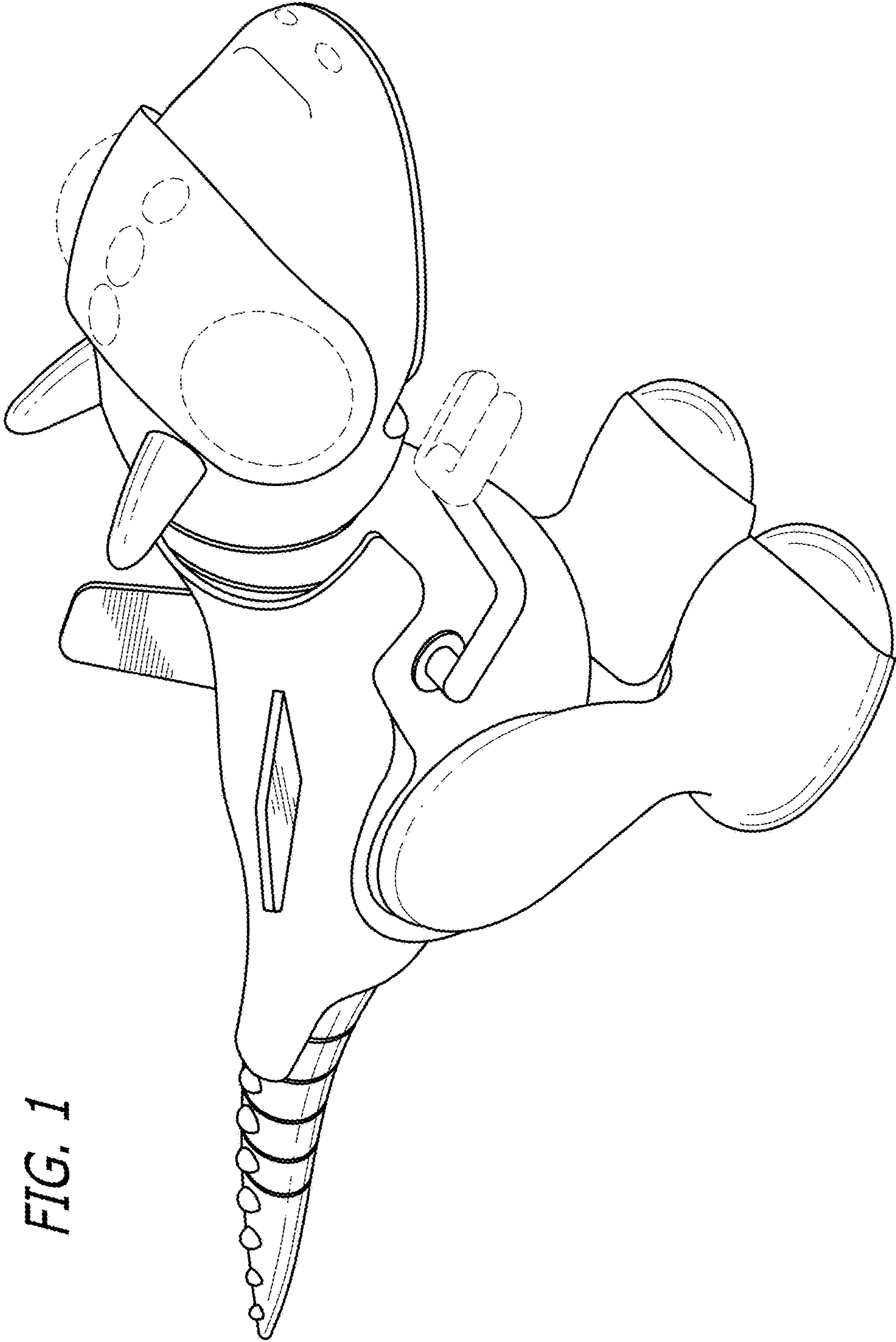

FIG. 1

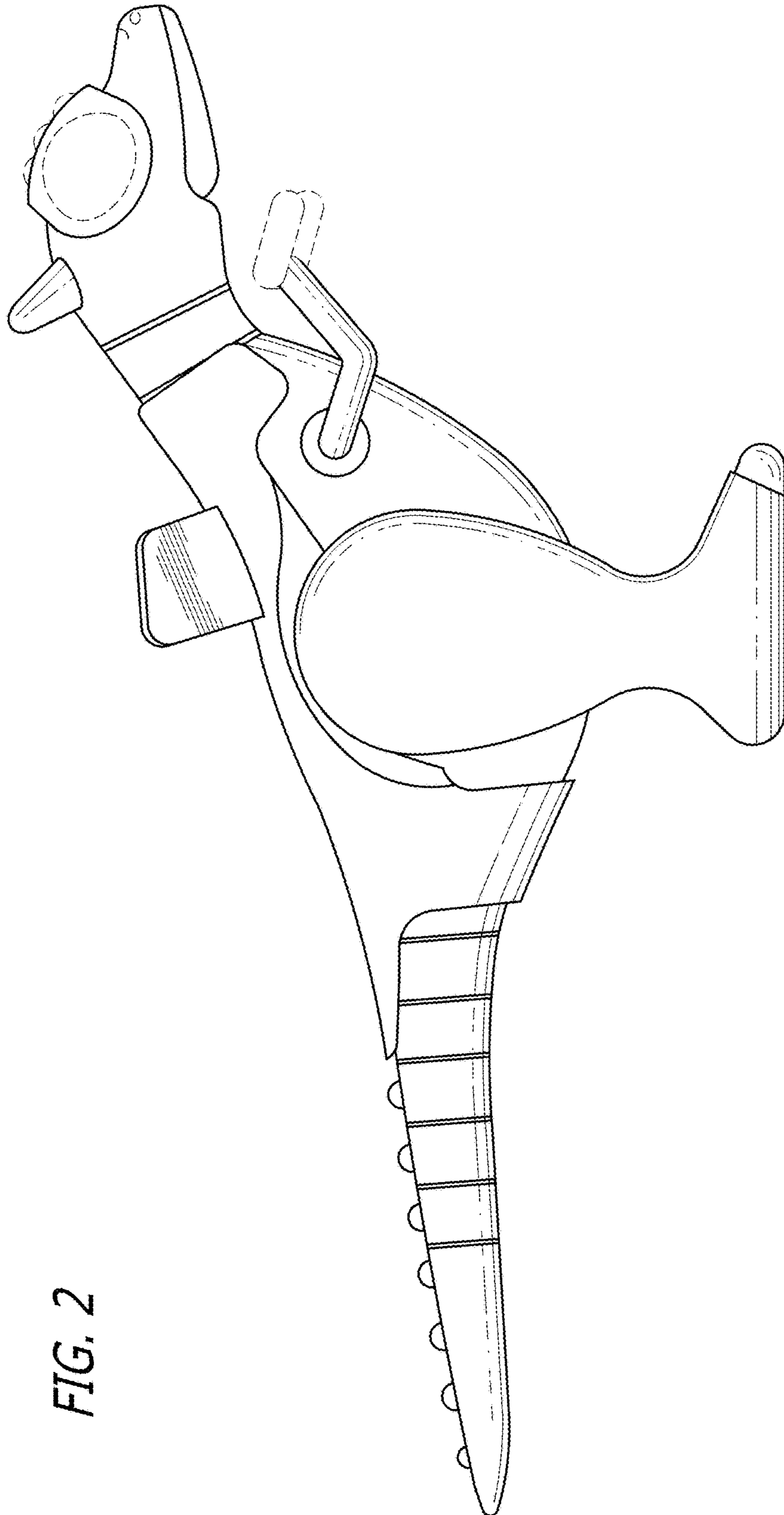
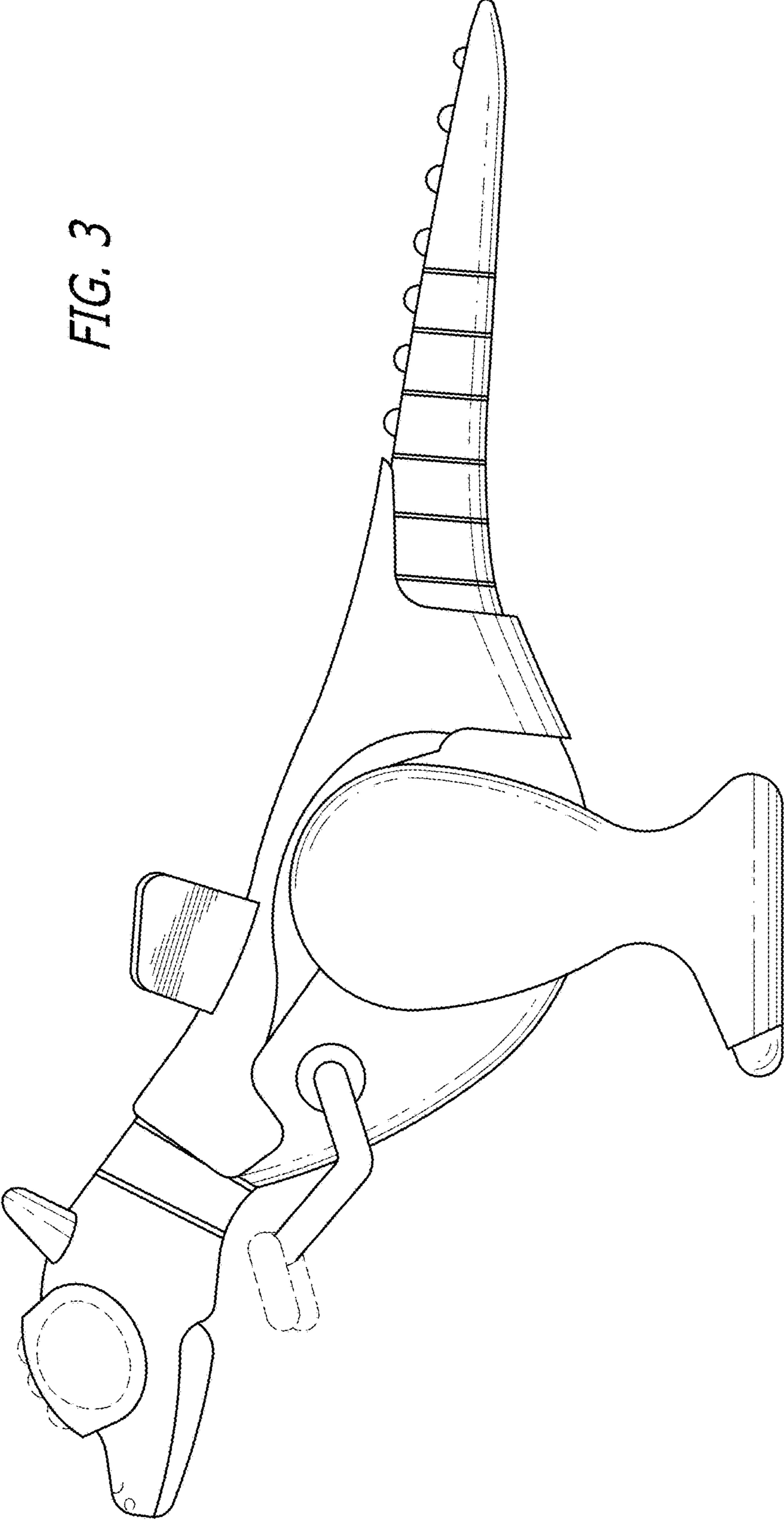

FIG. 2

FIG. 3



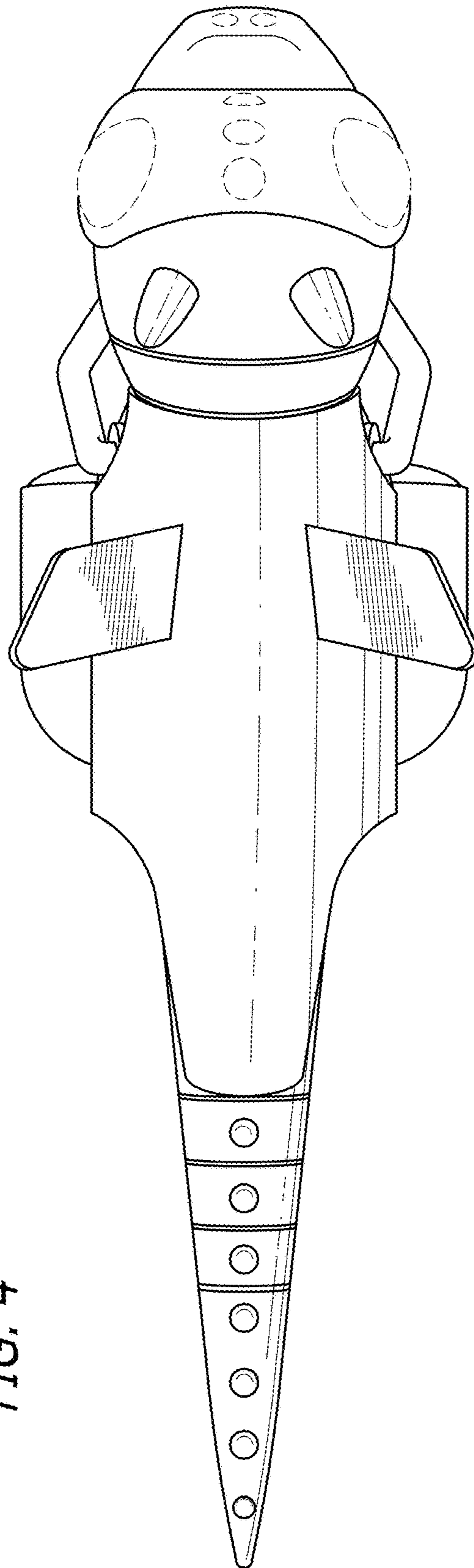

FIG. 4

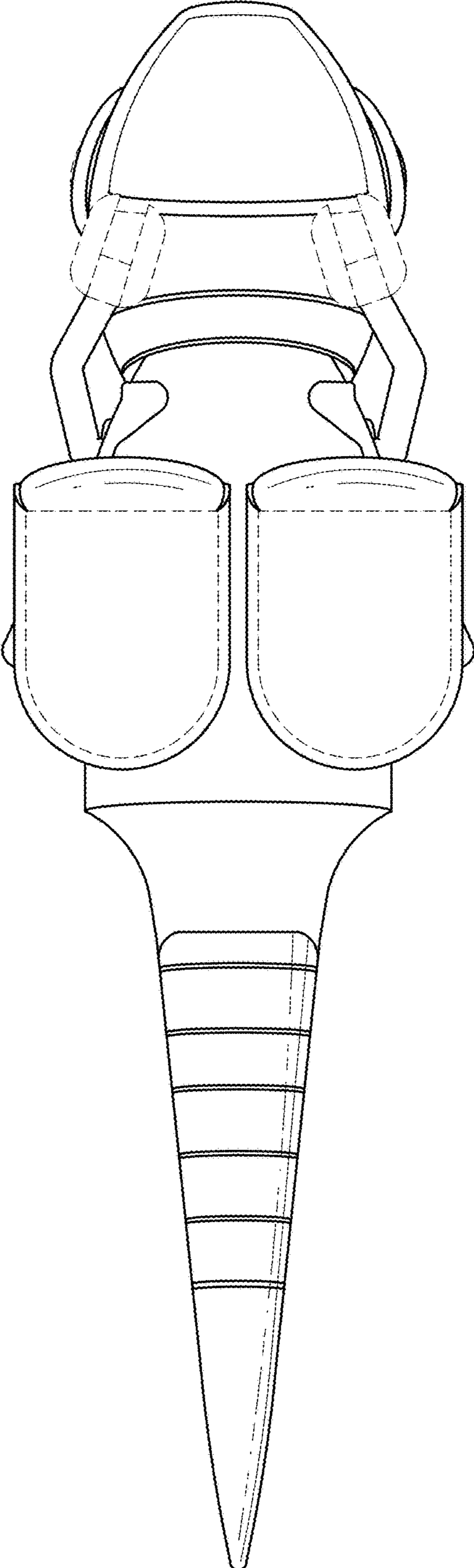

FIG. 5

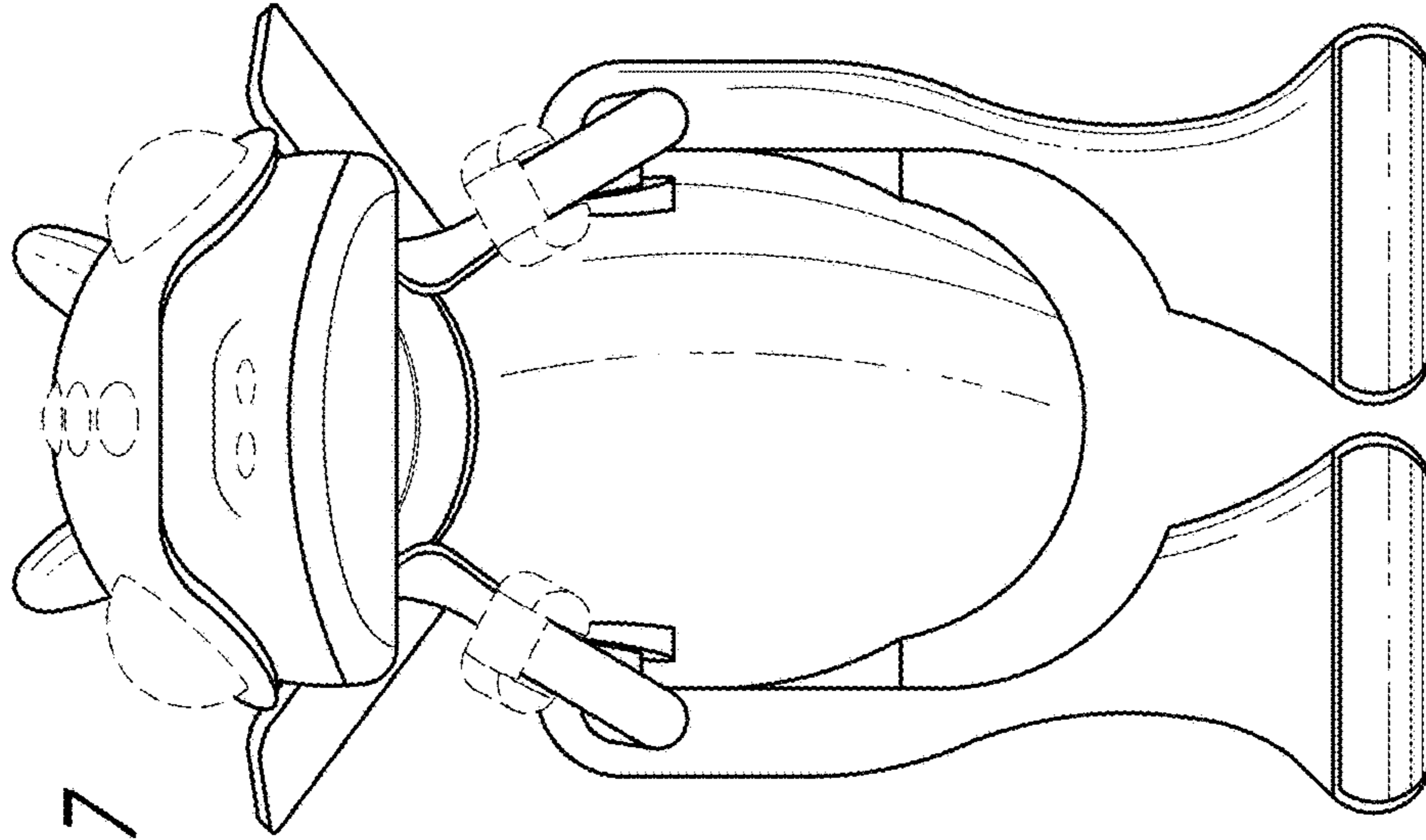

FIG. 7

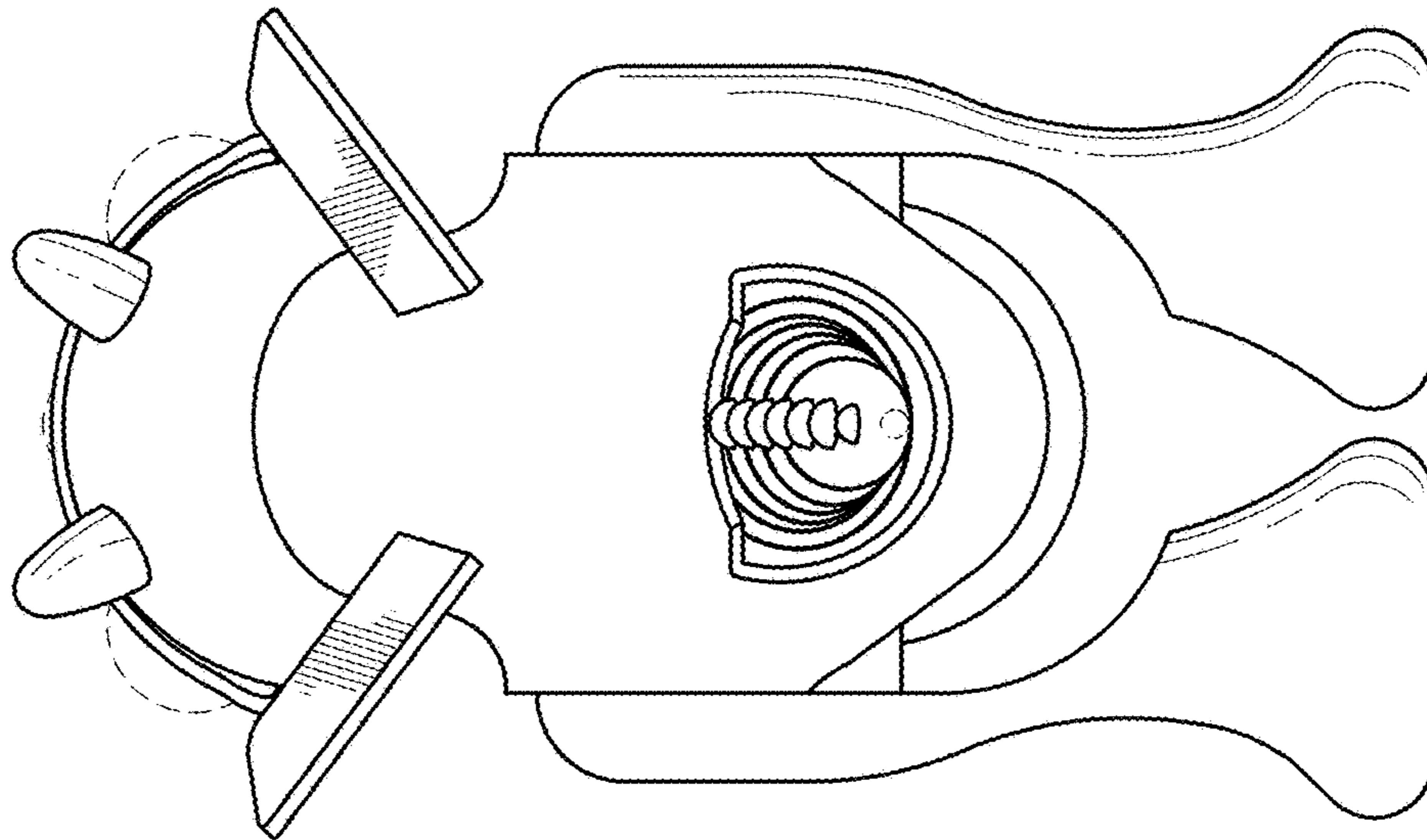

FIG. 6