



US00D836169S

(12) **United States Design Patent**
Sapulich

(10) **Patent No.:** **US D836,169 S**

(45) **Date of Patent:** **** Dec. 18, 2018**

(54) **FISH PLUSH TOY**

(71) Applicant: **TOMY International, Inc.**, Dyersville, IA (US)

(72) Inventor: **Joseph Sapulich**, Dyersville, IA (US)

(73) Assignee: **TOMY International, Inc.**, Dyersville, IA (US)

(**) Term: **15 Years**

(21) Appl. No.: **29/617,287**

(22) Filed: **Sep. 13, 2017**

(51) **LOC (11) Cl.** **21-01**

(52) **U.S. Cl.**
USPC **D21/599**

(58) **Field of Classification Search**
USPC D6/598; D11/158, 162; D21/576-595, D21/597-599; 446/368-369, 376, 428, 446/487; 180/8.6; D30/160
CPC ... A63H 3/00; A63H 3/02; A63H 3/04; A63H 3/16; A63H 3/28; A63H 33/00; A63H 7/06; A63H 11/00; A63H 11/10; A63H 11/20; A63H 13/00
See application file for complete search history.

(56) **References Cited**

U.S. PATENT DOCUMENTS

D188,685 S * 8/1960 Melaragno D11/158
D317,801 S * 6/1991 Tapdrup D21/599

D350,577 S * 9/1994 Giudice D21/599
D403,239 S * 12/1998 Ying D21/597
6,126,510 A * 10/2000 Weiss, Jr. A63H 3/02
446/226
D527,678 S * 9/2006 Warner D11/158
D536,141 S * 1/2007 Renforth A63H 3/02
D30/160
D536,489 S * 2/2007 Renforth D30/160
D638,081 S * 5/2011 Julien D21/599
D716,381 S * 10/2014 Lo D21/599
D793,492 S * 8/2017 Zanger D21/597

* cited by examiner

Primary Examiner — Sandra L Morris

(74) *Attorney, Agent, or Firm* — Saul Ewing Arnstein & Lehr LLP

(57) **CLAIM**

The ornamental design for a fish plush toy, as shown and described.

DESCRIPTION

FIG. 1 is a perspective view of a fish plush toy, the features depicted in broken lines form no part of the claimed design; FIG. 2 is a front view of the embodiment of FIG. 1; FIG. 3 is a rear view of the embodiment of FIG. 1; FIG. 4 is a right side view of the embodiment of FIG. 1; FIG. 5 is a left side view of the embodiment of FIG. 1; FIG. 6 is a bottom view of the embodiment of FIG. 1; and, FIG. 7 is a top view of the embodiment of FIG. 1.

1 Claim, 4 Drawing Sheets

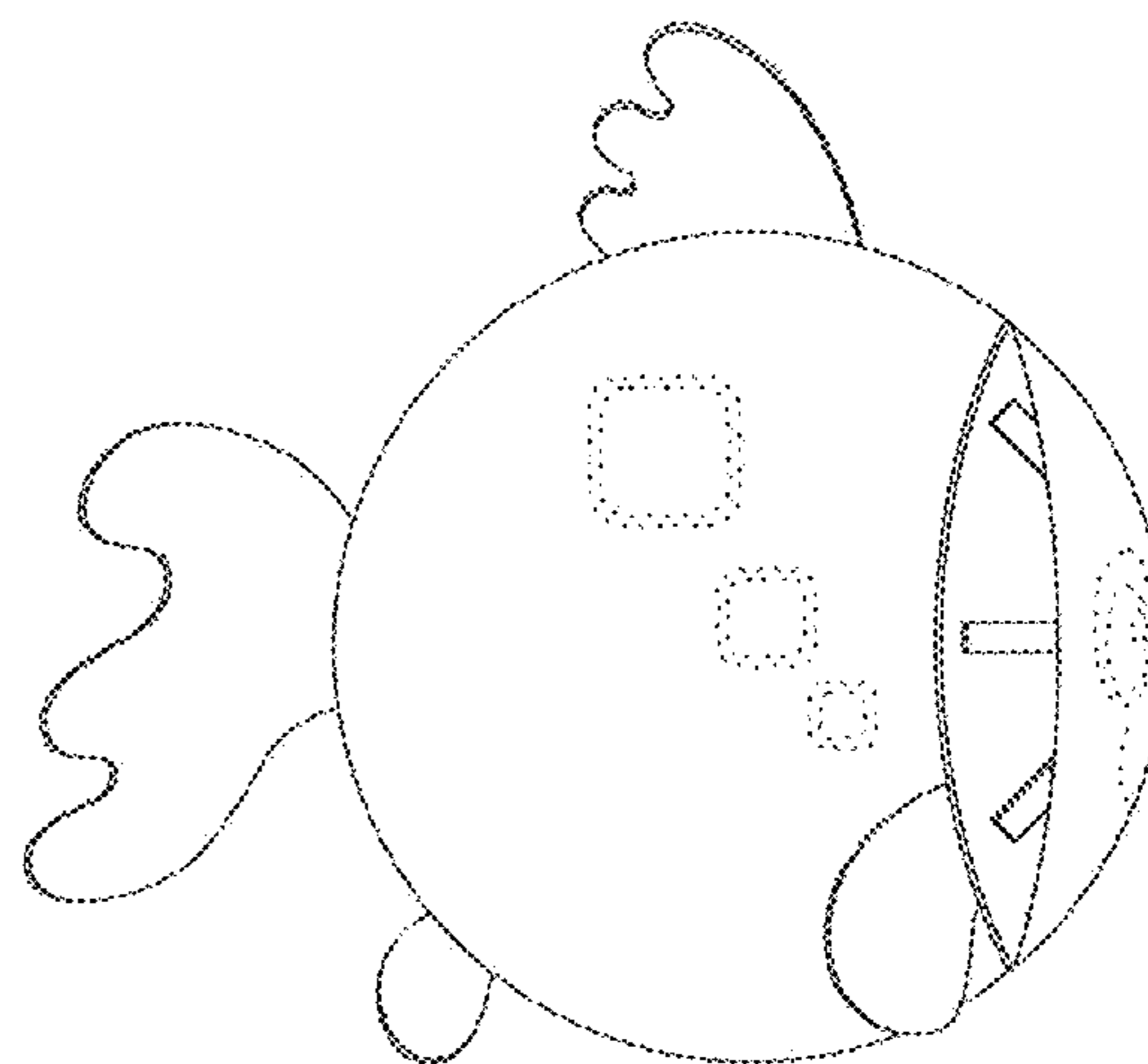
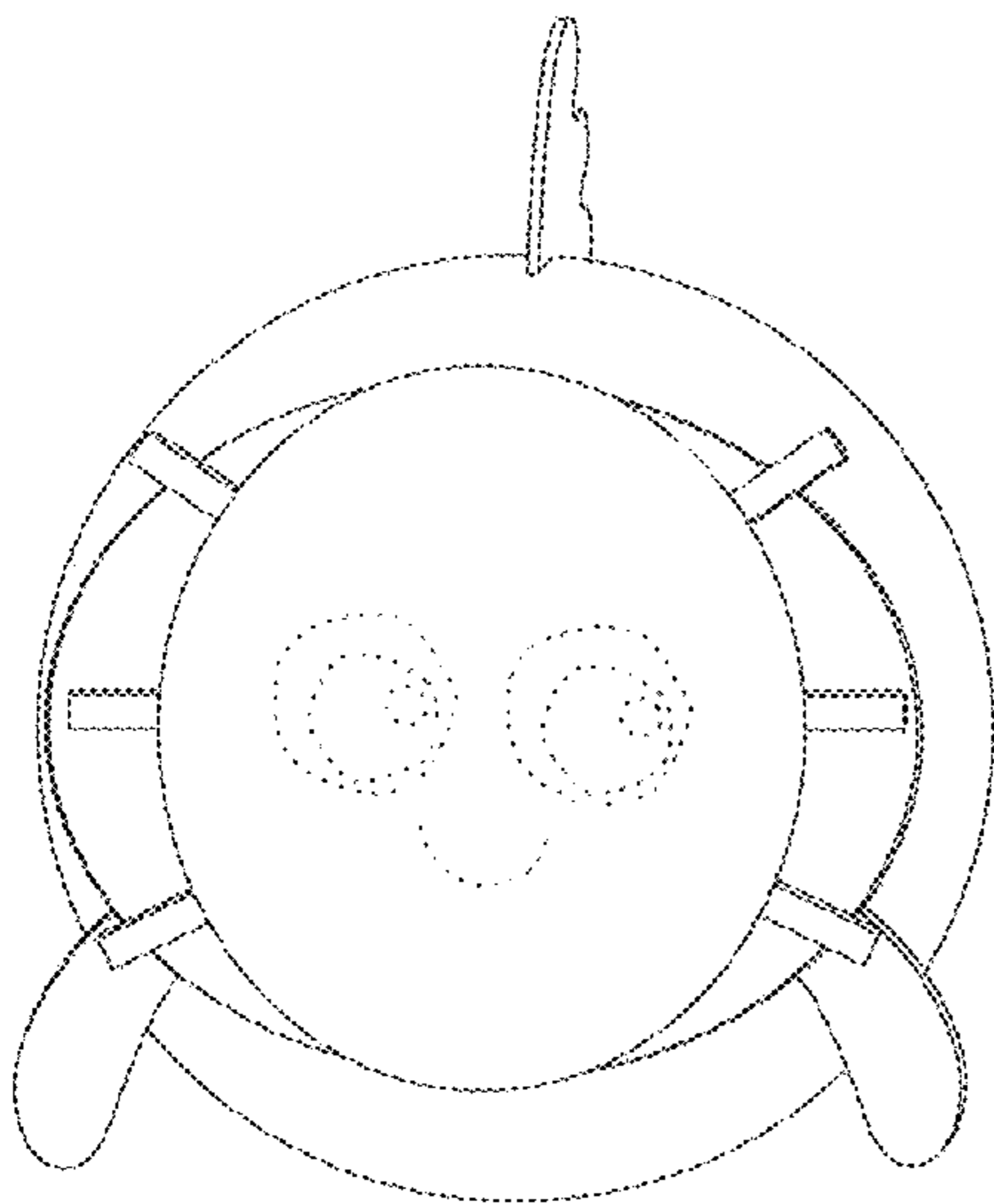

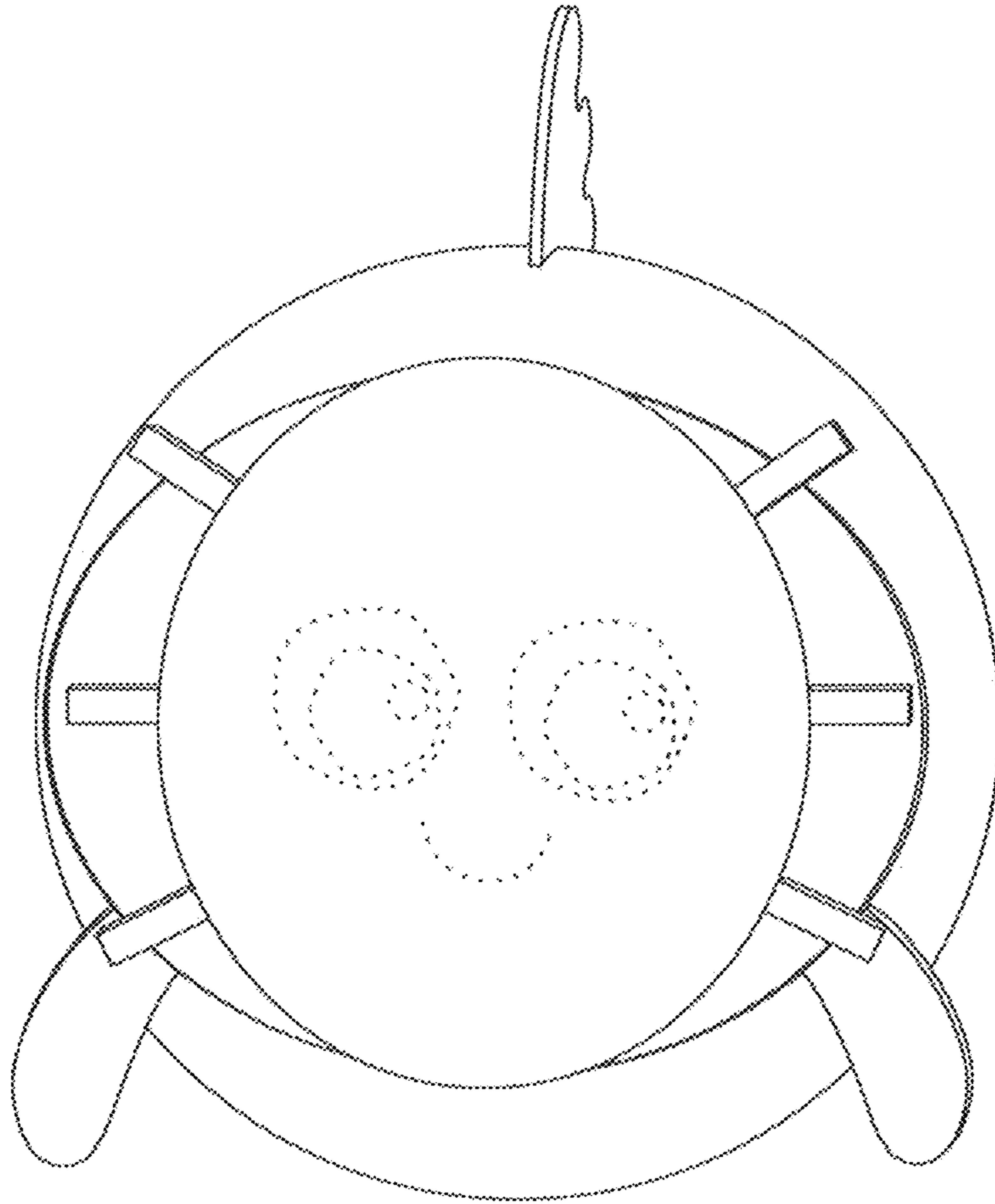

FIG. 1

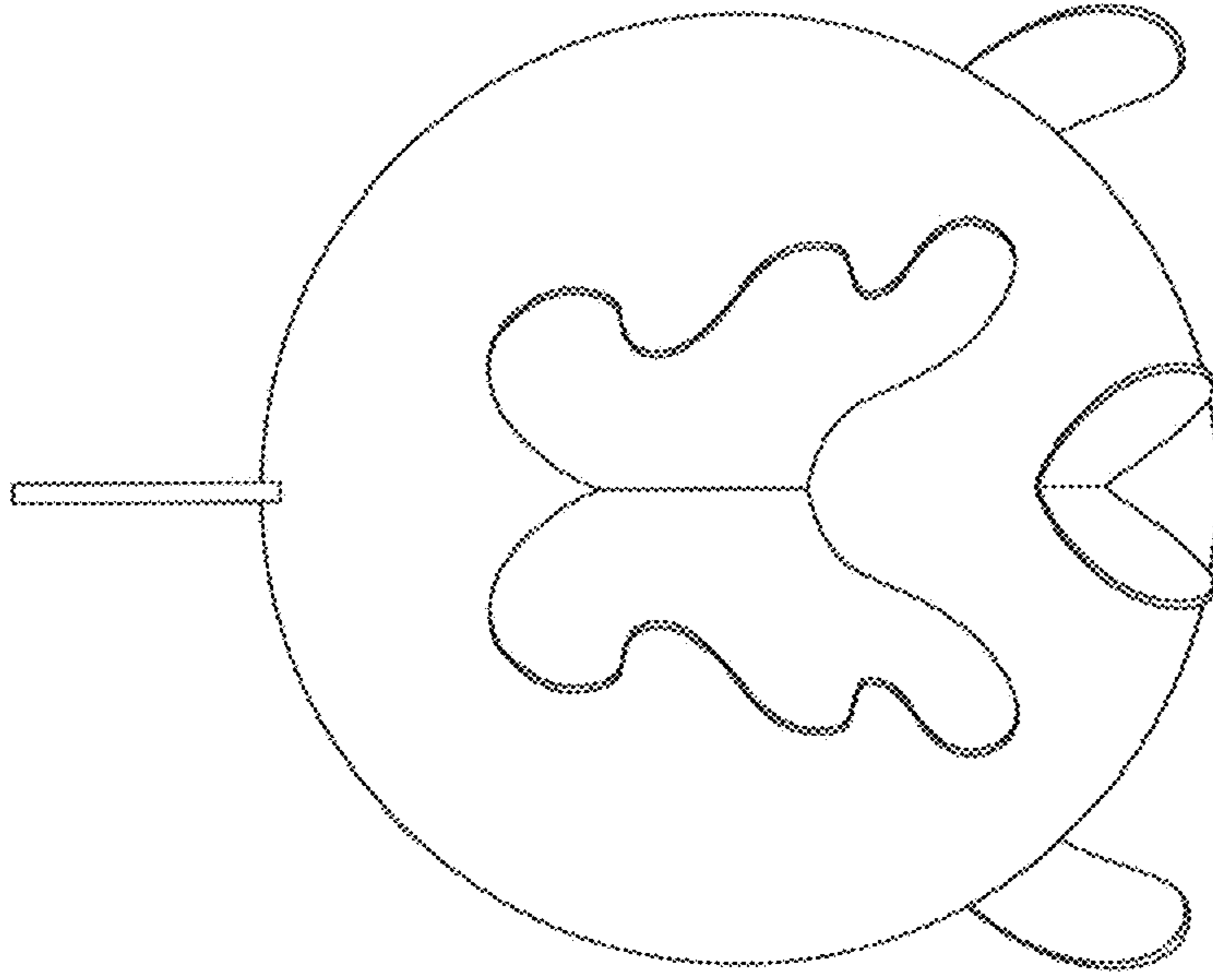

FIG. 3

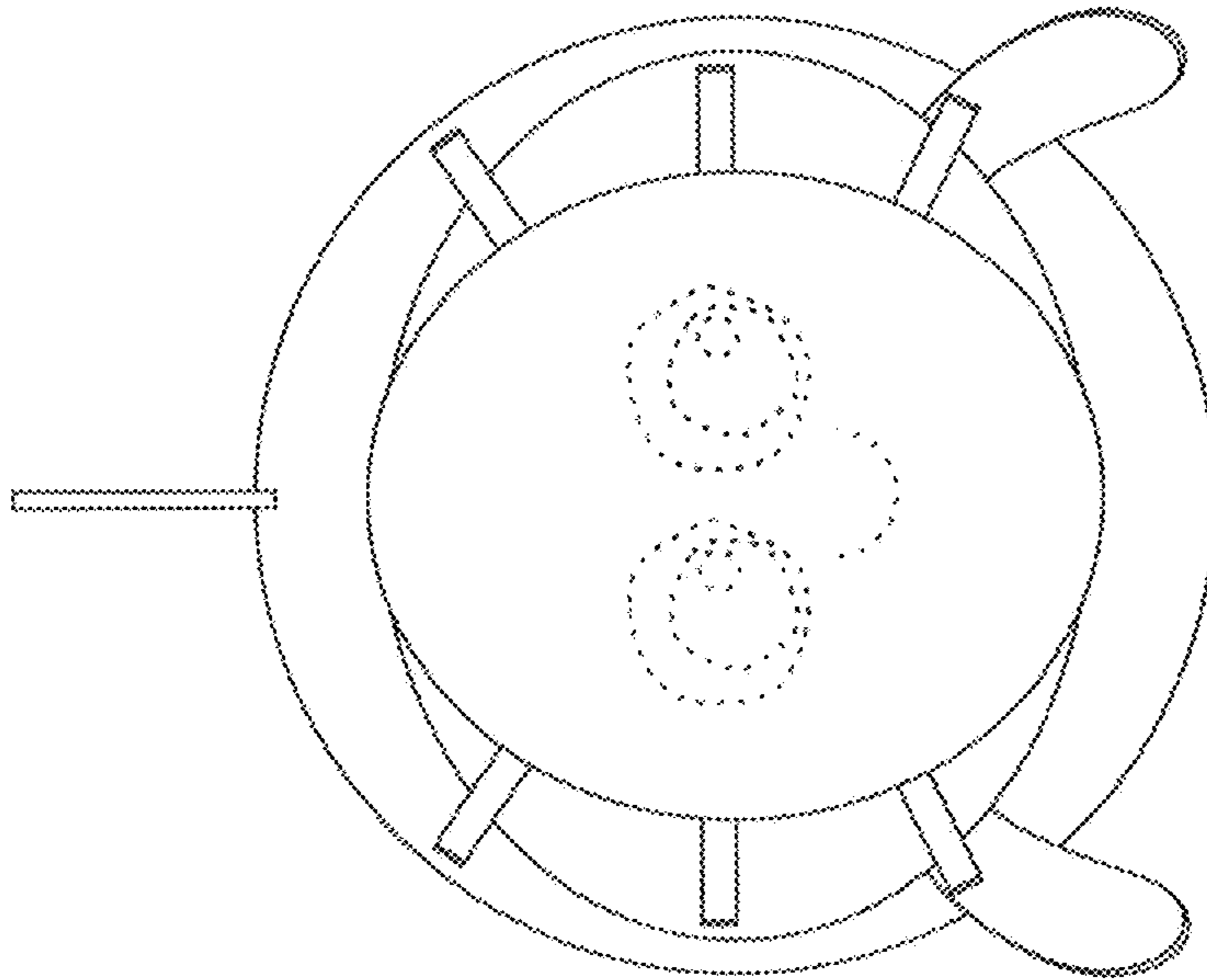

FIG. 2

FIG. 4

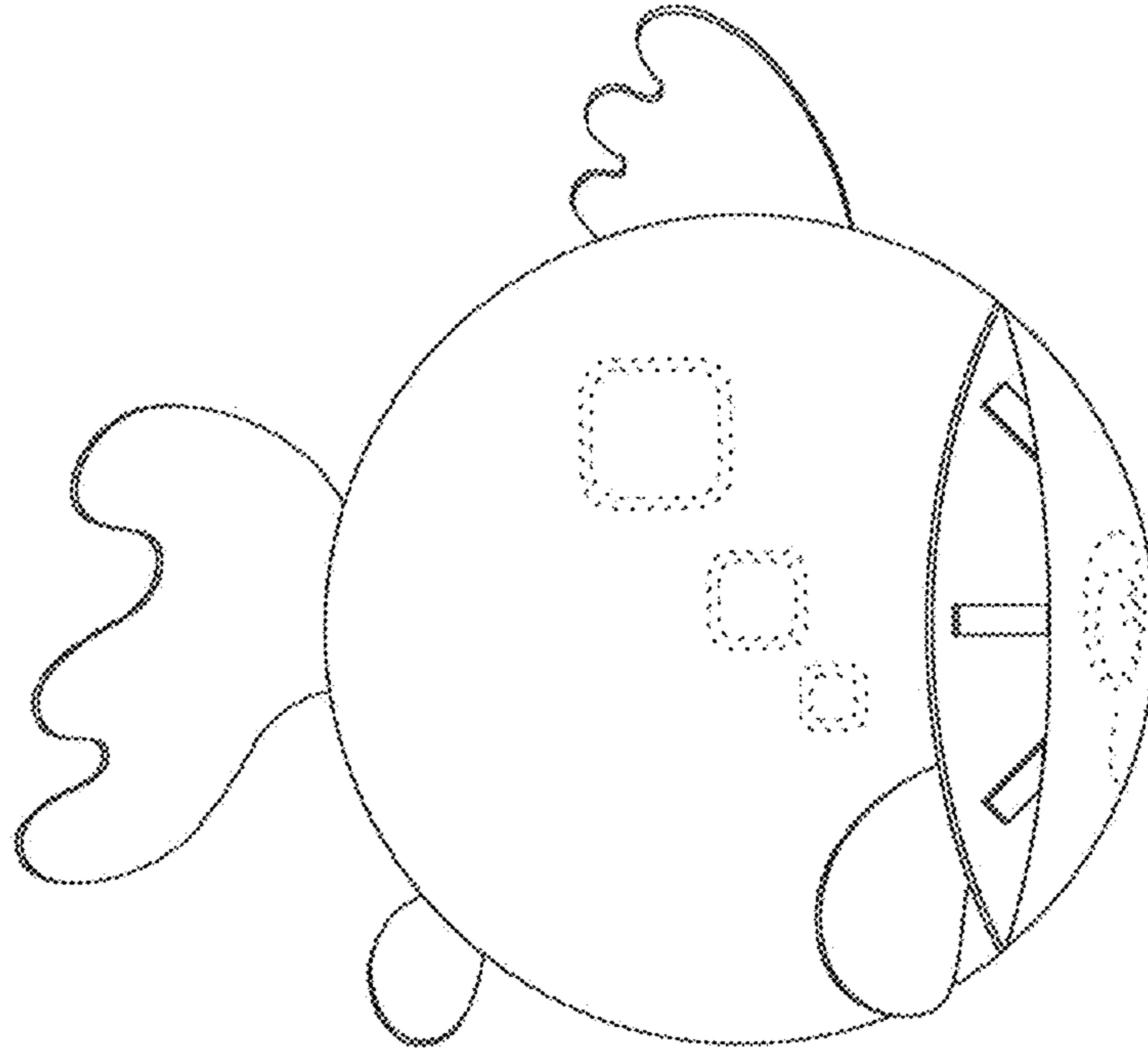
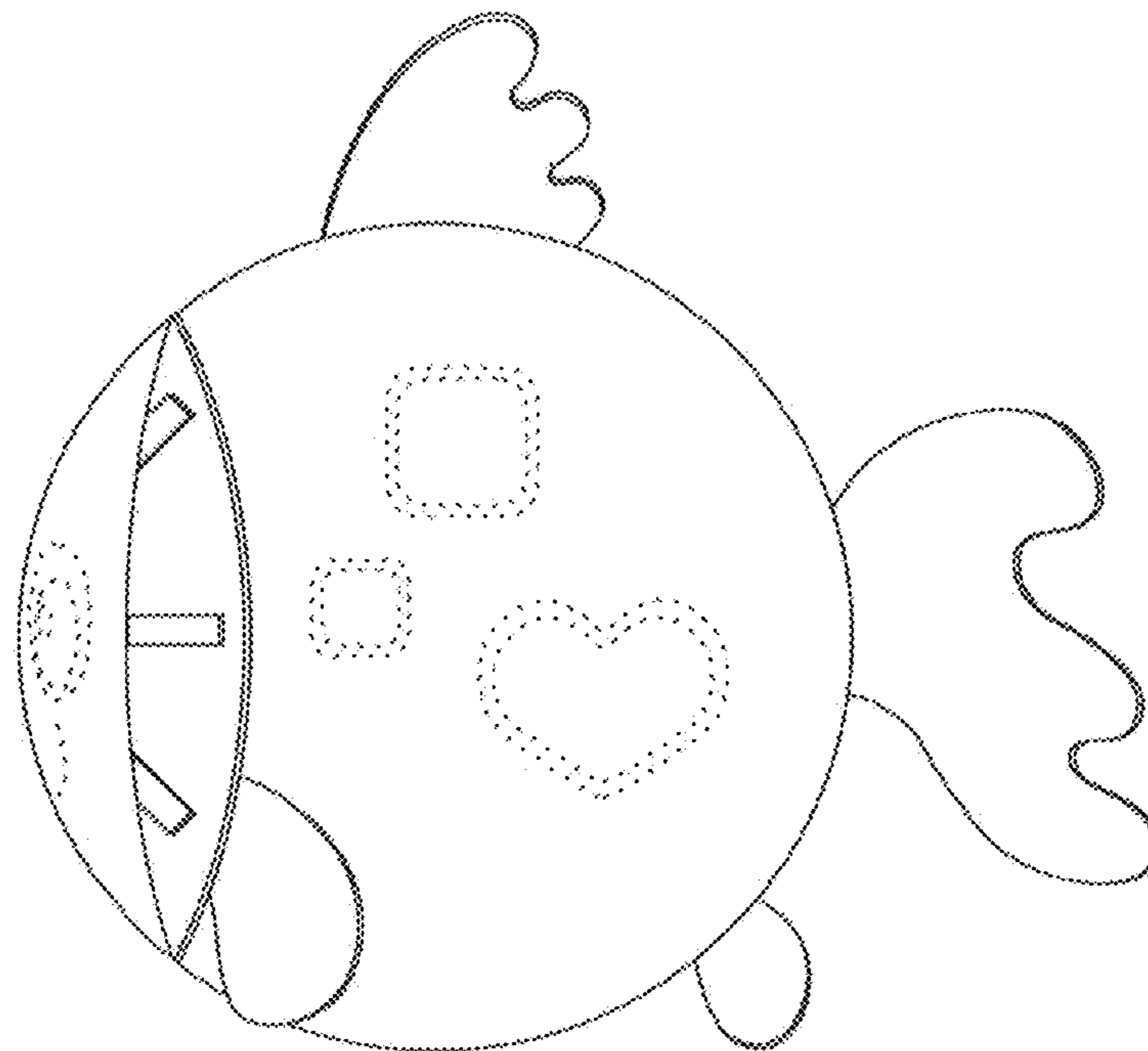

FIG. 5



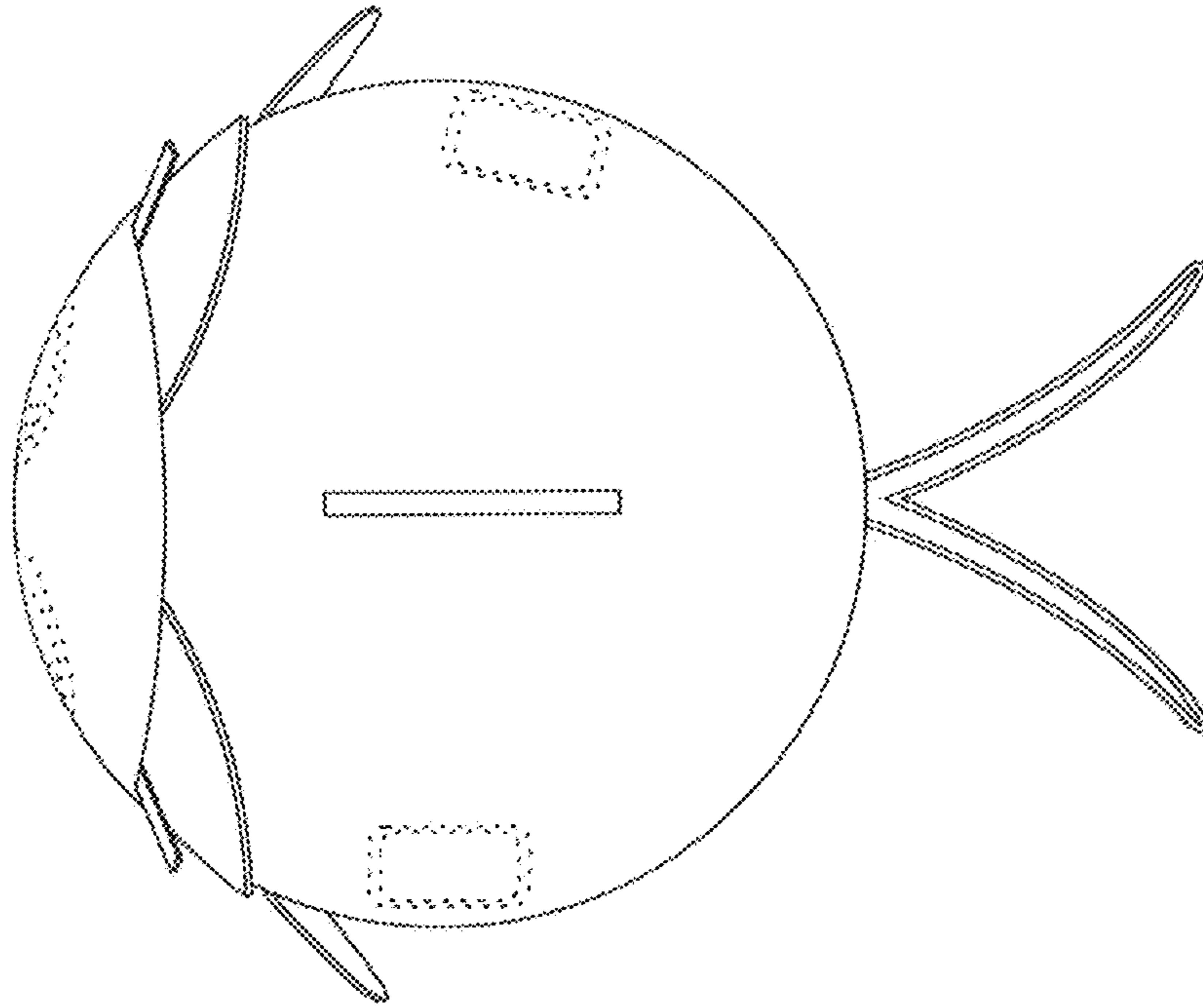

FIG. 7

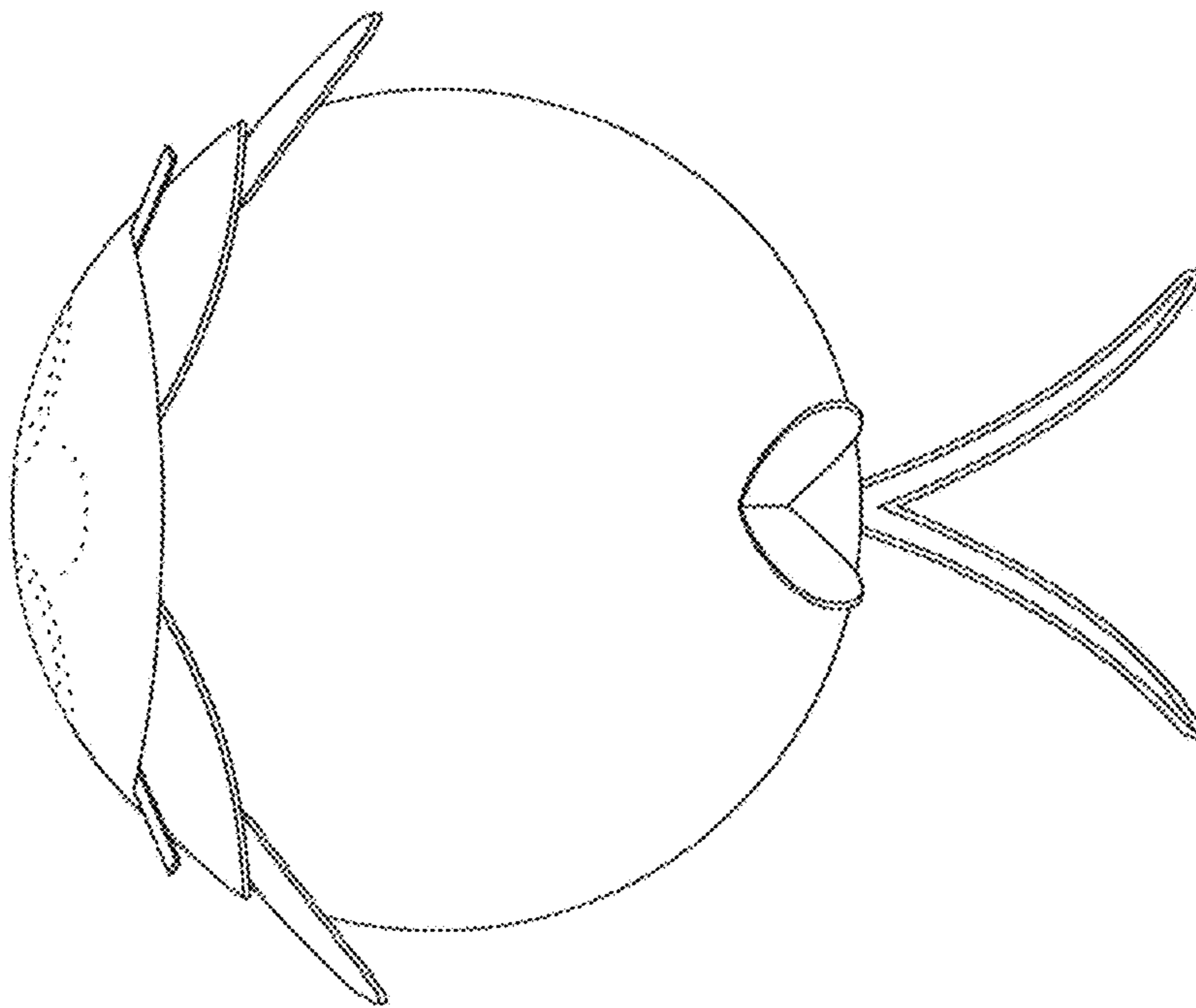

FIG. 6