



US00D836163S

(12) **United States Design Patent** (10) **Patent No.:** **US D836,163 S**  
**Jones** (45) **Date of Patent:** **\*\* Dec. 18, 2018**

(54) **BANNER ASSEMBLY**

(71) Applicant: **Craig Jones**, Merthyr Tydfil (GB)

(72) Inventor: **Craig Jones**, Merthyr Tydfil (GB)

(\*\*) Term: **15 Years**

(21) Appl. No.: **29/545,338**

(22) Filed: **Nov. 12, 2015**

(30) **Foreign Application Priority Data**

May 12, 2015 (EM) ..... 002698837

(51) **LOC (11) Cl.** ..... **20-03**

(52) **U.S. Cl.**  
USPC ..... **D20/10**

(58) **Field of Classification Search**  
USPC ..... D20/10, 17-19, 21, 41, 42, 99;  
D10/113.4

CPC ... G09F 7/00; G09F 9/00; G09F 9/301; G09F  
11/00; G09F 11/08; G09F 11/21; G09F  
11/29; G09F 11/30; G09F 11/325; G09F  
2011/0009; G09F 13/00; G09F 15/00;  
G09F 15/0025; G09F 15/0056; G09F  
15/0068; G09F 15/0087; G09B 29/06

See application file for complete search history.

(56) **References Cited**

**U.S. PATENT DOCUMENTS**

- 971,319 A \* 9/1910 Sheppard ..... G09B 29/06  
40/517
- 1,284,828 A \* 11/1918 Walby ..... G09F 11/29  
40/514
- D339,168 S \* 9/1993 Gerhart ..... D20/21
- 7,636,085 B2 \* 12/2009 Yang ..... H04M 1/0268  
345/107
- 8,904,683 B2 \* 12/2014 Tornqvist ..... E06B 9/40  
40/498
- 9,111,470 B2 \* 8/2015 Anderson ..... G09F 9/301

- 9,747,822 B2 \* 8/2017 Lee ..... G09F 15/0056
- 2009/0158627 A1 \* 6/2009 Lee ..... G09F 11/08  
40/515
- 2010/0055661 A1 \* 3/2010 Hegwood ..... A47B 97/02  
434/420
- 2010/0263245 A1 \* 10/2010 Bowser ..... G09F 11/21  
40/517
- 2013/0006188 A1 \* 1/2013 Pommereau ..... A61M 5/178  
604/189
- 2013/0118044 A1 \* 5/2013 Scaturro ..... G09F 11/21  
40/515

(Continued)

*Primary Examiner* — Mary Ann Calabrese

(74) *Attorney, Agent, or Firm* — King & Schickli, PLLC

(57) **CLAIM**

The ornamental design for a banner assembly, as shown and described.

**DESCRIPTION**

FIG. 1 is a bottom view of the banner assembly;  
 FIG. 2 is a front view of the banner assembly;  
 FIG. 3 is a left rear above view of the banner assembly;  
 FIG. 4 is a left rear below view of the banner assembly;  
 FIG. 5 is a left view of the banner assembly;  
 FIG. 6 is a rear view of the banner assembly;  
 FIG. 7 is a top view of the banner assembly;  
 FIG. 8 is a bottom view of the banner assembly in an alternate extended configuration of use;  
 FIG. 9 is a front view of the banner assembly in an alternate extended configuration of use;  
 FIG. 10 is a left rear of the banner assembly in an alternate extended configuration of use;  
 FIG. 11 is a rear view of the banner assembly in an alternate extended configuration of use; and,  
 FIG. 12 is a top view of the banner assembly in an alternate extended configuration of use.  
 The broken lines in the drawings depict portions of the banner assembly that form no part of the claimed design.

**1 Claim, 12 Drawing Sheets**

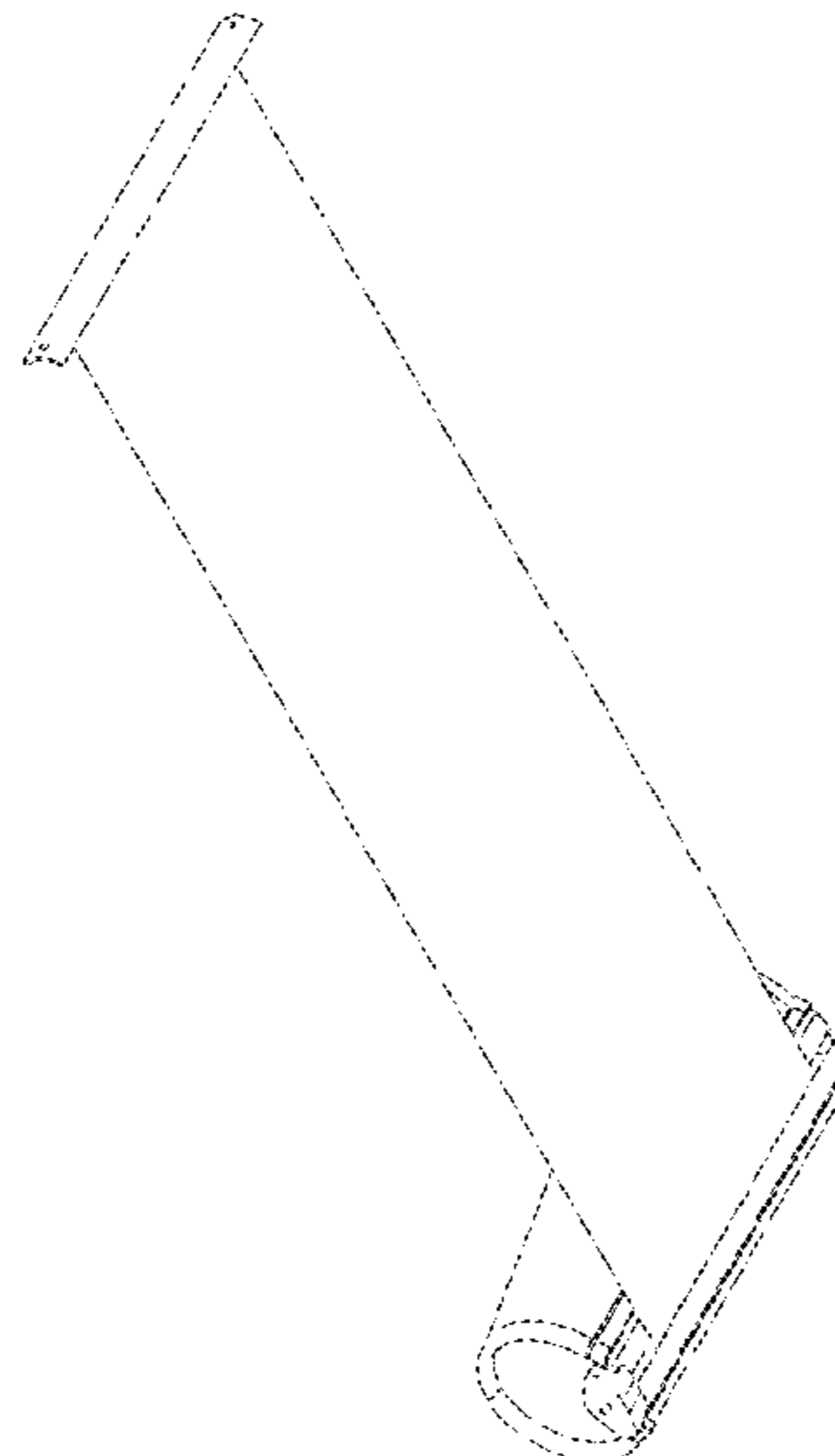
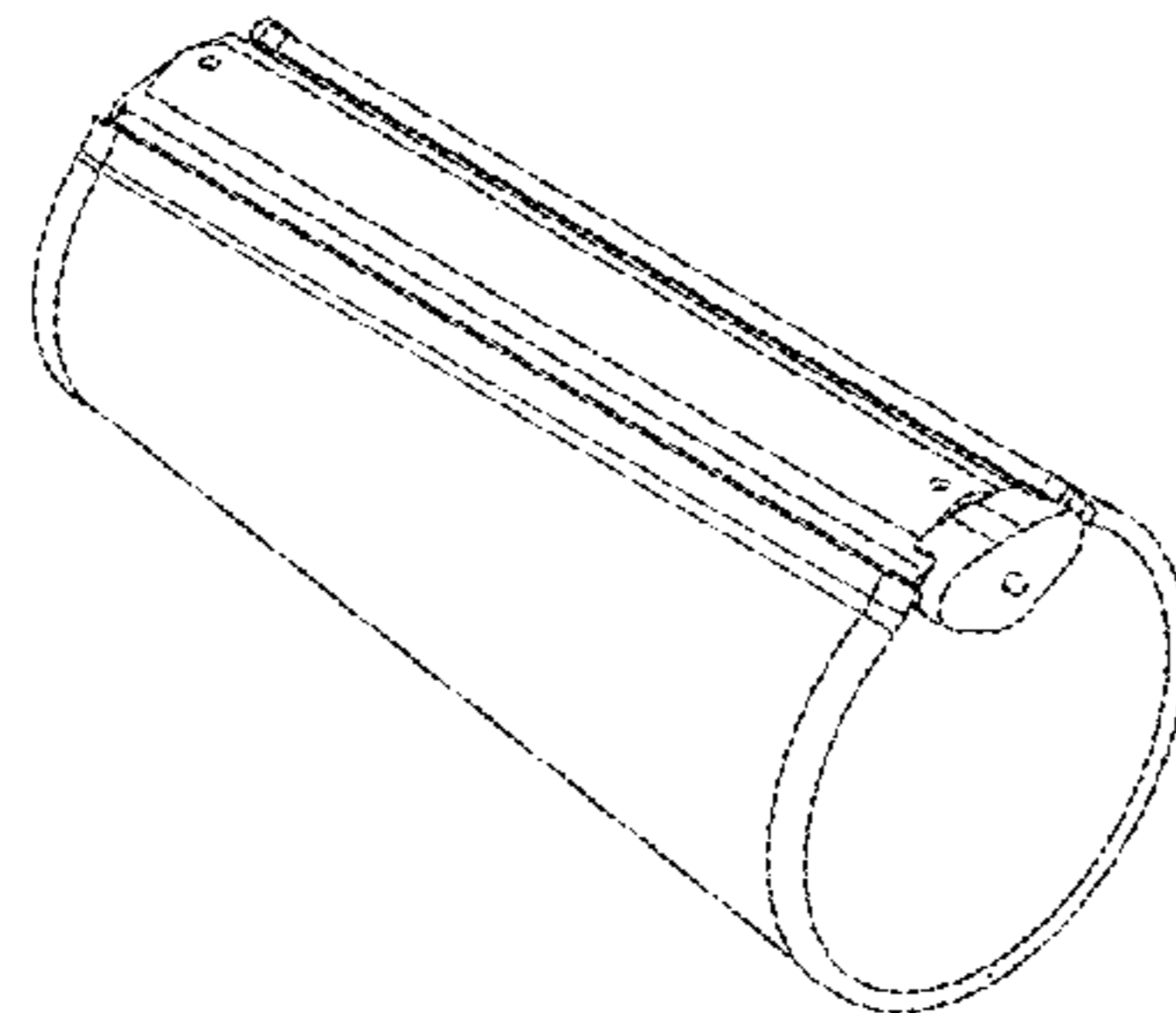

(56)

**References Cited**

U.S. PATENT DOCUMENTS

2014/0340858 A1\* 11/2014 Eom ..... G09F 9/301  
361/749  
2014/0362512 A1\* 12/2014 Hinson ..... G06F 15/025  
361/679.21  
2016/0284254 A1\* 9/2016 Scaturro ..... G09F 17/00

\* cited by examiner

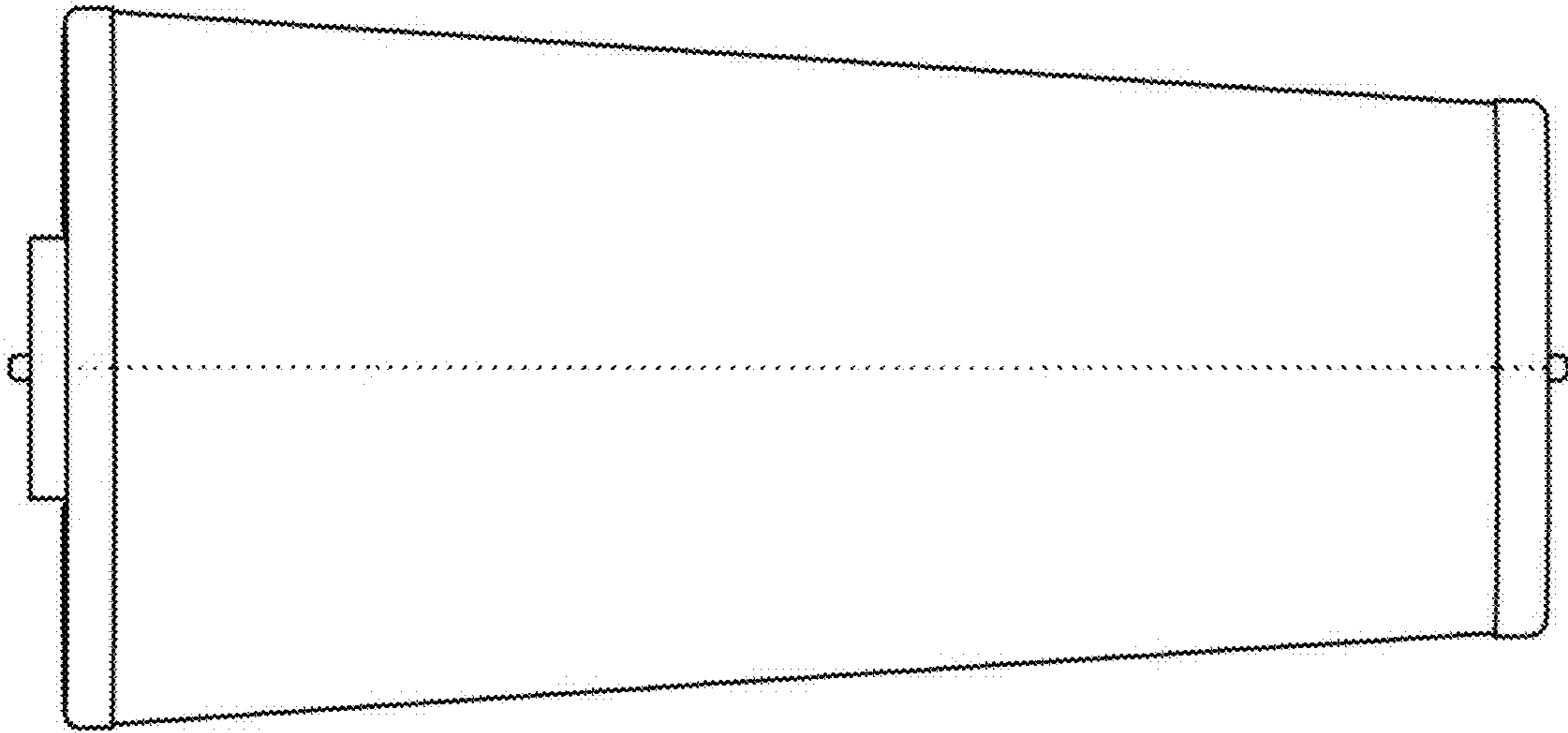

FIG. 1

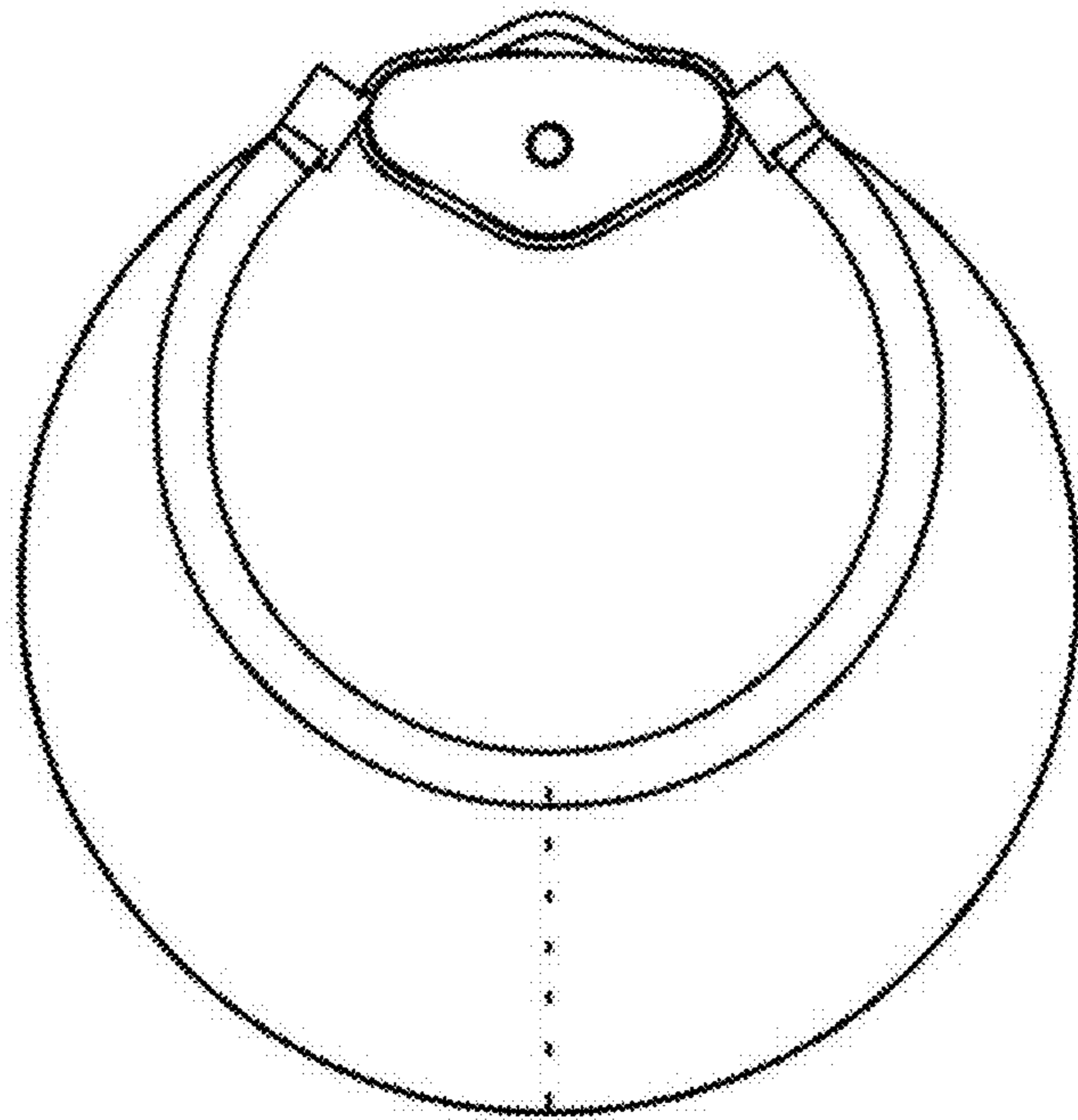

FIG. 2

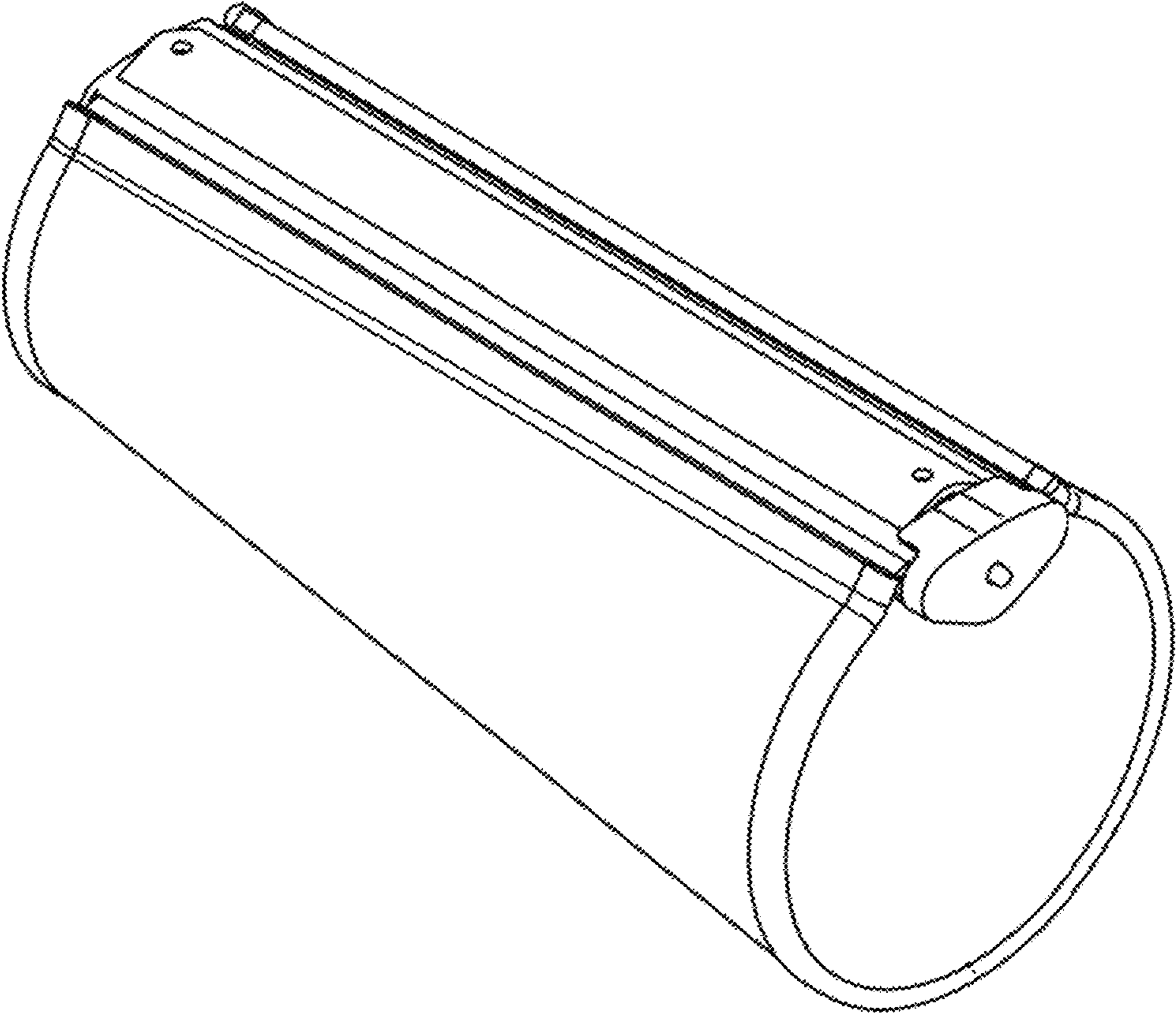

FIG. 3

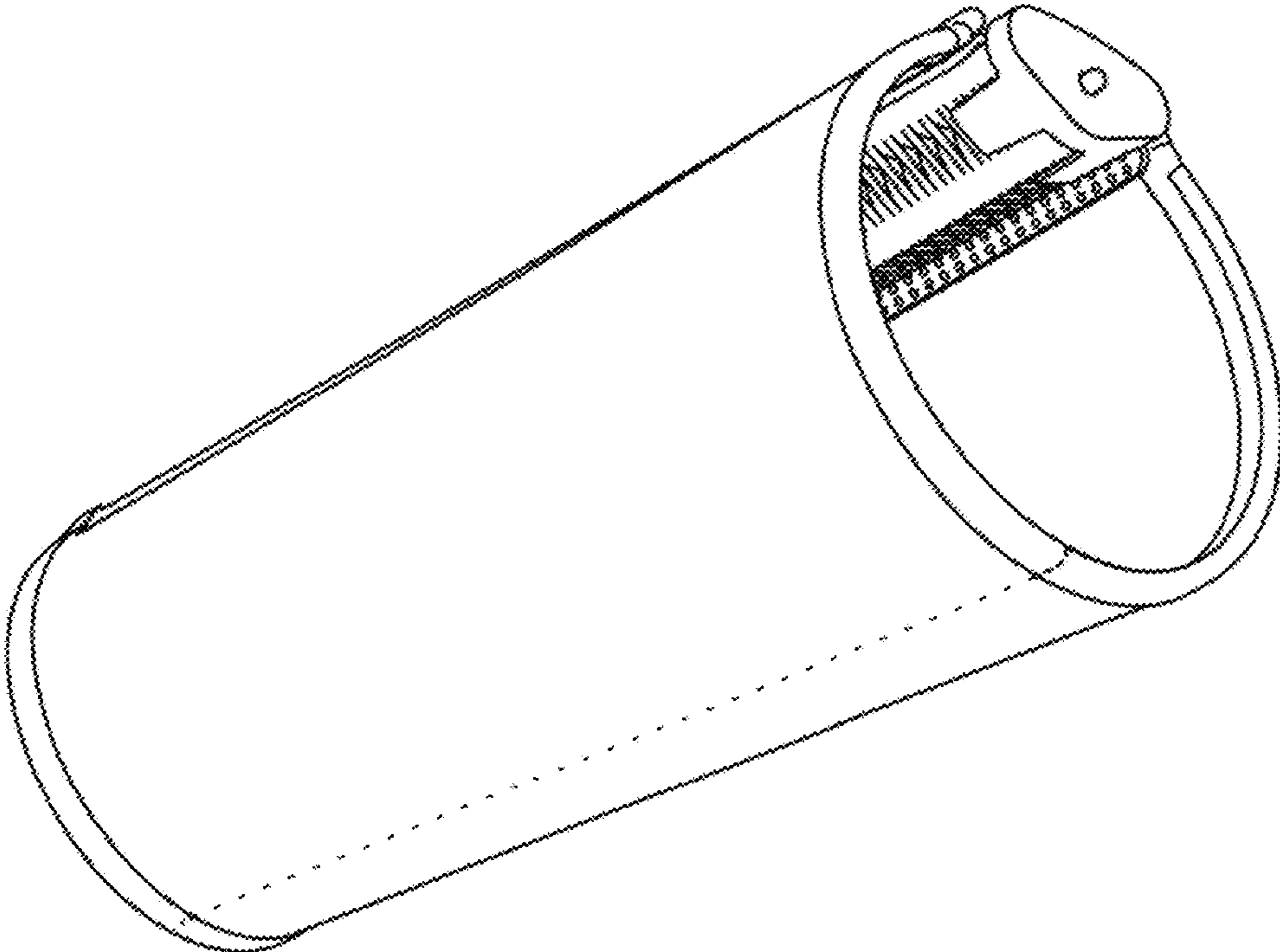

FIG. 4



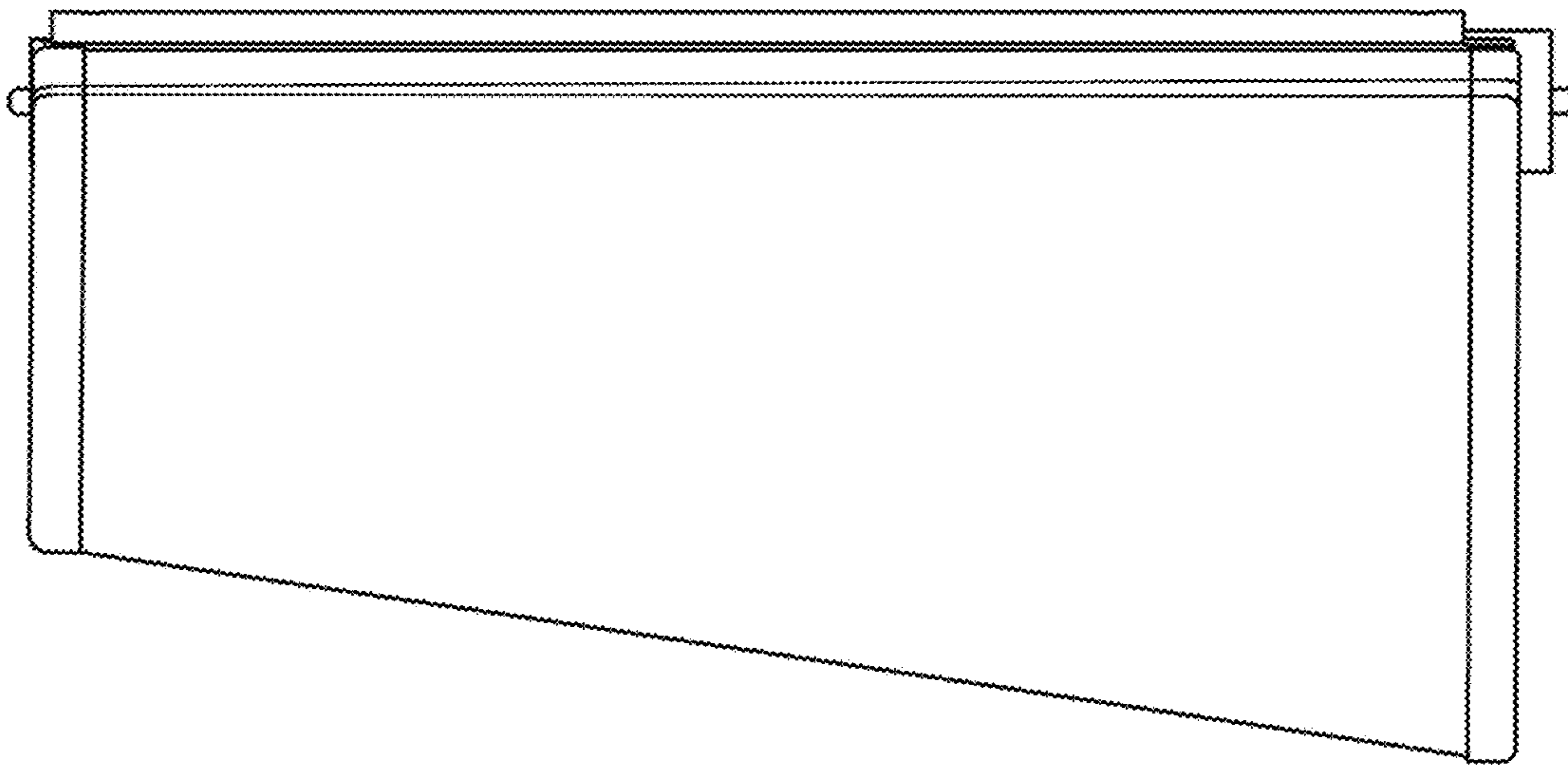

FIG. 5

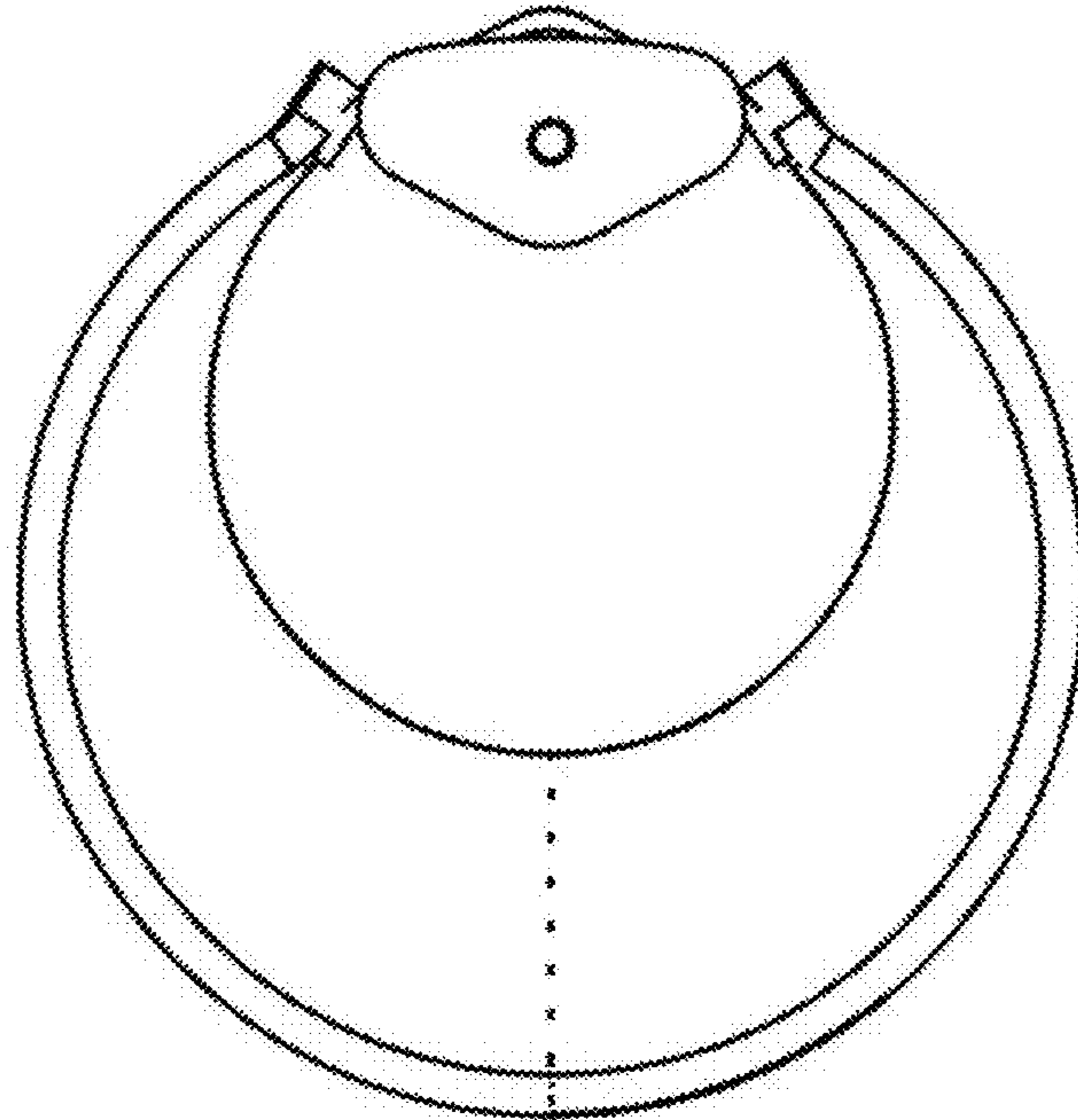

FIG. 6



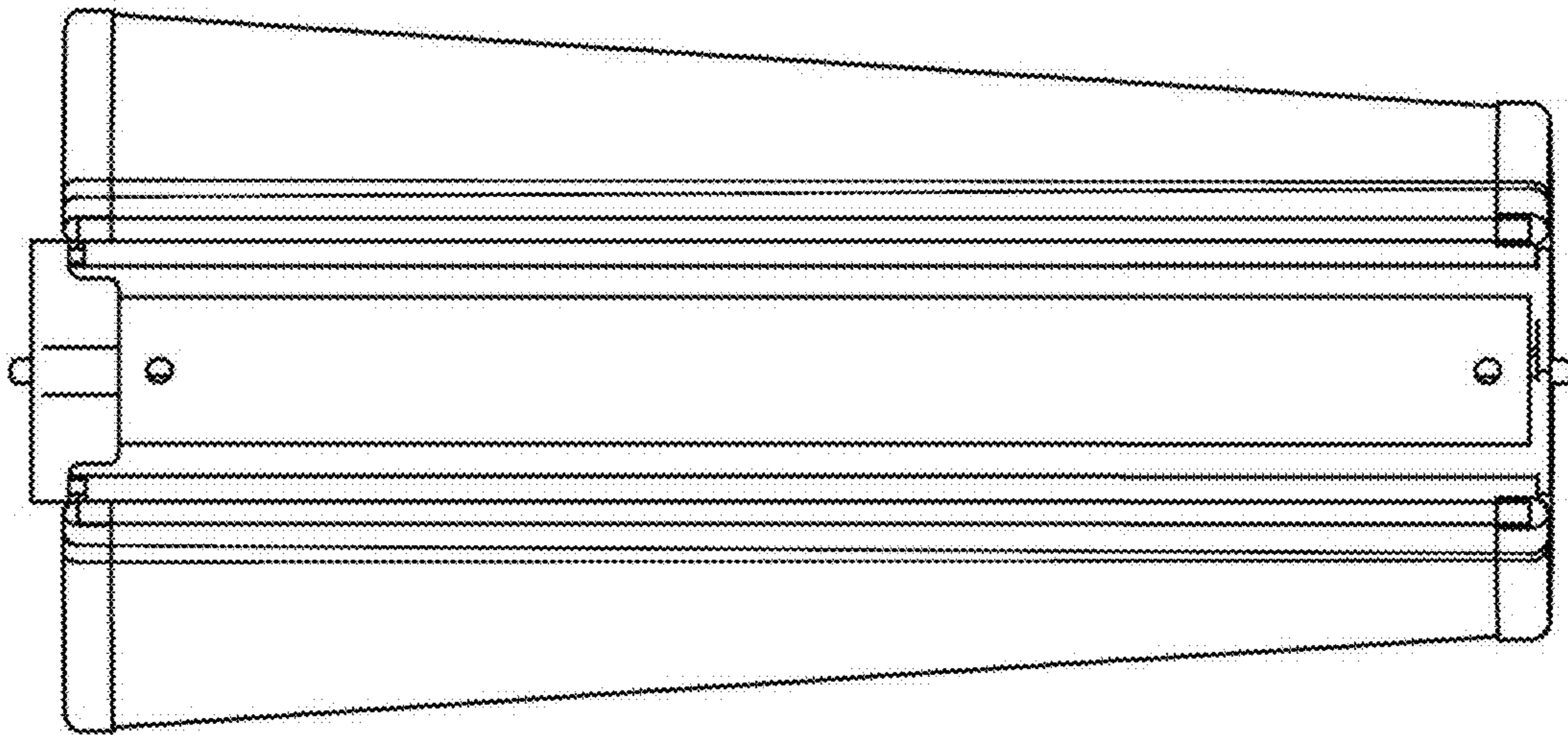

FIG. 7

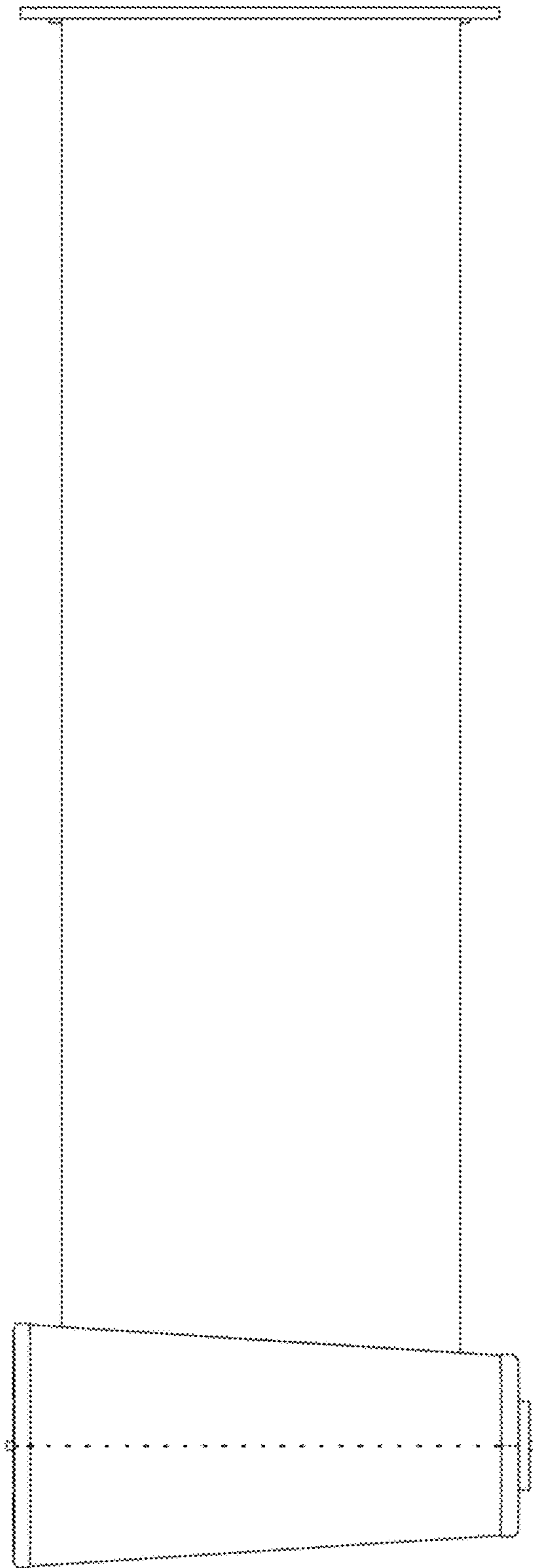

FIG. 8

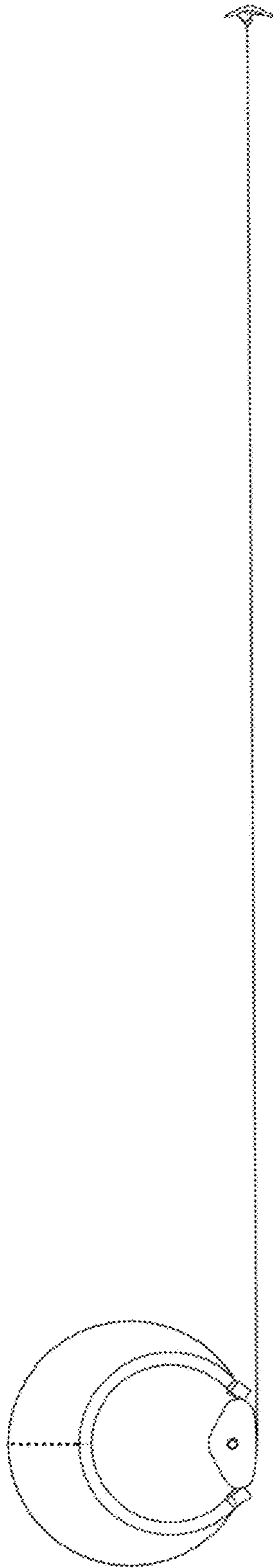

FIG. 9

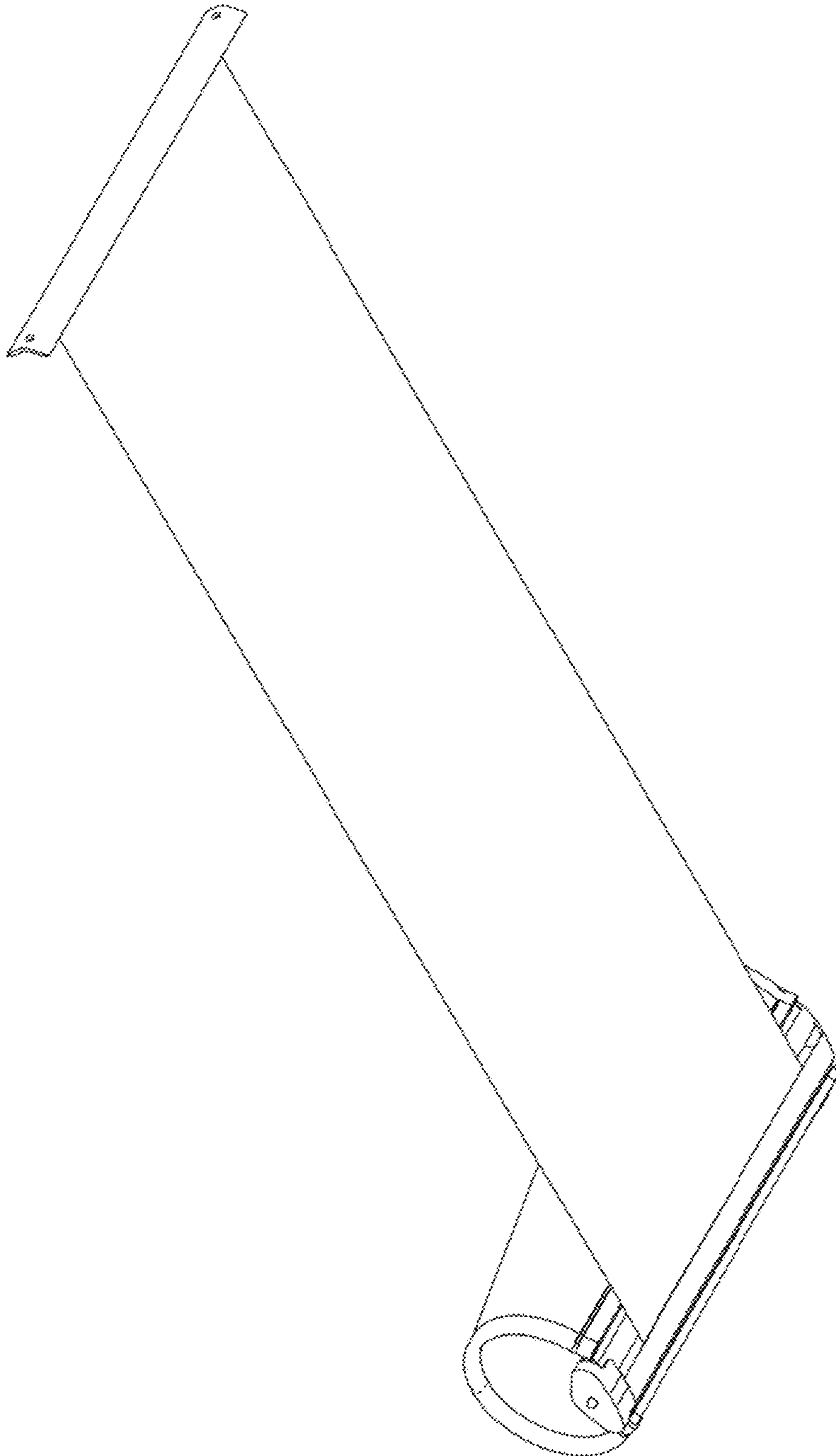

FIG. 10

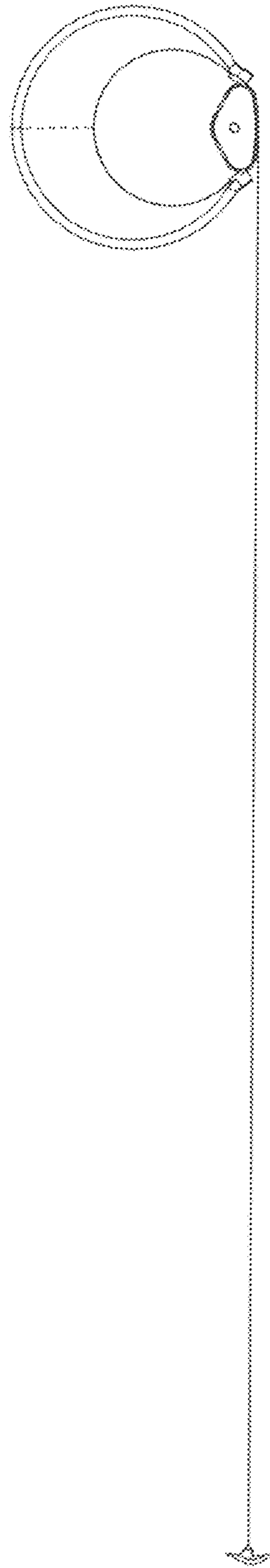

FIG. 11

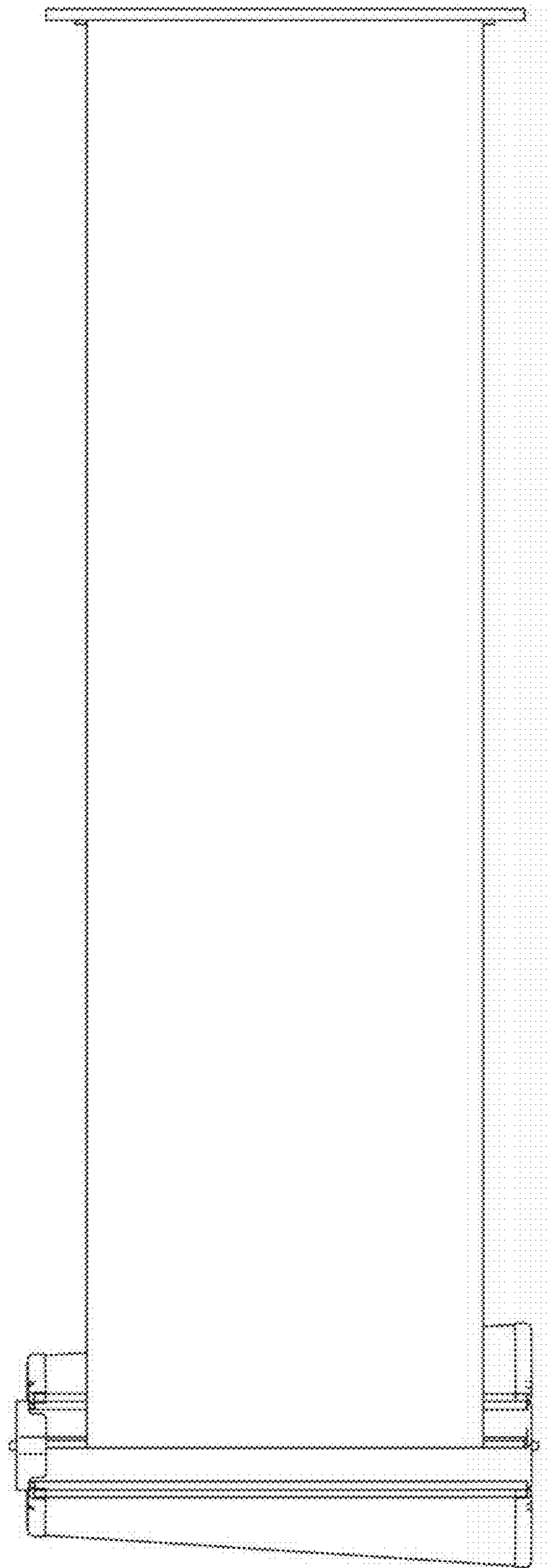

FIG. 12