



US00D836134S

(12) **United States Design Patent**
Hong

(10) **Patent No.:** **US D836,134 S**

(45) **Date of Patent:** **** Dec. 18, 2018**

(54) **DISPLAY SCREEN OR PORTION THEREOF WITH A GRAPHICAL USER INTERFACE HAVING A TRANSITIONAL ICON**

(71) Applicant: **SAP SE**, Walldorf (DE)

(72) Inventor: **Richard Hong**, San Jose, CA (US)

(73) Assignee: **SAP SE**, Walldorf (DE)

(**) Term: **15 Years**

(21) Appl. No.: **29/578,626**

(22) Filed: **Sep. 22, 2016**

(51) **LOC (11) Cl.** **14-04**

(52) **U.S. Cl.**
USPC **D14/492**

(58) **Field of Classification Search**
USPC D14/485–495
CPC G06F 2203/04807; G06F 3/0481; G06F 3/04817; G06F 17/212; G06T 13/80; G06T 15/02; H04N 1/00424

See application file for complete search history.

(56) **References Cited**

U.S. PATENT DOCUMENTS

D425,497 S *	5/2000	Eisenberg	D14/487
D446,790 S *	8/2001	Wang	D14/486
D454,574 S *	3/2002	Wasko	D14/487
D521,521 S *	5/2006	Jewitt	D14/487
D641,372 S *	7/2011	Gardner	D14/486
D644,662 S *	9/2011	Gardner	D14/491
D671,136 S *	11/2012	Barnett	D14/487
D726,214 S *	4/2015	Wantland	D14/487
D737,310 S *	8/2015	Ma	D14/487
D740,834 S *	10/2015	Song	D14/485
D740,835 S *	10/2015	Song	D14/485
D749,626 S *	2/2016	Park	D14/488
D750,098 S *	2/2016	Song	D14/485
D750,125 S *	2/2016	Yang	D14/488
D753,676 S *	4/2016	Oh	D14/485
D754,728 S *	4/2016	Akana	D14/488
D758,394 S *	6/2016	Weber	D14/486
D758,420 S *	6/2016	Zhou	D14/488
D759,677 S *	6/2016	Oguntebi	D14/485
D764,520 S *	8/2016	Lee	D14/488
D766,252 S *	9/2016	Miyazaki	D14/485
D768,185 S *	10/2016	Lee	D14/487
D771,060 S *	11/2016	Miyazaki	D14/485
D773,502 S *	12/2016	Park	D14/486

D776,124 S *	1/2017	Lee	D14/485
D780,769 S *	3/2017	Mensing	D14/485
D782,503 S *	3/2017	Lee	D14/485
D783,657 S *	4/2017	Pitman	D14/486
D784,366 S *	4/2017	Lee	D14/485
D789,976 S *	6/2017	Gibson	D14/488
D797,793 S *	9/2017	Nichols	D14/486
D798,334 S *	9/2017	Dye	D14/489
D802,607 S *	11/2017	Apodaca	D14/485
D806,093 S *	12/2017	Lee	D14/485
D807,907 S *	1/2018	Dellinger	D14/486
D809,006 S *	1/2018	Mehta	D14/489
D813,900 S *	3/2018	Karunamuni	D14/487
D814,504 S *	4/2018	Lee	D14/487
D819,043 S *	5/2018	Yamaura	D14/485
D820,307 S *	6/2018	Jian	D14/489
2014/0137010 A1	5/2014	Matas et al.	
2014/0192229 A1*	7/2014	Kim	348/231.3
2014/0192232 A1*	7/2014	Park	H04N 5/76 348/231.99
2015/0205511 A1	7/2015	Vinna et al.	
2015/0312180 A1	10/2015	Taler	
2015/0370444 A1	12/2015	Jitkoff et al.	
2016/0110085 A1*	4/2016	Barton	H04L 12/2823 715/736
2017/0329464 A1	11/2017	Hong	
2017/0329465 A1	11/2017	Hong	

OTHER PUBLICATIONS

“U.S. Appl. No. 15/348,166, Non Final Office Action dated May 17, 2018”, 12 pgs.

“U.S. Appl. No. 15/348,227, Non Final Office Action dated May 18, 2018”, 16 pgs.

* cited by examiner

Primary Examiner — Philip S Hyder

Assistant Examiner — Cary M Robinson

(74) *Attorney, Agent, or Firm* — Schwegman Lundberg & Woessner, P.A.

(57) **CLAIM**

The ornamental design for a display screen or portion thereof with a graphical user interface having a transitional icon, as shown and described.

DESCRIPTION

FIG. 1 is a front view of a display screen or portion thereof with a graphical user interface having a transitional icon, showing our new design in accordance with a first embodiment and, in particular, showing a first image thereof.

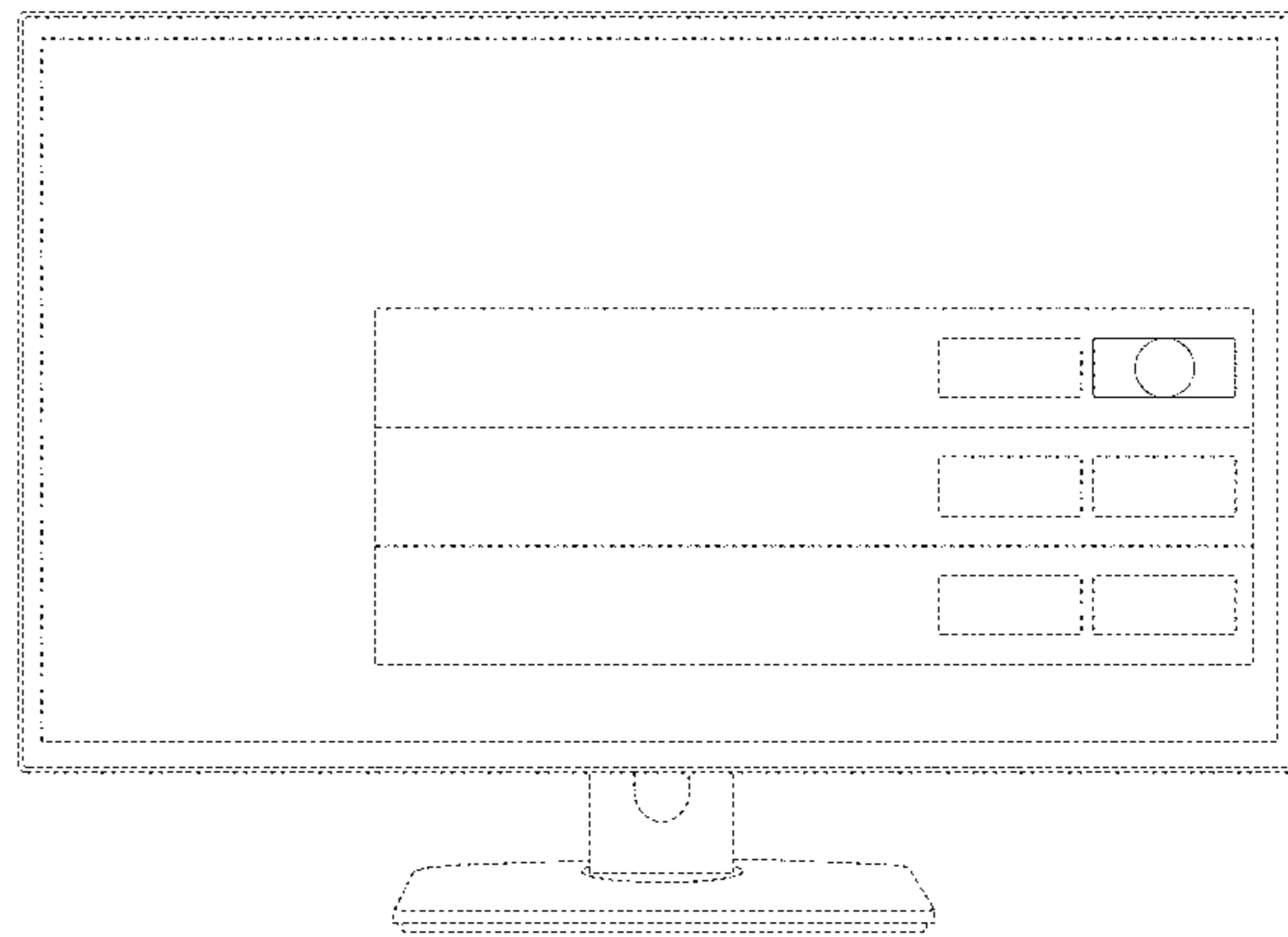
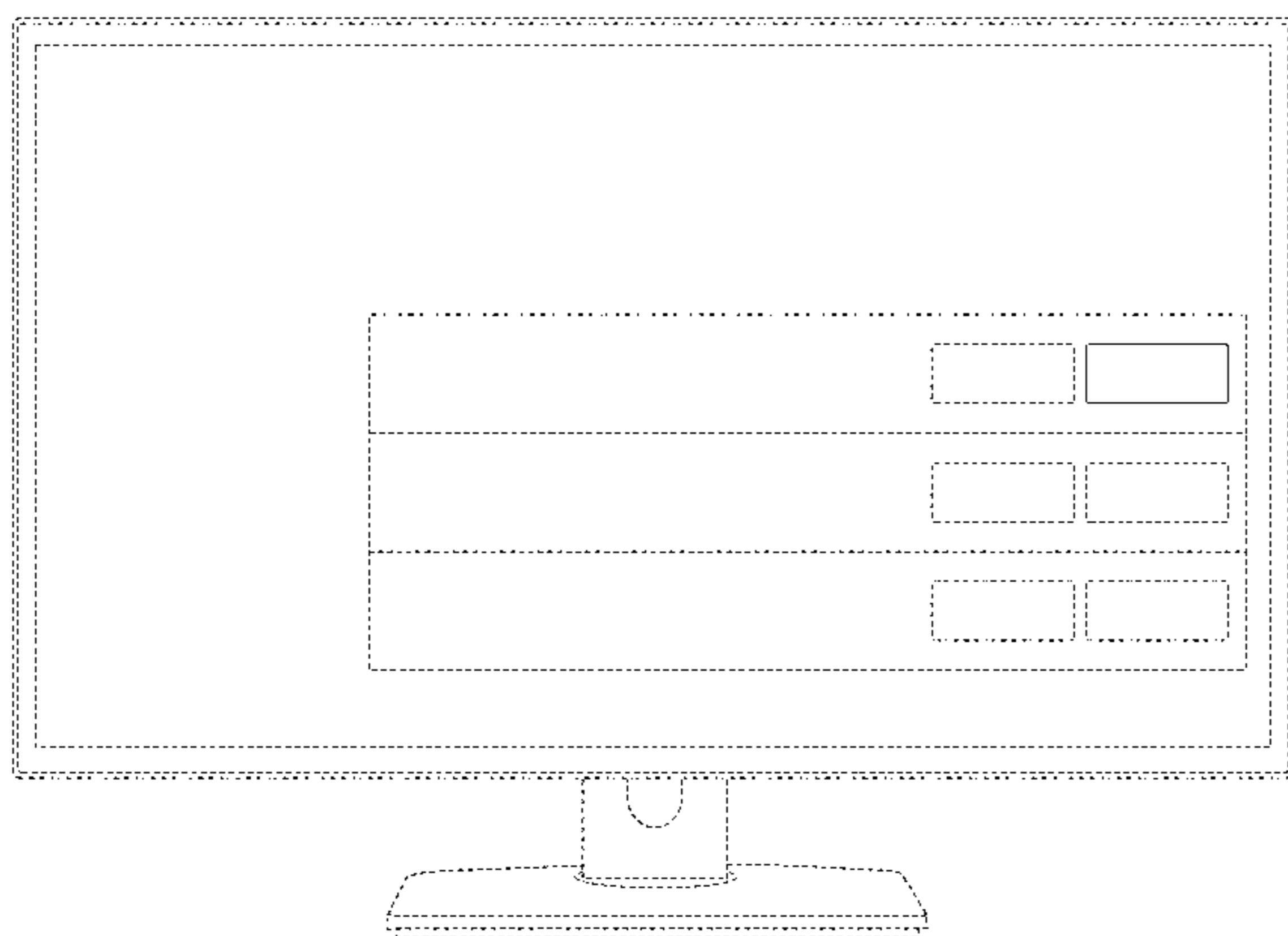

FIG. 2 is a front view of a display screen or portion thereof with a graphical user interface having a transitional icon, showing our new design in accordance with the first embodiment and, in particular, showing a second image thereof.

FIG. 3 is a front view of a display screen or portion thereof with a graphical user interface having a transitional icon, showing our new design in accordance with the first embodiment and, in particular, showing a third image thereof.

FIG. 4 is a front view of the display screen or portion thereof with a graphical user interface having a transitional icon, showing our new design in accordance with the first embodiment and, in particular, showing a fourth image thereof.

FIG. 5 is a front view of the display screen or portion thereof with a graphical user interface having a transitional icon, showing our new design in accordance with the first embodiment and, in particular, showing a fifth image thereof.

FIG. 6 is a front view of the display screen or portion thereof with a graphical user interface having a transitional icon, showing our new design in accordance with the first embodiment and, in particular, showing a sixth image thereof.

FIG. 7 is a front view of the display screen or portion thereof with a graphical user interface having a transitional icon, showing our new design in accordance with the first embodiment and, in particular, showing a seventh image thereof.

FIG. 8 is a front view of the display screen or portion thereof with a graphical user interface having a transitional icon, showing our new design in accordance with the first embodiment and, in particular, showing an eighth image thereof.

FIG. 9 is a front view of the display screen or portion thereof with a graphical user interface having a transitional icon, showing our new design in accordance with the first embodiment and, in particular, showing a ninth image thereof.

FIG. 10 is a front view of the display screen or portion thereof with a graphical user interface having a transitional icon, showing our new design in accordance with the first embodiment and, in particular, showing a tenth image thereof.

FIG. 11 is a front view of the display screen or portion thereof with a graphical user interface having a transitional icon, showing our new design in accordance with the first embodiment and, in particular, showing an eleventh image thereof.

FIG. 12 is a front view of the display screen or portion thereof with a graphical user interface having a transitional icon, showing our new design in accordance with the first embodiment and, in particular, showing a twelfth image thereof.

FIG. 13 is a front view of a display screen or portion thereof with a graphical user interface having a transitional icon, showing our new design in accordance with a second embodiment and, in particular, showing a first image thereof.

FIG. 14 is a front view of a display screen or portion thereof with a graphical user interface having a transitional icon, showing our new design in accordance with the second embodiment and, in particular, showing a second image thereof.

FIG. 15 is a front view of a display screen or portion thereof with a graphical user interface having a transitional icon, showing our new design in accordance with the second embodiment and, in particular, showing a third image thereof.

FIG. 16 is a front view of the display screen or portion thereof with a graphical user interface having a transitional icon, showing our new design in accordance with the second embodiment and, in particular, showing a fourth image thereof.

FIG. 17 is a front view of the display screen or portion thereof with a graphical user interface having a transitional icon, showing our new design in accordance with the second embodiment and, in particular, showing a fifth image thereof.

FIG. 18 is a front view of the display screen or portion thereof with a graphical user interface having a transitional icon, showing our new design in accordance with the second embodiment and, in particular, showing a sixth image thereof.

FIG. 19 is a front view of the display screen or portion thereof with a graphical user interface having a transitional icon, showing our new design in accordance with the second embodiment and, in particular, showing a seventh image thereof.

FIG. 20 is a front view of the display screen or portion thereof with a graphical user interface having a transitional icon, showing our new design in accordance with the second embodiment and, in particular, showing an eighth image thereof.

FIG. 21 is a front view of the display screen or portion thereof with a graphical user interface having a transitional icon, showing our new design in accordance with the second embodiment and, in particular, showing a ninth image thereof.

FIG. 22 is a front view of the display screen or portion thereof with a graphical user interface having a transitional icon, showing our new design in accordance with the second embodiment and, in particular, showing a tenth image thereof.

FIG. 23 is a front view of the display screen or portion thereof with a graphical user interface having a transitional icon, showing our new design in accordance with the second embodiment and, in particular, showing an eleventh image thereof; and,

FIG. 24 is a front view of the display screen or portion thereof with a graphical user interface having a transitional icon, showing our new design in accordance with the second embodiment and, in particular, showing a twelfth image thereof.

The outermost set of broken lines illustrate an electronic device, the broken line at the periphery of the figures illustrate the display screen, and the remainder of the broken lines illustrate portions of the graphical user interface having a transitional icon. None of the broken lines form part of the claimed design.

The appearance of the first embodiment of the graphical user interface with the transitional icon sequentially transitions among the images shown in FIGS. 1-12. The appearance of the second embodiment of the graphical user interface with the transitional icon sequentially transitions among the images shown in FIGS. 13-24. The process or period in which one image transitions to another image forms no part of the claimed design.

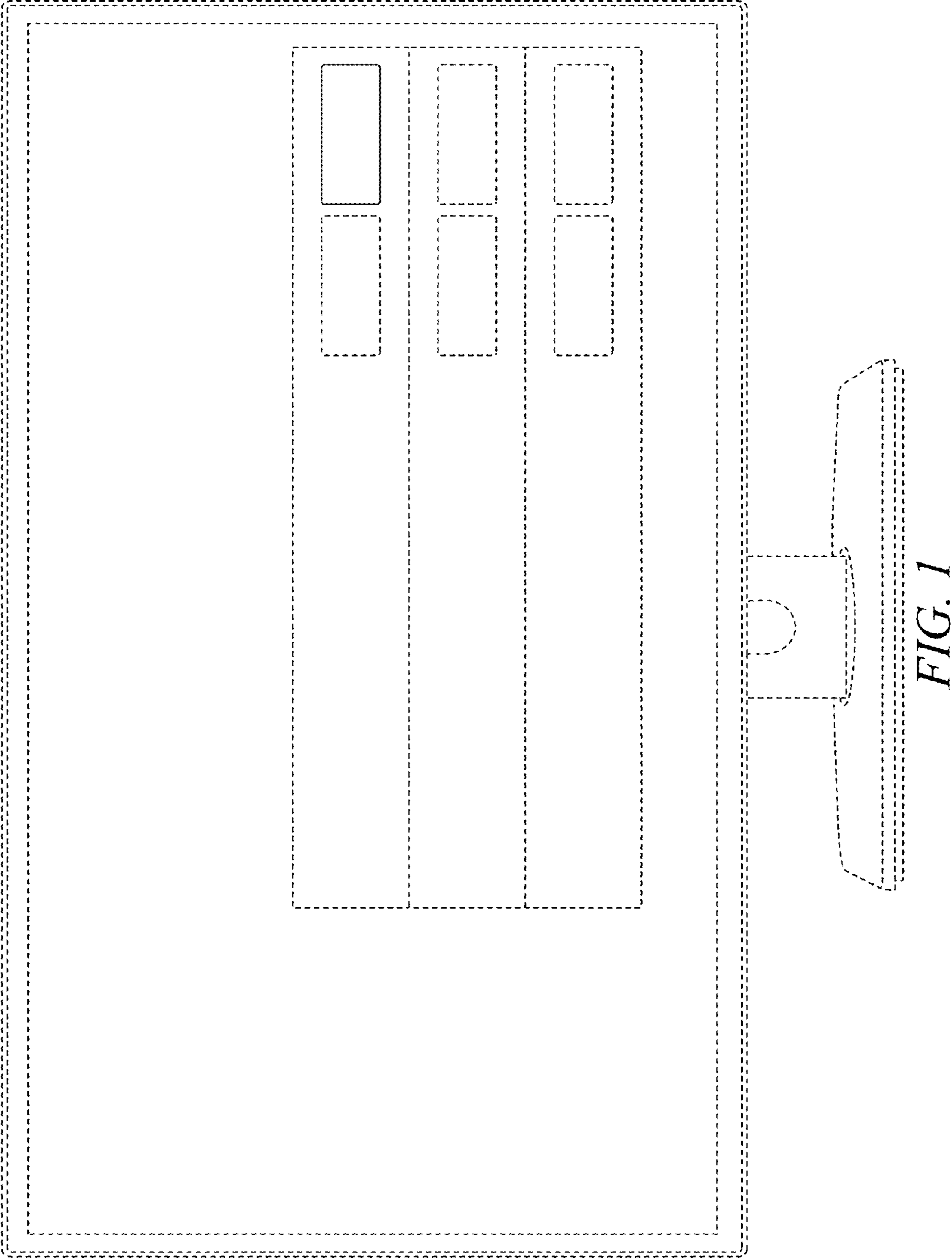

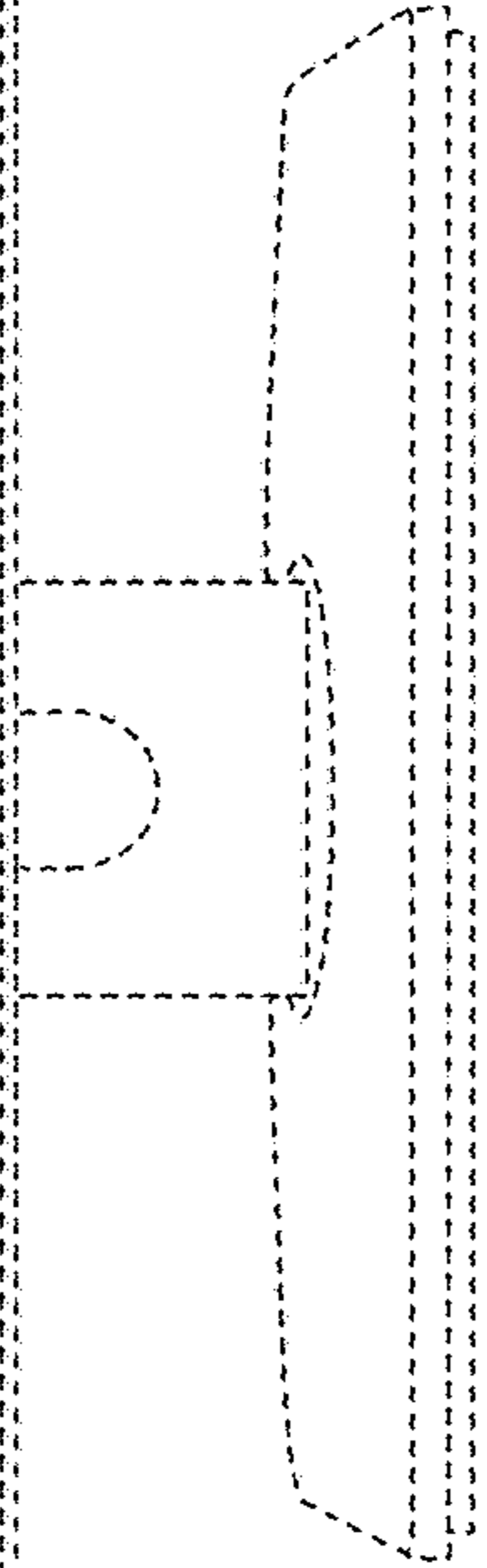
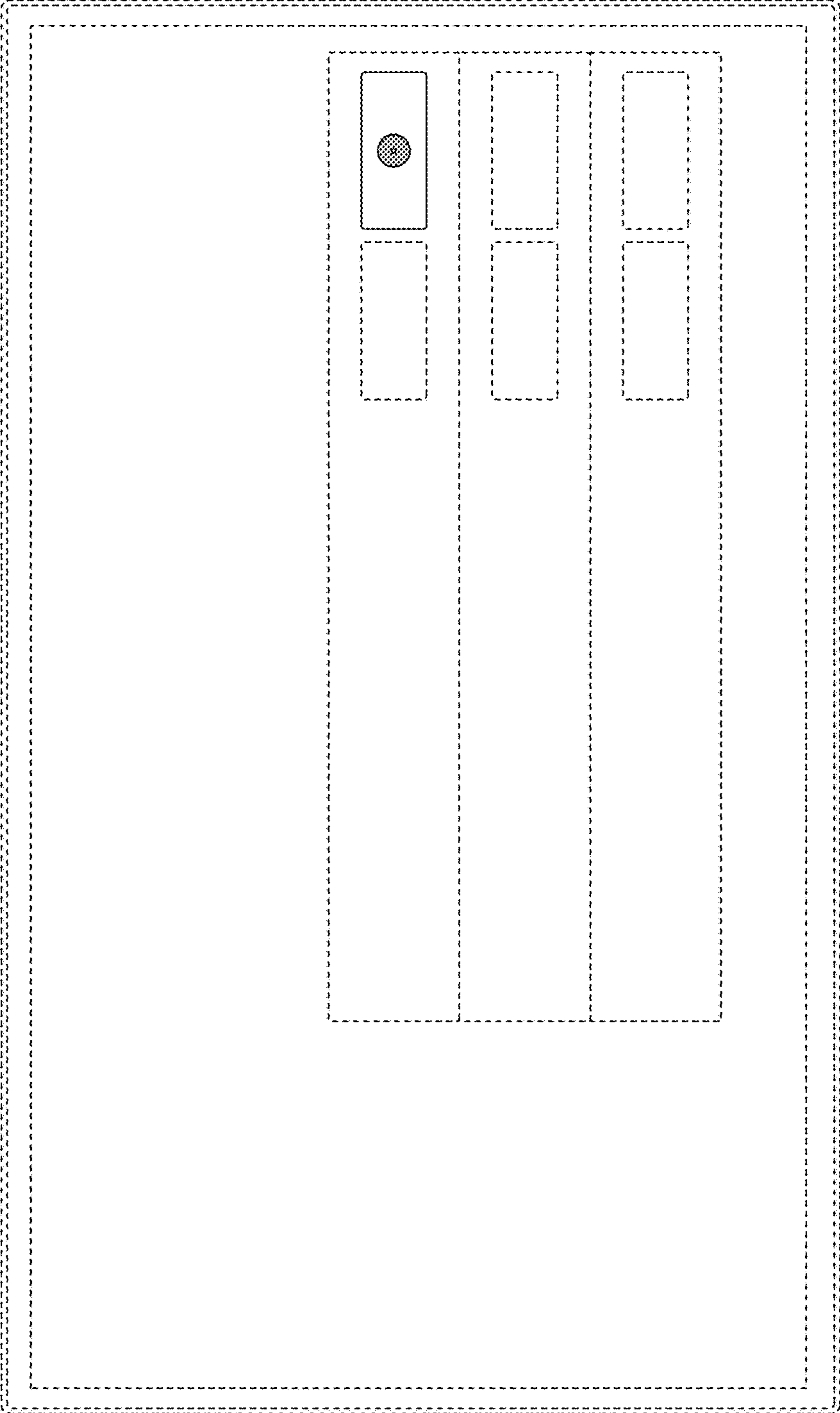

FIG. 2

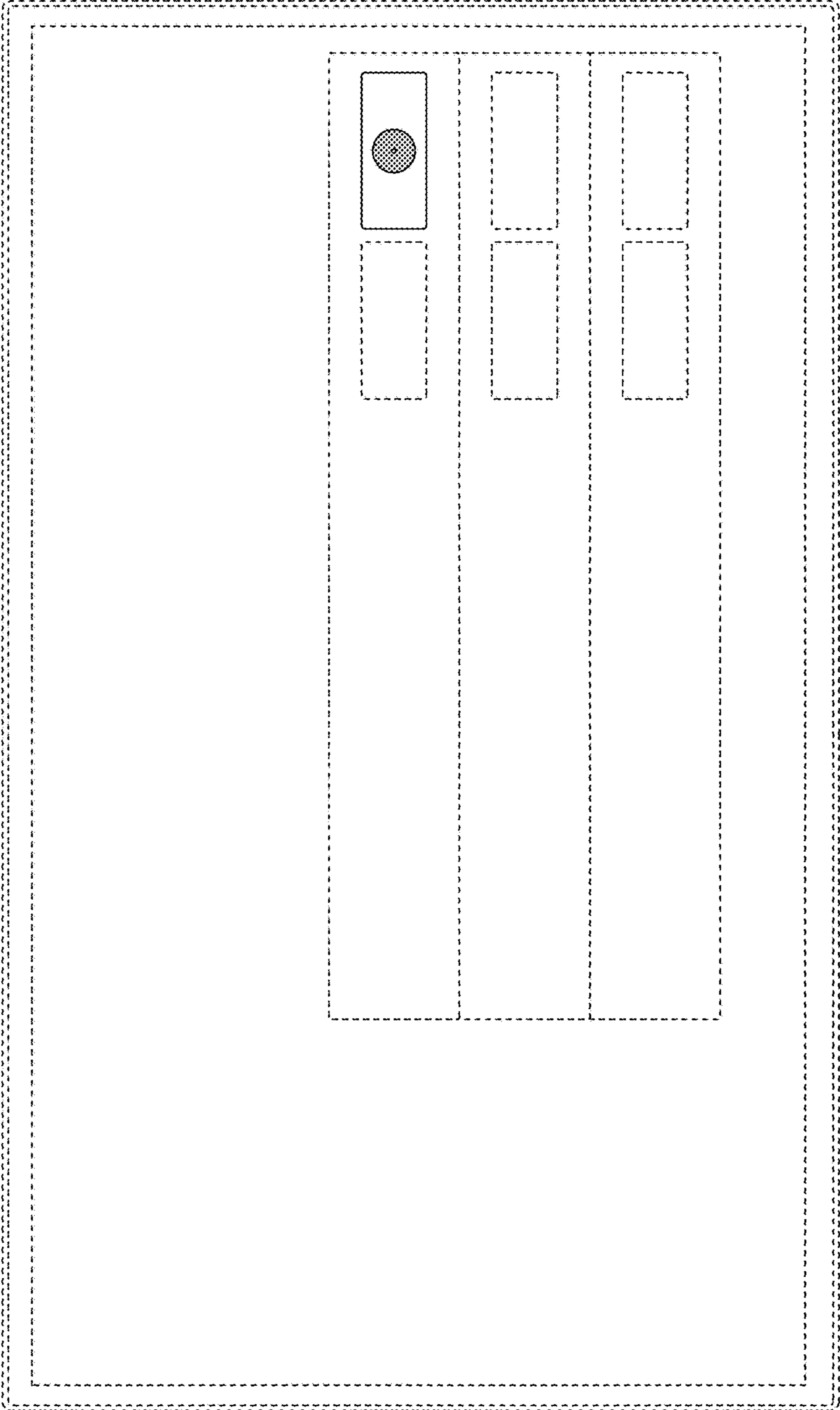
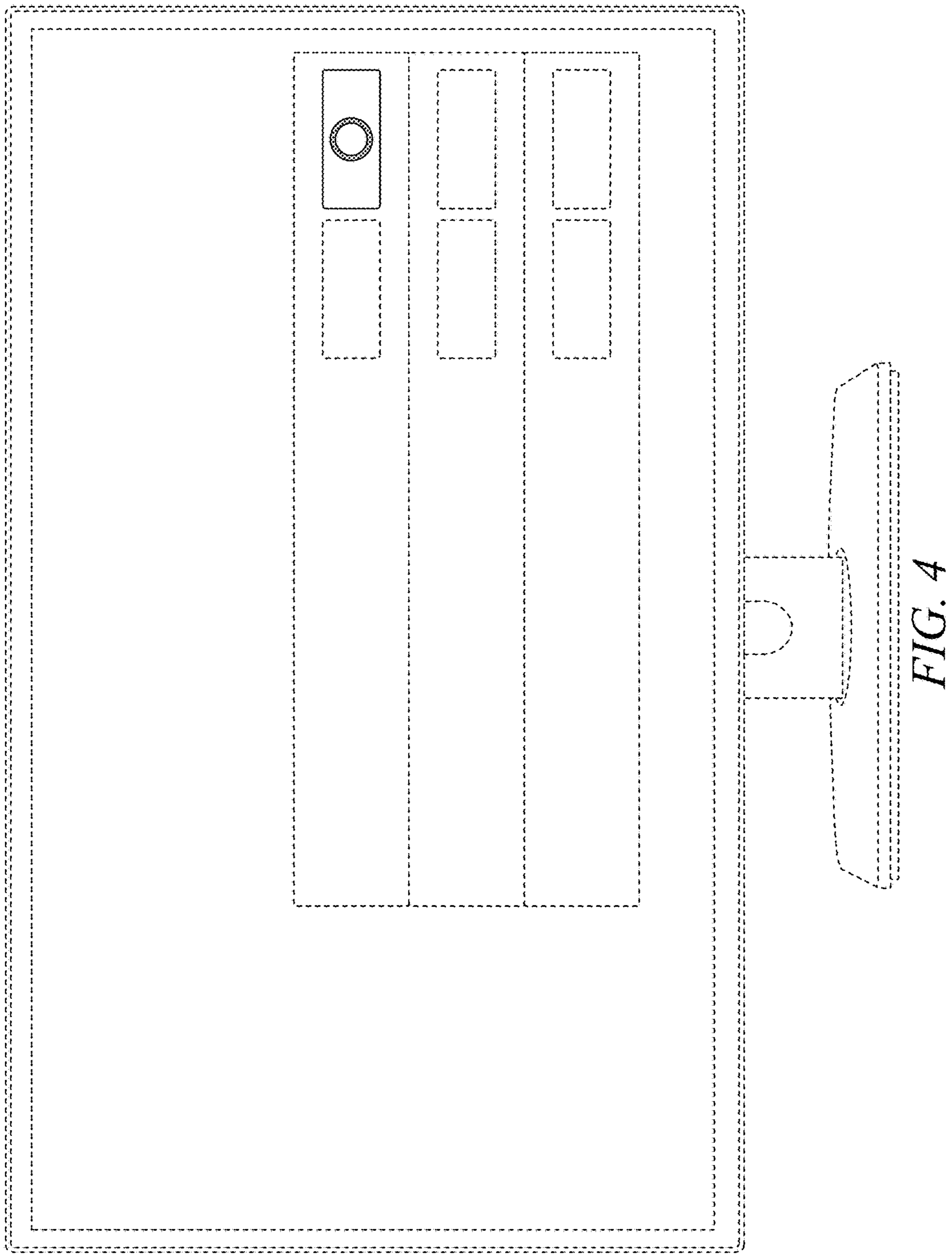
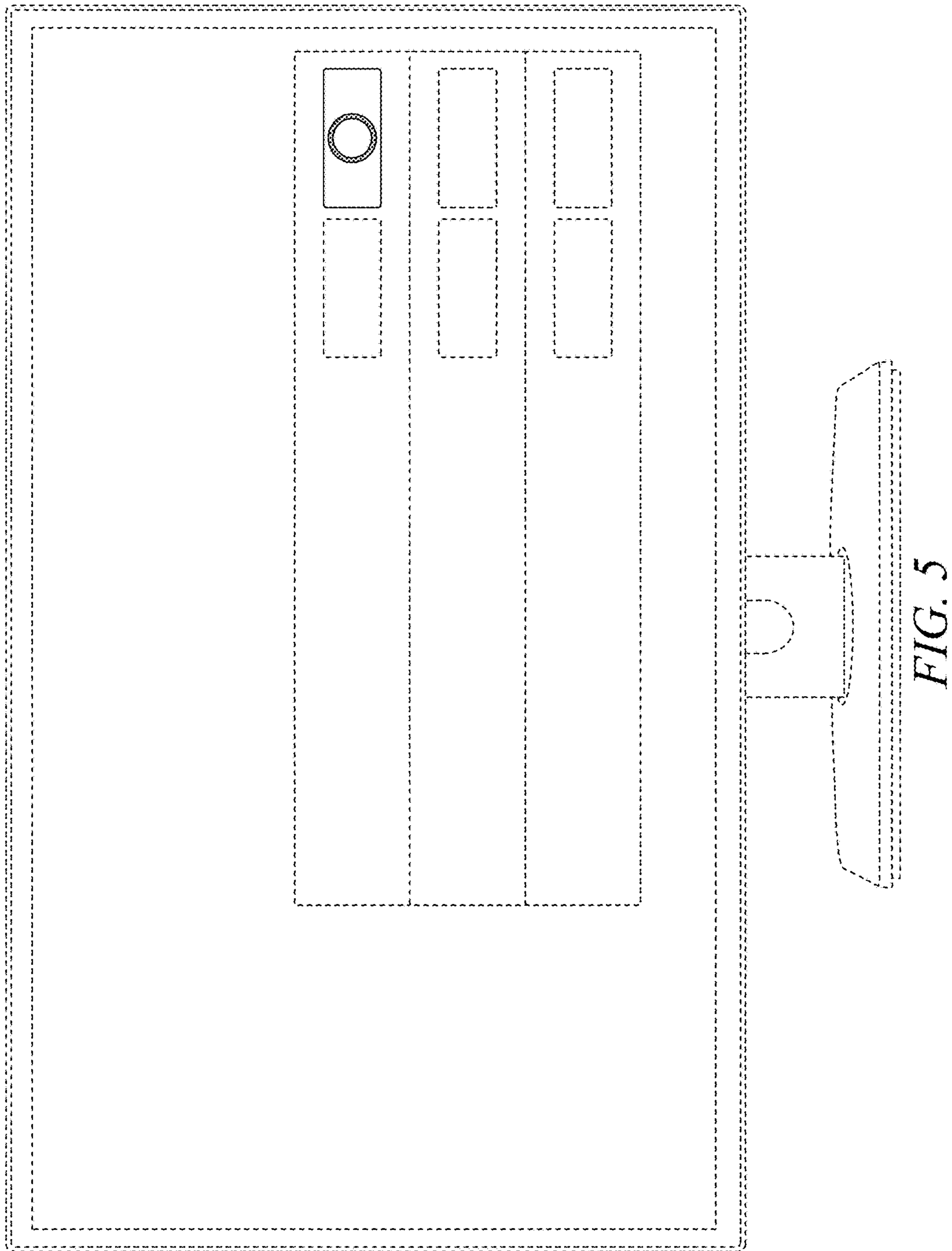

FIG. 3





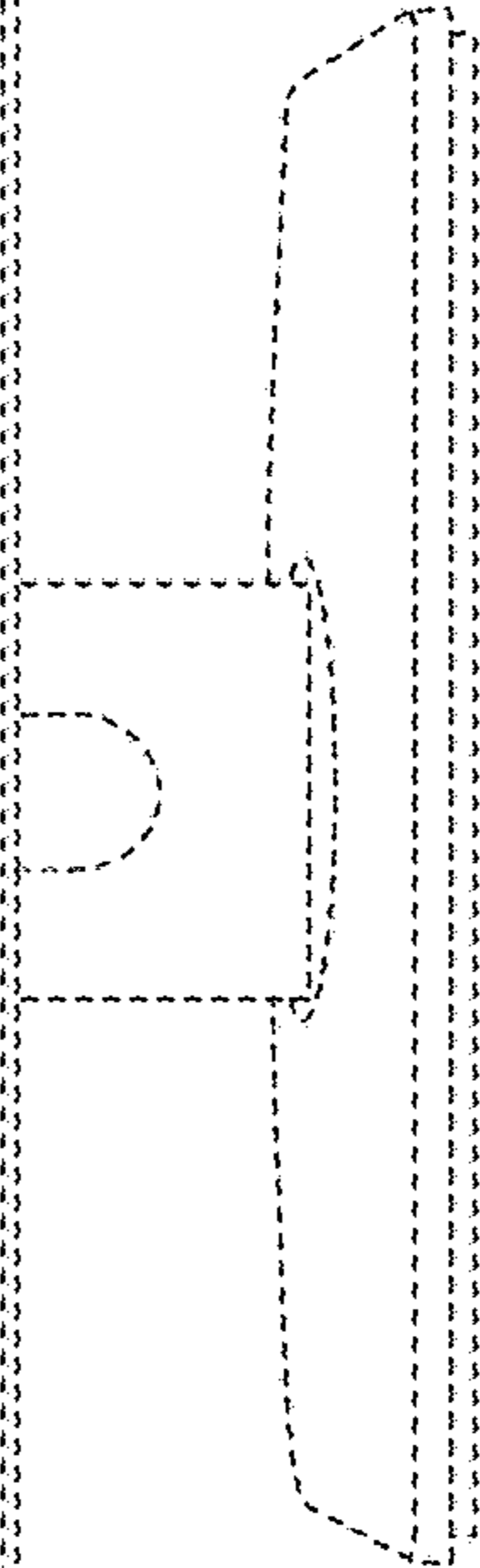
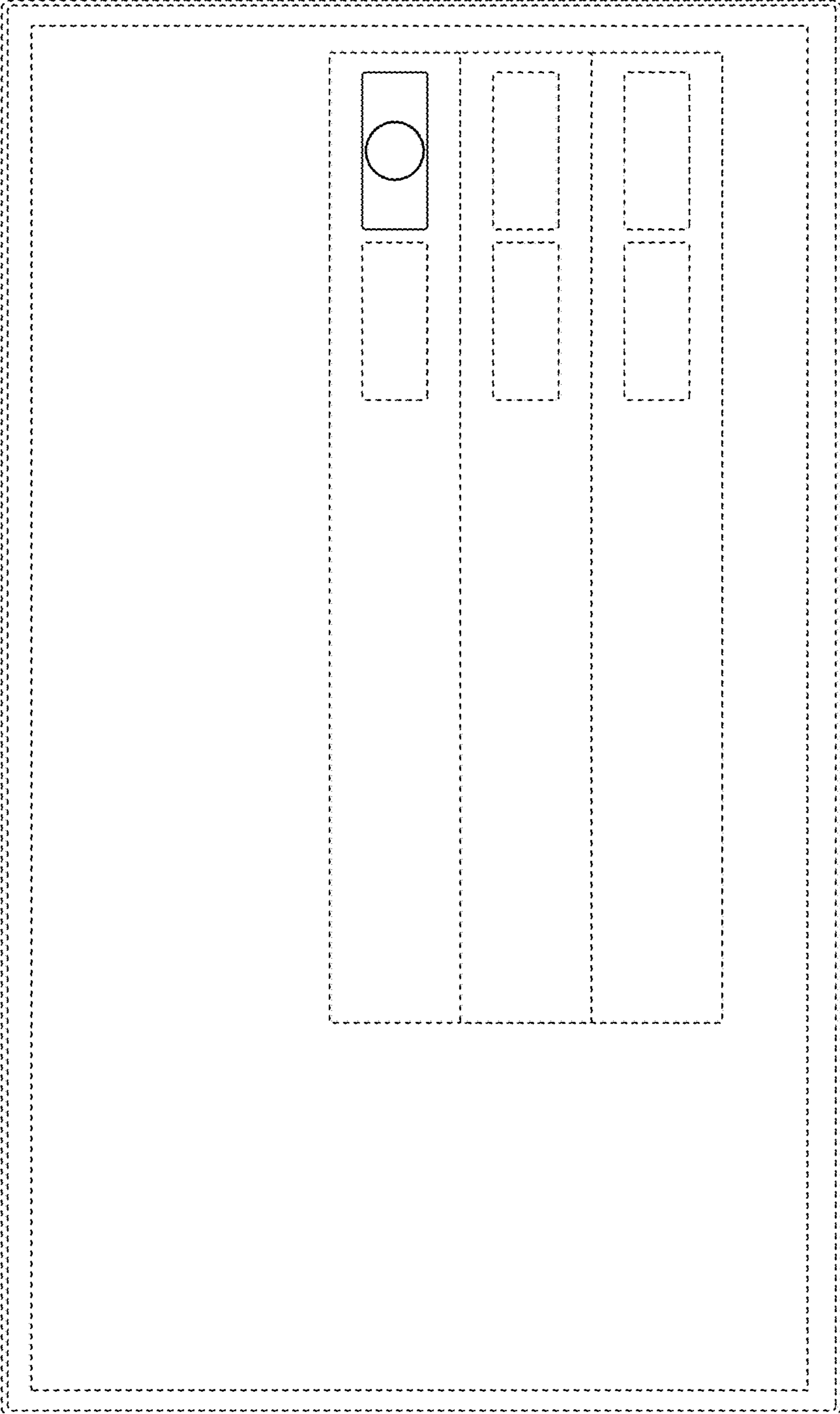
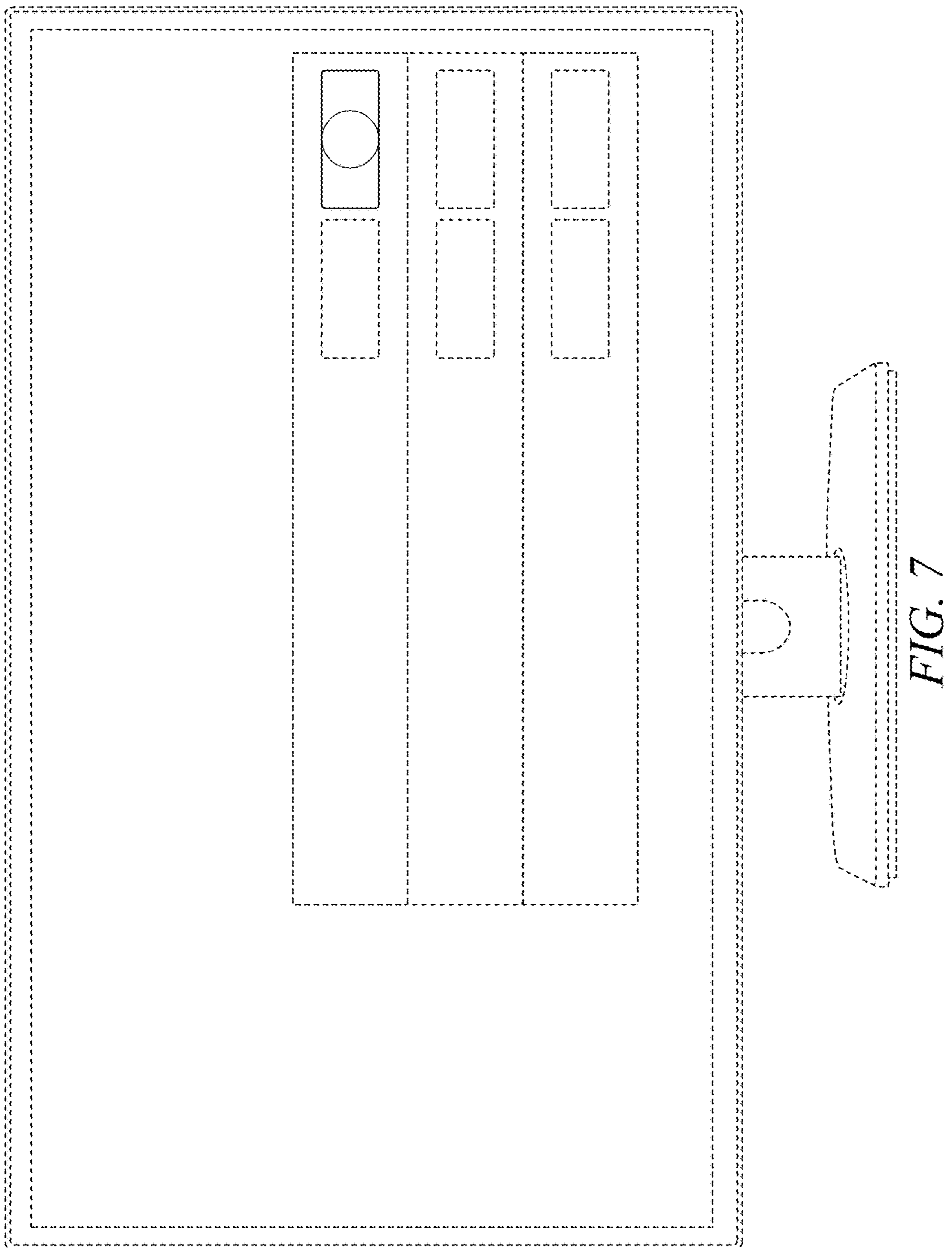

FIG. 6



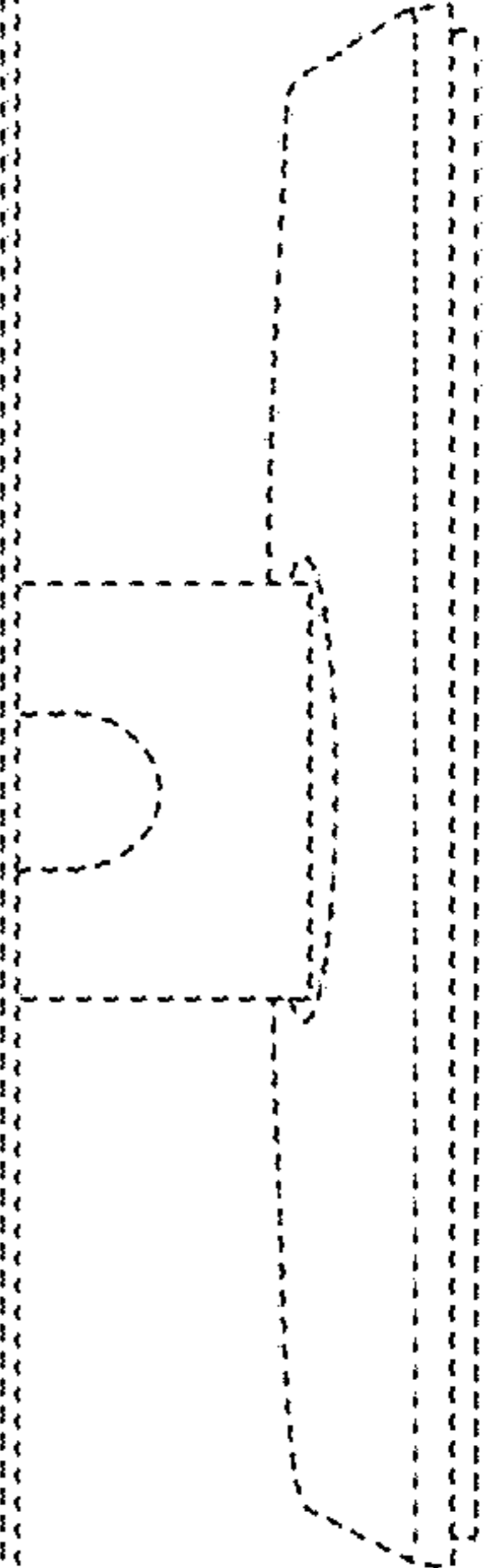
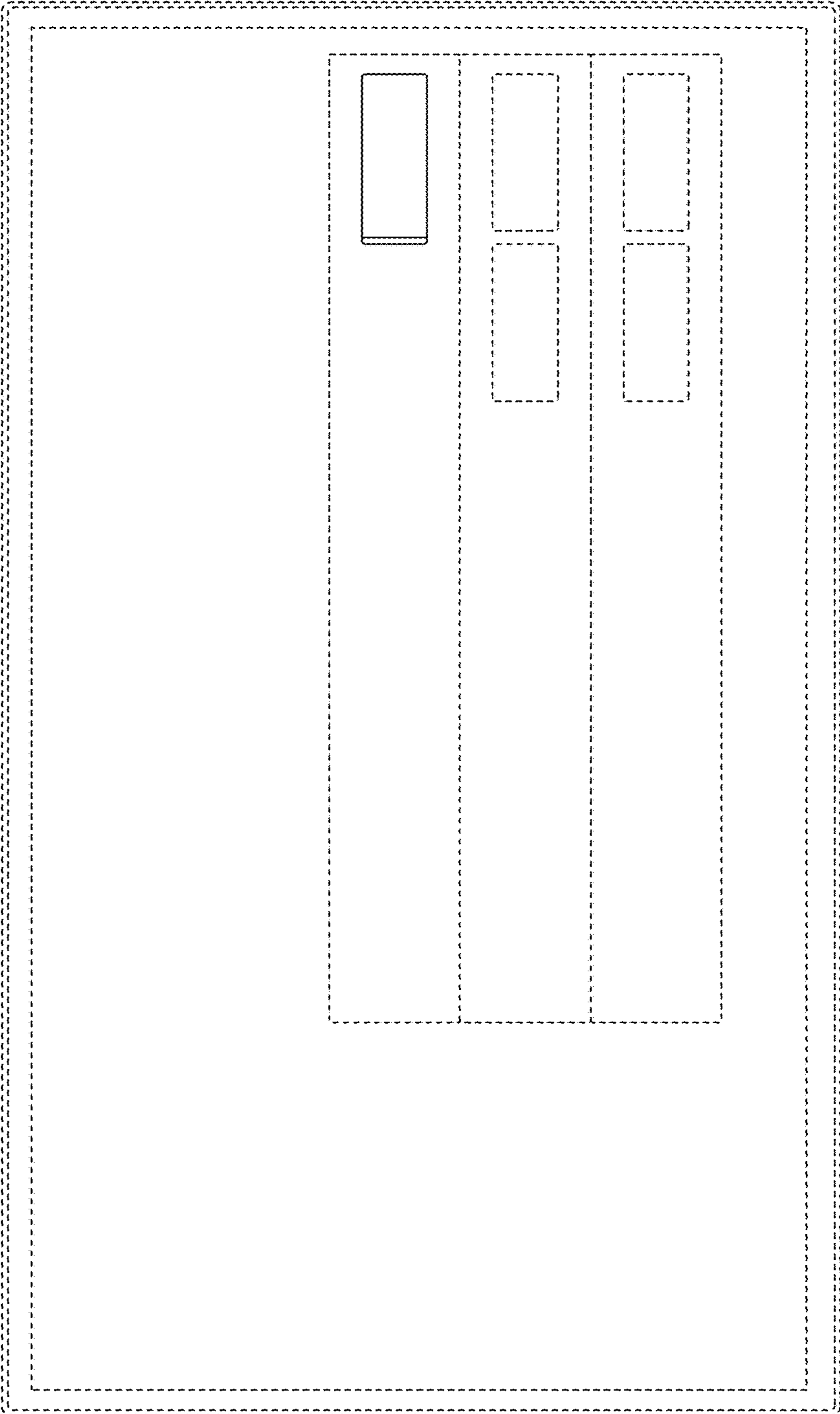

FIG. 8

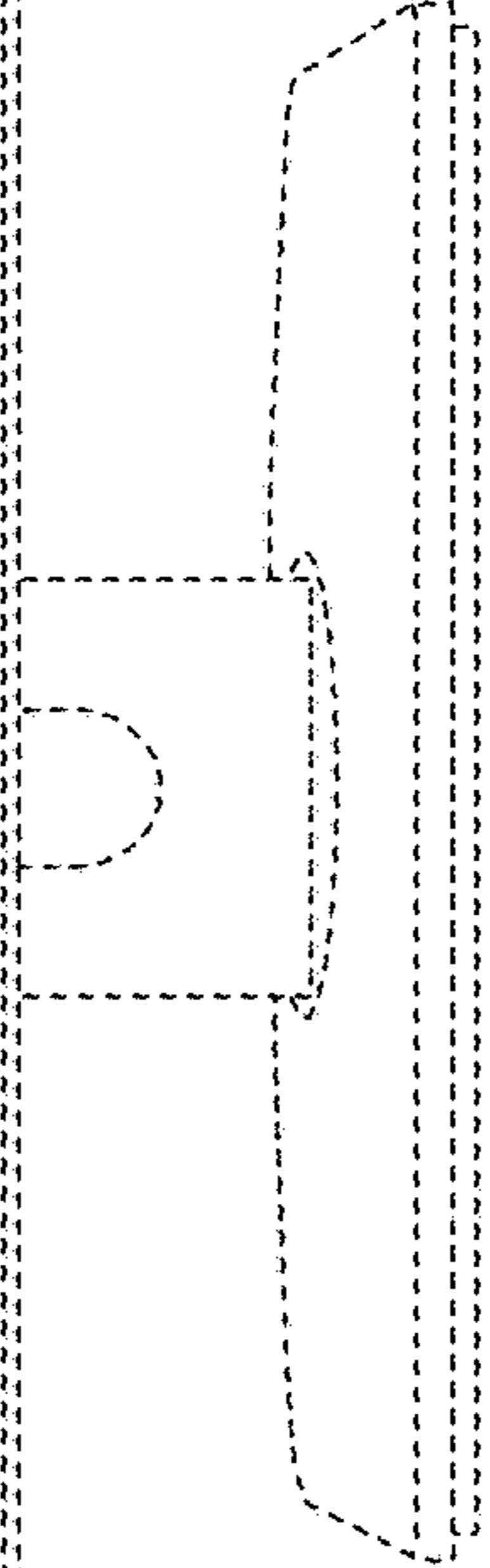
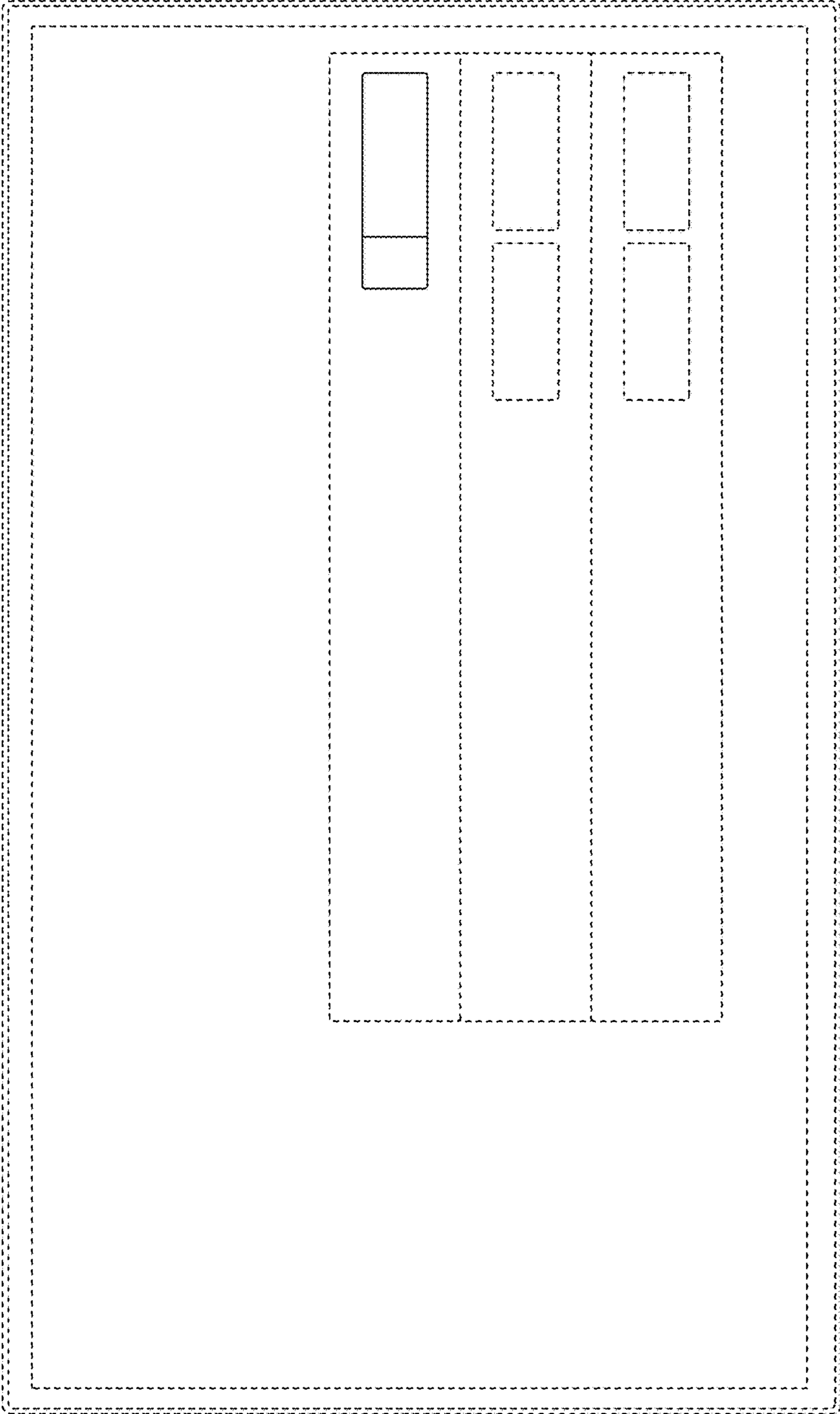
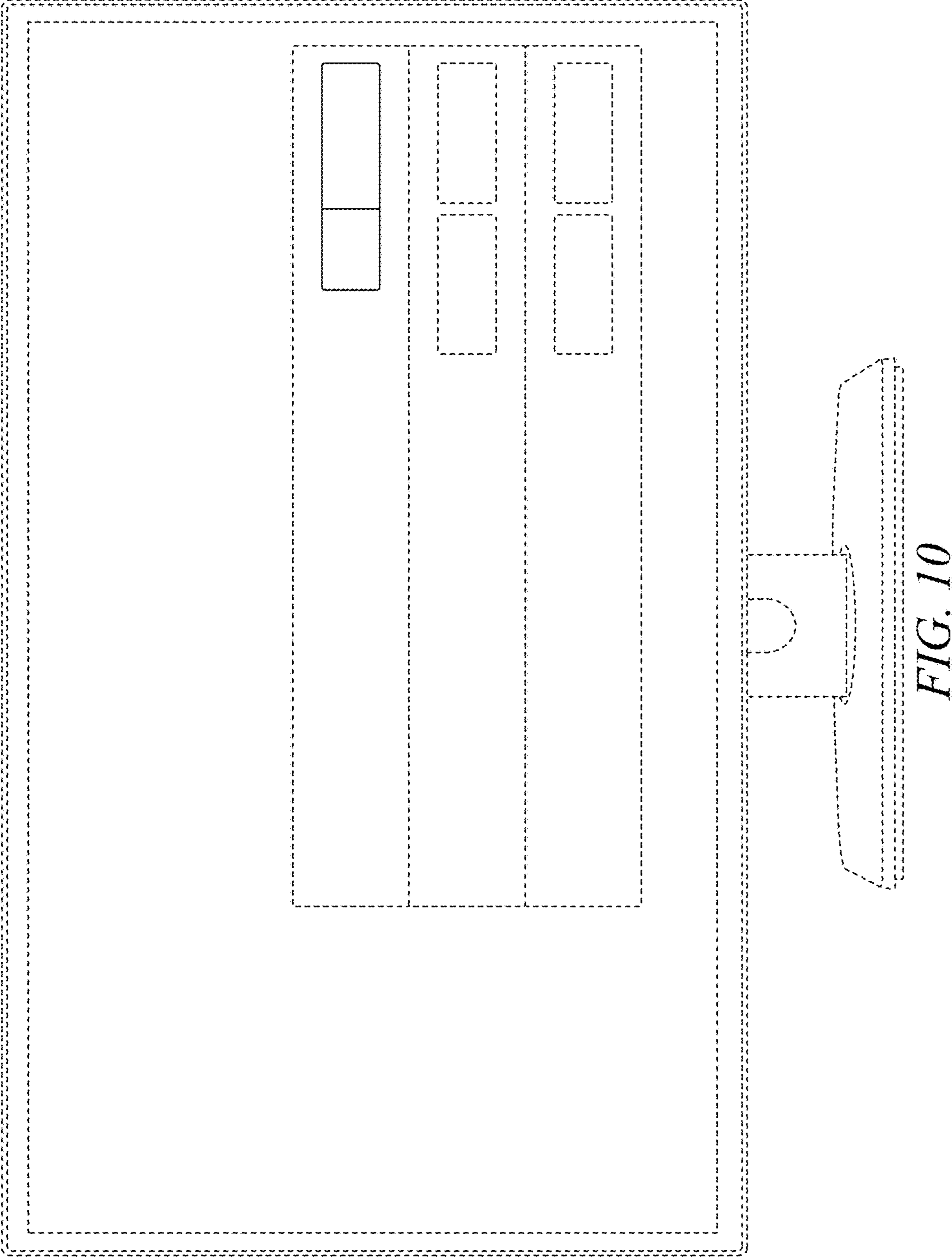

FIG. 9



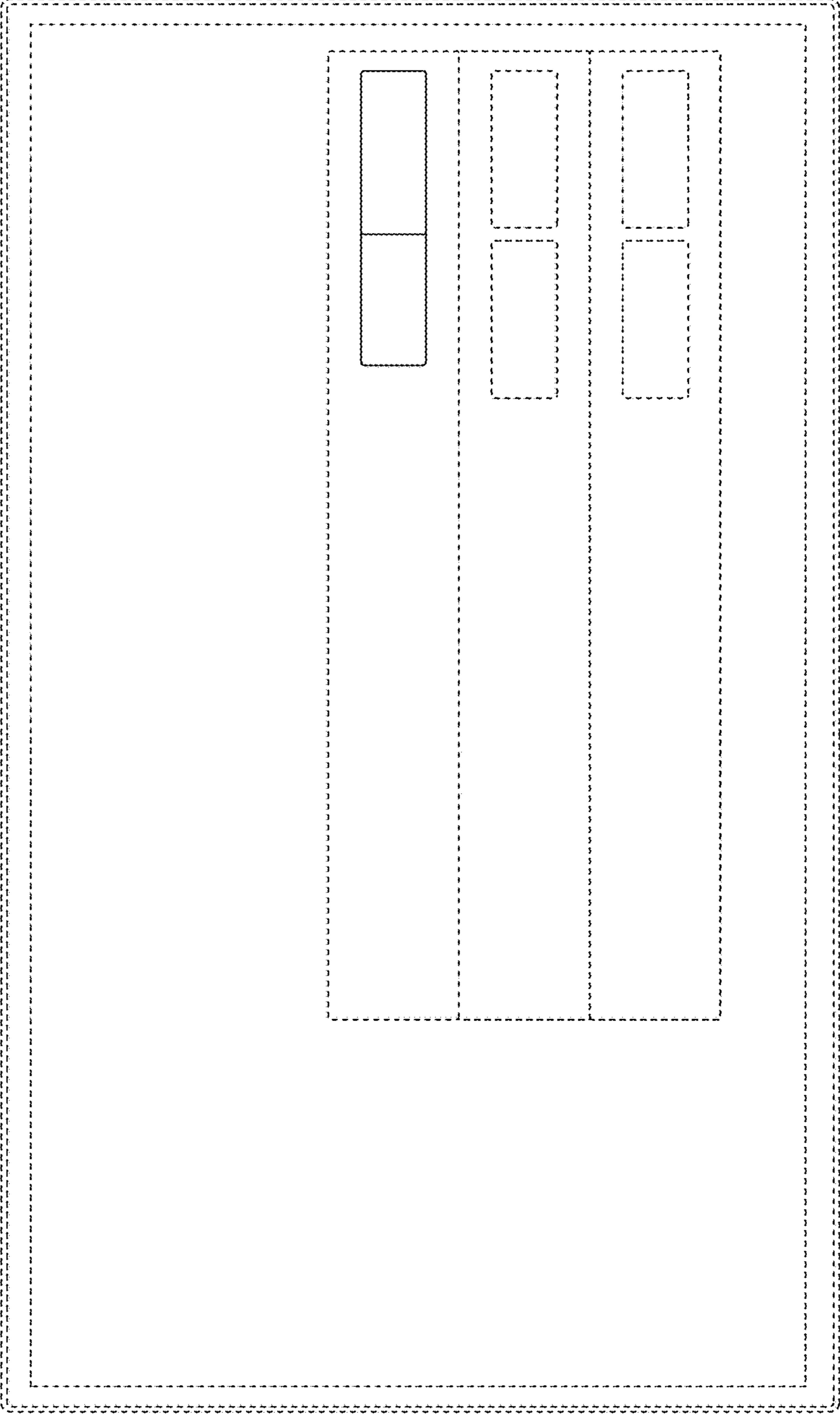

FIG. 11

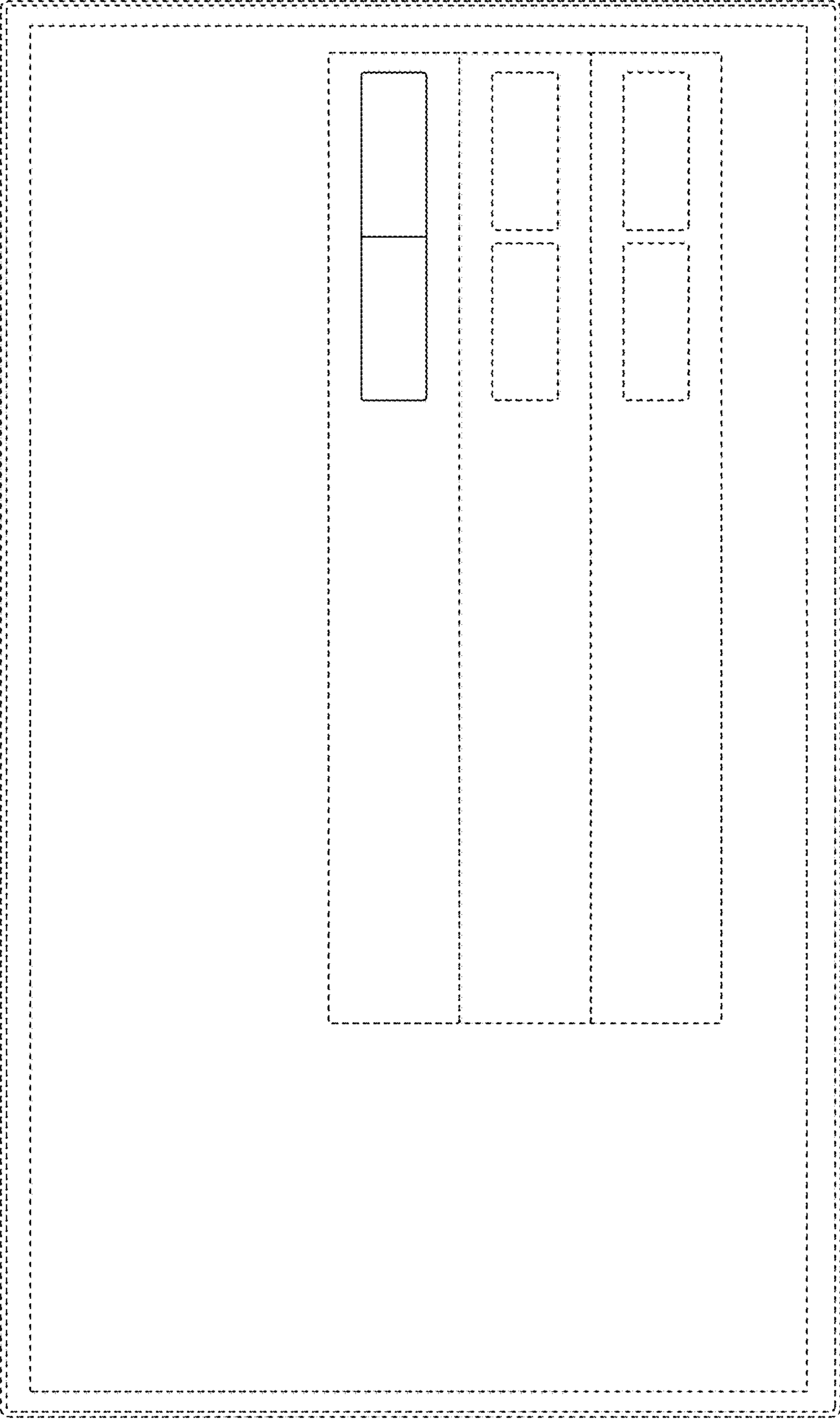

FIG. 12

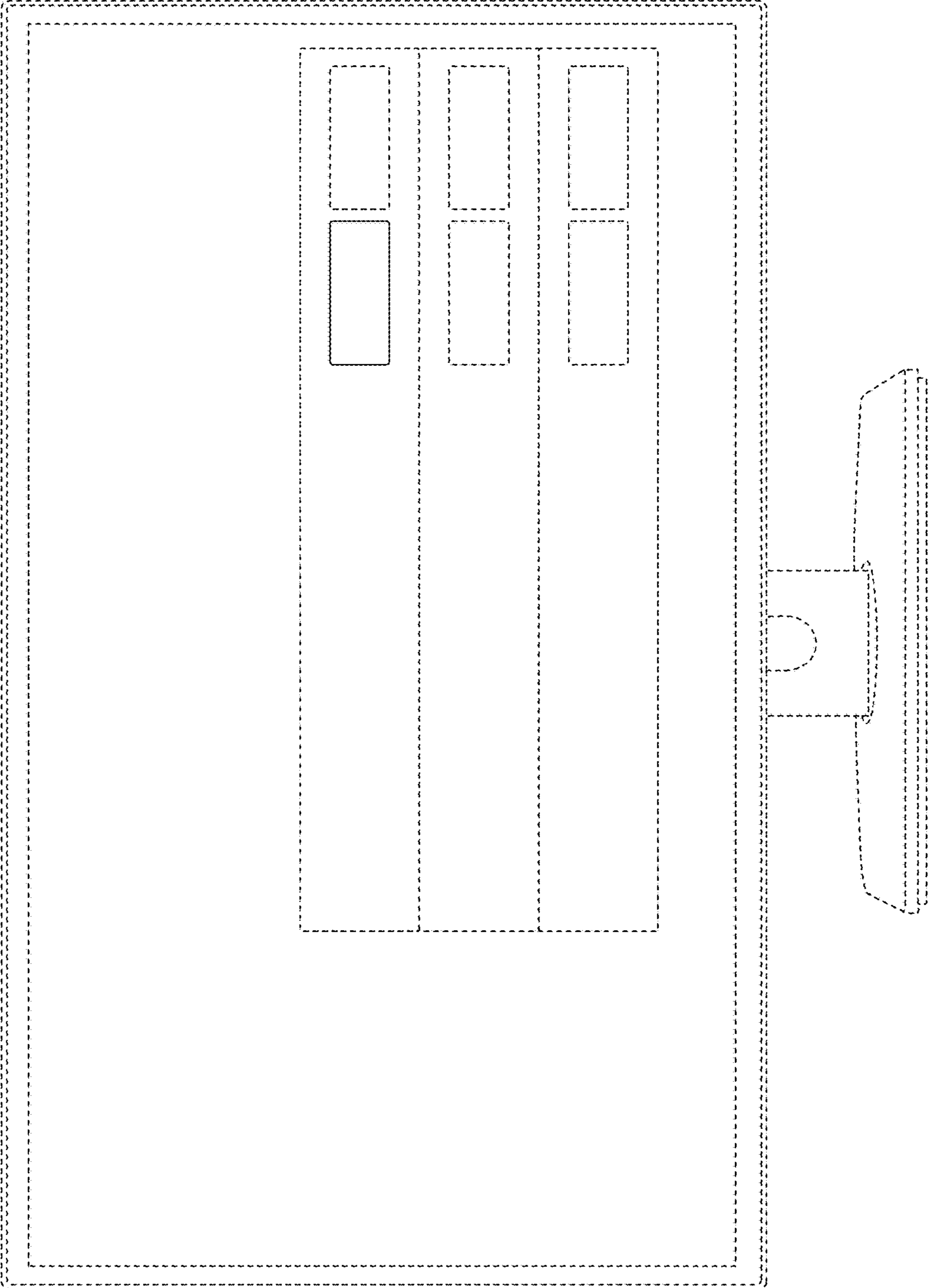

FIG. 13

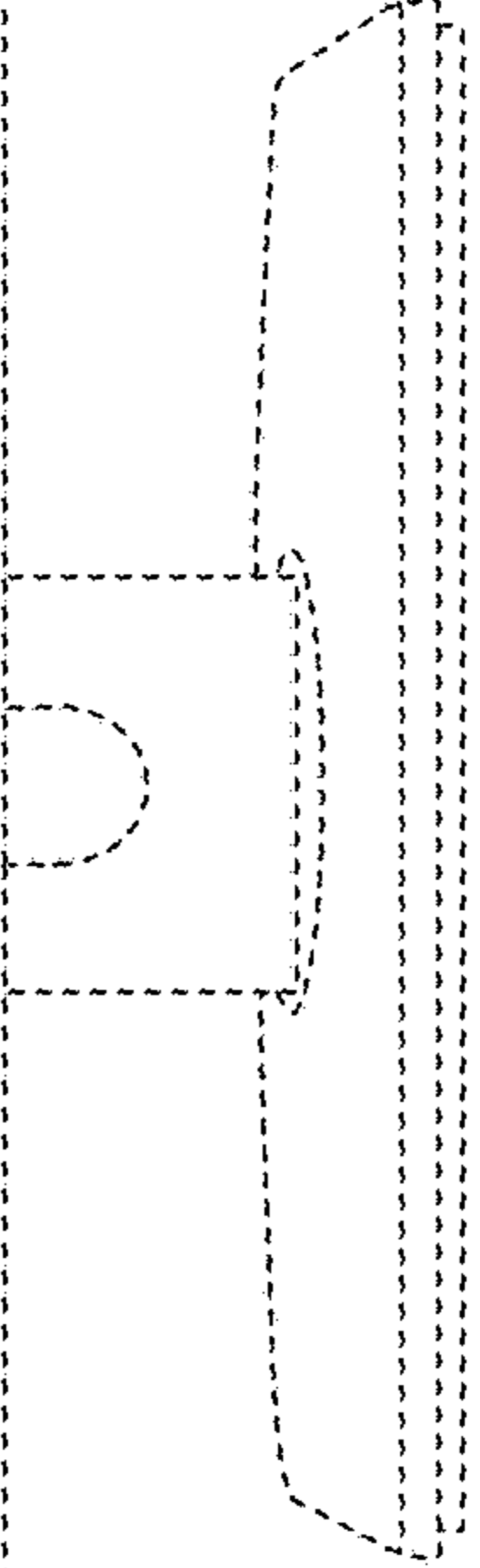
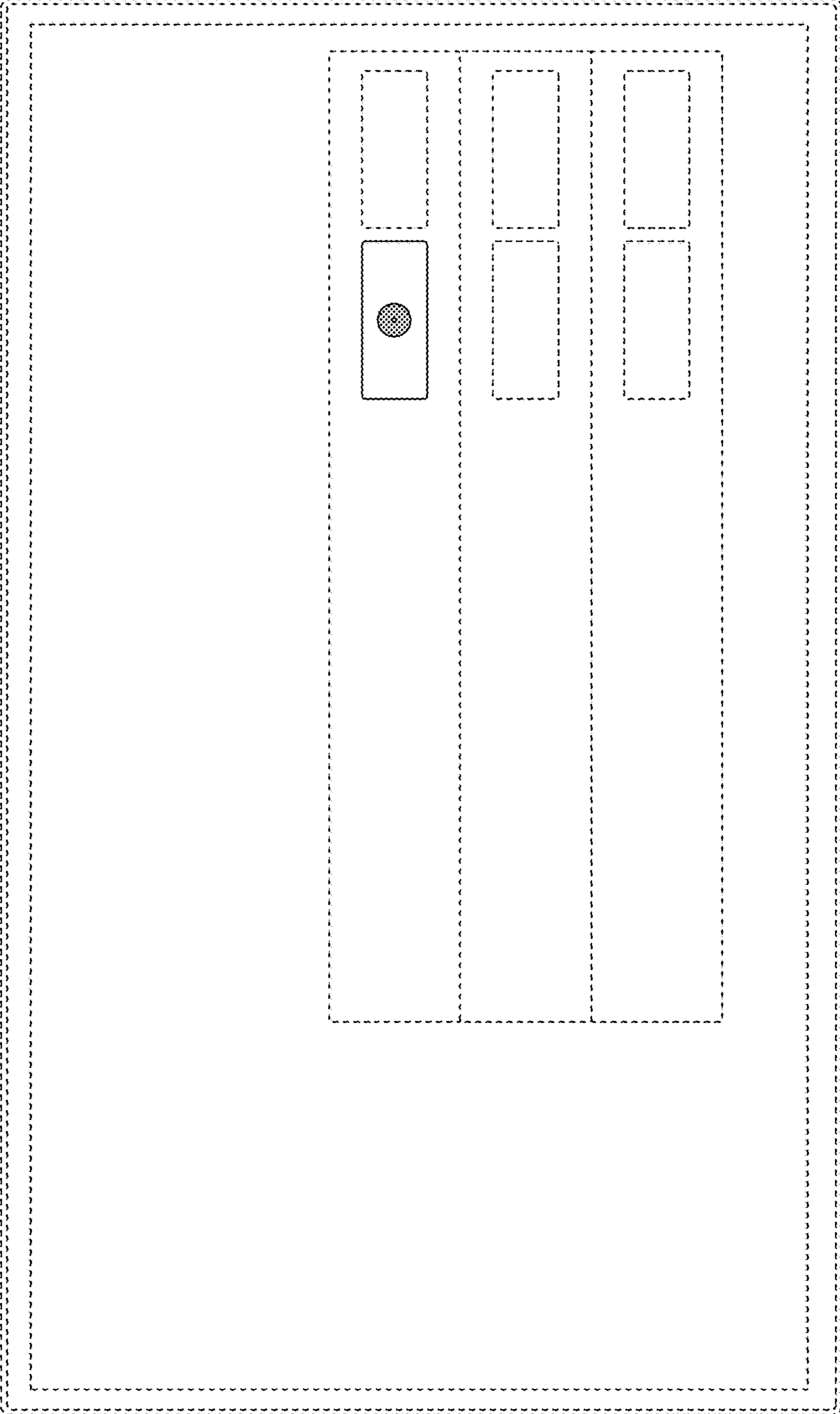
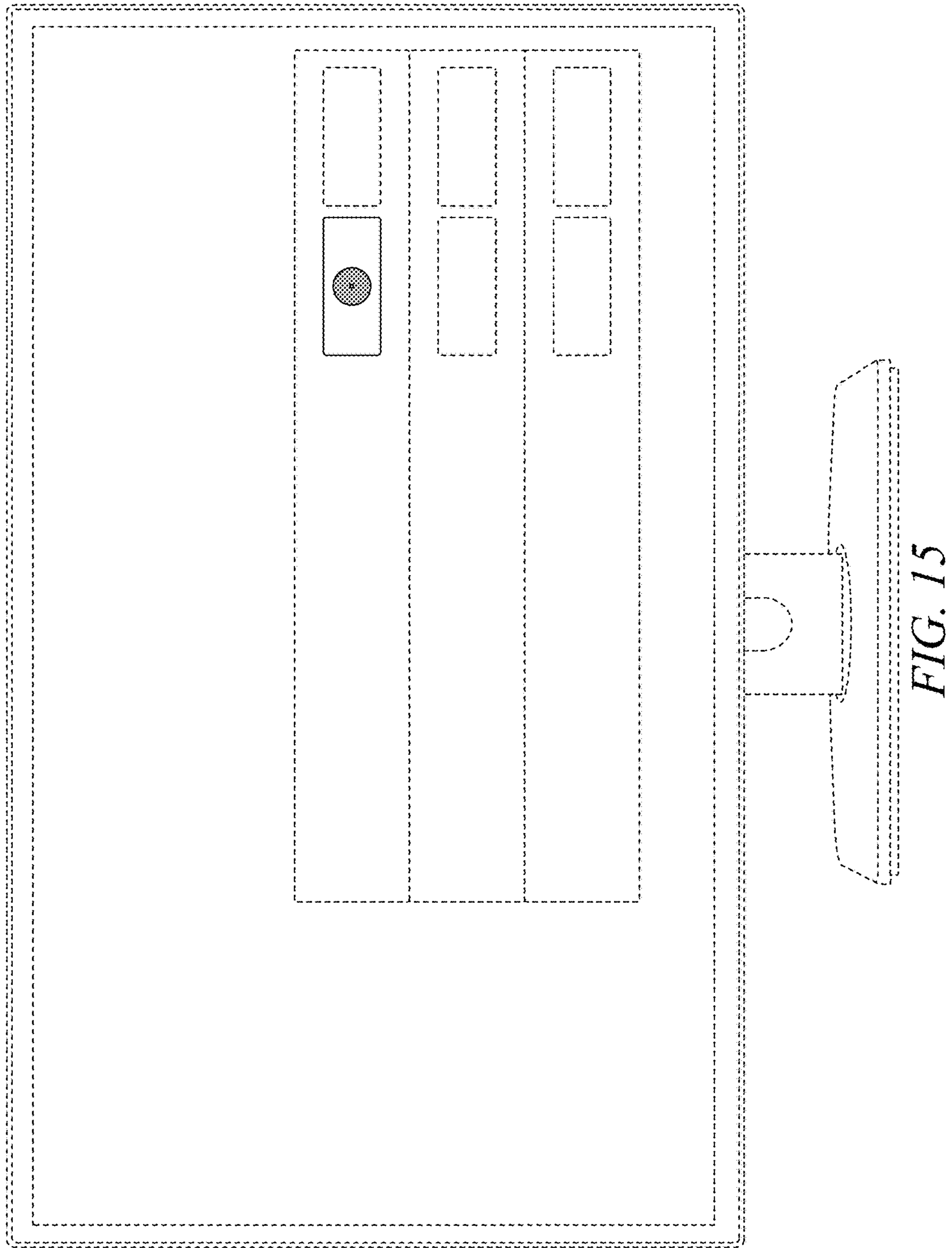

FIG. 14



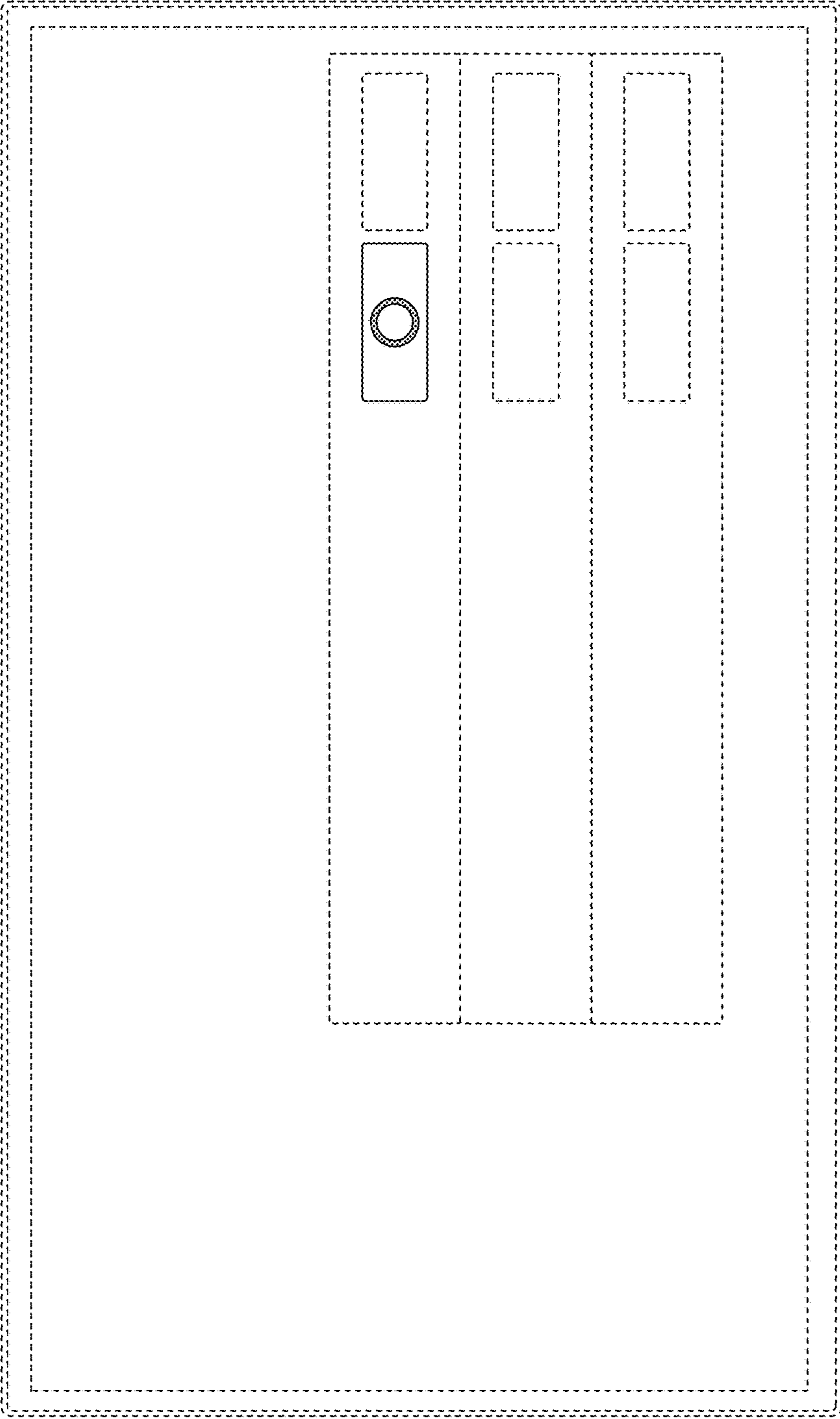

FIG. 16

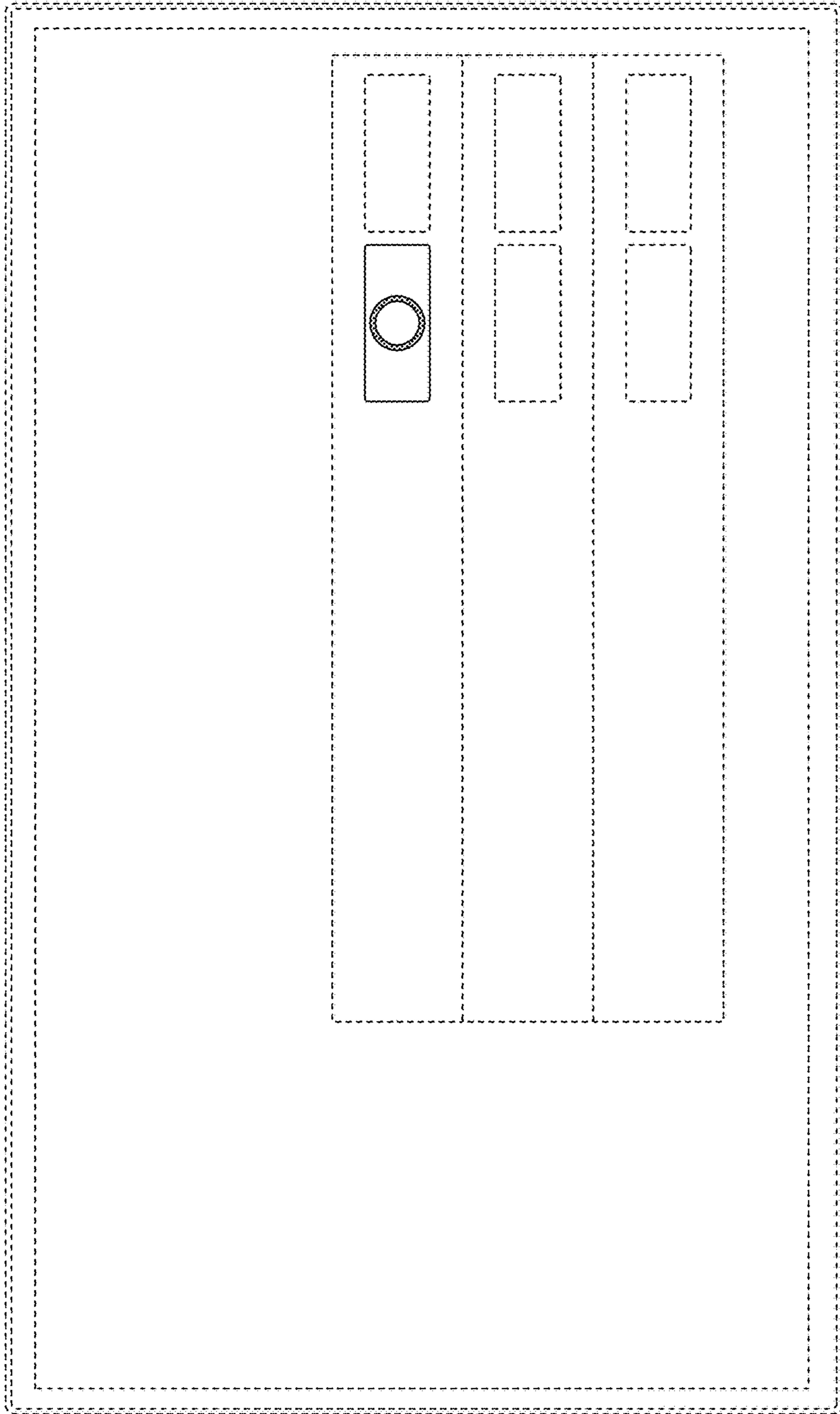
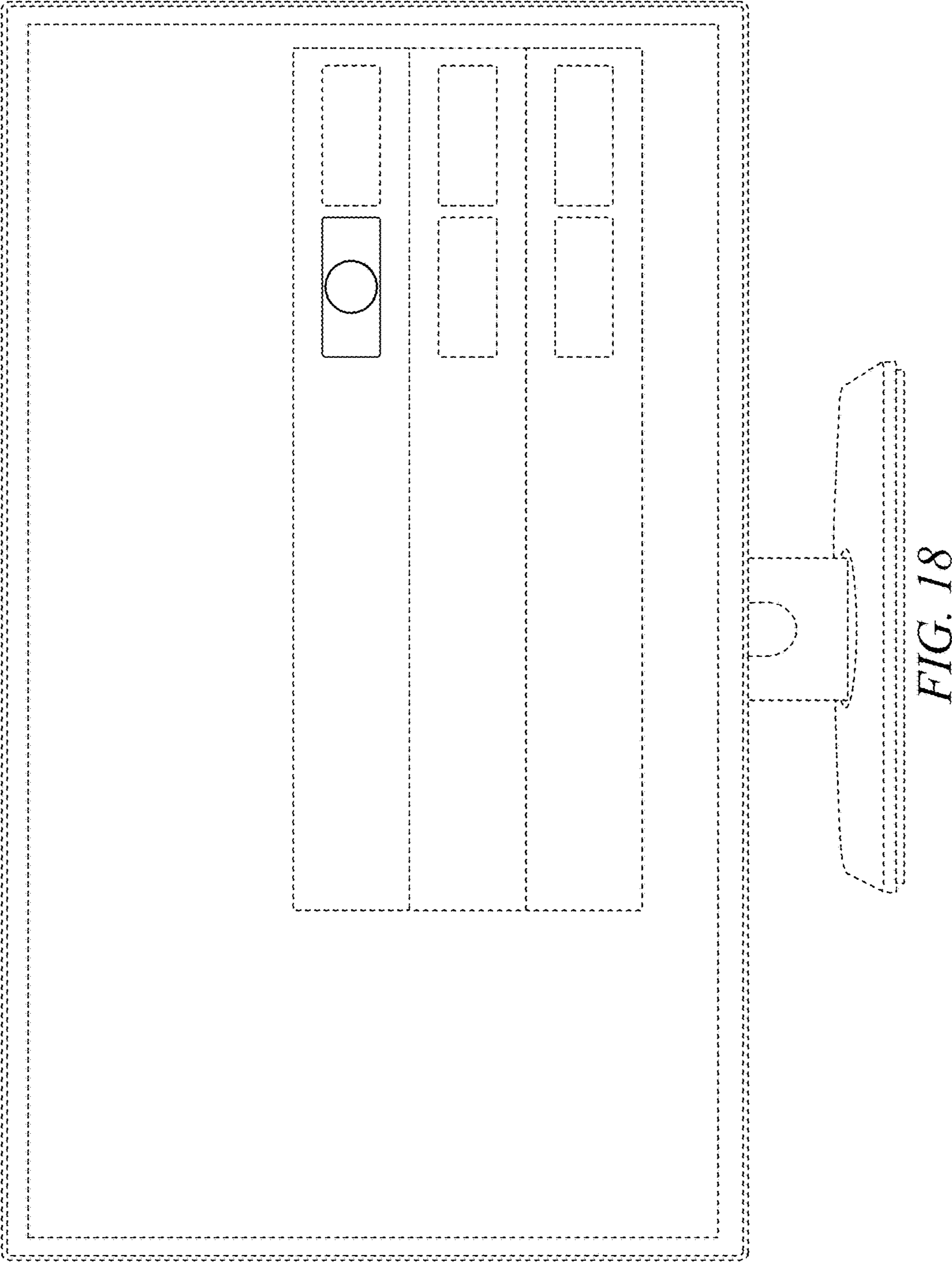
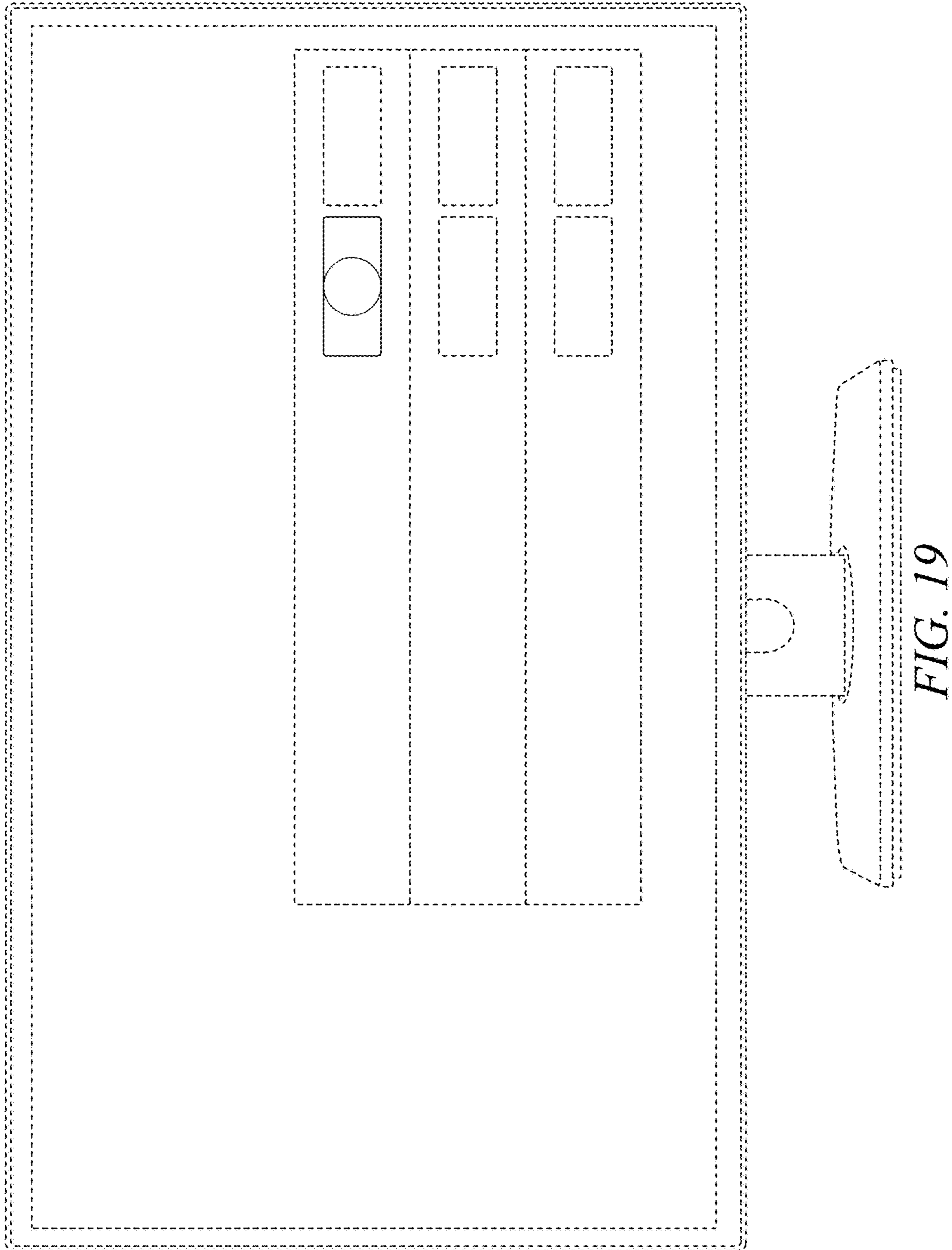

FIG. 17





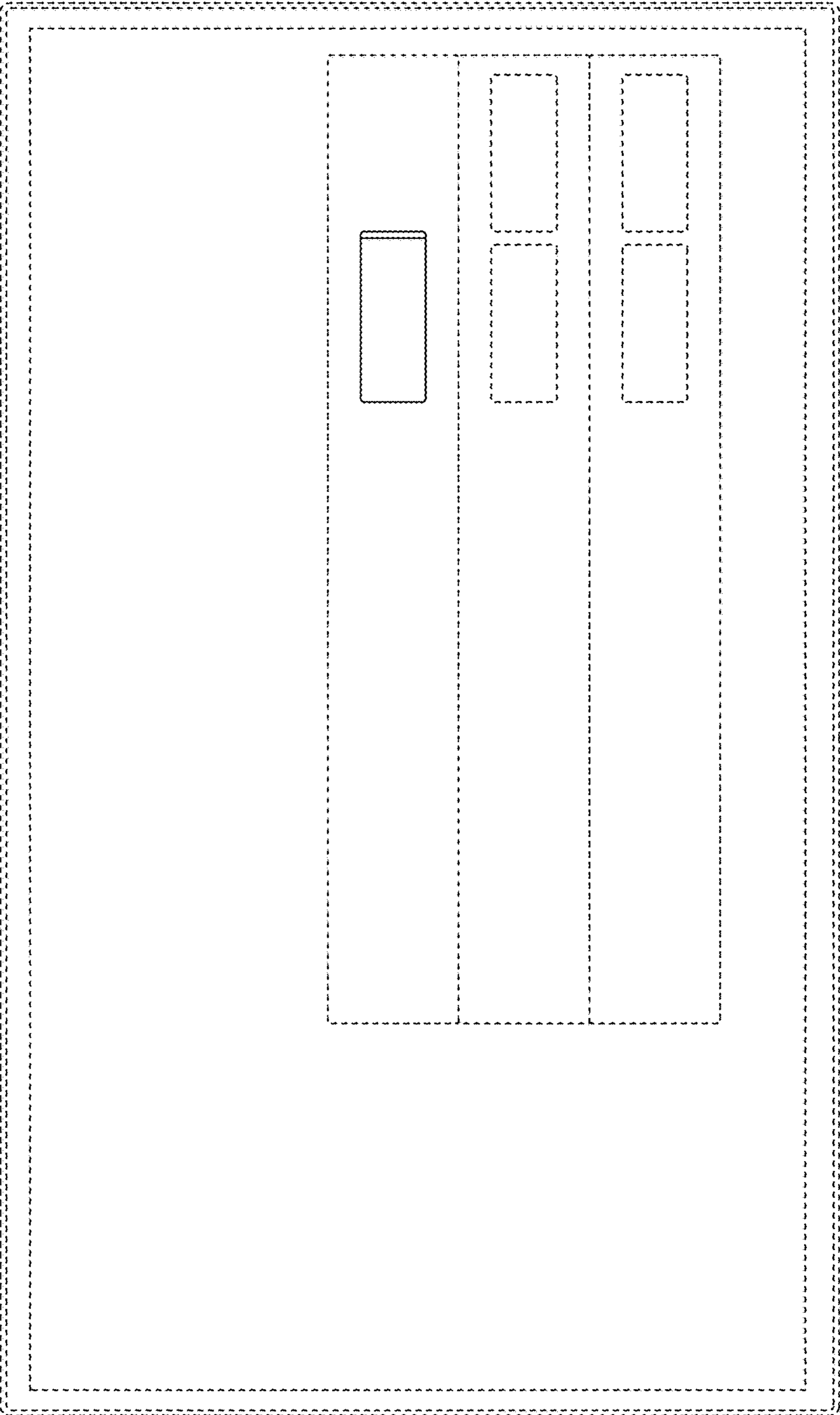

FIG. 20

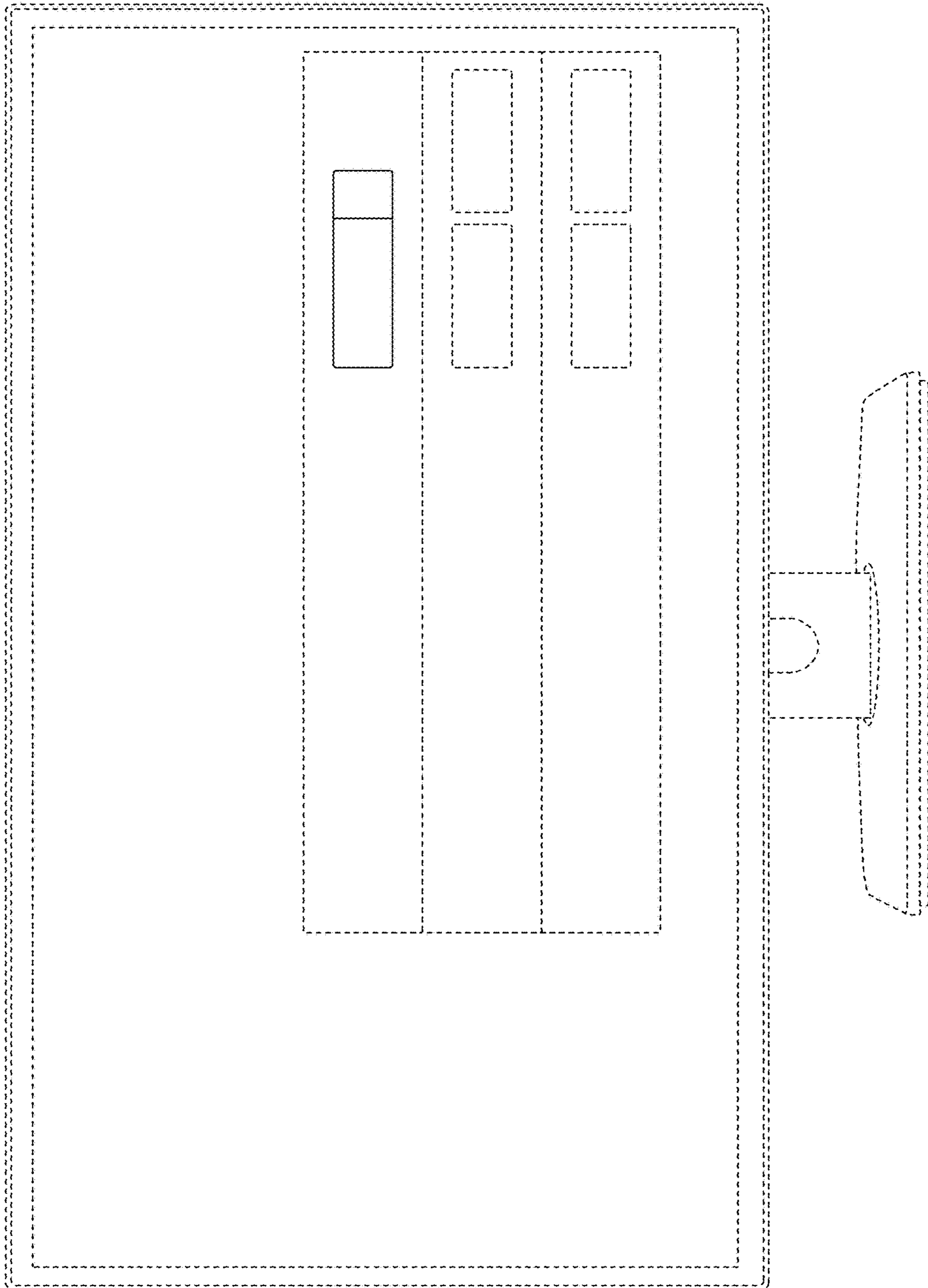
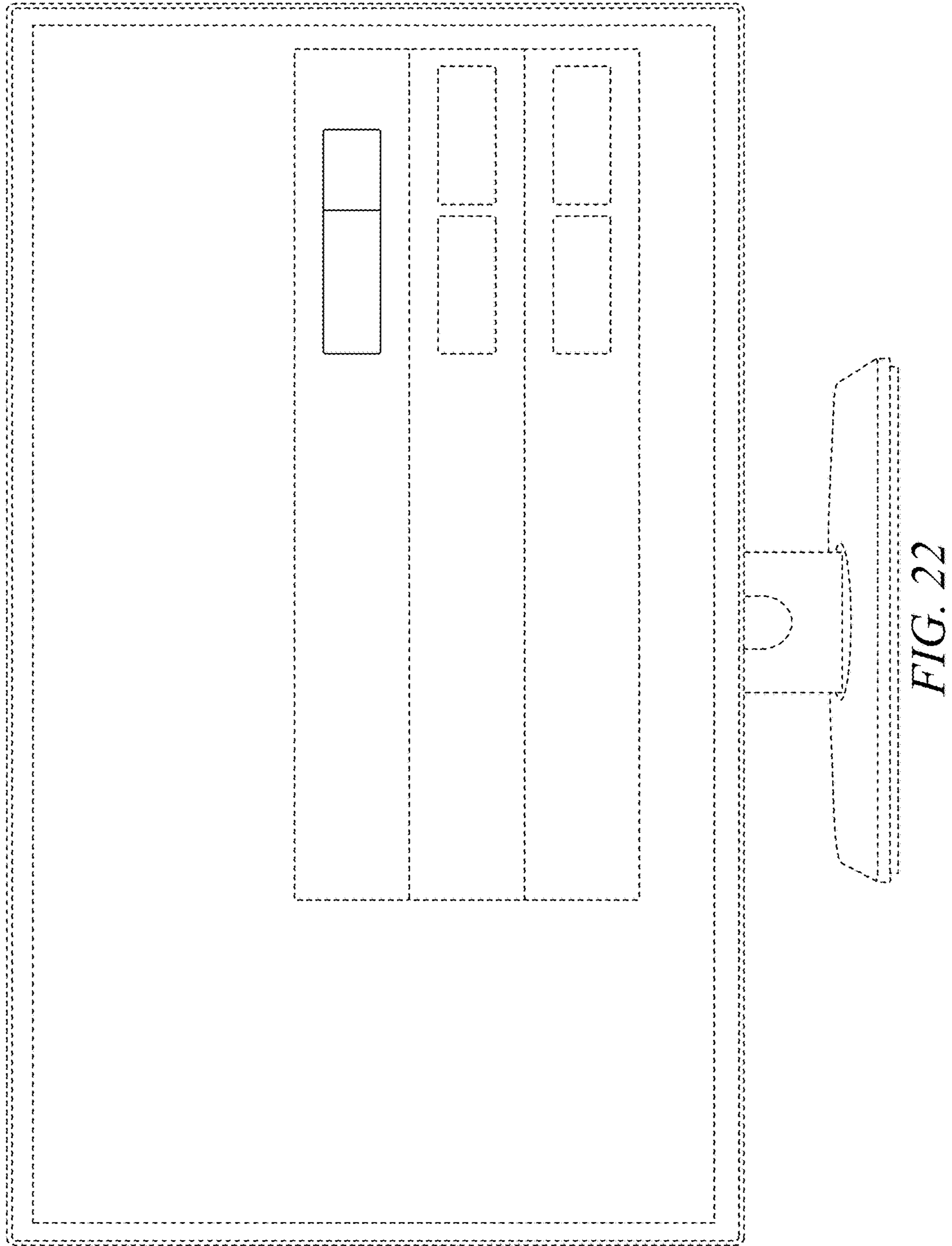

FIG. 21



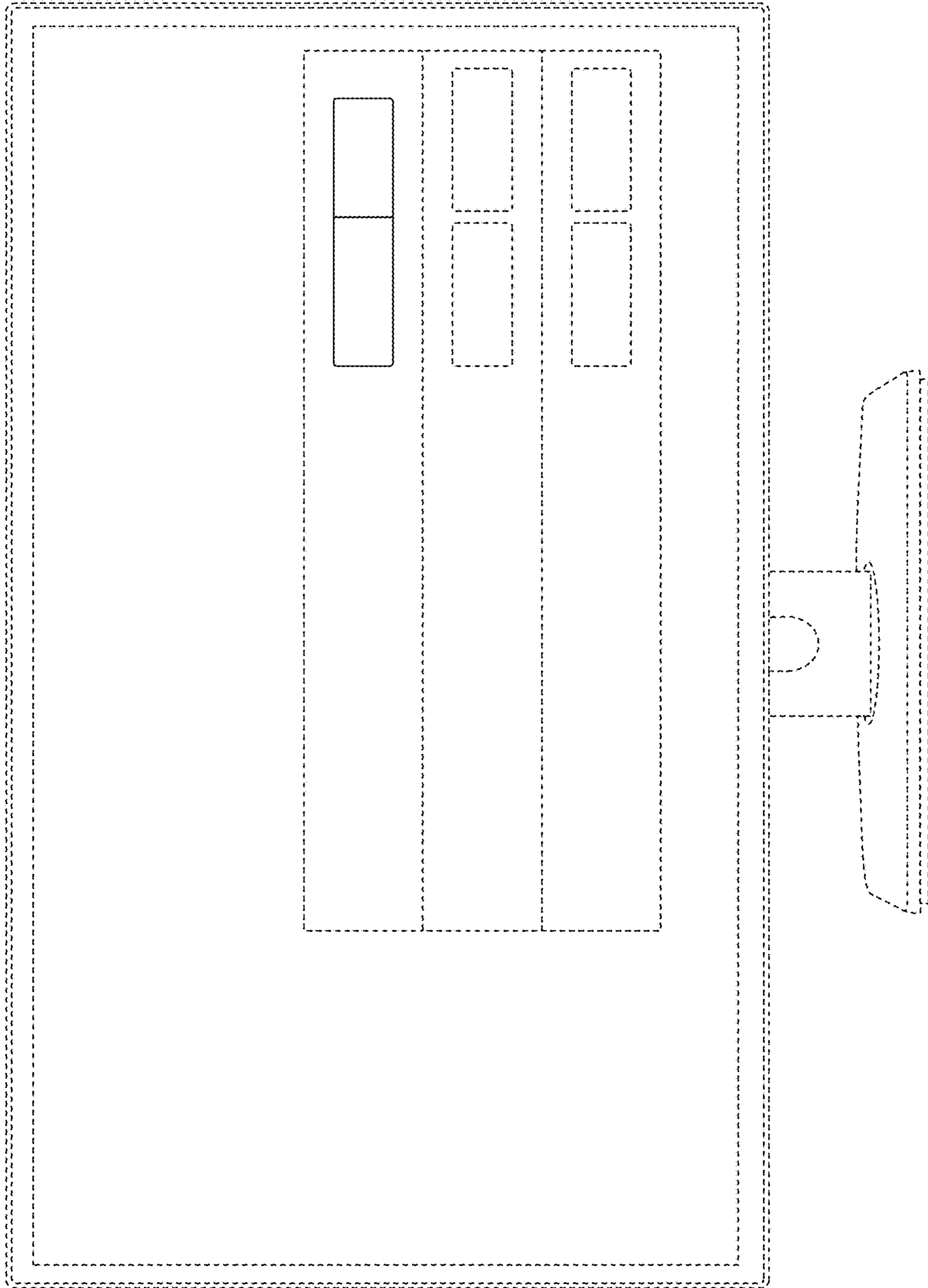

FIG. 23

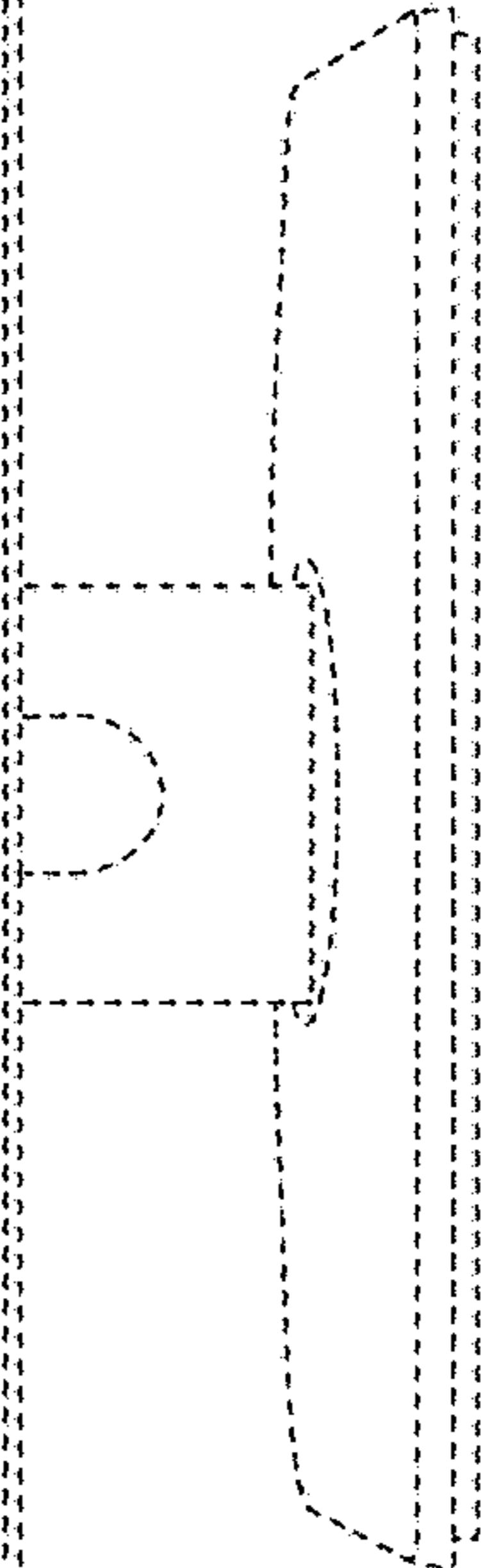
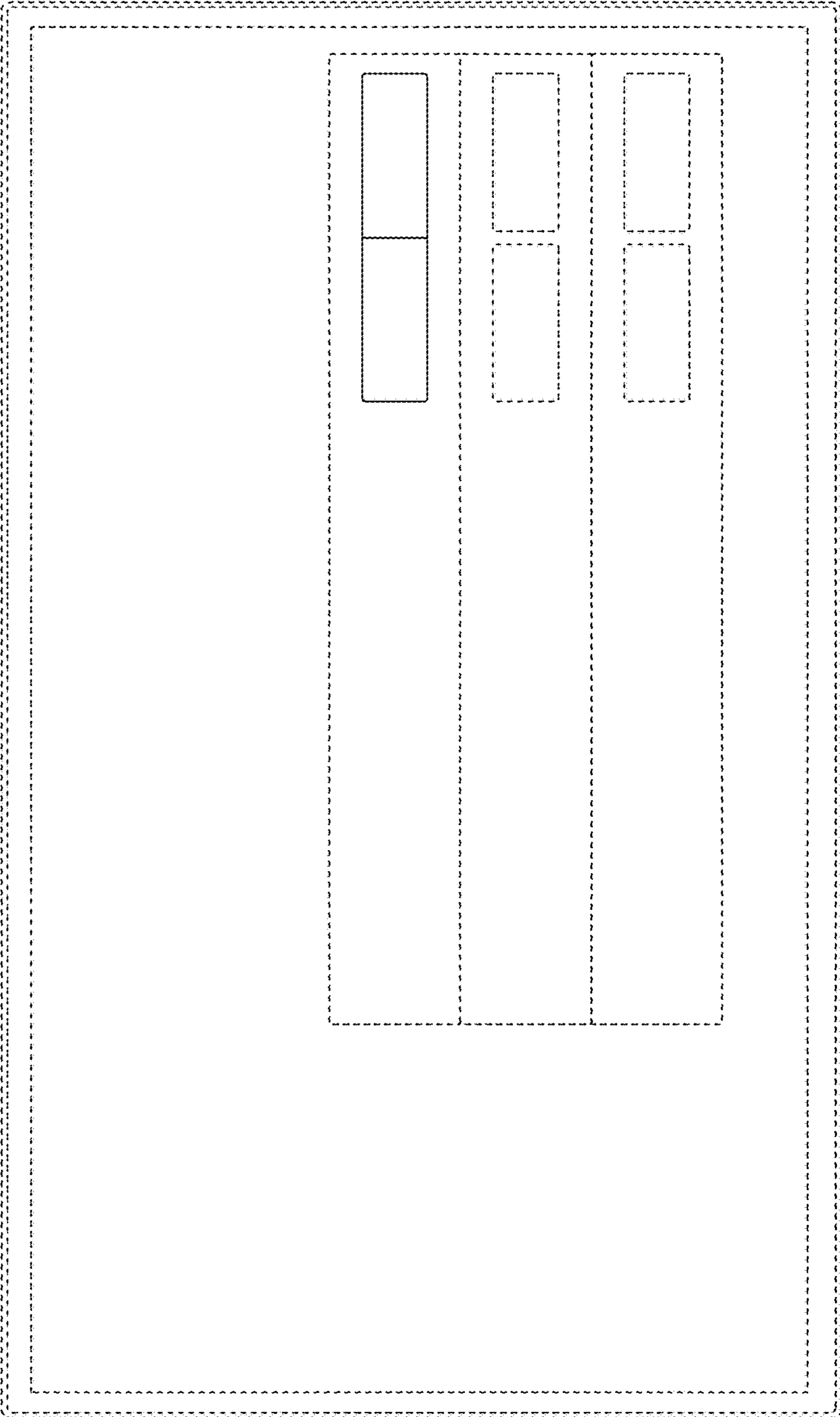

FIG. 24