

US00D836096S

(12) **United States Design Patent** (10) **Patent No.:** **US D836,096 S**
Altschul et al. (45) **Date of Patent:** **** *Dec. 18, 2018**

(54) **POCKET CASE FOR MOBILE COMMUNICATIONS DEVICES COMBINED WITH CARRYING COMPARTMENT FOR CREDIT CARD SIZED ITEMS**

(71) Applicants: **Matthew Altschul**, Austin, TX (US);
Michael J. Martin, Portland, OR (US);
Beejan Soheili, Chula Vista, CA (US)

(72) Inventors: **Matthew Altschul**, Austin, TX (US);
Michael J. Martin, Portland, OR (US);
Beejan Soheili, Chula Vista, CA (US)

(73) Assignee: **Catalyst Medium Four, Inc.**, Austin, TX (US)

(*) Notice: This patent is subject to a terminal disclaimer.

(**) Term: **15 Years**

(21) Appl. No.: **29/574,847**

(22) Filed: **Aug. 18, 2016**

(51) **LOC (11) Cl.** **14-03**

(52) **U.S. Cl.**
USPC **D14/250**

(58) **Field of Classification Search**
USPC D14/143, 189, 203.2–203.7, 217, 238.1,
D14/240, 248, 250–253, 440, 447, 496;
(Continued)

(56) **References Cited**

U.S. PATENT DOCUMENTS

D410,769 S * 6/1999 Dorizas D3/201
D589,699 S * 4/2009 Silvera D3/218
(Continued)

OTHER PUBLICATIONS

iPhone SE/5s/5 Wallet Case, posted at amazon.com, earliest date reviewed Dec. 2, 2012, [online], acquired on Sep. 13, 2017.

Available from Internet, <URL:https://www.amazon.com/iPhone-SE-Wallet-Case-Protective/dp/B0090W0F0M/ref=cm_cr_arp_d_product_top?ie=UTF8&th=1>.*

Primary Examiner — Cathron C Brooks

Assistant Examiner — Aula Soroush

(74) *Attorney, Agent, or Firm* — Scheinberg & Associates, P.C.; John B. Kelly

(57) **CLAIM**

We claim the ornamental design for a pocket case for mobile communications devices with carrying compartment for credit card sized items, as shown and described.

DESCRIPTION

FIG. 1 is a back plan view of a pocket case for mobile communications devices with carrying compartment for credit card sized items.

FIG. 2 is a front plan view thereof.

FIG. 3 is a back perspective view thereof.

FIG. 4 is a back perspective view thereof, the side being the side opposite of the side shown in FIG. 3.

FIG. 5 is a back perspective view thereof.

FIG. 6 is a back perspective view thereof, the side being the side opposite of the side shown in FIG. 5.

FIG. 7 is a side elevation view thereof.

FIG. 8 is side elevation view thereof, the side being the side opposite of the side shown in FIG. 7.

FIG. 9 is a bottom elevation view thereof; and,

FIG. 10 is a top elevation view thereof.

The broken lines in the drawings form no part of the claimed design. The broken lines are shown to define the boundaries of the claimed design and to disclose the environment related to the claimed design. The broken lines forming the word “silk” in the back views of FIGS. 1 and 3-6 define boundaries of the claimed design and form no part of the claimed design. The broken lines forming elongated ovals in the side views of FIGS. 3-8 define boundaries of the claimed design and form no part of the claimed design. The broken lines inside the pocket area of the back views of FIGS. 3 and 6 define boundaries of the claimed design and form no part of the claimed design. The remaining broken lines disclose the environment related to the claimed design, specifically elements of a mobile communications device disposed within the claimed design of a pocket case for a mobile

(Continued)

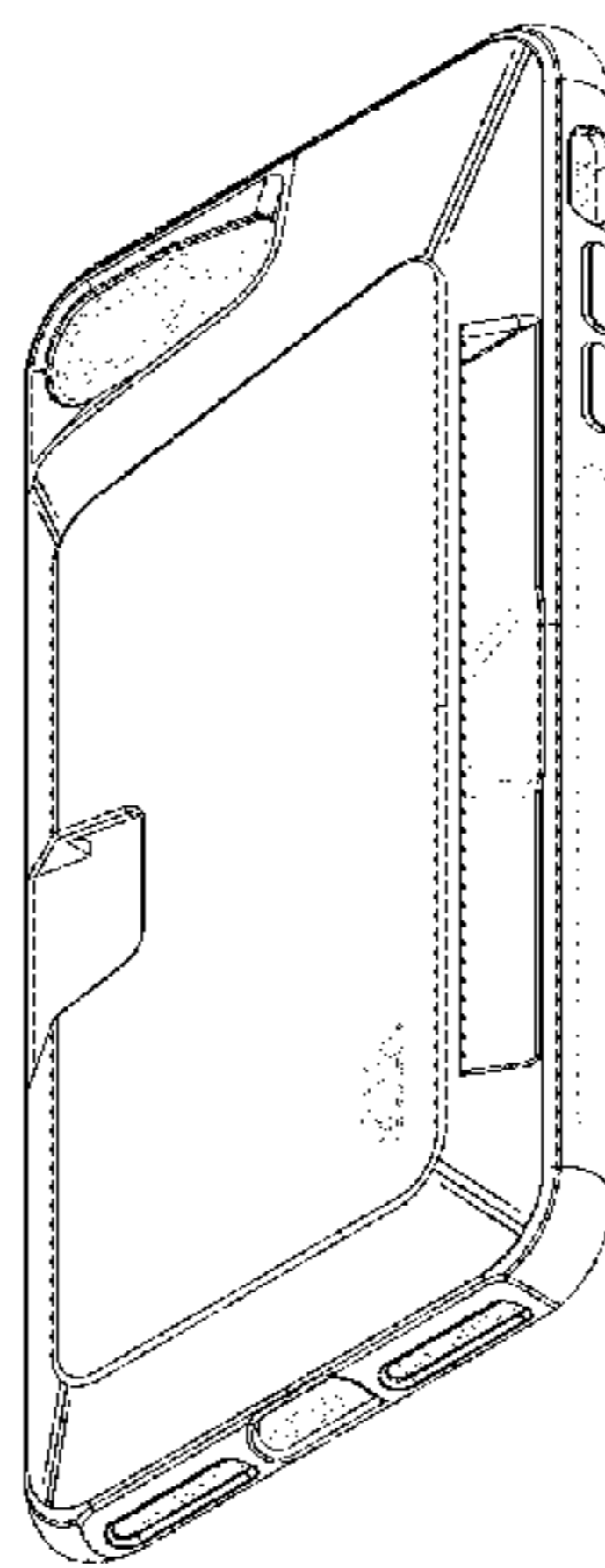

communications device, and form no part of the claimed design.

1 Claim, 8 Drawing Sheets

(58) Field of Classification Search

USPC D3/201, 218, 247-251, 269, 273, 301, D3/303; D13/103, 107-108, 119
CPC A45C 1/06; A45C 11/00; A45C 13/02; A45C 2011/002; A45F 2005/026; A45F 2200/0525; A45F 2200/0516; H04B 1/3888; H04M 1/0283; H04M 1/0202
See application file for complete search history.

(56) References Cited

U.S. PATENT DOCUMENTS

D590,151 S * 4/2009 Karobkina D3/247
D637,591 S * 5/2011 Willes D14/250

8,504,127 B2 * 8/2013 Altschul H04M 1/0283
206/216
D694,009 S * 11/2013 D'Amore D3/249
D697,716 S * 1/2014 Owen D3/303
D706,536 S * 6/2014 Nikosey D3/247
D707,965 S * 7/2014 Requa D3/247
D714,058 S * 9/2014 Owen D3/247
D719,950 S * 12/2014 Smith D14/250
D721,689 S * 1/2015 Altschul H04M 1/0283
D14/250
D726,171 S * 4/2015 Edwards D14/250
D759,966 S * 6/2016 Pignotti D3/247
D772,212 S * 11/2016 Daniel D14/250
D793,379 S * 8/2017 Zhang D14/250
2012/0067751 A1 * 3/2012 Mongan A45C 11/00
206/216

* cited by examiner

FIG. 1

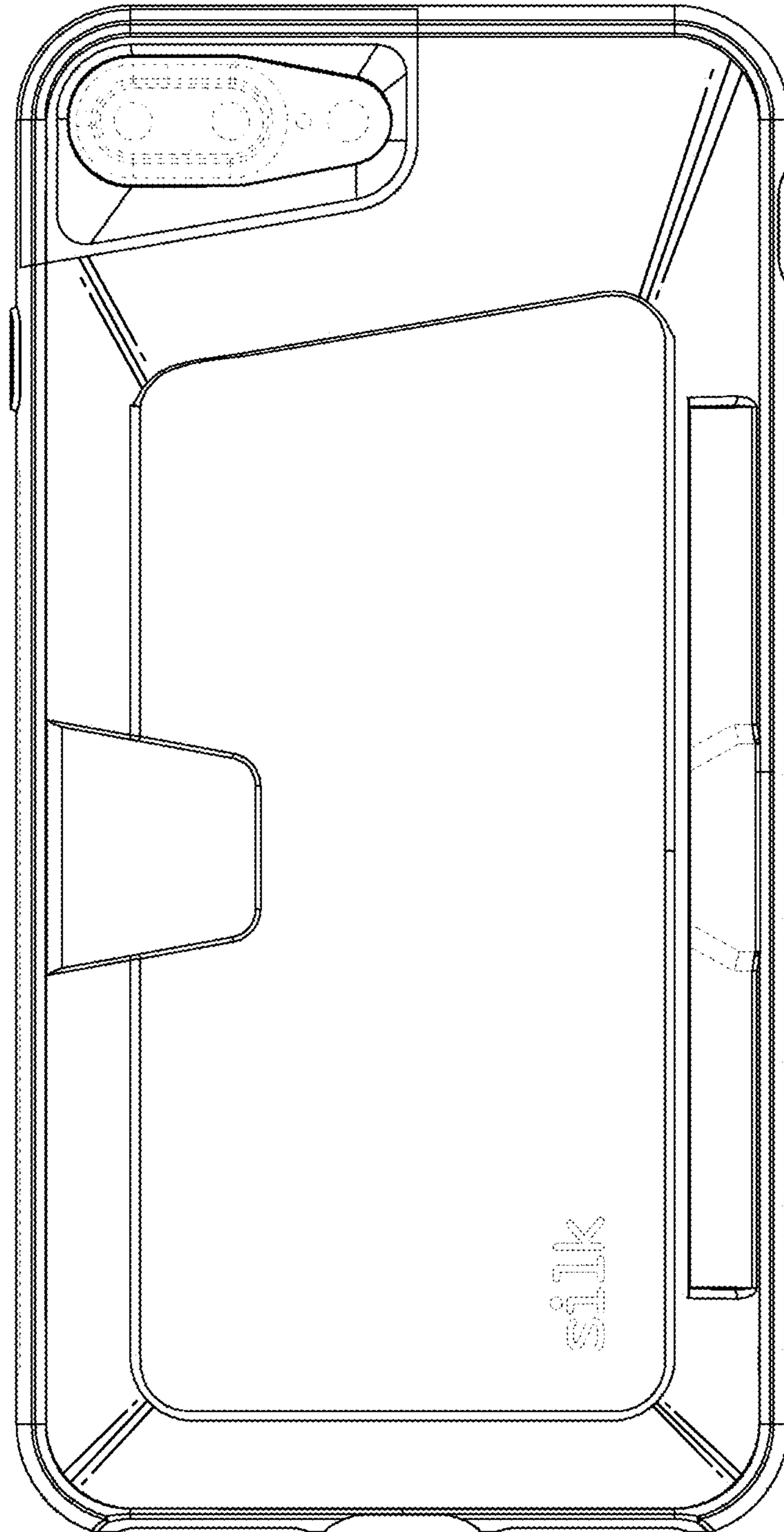

FIG. 2

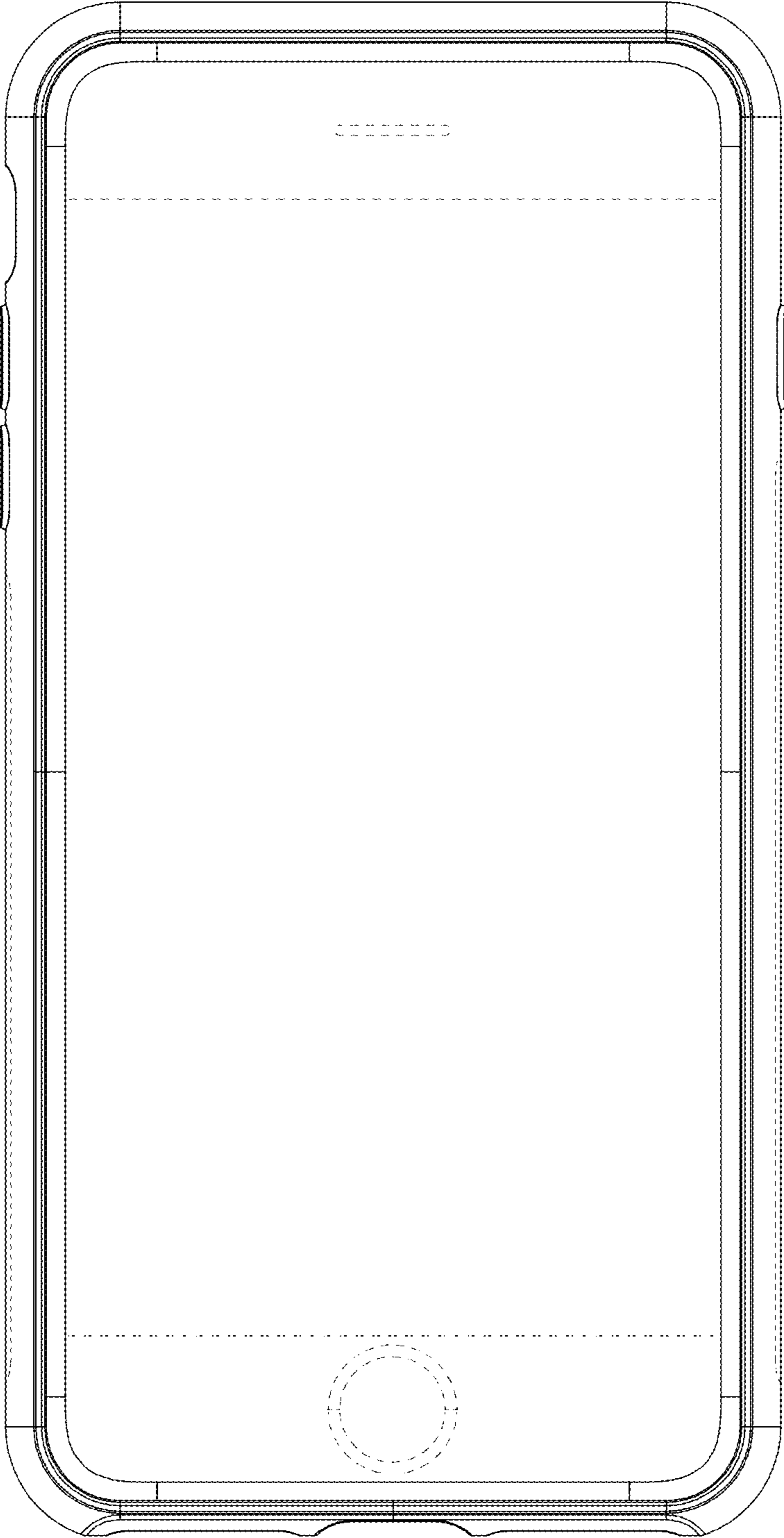

FIG. 3

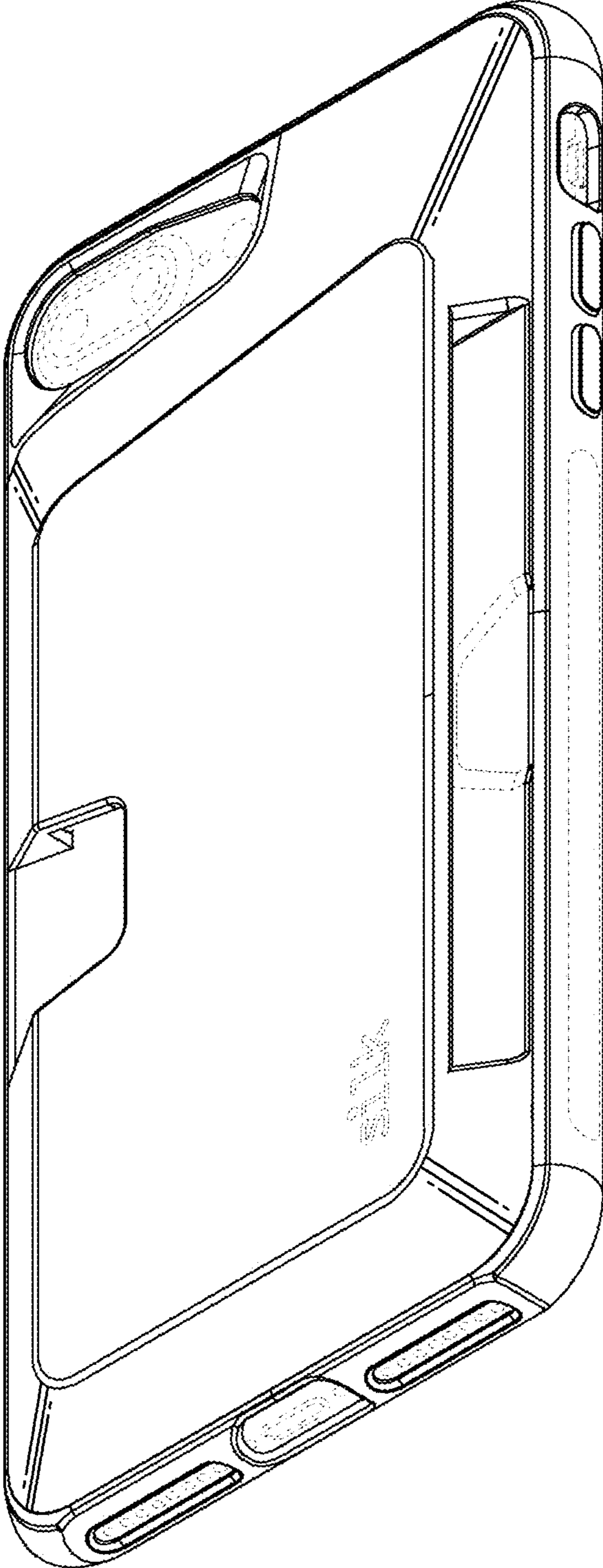

FIG. 4

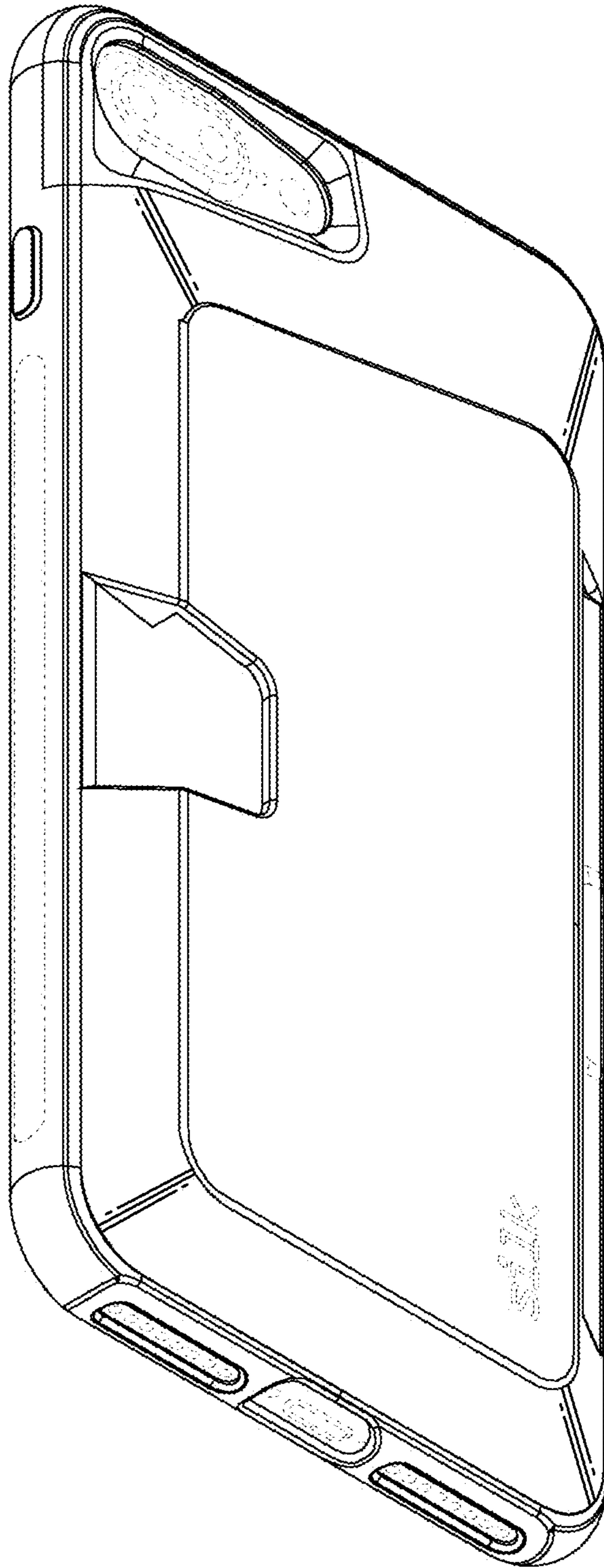

FIG. 5

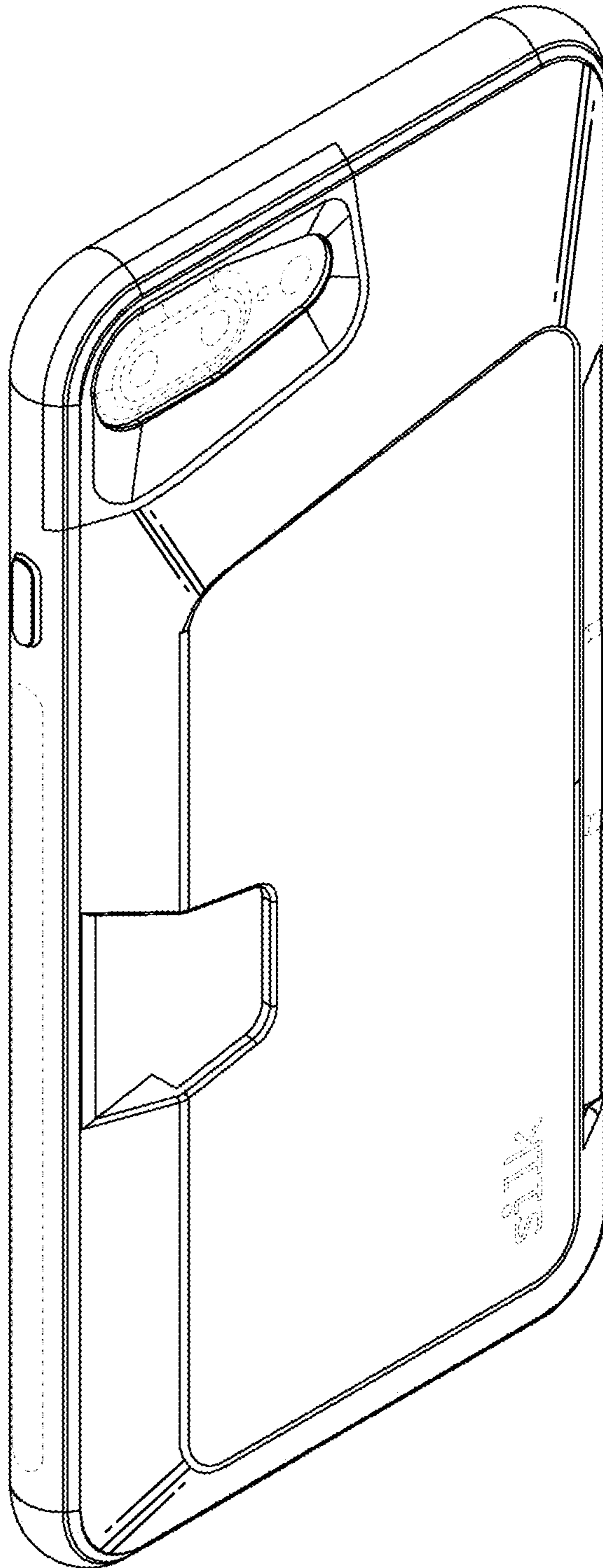
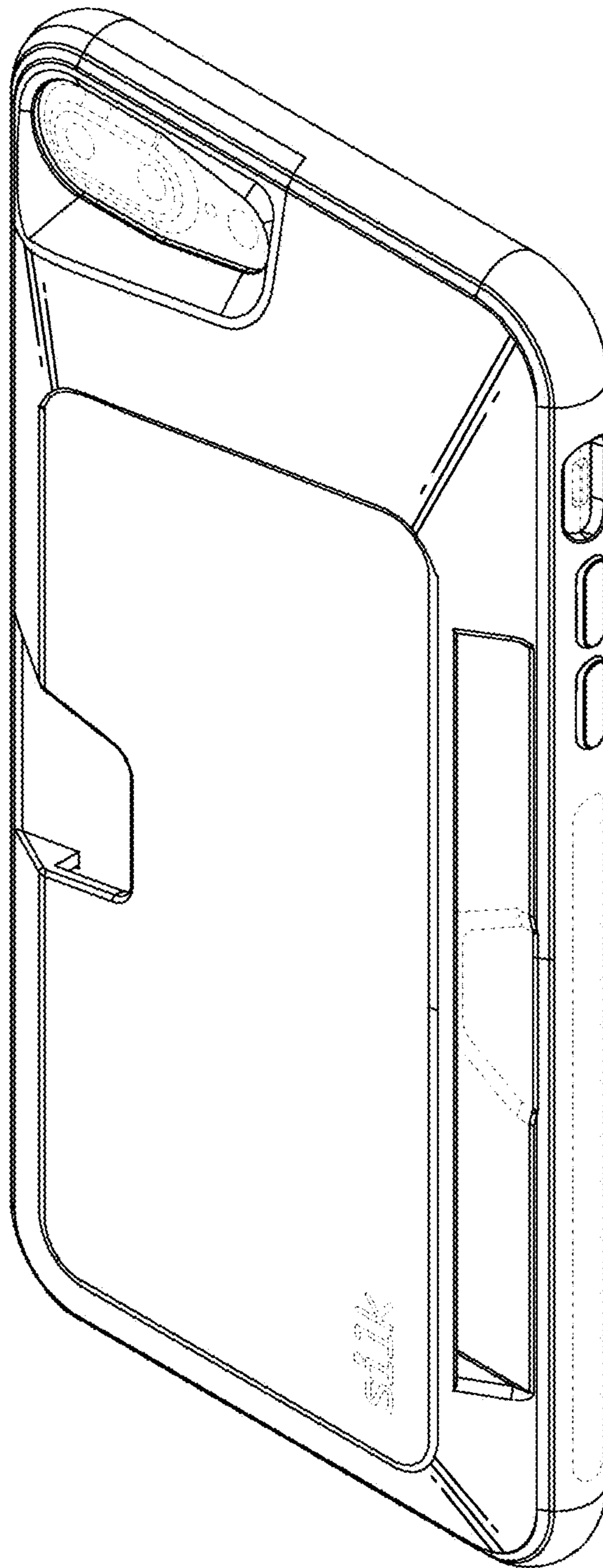

FIG. 6



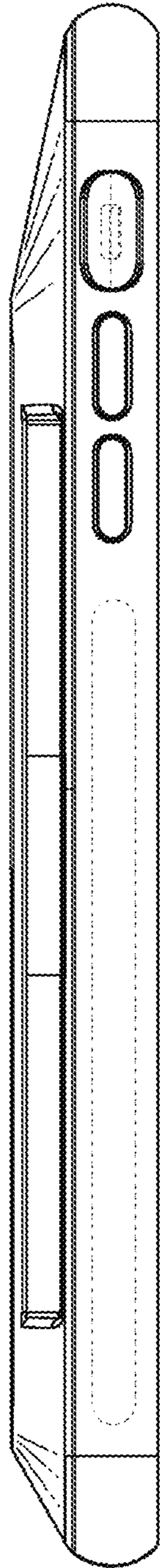

FIG. 7

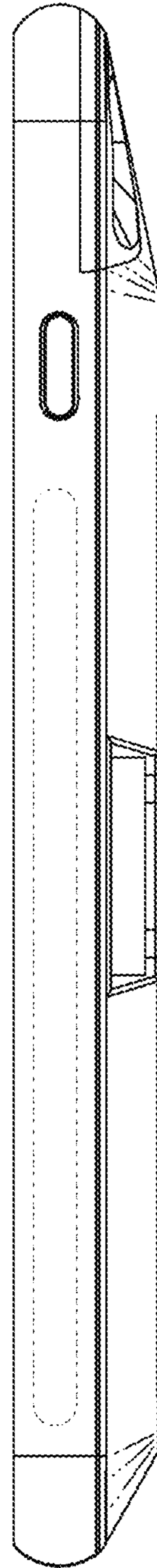

FIG. 8

FIG. 9

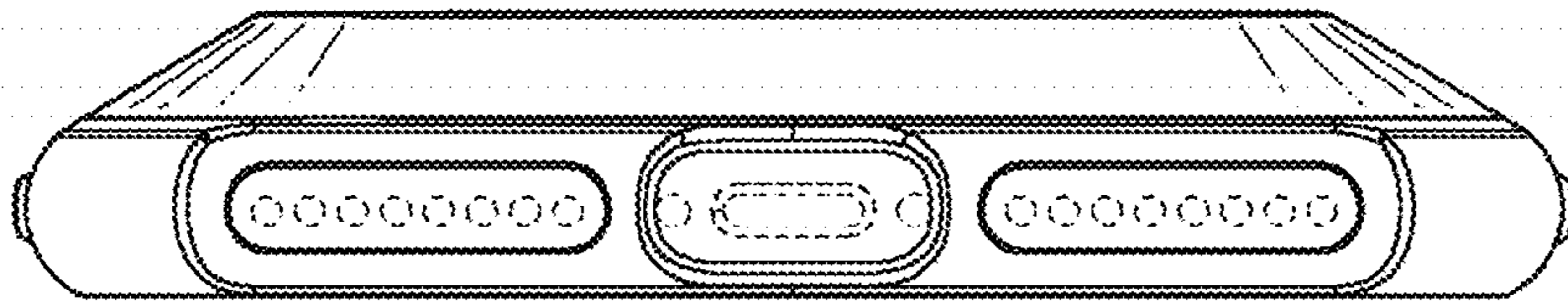

FIG. 10

