



US00D836038S

(12) **United States Design Patent**
Huang

(10) **Patent No.:** **US D836,038 S**

(45) **Date of Patent:** **** Dec. 18, 2018**

(54) **ELECTRIC BIKE**

(71) Applicant: **Beijing Menluo Electrocar Co. Ltd.,**
Beijing (CN)

(72) Inventor: **Yang Huang,** Beijing (CN)

(73) Assignee: **BEIJING MENLUO ELECTROCAR**
CO. LTD., Beijing (CN)

(**) Term: **15 Years**

(21) Appl. No.: **29/589,402**

(22) Filed: **Dec. 30, 2016**

(51) **LOC (11) Cl.** **12-11**

(52) **U.S. Cl.**
USPC **D12/111**

(58) **Field of Classification Search**
USPC D12/110, 111, 112, 114, 117, 119
CPC ... B62K 3/00; B62K 3/02; B62K 5/00; B62K
5/003; B62K 5/007; B62K 5/01; B62K
11/00; B62K 11/02; B62K 11/04; B62K
15/00; B62K 2202/00; B62J 37/00
See application file for complete search history.

(56) **References Cited**

U.S. PATENT DOCUMENTS

D269,262 S * 6/1983 Kuyama D12/110
D504,360 S * 4/2005 Sramek D12/111
D529,843 S * 10/2006 Pizzi D12/111
D556,642 S * 12/2007 Lu D12/111

D618,596 S * 6/2010 Song D12/110
D619,934 S * 7/2010 Li D12/110
D626,036 S * 10/2010 Yamazumi D12/110
D666,529 S * 9/2012 Renner D12/110
D666,530 S * 9/2012 Birtulescu D12/110
D684,504 S * 6/2013 Renner D12/110
D687,351 S * 8/2013 Carducci D12/110
D691,520 S * 10/2013 Birtulescu D12/110
2007/0125585 A1 * 6/2007 Takahashi B62J 37/00
180/219

* cited by examiner

Primary Examiner — Karen S Acker

Assistant Examiner — Jerry Shiuan-Hua Hsu

(74) *Attorney, Agent, or Firm* — Lucas & Marcanti, LLP

(57) **CLAIM**

The ornamental design for an electric bike, as shown and described.

DESCRIPTION

FIG. 1 is a perspective view of an electric bike showing my new design;

FIG. 2 is an enlarged front view;

FIG. 3 is an enlarged rear view;

FIG. 4 is a top view;

FIG. 5 is a bottom view;

FIG. 6 is a left side view; and,

FIG. 7 is a right side view.

1 Claim, 6 Drawing Sheets

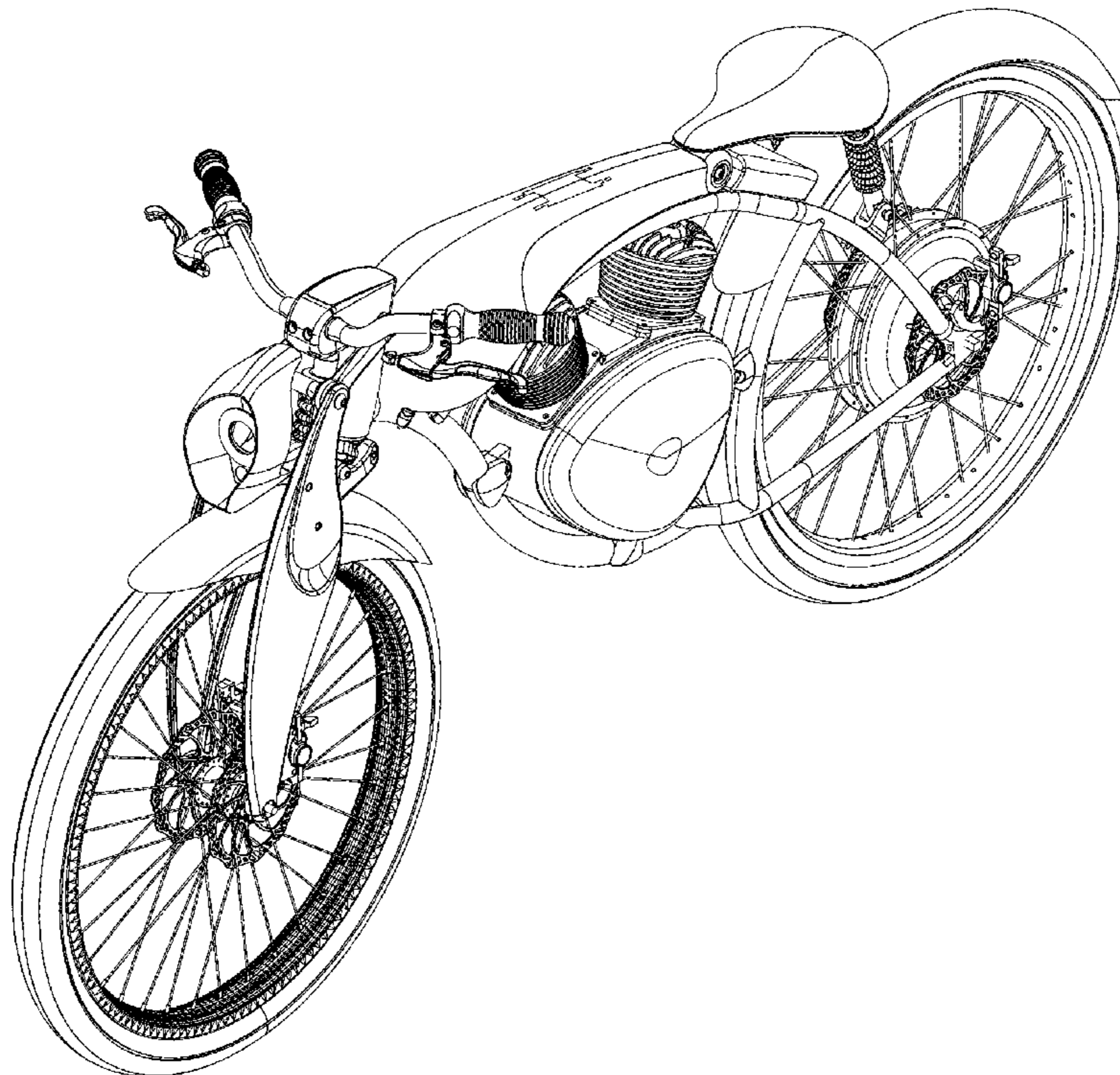

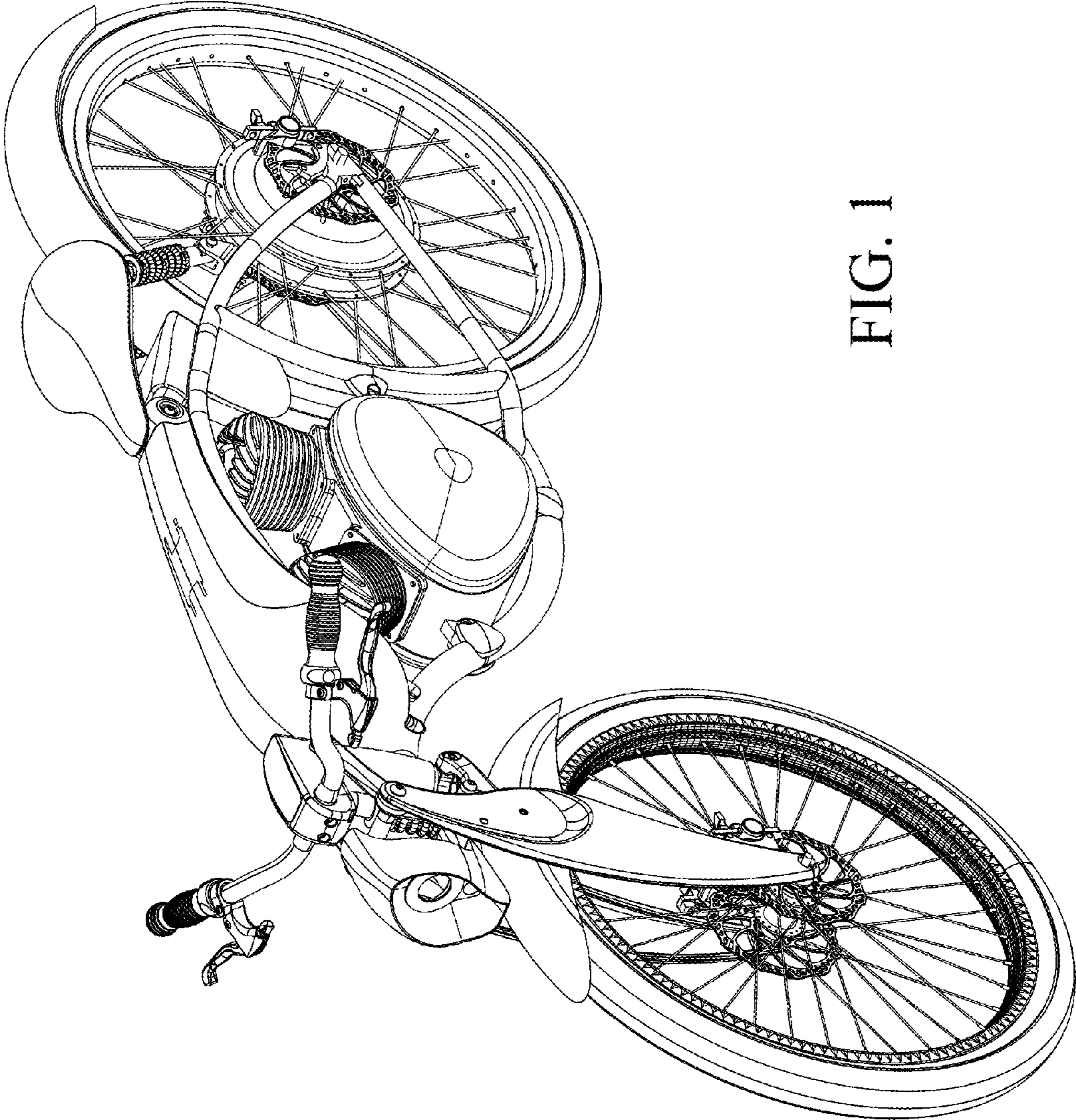

FIG. 1

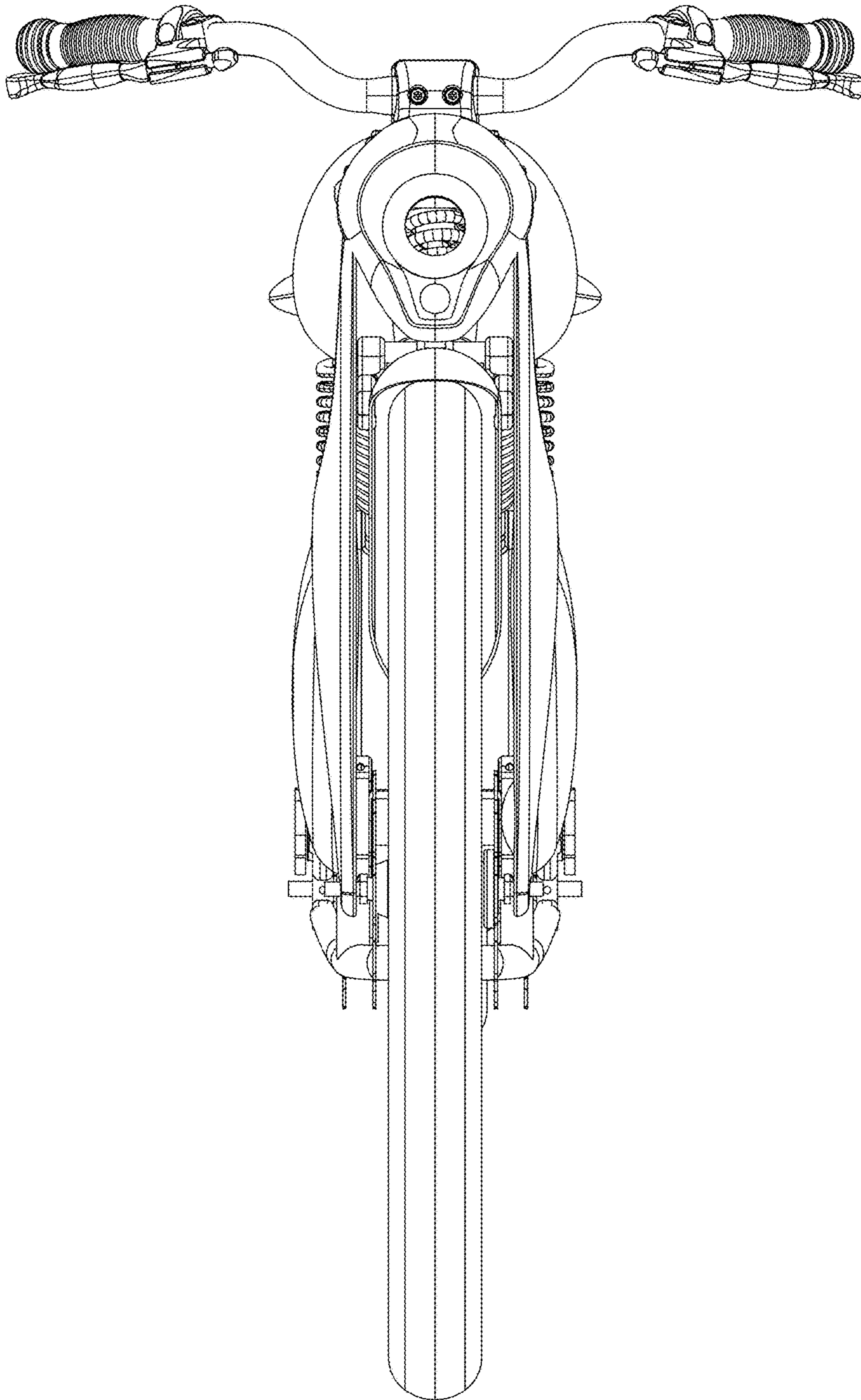

FIG. 2

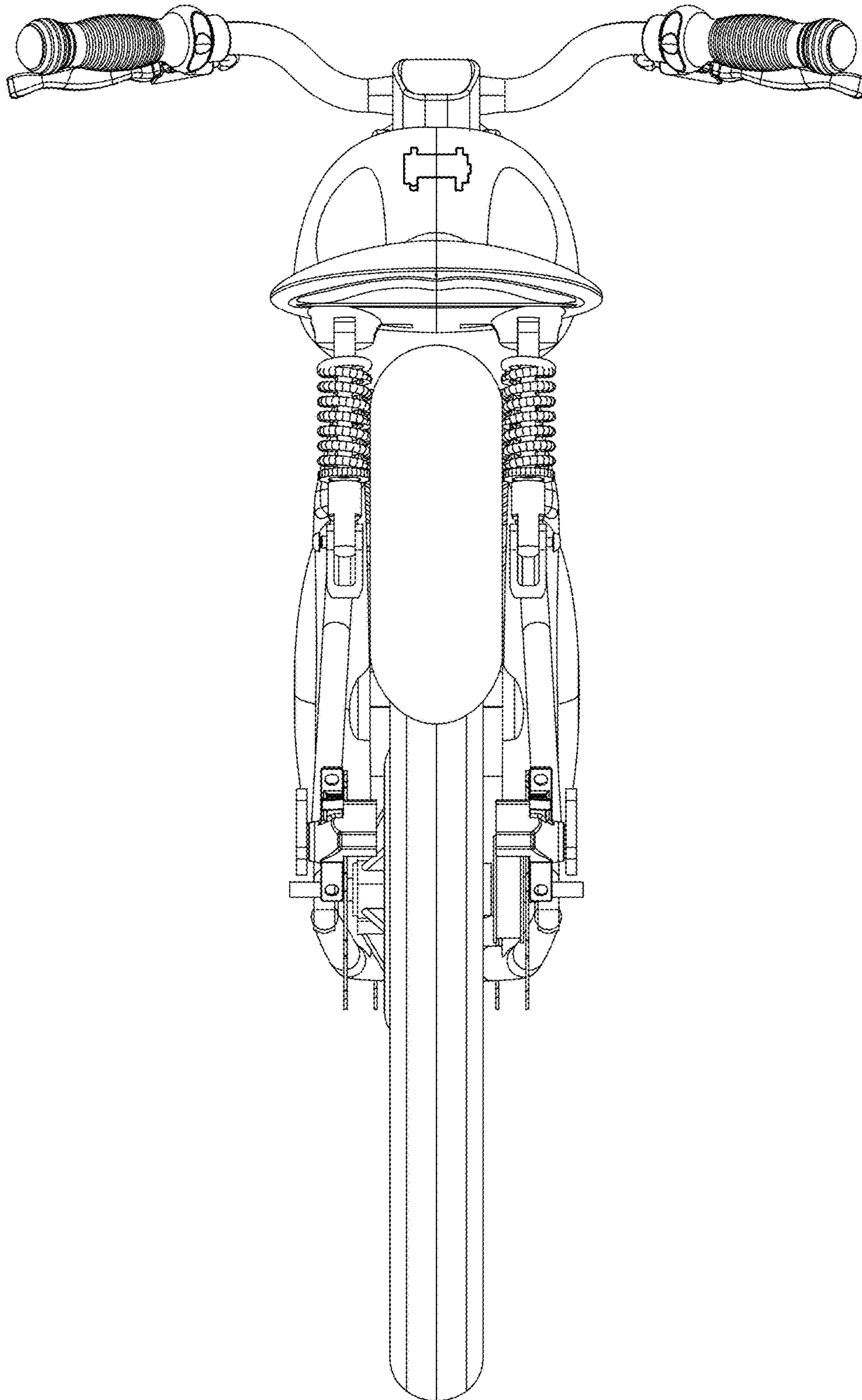

FIG. 3

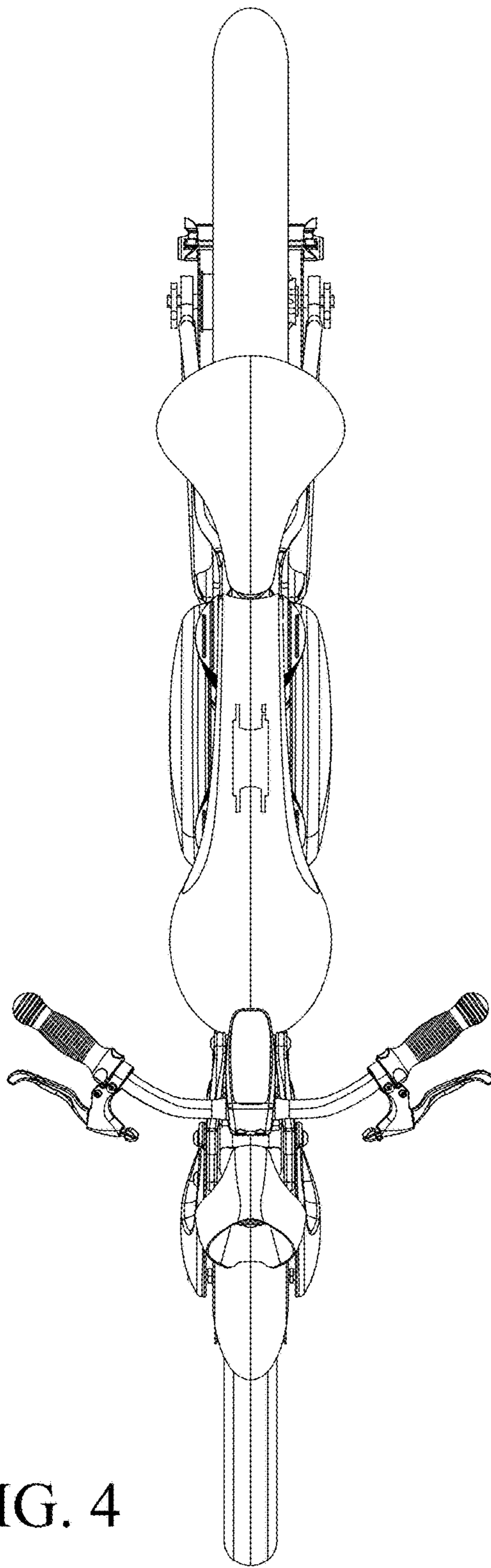

FIG. 4

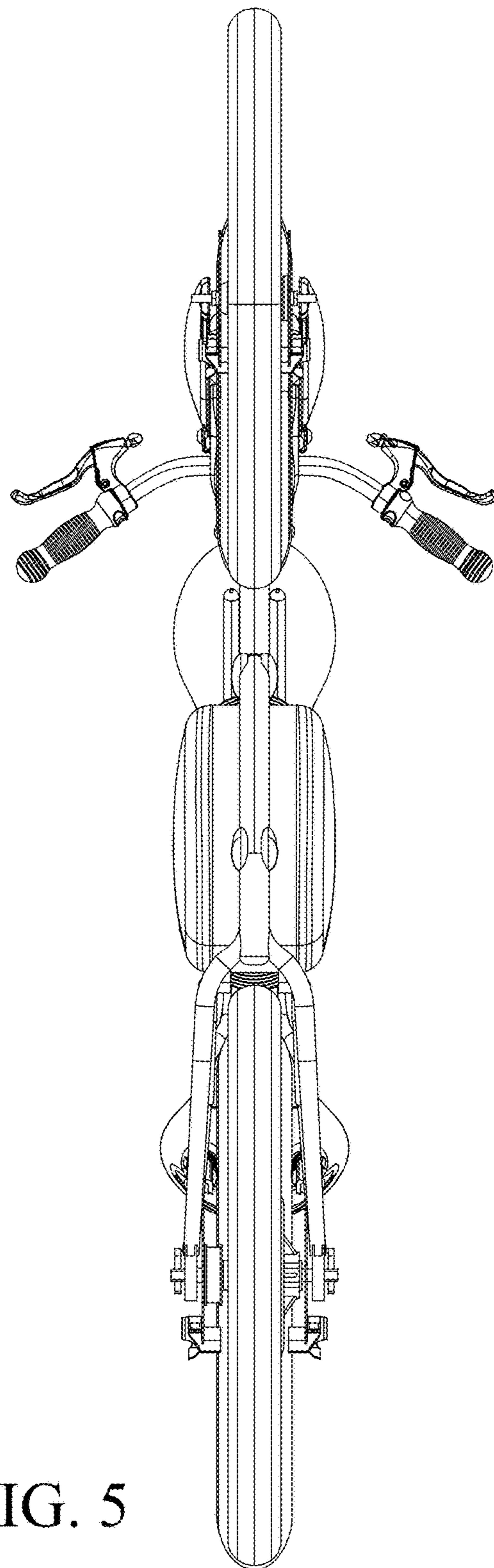

FIG. 5

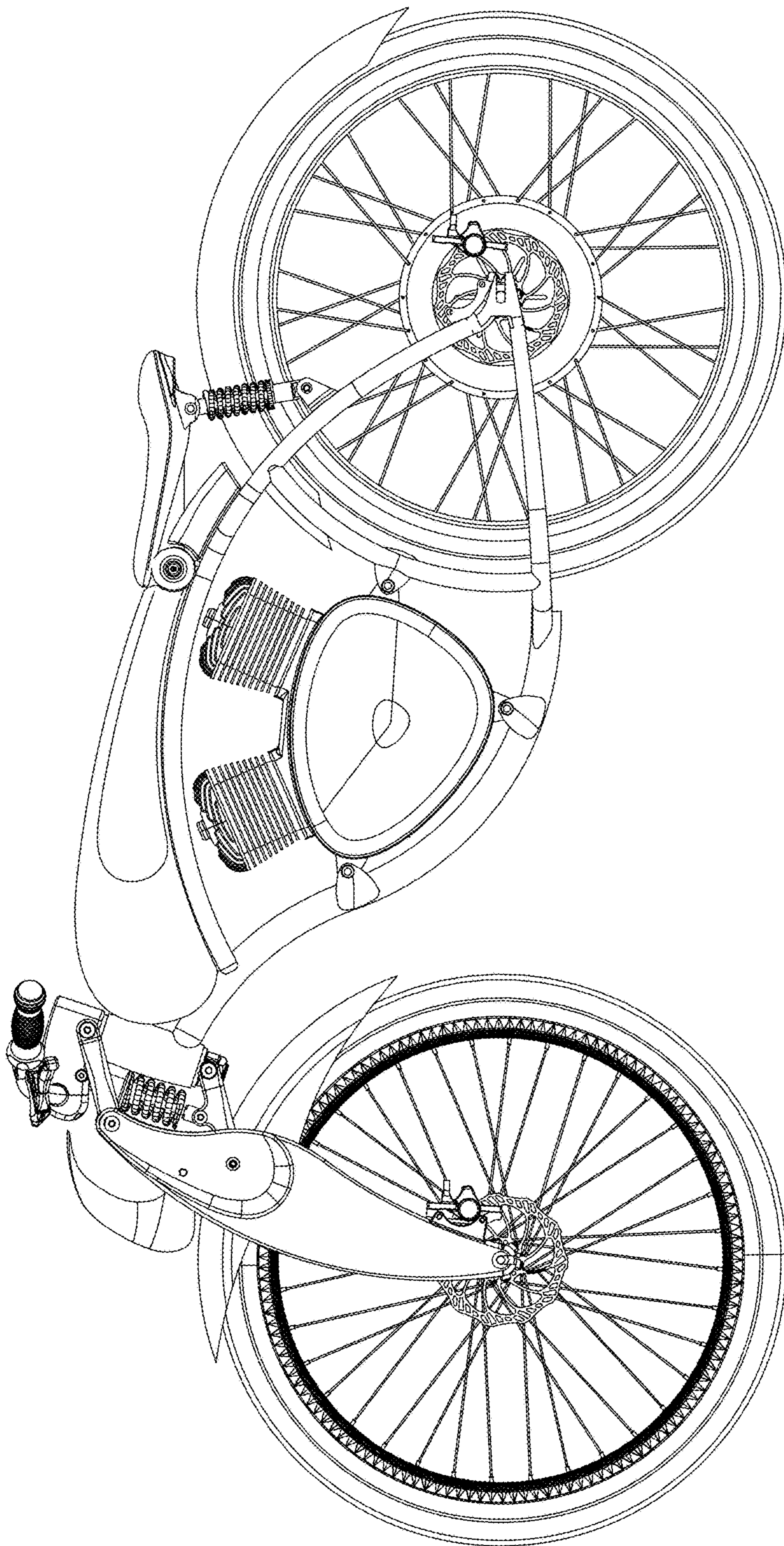

FIG. 6

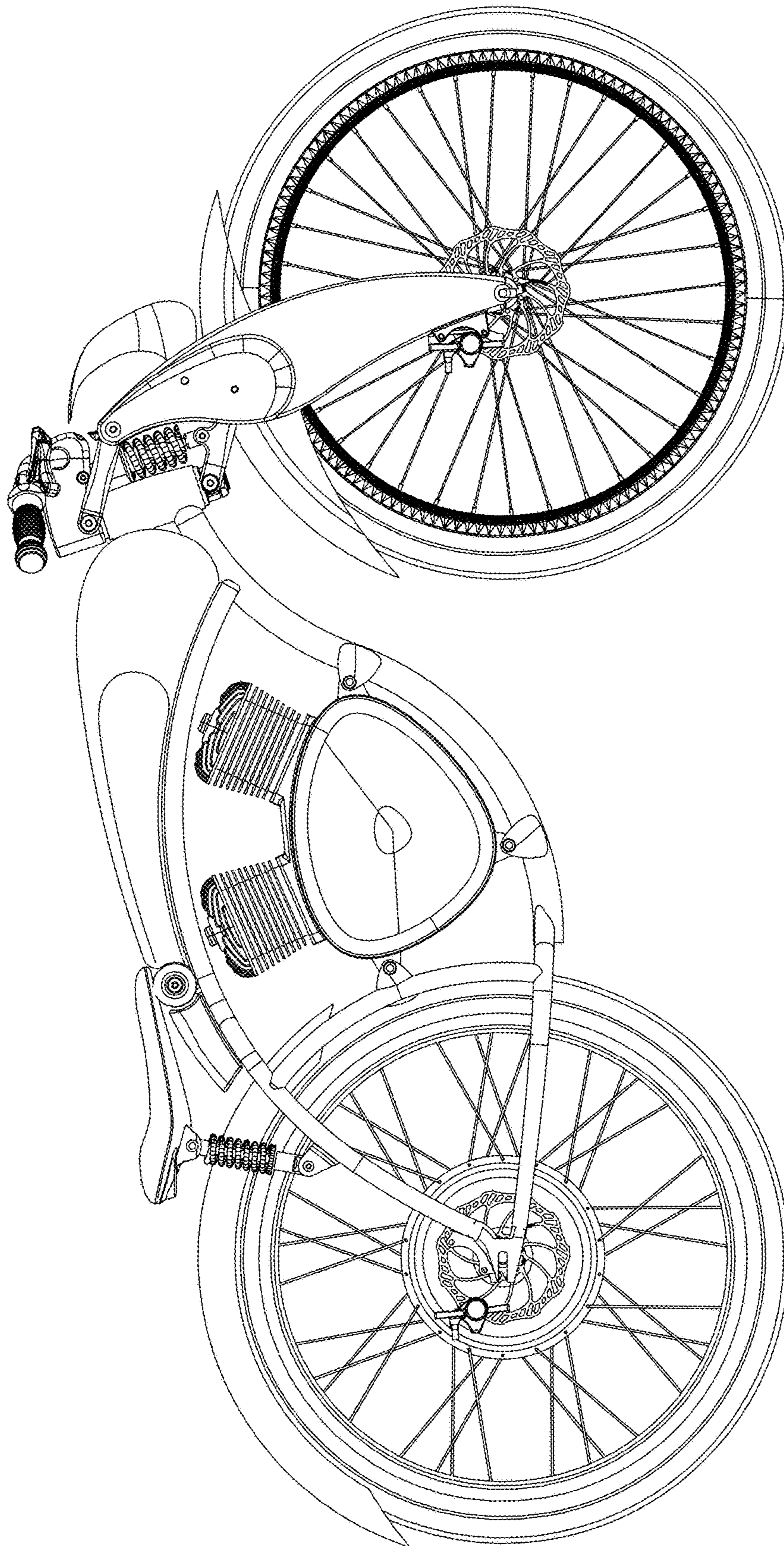

FIG. 7