



US00D836035S

(12) **United States Design Patent** (10) **Patent No.:** **US D836,035 S**
Scott et al. (45) **Date of Patent:** **** Dec. 18, 2018**

(54) **AUTOMOBILE BODY**
(71) Applicants: **Everard J Scott**, Sterling Heights, MI (US); **Michael C Gillam**, Oxford, MI (US); **Gregory Howell**, Farmington, MI (US)
(72) Inventors: **Everard J Scott**, Sterling Heights, MI (US); **Michael C Gillam**, Oxford, MI (US); **Gregory Howell**, Farmington, MI (US)

D703,586 S * 4/2014 Platto D12/98
D723,428 S * 3/2015 Sperling D12/98
D725,001 S * 3/2015 McMahan D12/98
D732,435 S * 6/2015 Mackay D12/98
D735,082 S * 7/2015 Sperling D12/98
D742,790 S * 11/2015 Noguchi D12/98
D748,014 S * 1/2016 Ino D12/98
D748,015 S * 1/2016 Ino D12/98
D755,082 S * 5/2016 Gillam D12/98
D755,083 S * 5/2016 Gillam et al.
D759,544 S * 6/2016 Chung D12/98
D803,727 S * 11/2017 Noone D12/98
D805,438 S * 12/2017 Scott D12/98

(73) Assignee: **FCA US LLC**, Auburn Hills, MI (US)

* cited by examiner

(**) Term: **15 Years**

Primary Examiner — Melody N Brown

(21) Appl. No.: **29/626,563**

(74) *Attorney, Agent, or Firm* — Ralph E. Smith

(22) Filed: **Nov. 17, 2017**

(51) **LOC (11) Cl.** **12-08**

(52) **U.S. Cl.**
USPC **D12/98**

(58) **Field of Classification Search**
USPC D12/86, 90–92, 88, 98; D21/424, 433, D21/434, 533; 296/181.1, 181.5, 181.3, 296/183.1, 37.6
CPC B60R 9/06; B62D 35/00
See application file for complete search history.

(56) **References Cited**

U.S. PATENT DOCUMENTS

D586,699 S * 2/2009 Opfer D12/98
D588,501 S 3/2009 Krugger et al.
D659,053 S * 5/2012 Ware D12/98

(57) **CLAIM**

The ornamental design for an automobile body, as shown and described.

DESCRIPTION

FIG. 1 is a front perspective view of an automobile body showing our new design;
FIG. 2 is a rear perspective view thereof;
FIG. 3 is a front view thereof;
FIG. 4 is a rear view thereof;
FIG. 5 is a top plan view thereof; and,
FIG. 6 is a side view thereof.

It will be understood that the broken lines shown in the drawings illustrate portions of the automobile body that form no part of claimed design.

1 Claim, 6 Drawing Sheets

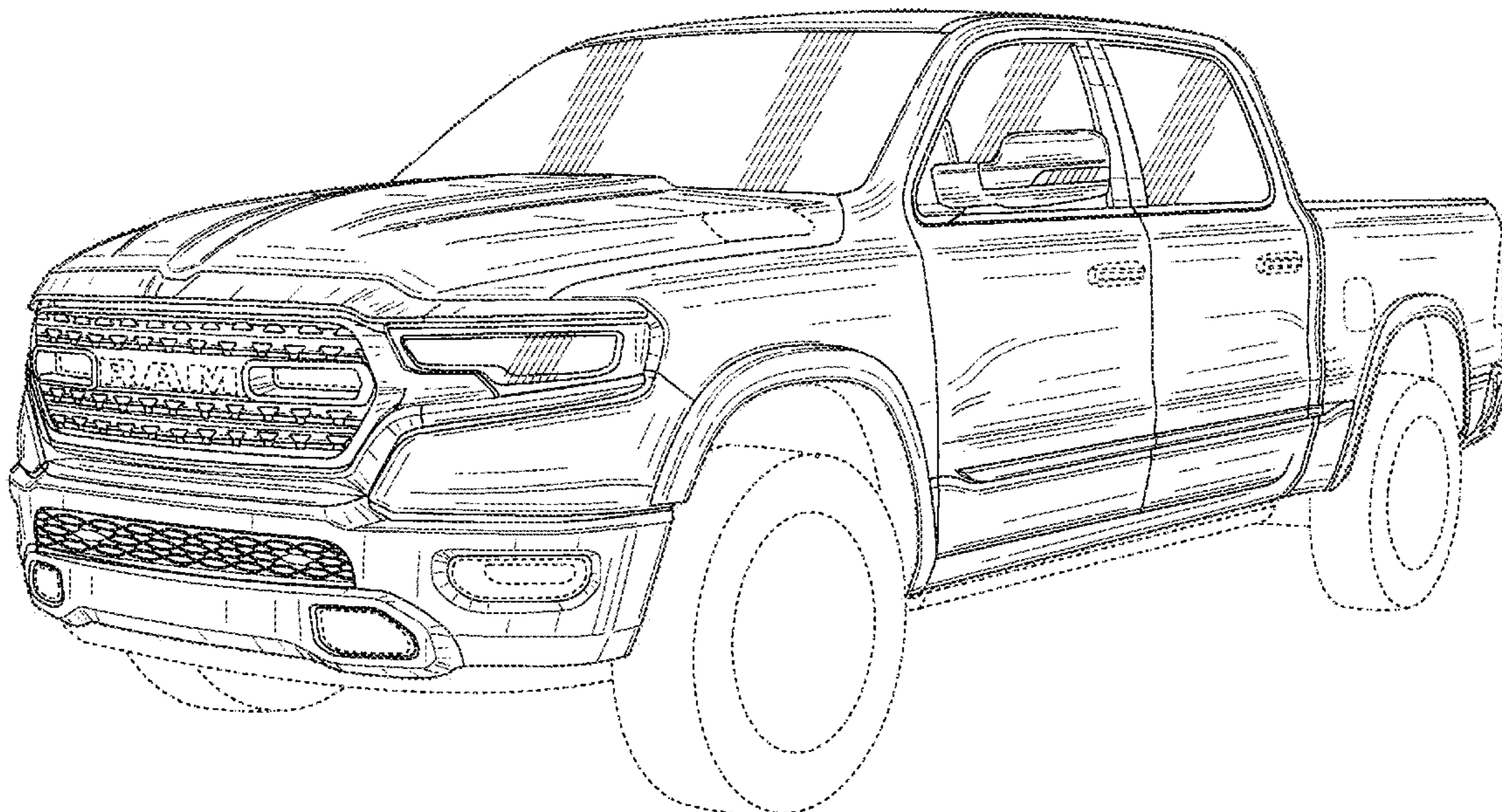

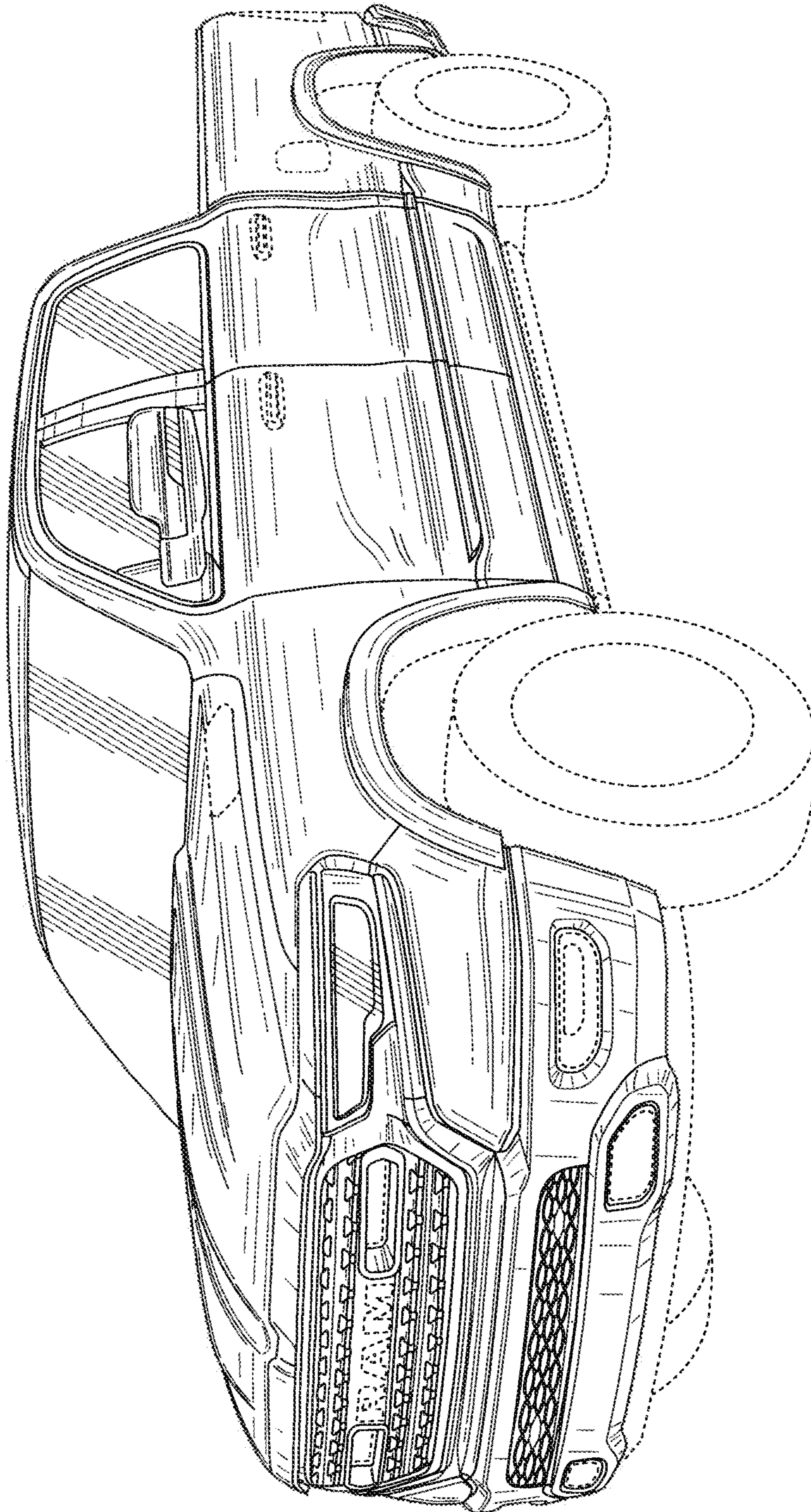

FIG. 1

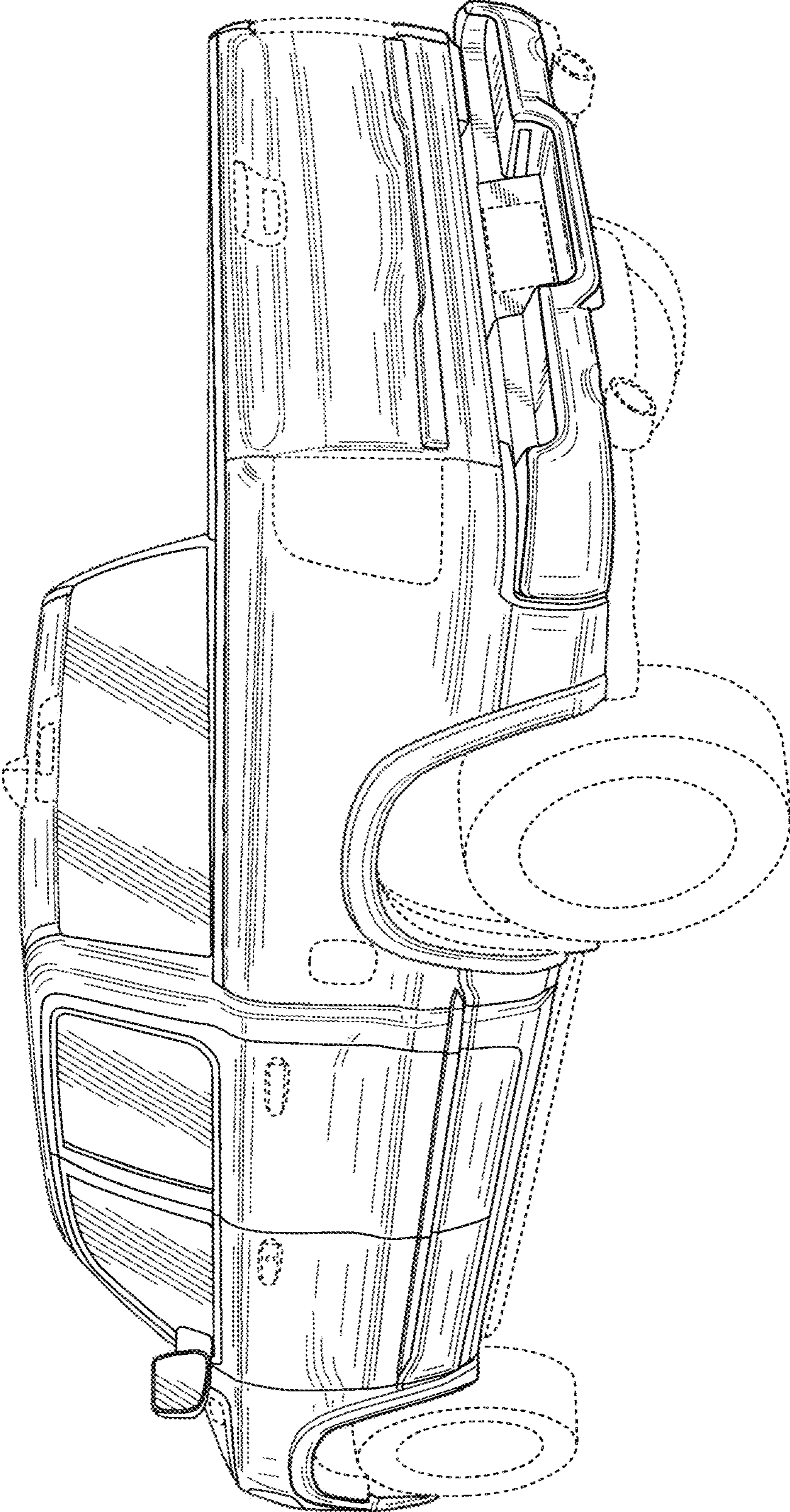

FIG. 2

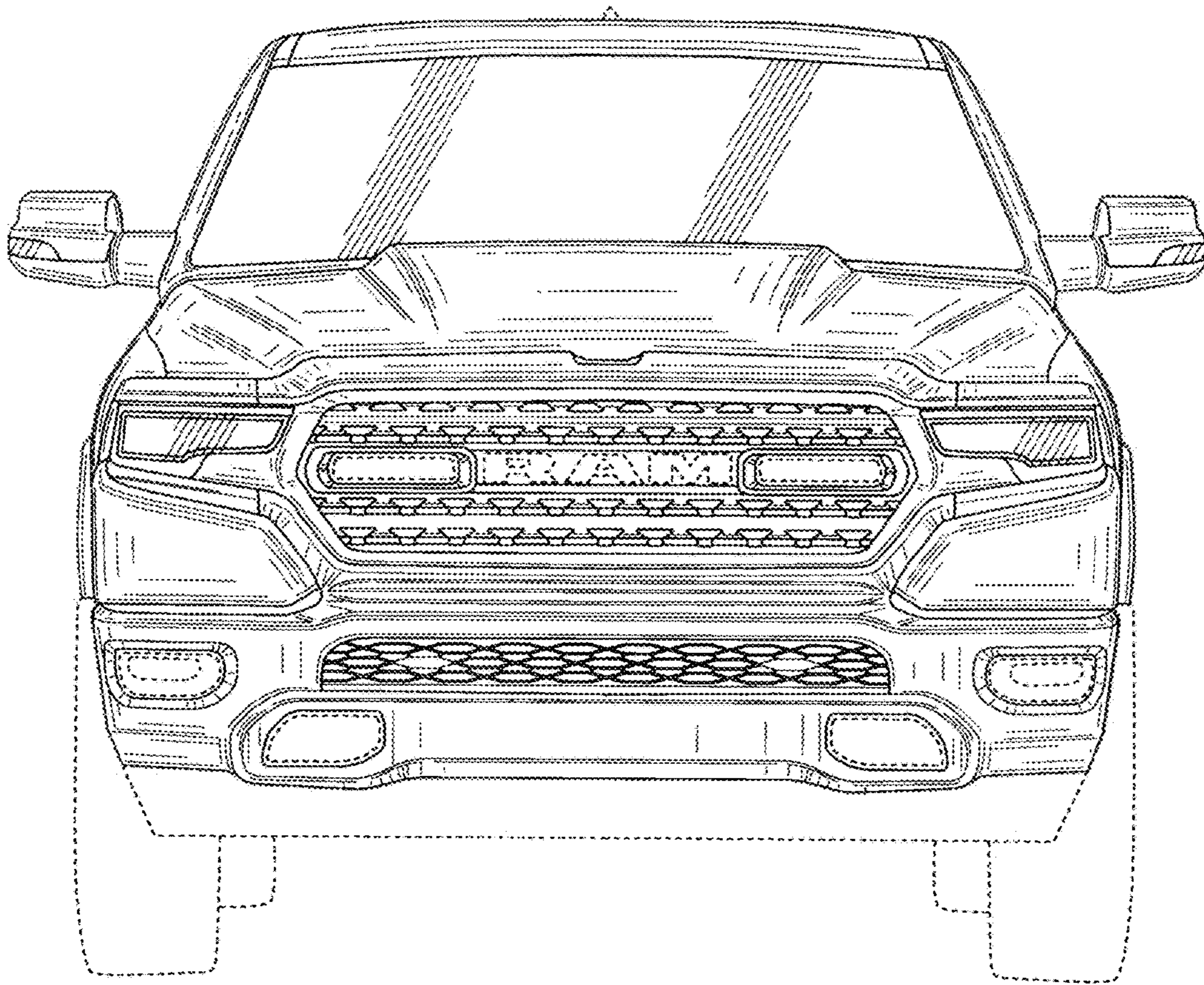

FIG. 3

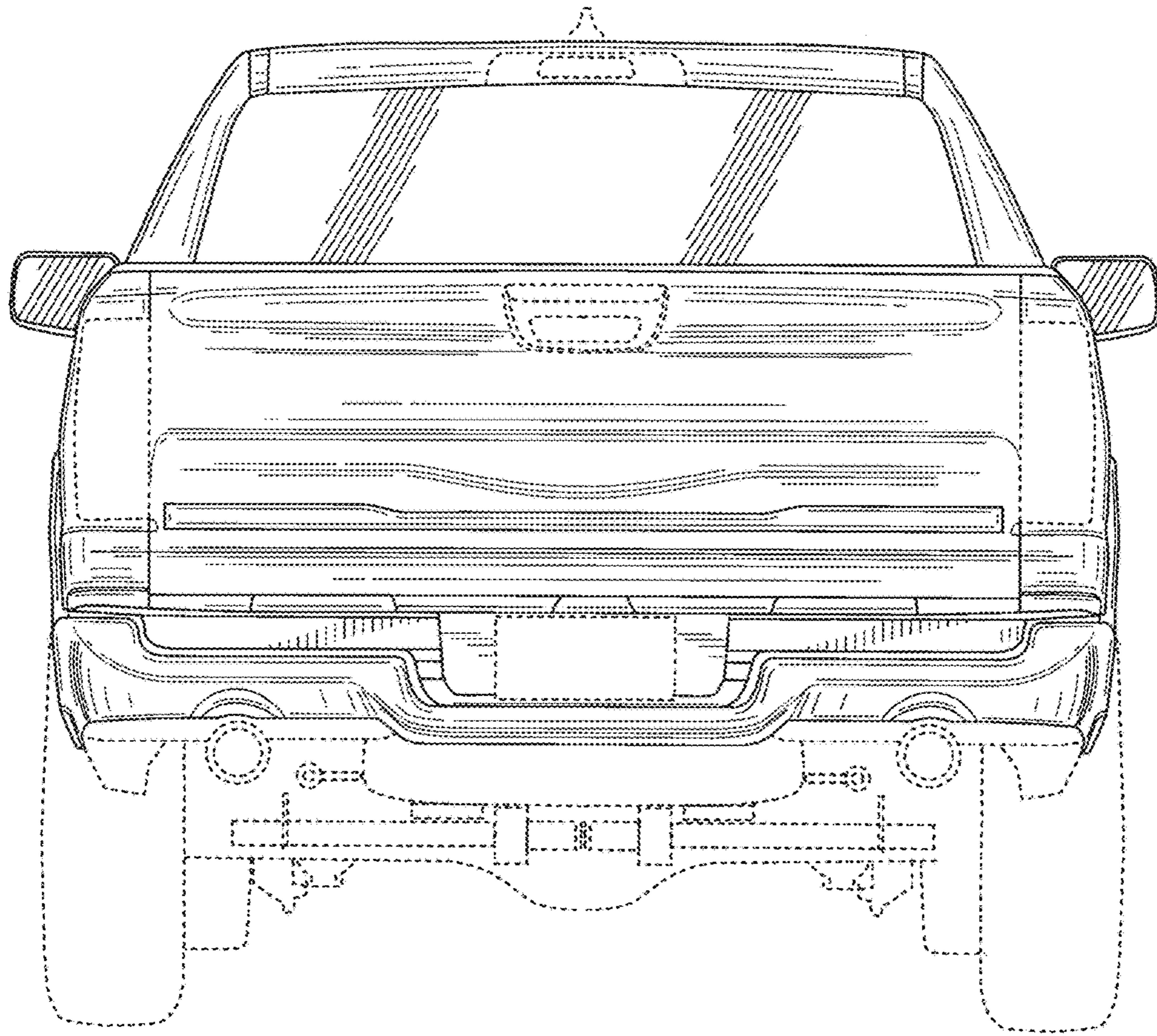

FIG. 4

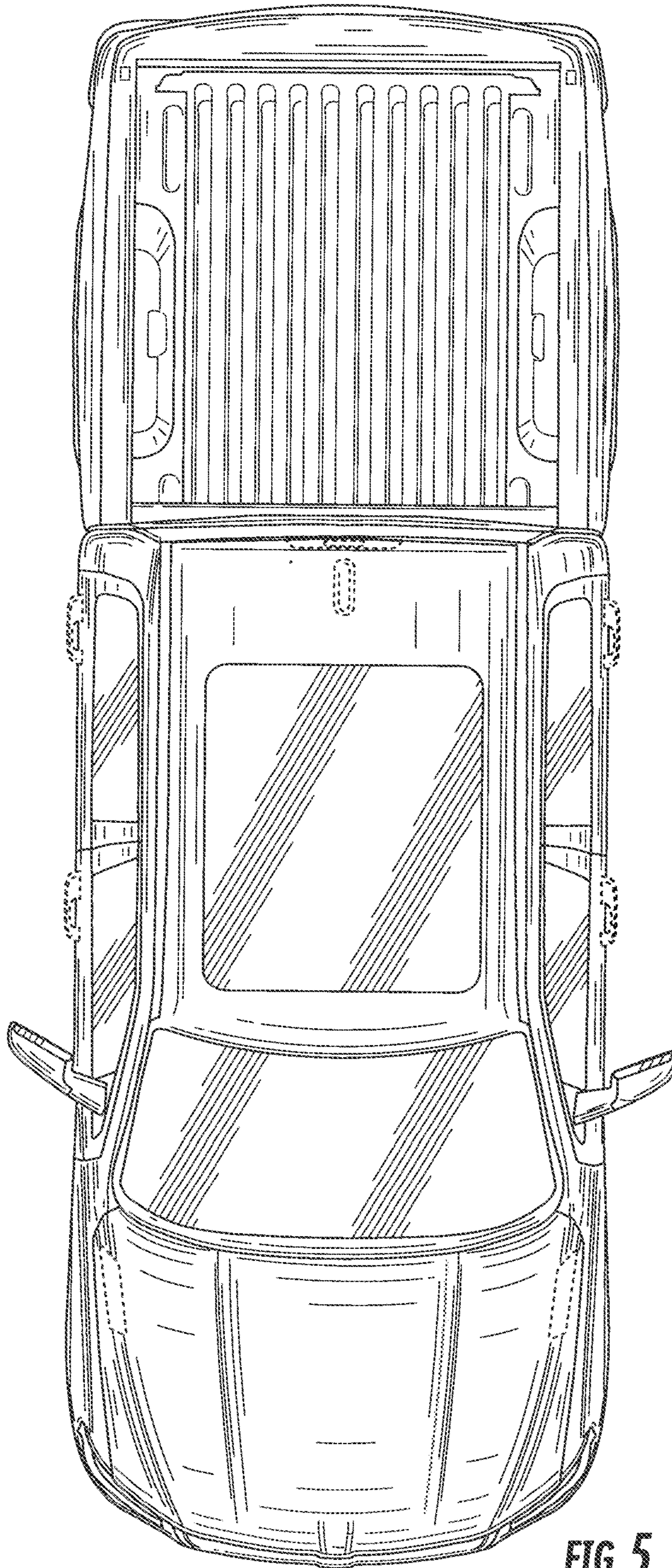

FIG. 5

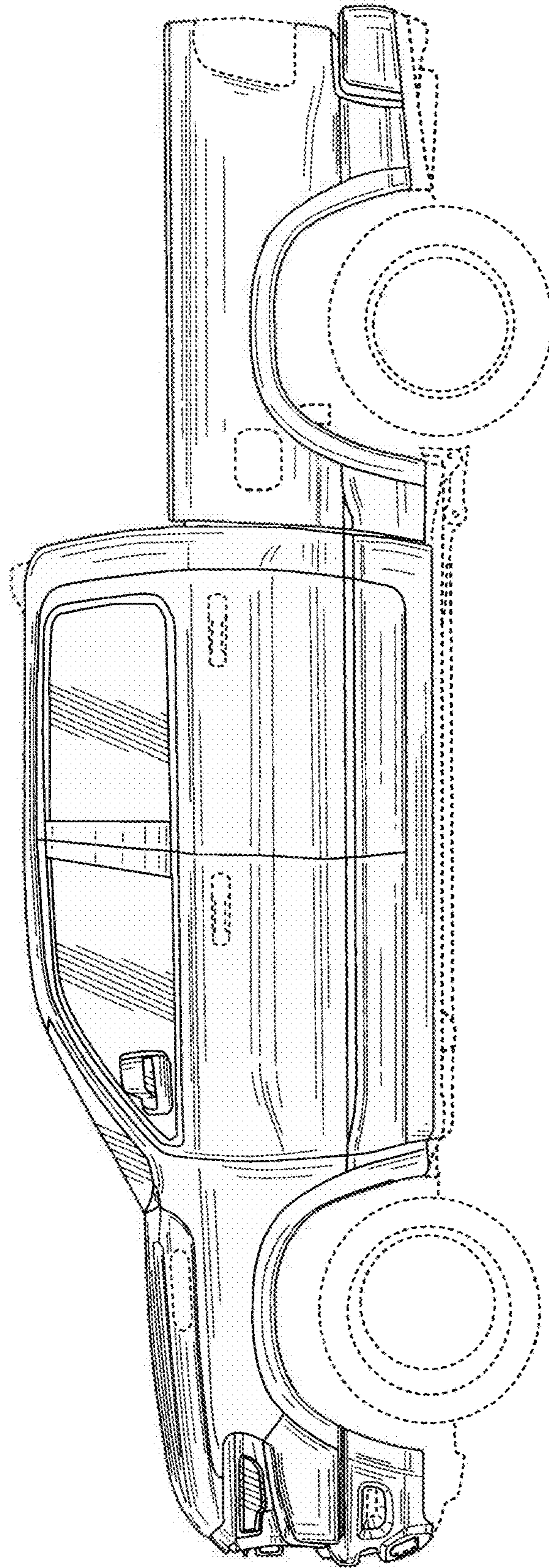

FIG. 6