



US00D835999S

(12) **United States Design Patent** (10) **Patent No.:** **US D835,999 S**  
**Vandenbos** (45) **Date of Patent:** **\*\* Dec. 18, 2018**

(54) **SURFACE ORNAMENTATION FOR A CONTAINER**

(71) Applicant: **Rodney W. Vandenbos**, Palm Desert, CA (US)

(72) Inventor: **Rodney W. Vandenbos**, Palm Desert, CA (US)

(73) Assignee: **Buzzbox Beverages, Inc.**, Palm Desert, CA (US)

(\*\*) Term: **15 Years**

(21) Appl. No.: **29/612,884**

(22) Filed: **Aug. 4, 2017**

(51) **LOC (11) Cl.** ..... **09-01**

(52) **U.S. Cl.**  
USPC ..... **D9/600; D9/434**

(58) **Field of Classification Search**  
USPC ..... D3/270, 271.1–271.4; D9/600, 649, D9/414–434; 206/457, 459.5, 527; 215/381–384, 400; 229/116.1, 137, 140  
(Continued)

(56) **References Cited**

**U.S. PATENT DOCUMENTS**

D140,559 S \* 3/1945 Clark ..... D9/600  
4,294,362 A \* 10/1981 Martensson ..... B65D 5/065  
229/140

(Continued)

**OTHER PUBLICATIONS**

Distillerista Buzzbox cocktail review, Jun. 24, 2016. <http://distillerista.com/buzz-boxes/>.\*

*Primary Examiner* — Sandra L Morris

(74) *Attorney, Agent, or Firm* — Barnes & Thornburg, LLP

(57) **CLAIM**

I claim the ornamental design for a surface ornamentation for a container, as shown and described.

**DESCRIPTION**

FIG. 1 is a perspective view of surface ornamentation on a container according to a new design; FIG. 2 is a front view thereof; FIG. 3 is a rear view thereof; FIG. 4 is a left side view thereof; FIG. 5 is a right side view thereof; FIG. 6 is a top view thereof; FIG. 7 is a bottom view thereof; FIG. 8 is a perspective view of a second embodiment of surface ornamentation on a container according to a new design; FIG. 9 is a front view thereof; FIG. 10 is a rear view thereof; FIG. 11 is a left side view thereof; FIG. 12 is a right side view thereof; FIG. 13 is a top view thereof; FIG. 14 is a bottom view thereof; FIG. 15 is a perspective view of a third embodiment of a line arrangement forming surface ornamentation on a container according to a new design; FIG. 16 is a front view thereof; FIG. 17 is a rear view thereof; FIG. 18 is a left side view thereof; FIG. 19 is a right side view thereof; FIG. 20 is a top view thereof; FIG. 21 is a bottom view thereof; FIG. 22 is a perspective view of a fourth embodiment of a line arrangement forming surface ornamentation on a container according to a new design; FIG. 23 is a front view thereof; FIG. 24 is a rear view thereof; FIG. 25 is a left side view thereof; FIG. 26 is a right side view thereof; FIG. 27 is a top view thereof; and, FIG. 28 is a bottom view thereof.

(Continued)

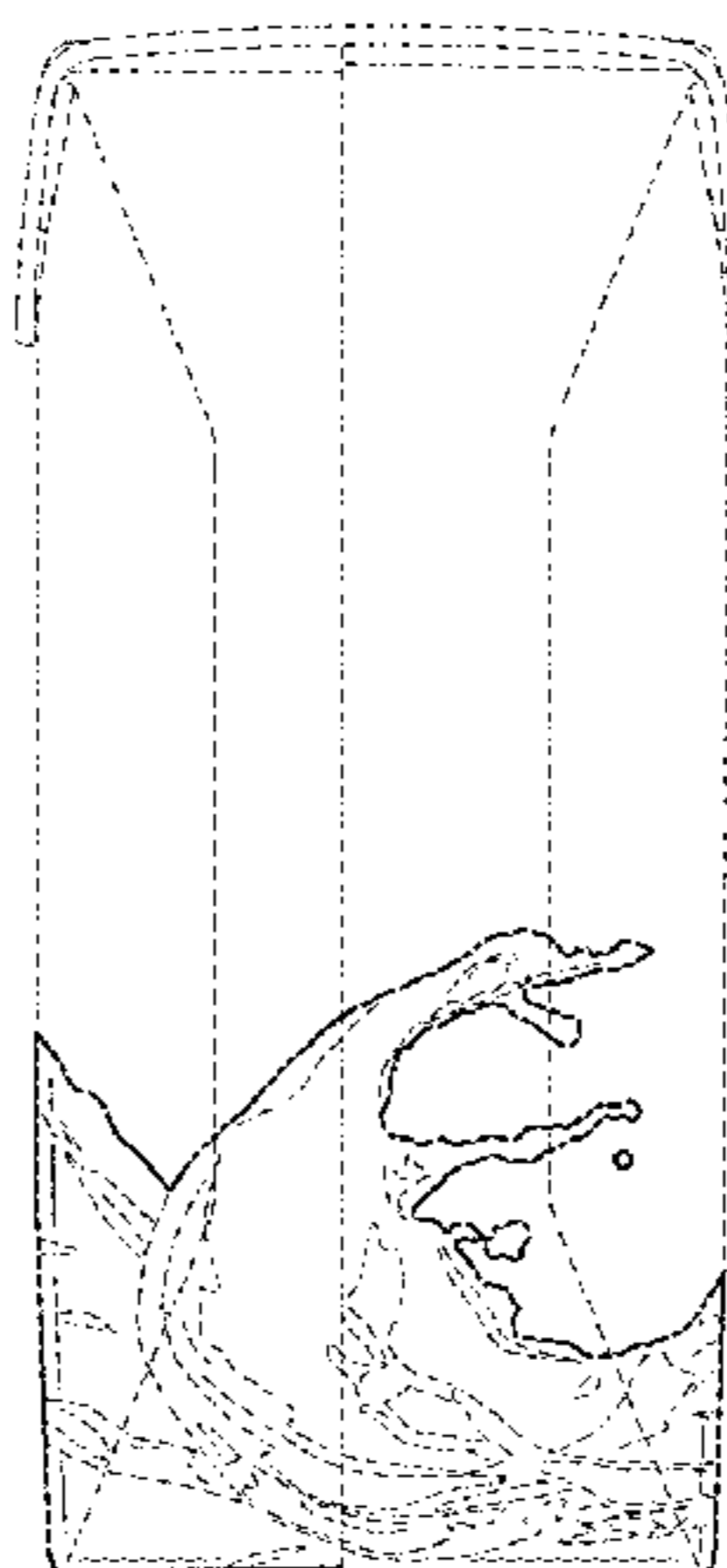
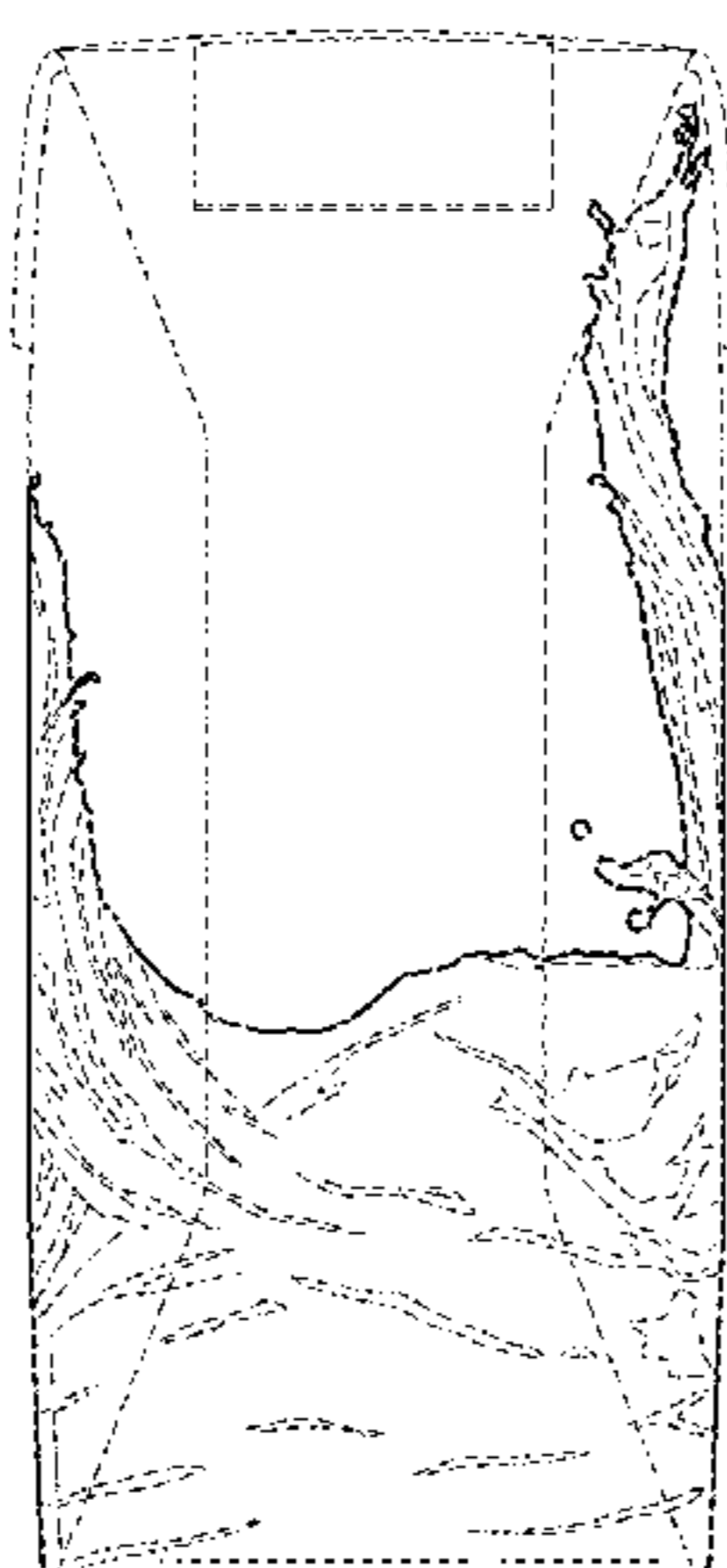

Features shown in broken lines in the drawings are not part of the claim.

**1 Claim, 12 Drawing Sheets**

**(58) Field of Classification Search**

CPC ..... B65D 5/42; B65D 5/4208; B65D 81/30;  
 B65D 81/60; B65D 81/365; B65D  
 81/366; B65D 81/368; B65D 2203/00;  
 B65D 2203/02; B65D 67/00; B65D 5/75;  
 B65D 71/16; B65D 71/20; B65D 5/08;  
 B65D 5/065; A63H 81/16

See application file for complete search history.

**(56) References Cited**

U.S. PATENT DOCUMENTS

4,343,402 A \* 8/1982 Holmstrom ..... B65D 5/065  
 229/216  
 D281,668 S \* 12/1985 Berard ..... D9/416

5,474,232 A \* 12/1995 Ljungstrom ..... B65D 5/067  
 229/137  
 D464,566 S \* 10/2002 Anchor ..... D9/432  
 D494,861 S \* 8/2004 Guidotti ..... D9/431  
 D558,058 S \* 12/2007 Raso ..... D9/600  
 D617,386 S \* 6/2010 Heinke ..... D20/20  
 D617,843 S \* 6/2010 Heinke ..... D20/23  
 D621,275 S \* 8/2010 Marotti ..... D9/600  
 D634,625 S \* 3/2011 Wallace ..... D9/433  
 D635,018 S \* 3/2011 Wallace ..... D9/433  
 D656,837 S \* 4/2012 Lanz ..... D9/434  
 D677,335 S \* 3/2013 Murphy ..... D9/600  
 D691,882 S \* 10/2013 Barbieri ..... D9/430  
 D714,638 S \* 10/2014 Mohn ..... D9/432  
 D715,640 S \* 10/2014 Okezawa ..... B65D 5/067  
 D9/430  
 D721,576 S \* 1/2015 De Pietri Tonelli ..... D9/431  
 D733,556 S \* 7/2015 De Pietri Tonelli ... B65D 5/065  
 D9/431  
 D748,470 S \* 2/2016 Mohn ..... B65D 5/065  
 D9/432  
 D764,283 S \* 8/2016 Mohn ..... D9/432

\* cited by examiner

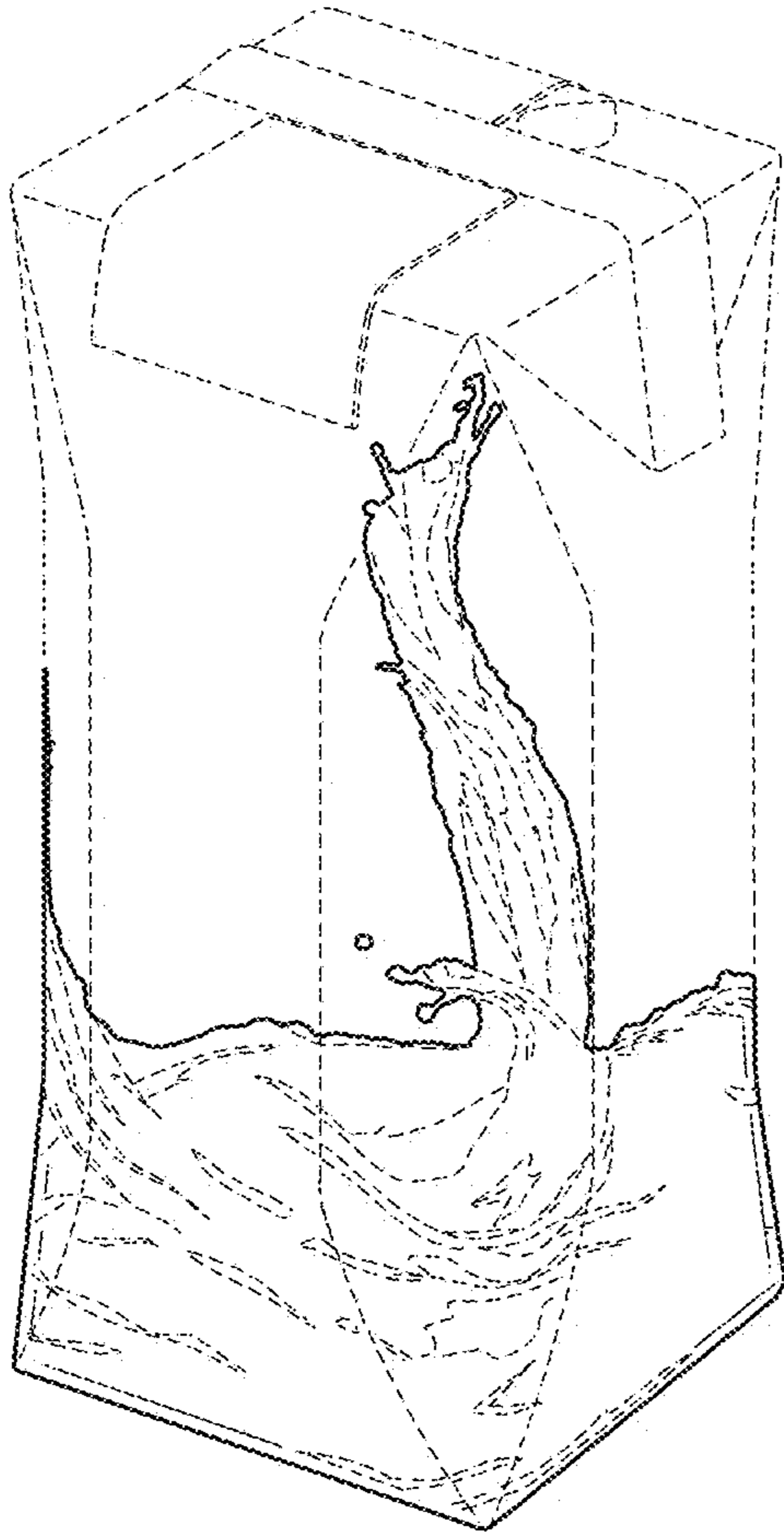
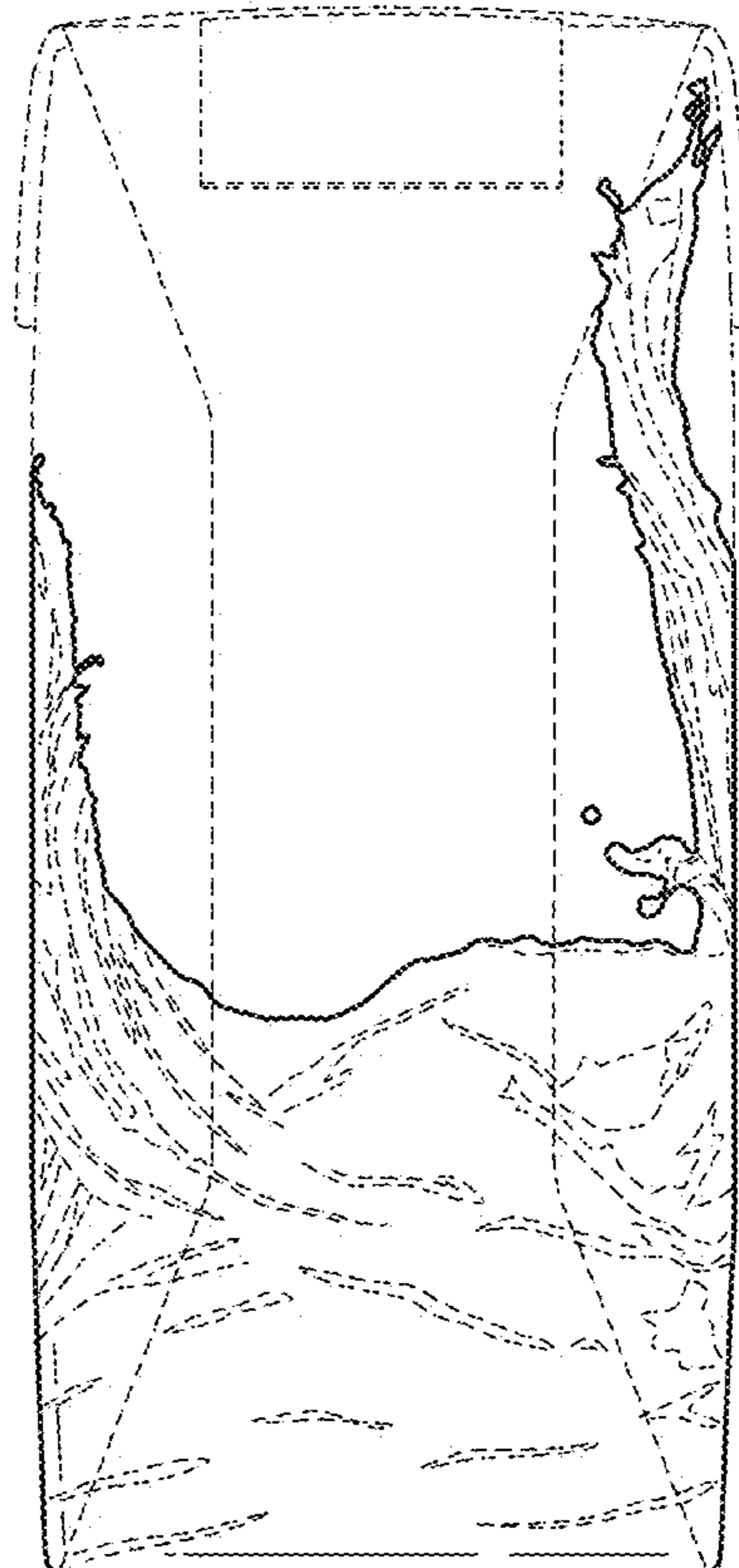

FIG. 1

FIG. 2



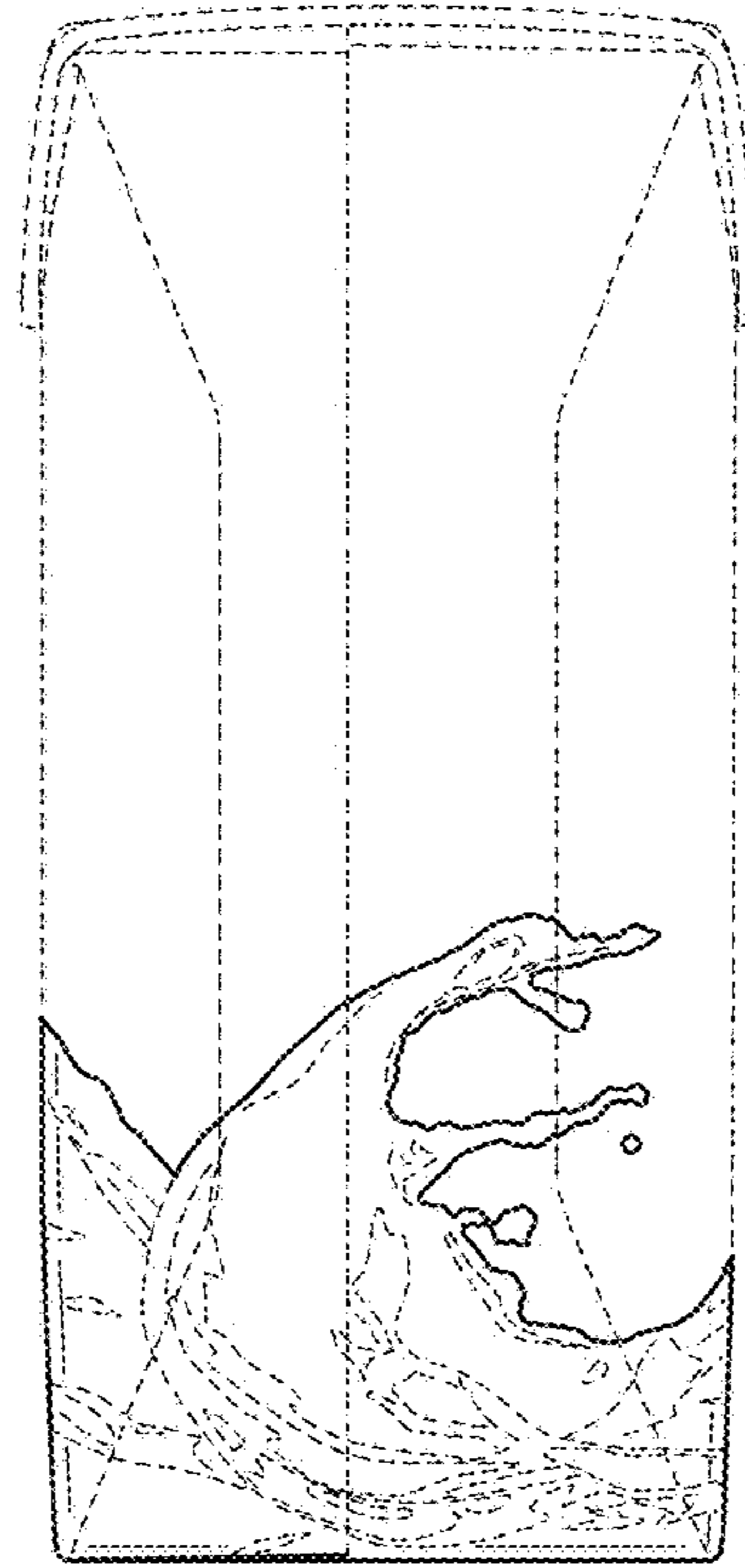

FIG. 3

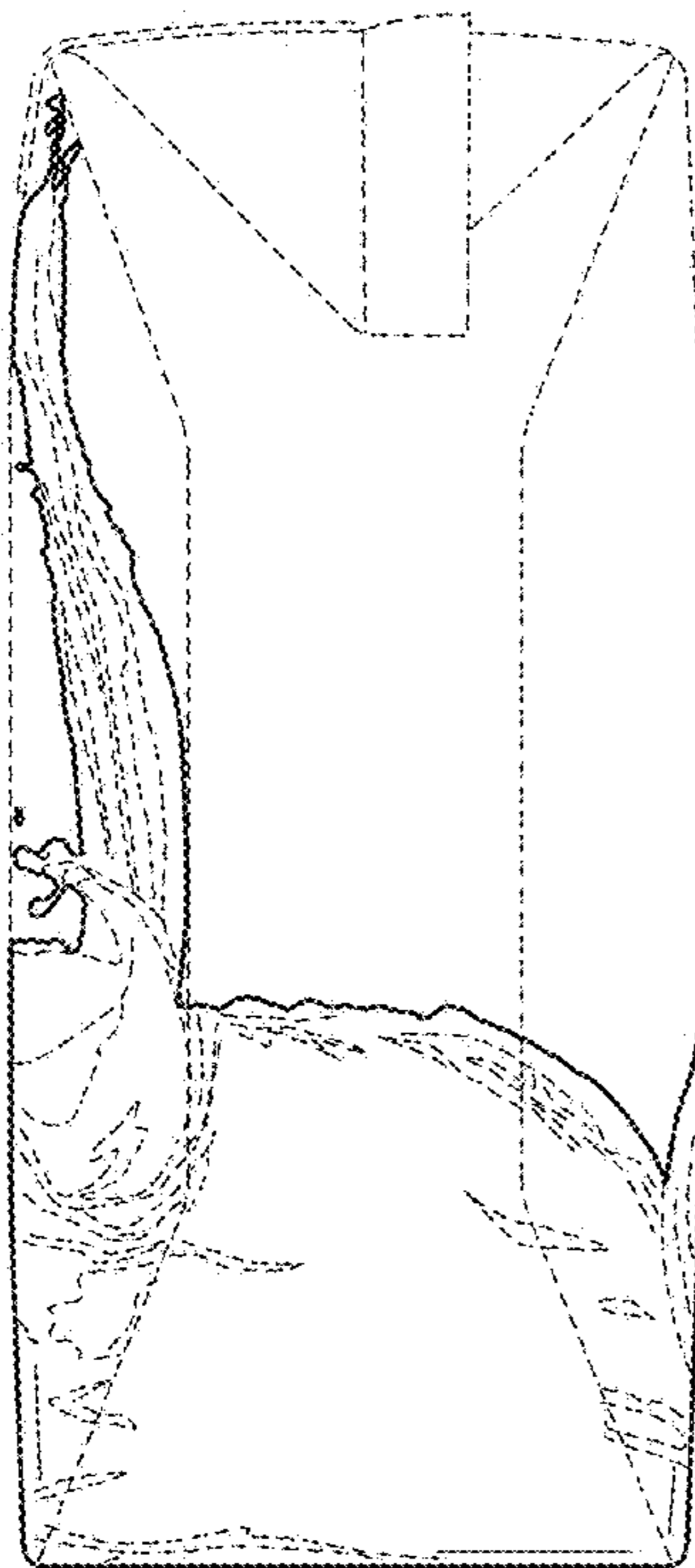

FIG. 4



FIG. 5

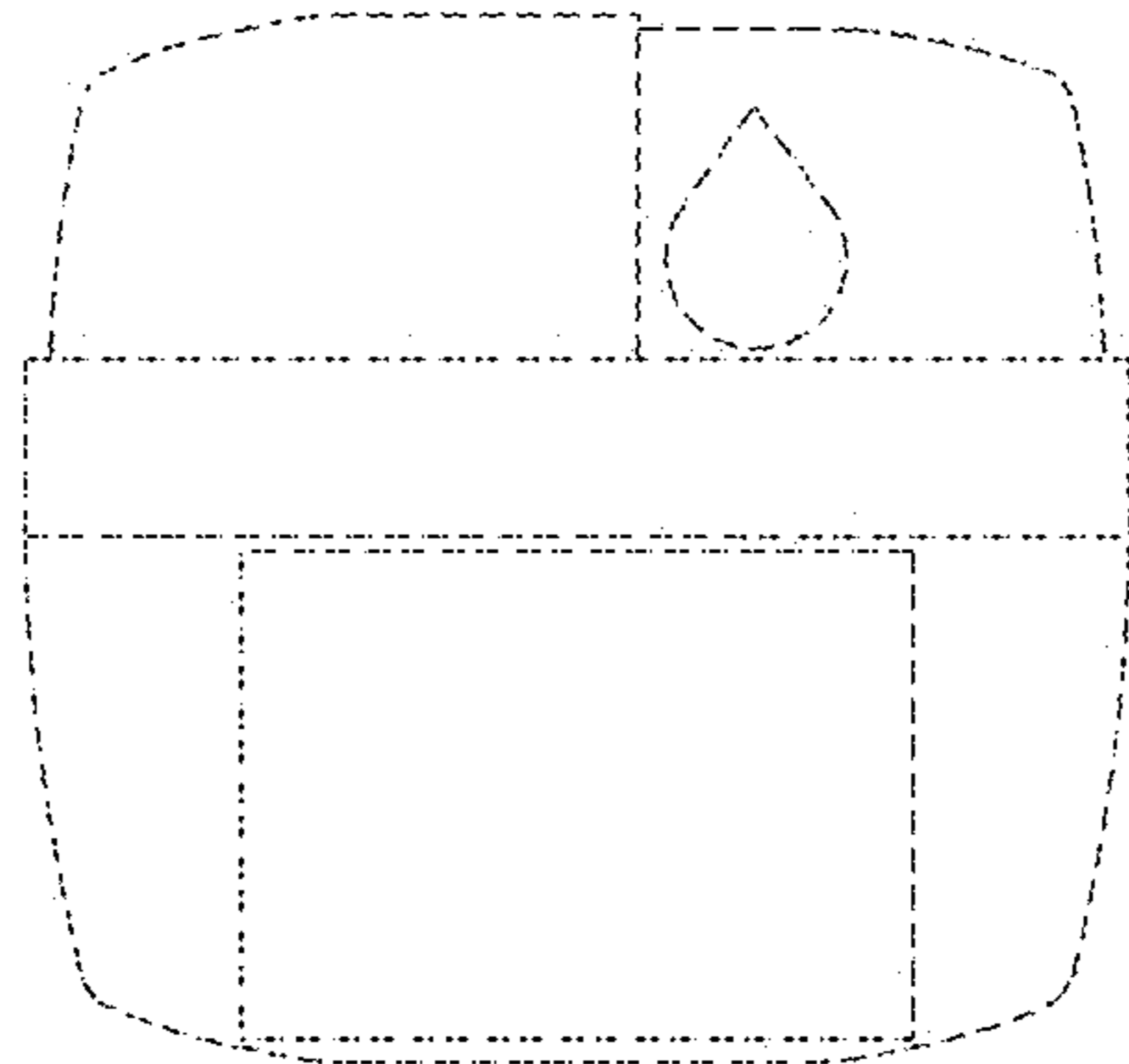

FIG. 6

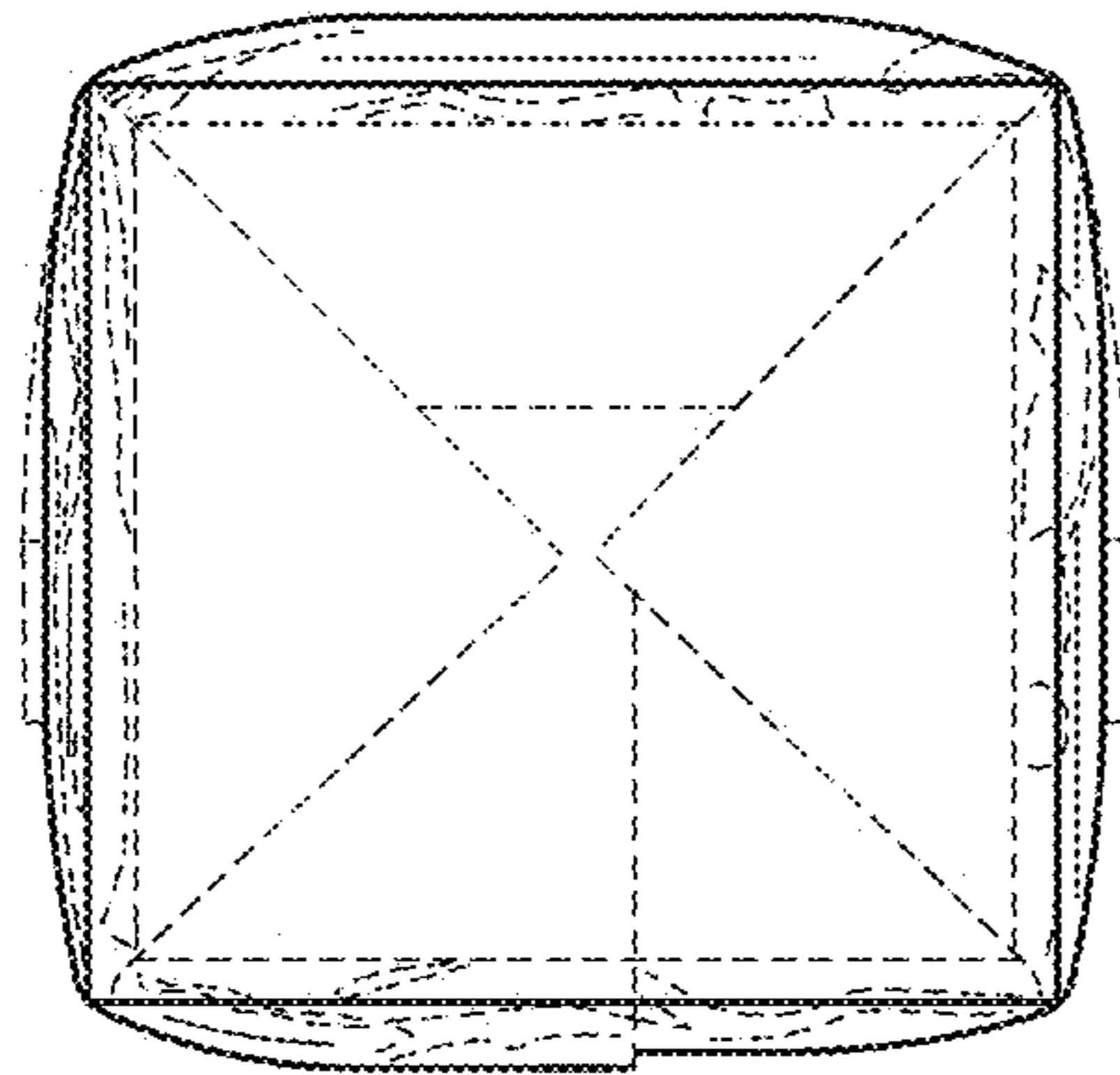

FIG. 7

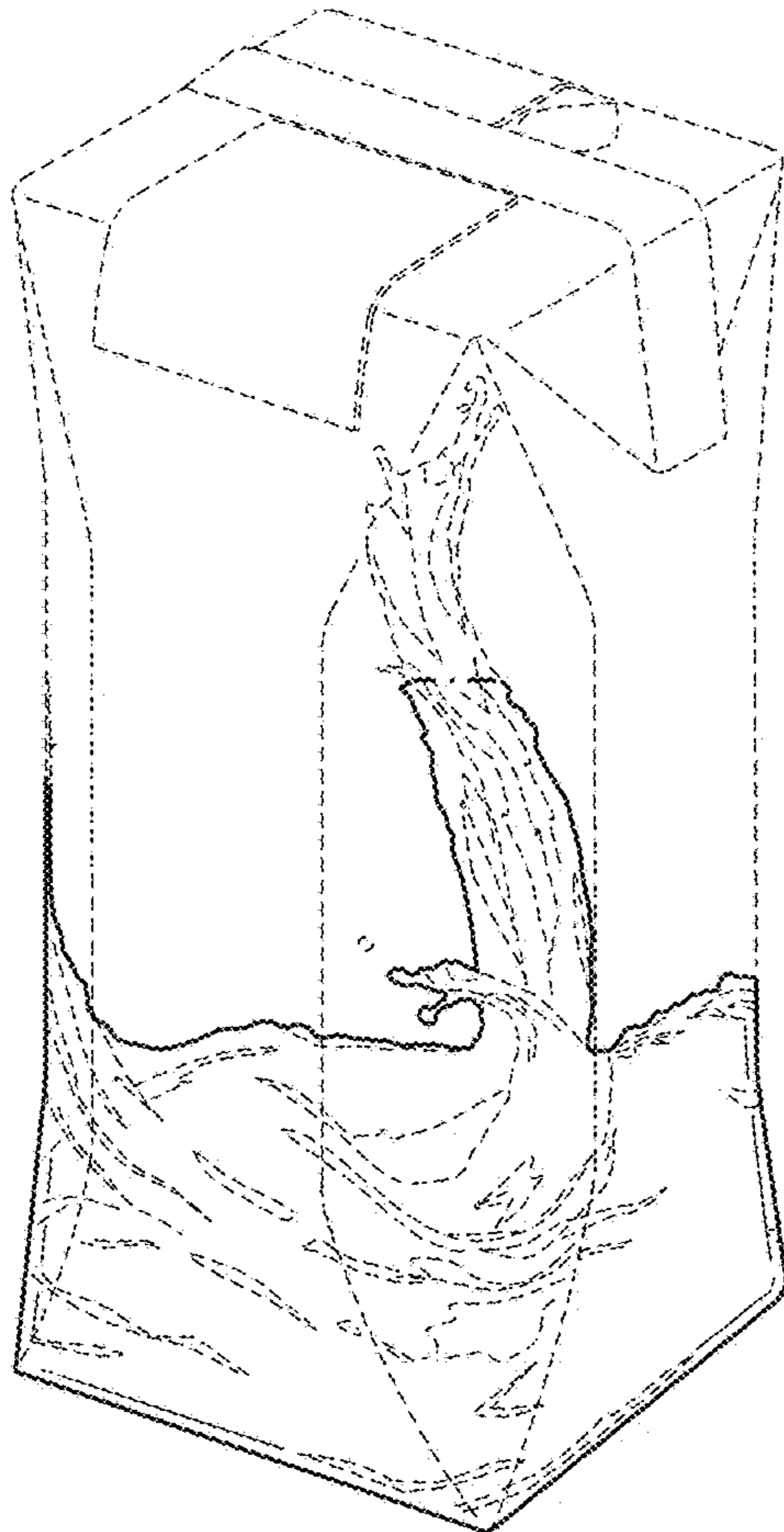

FIG. 8

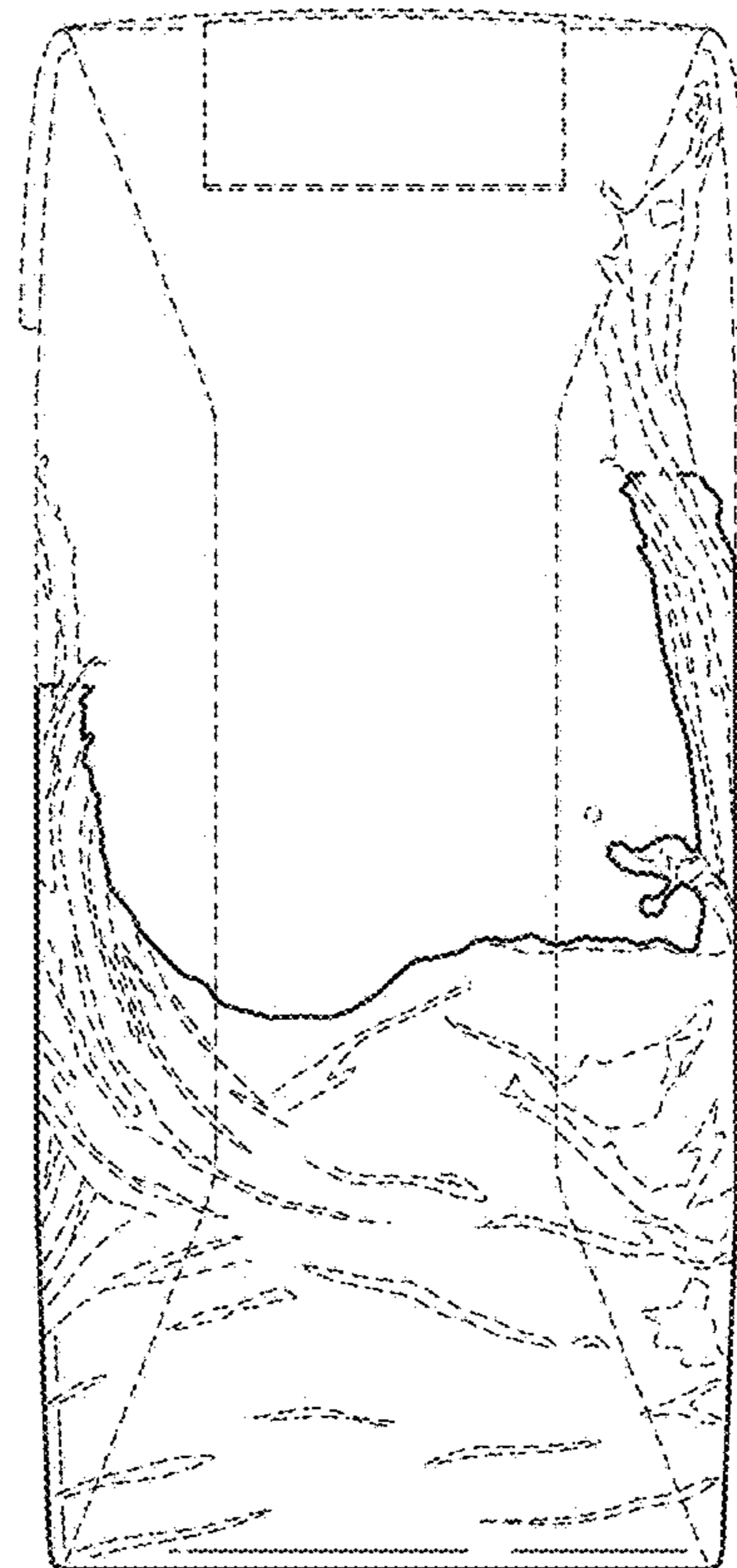

FIG. 9

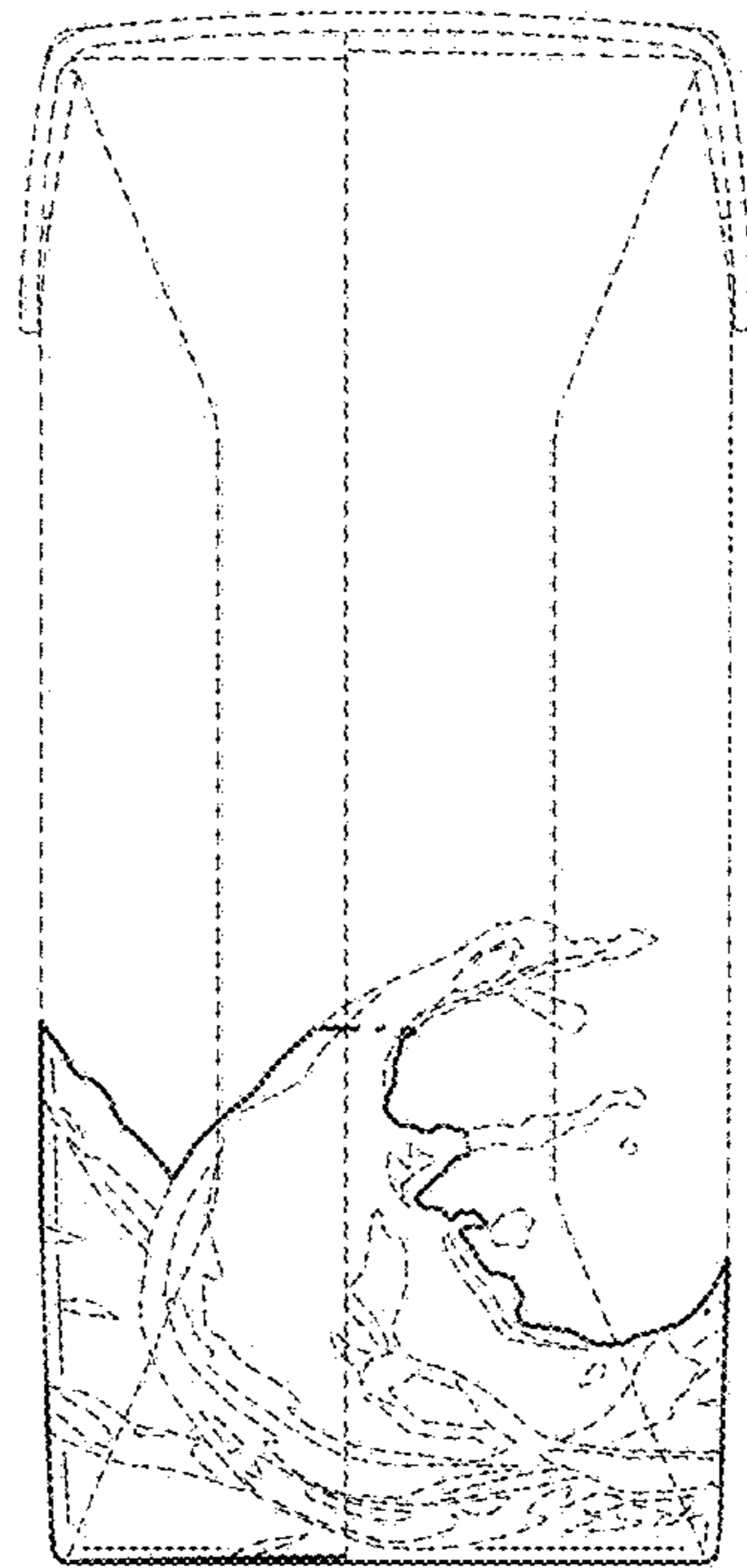

FIG. 10

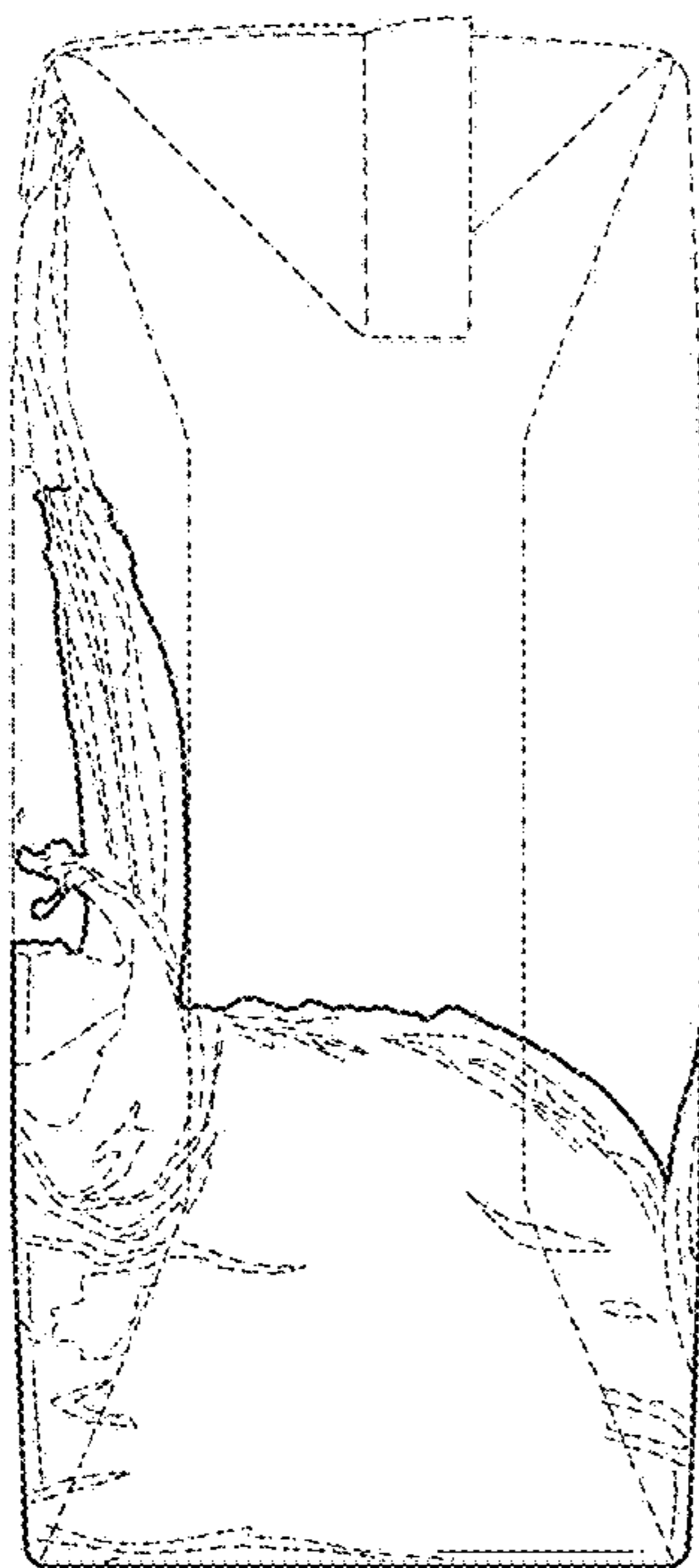

FIG. 11

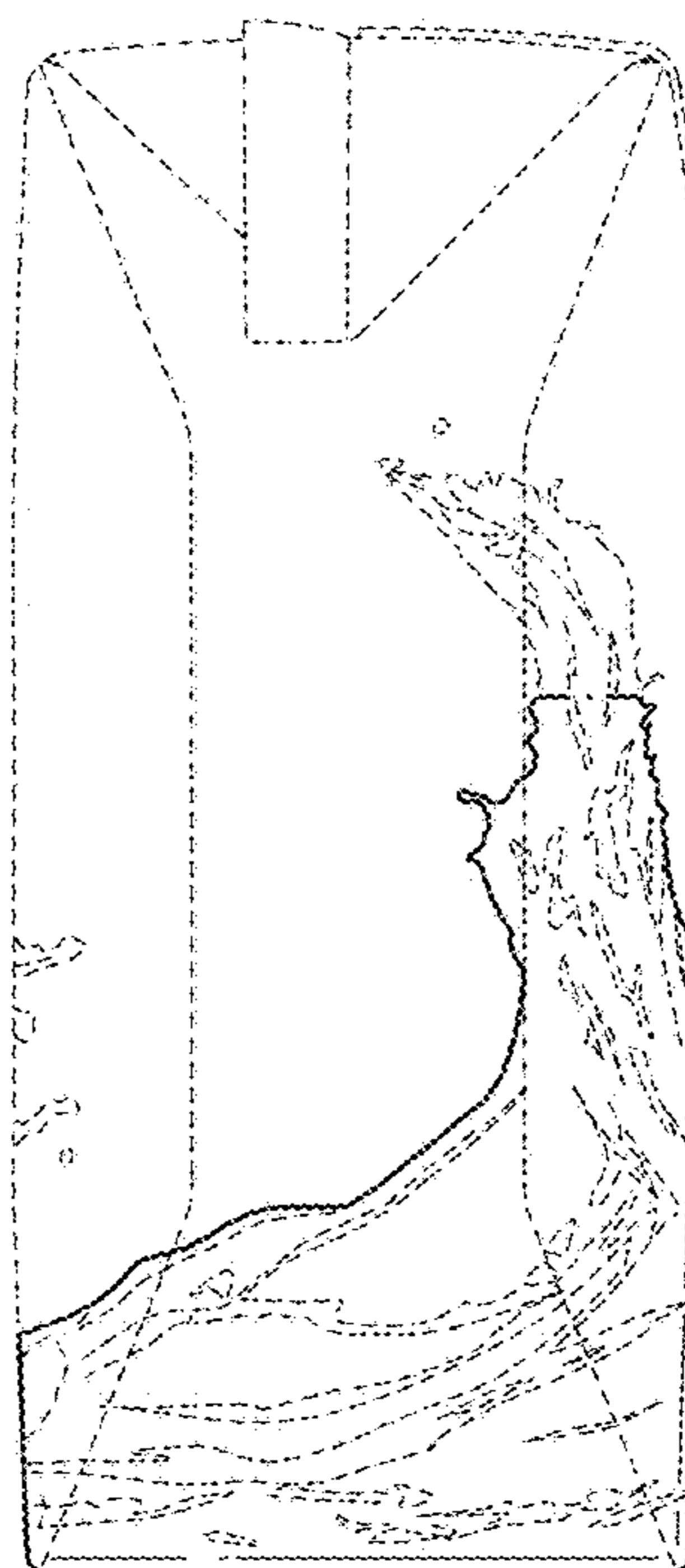

FIG. 12

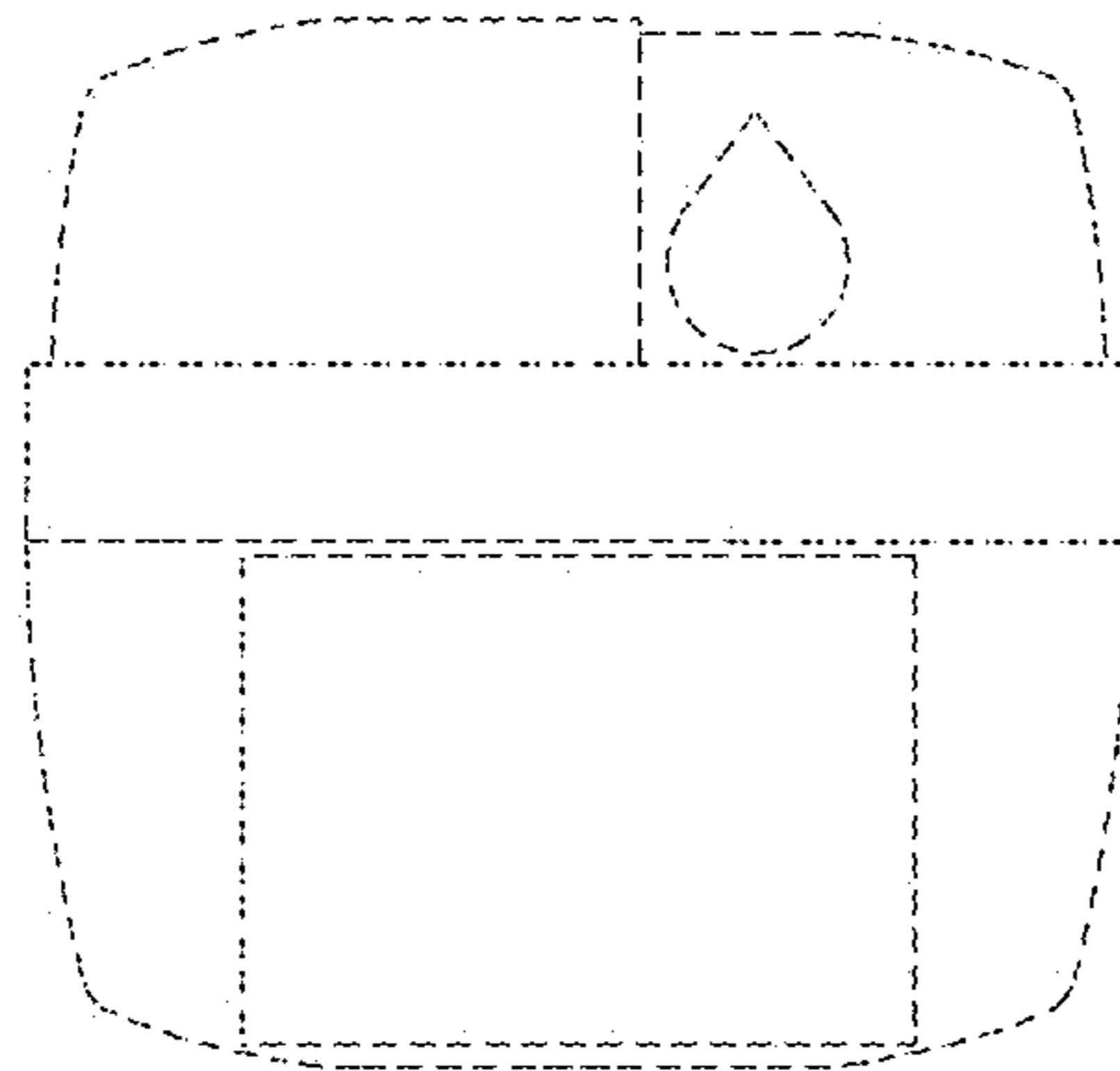

FIG. 13

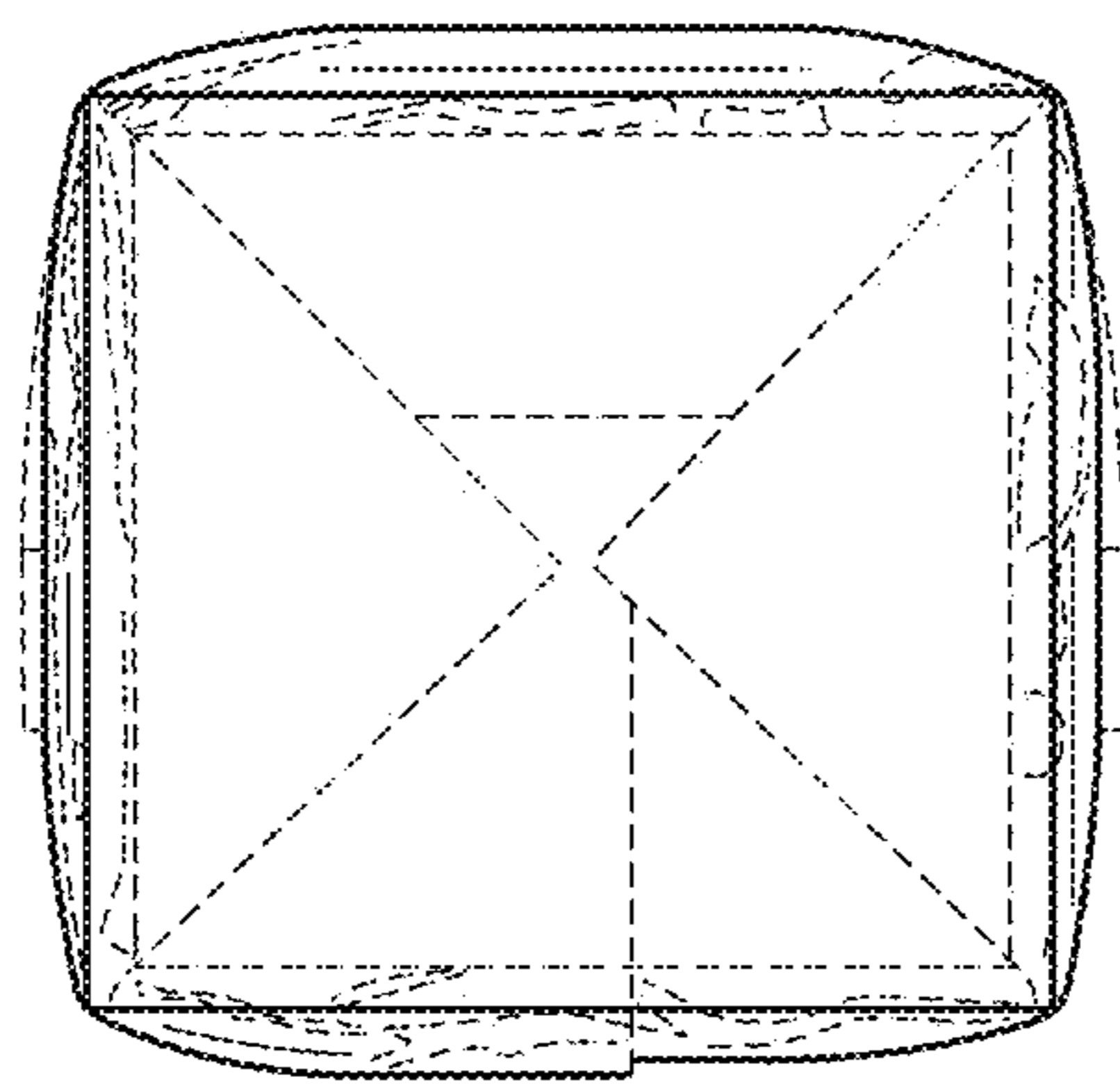

FIG. 14



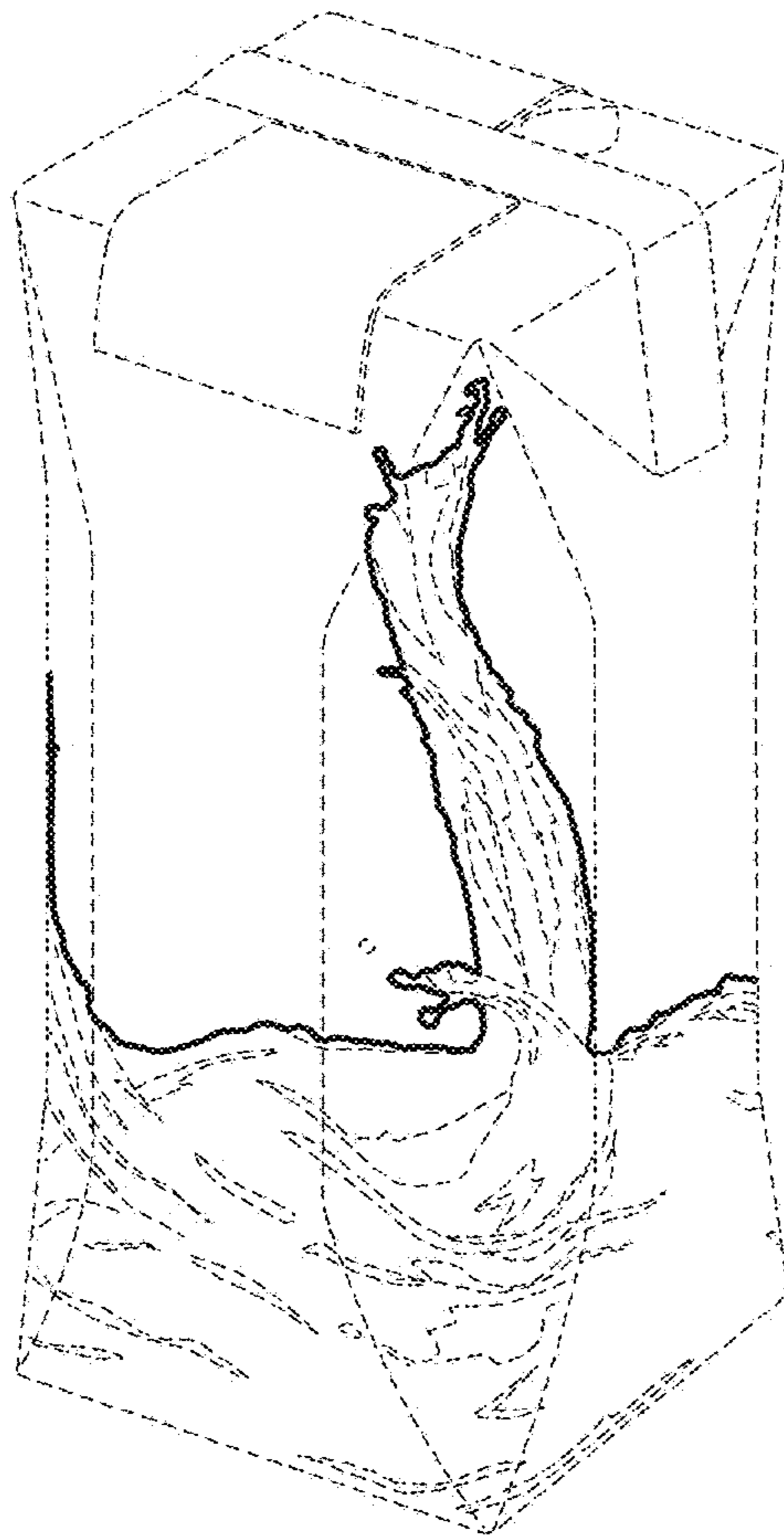
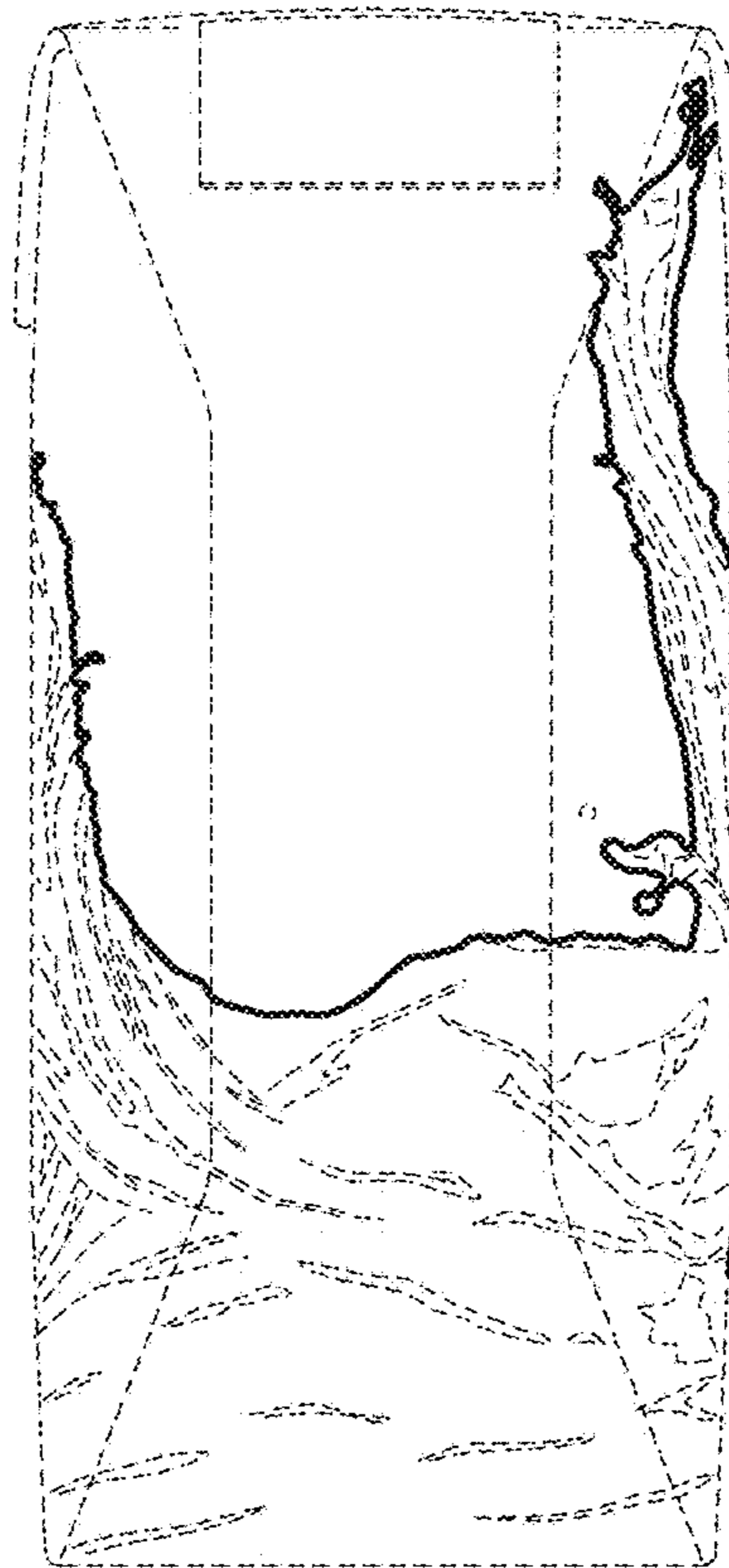

FIG. 15

FIG. 16



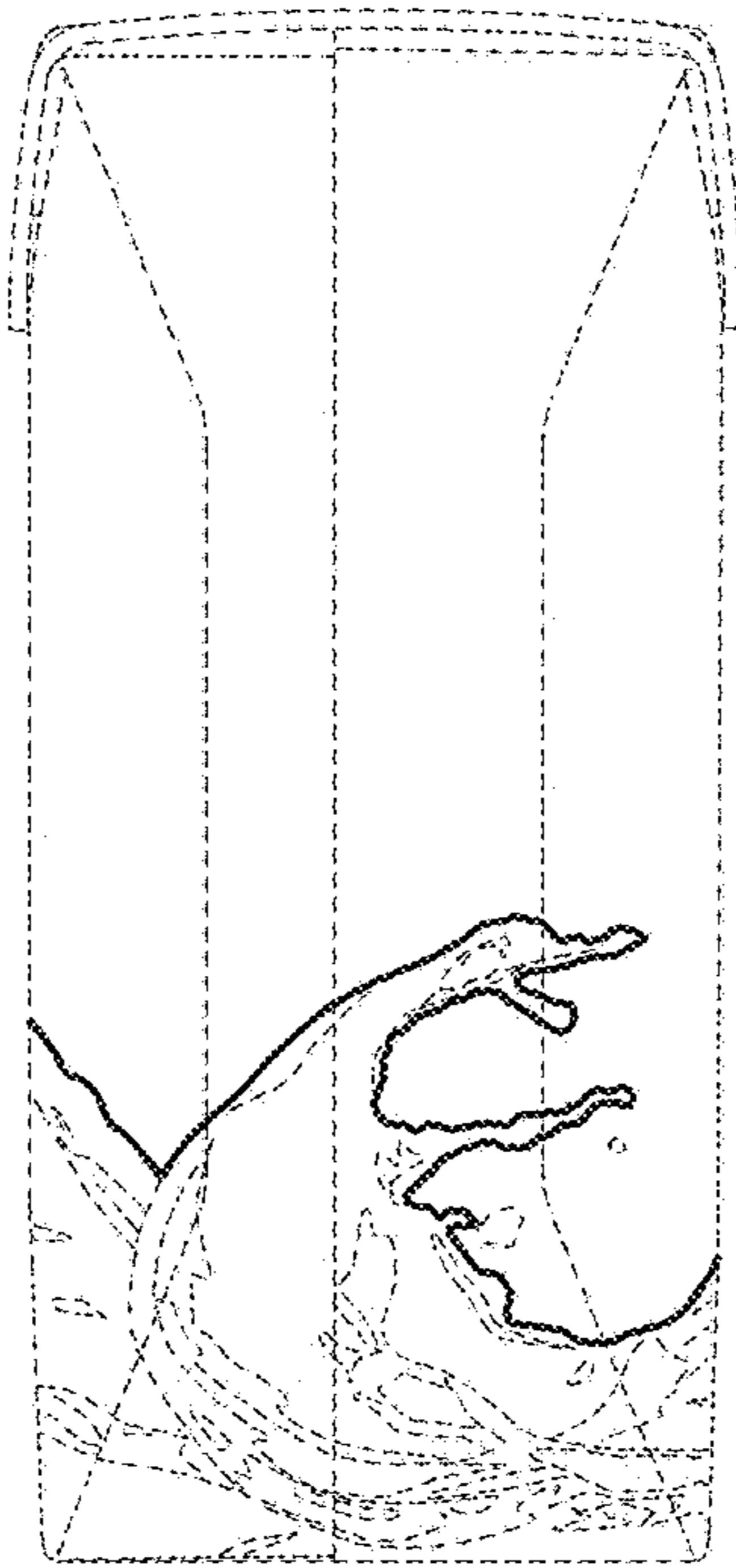

FIG. 17

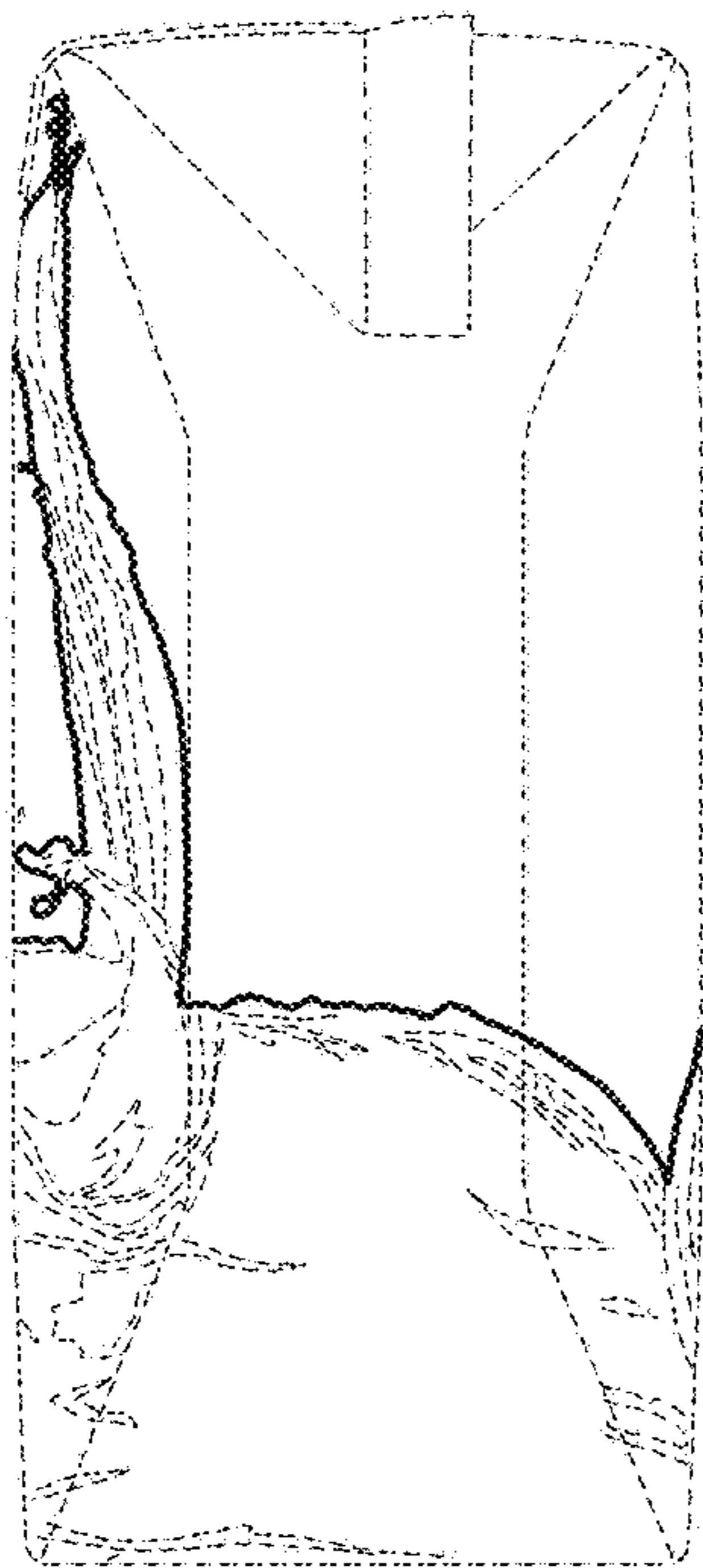

FIG. 18



FIG. 19

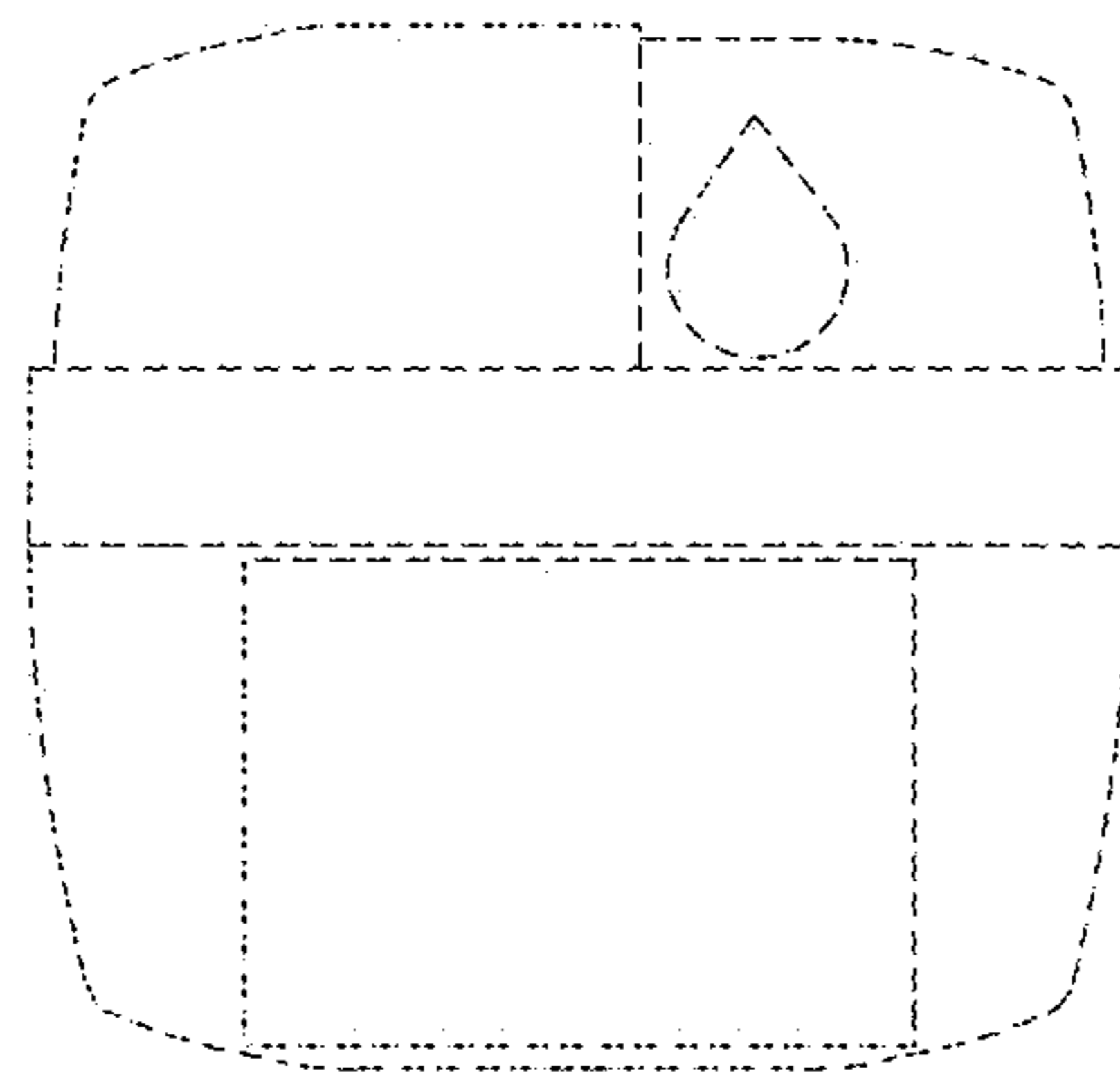

FIG. 20

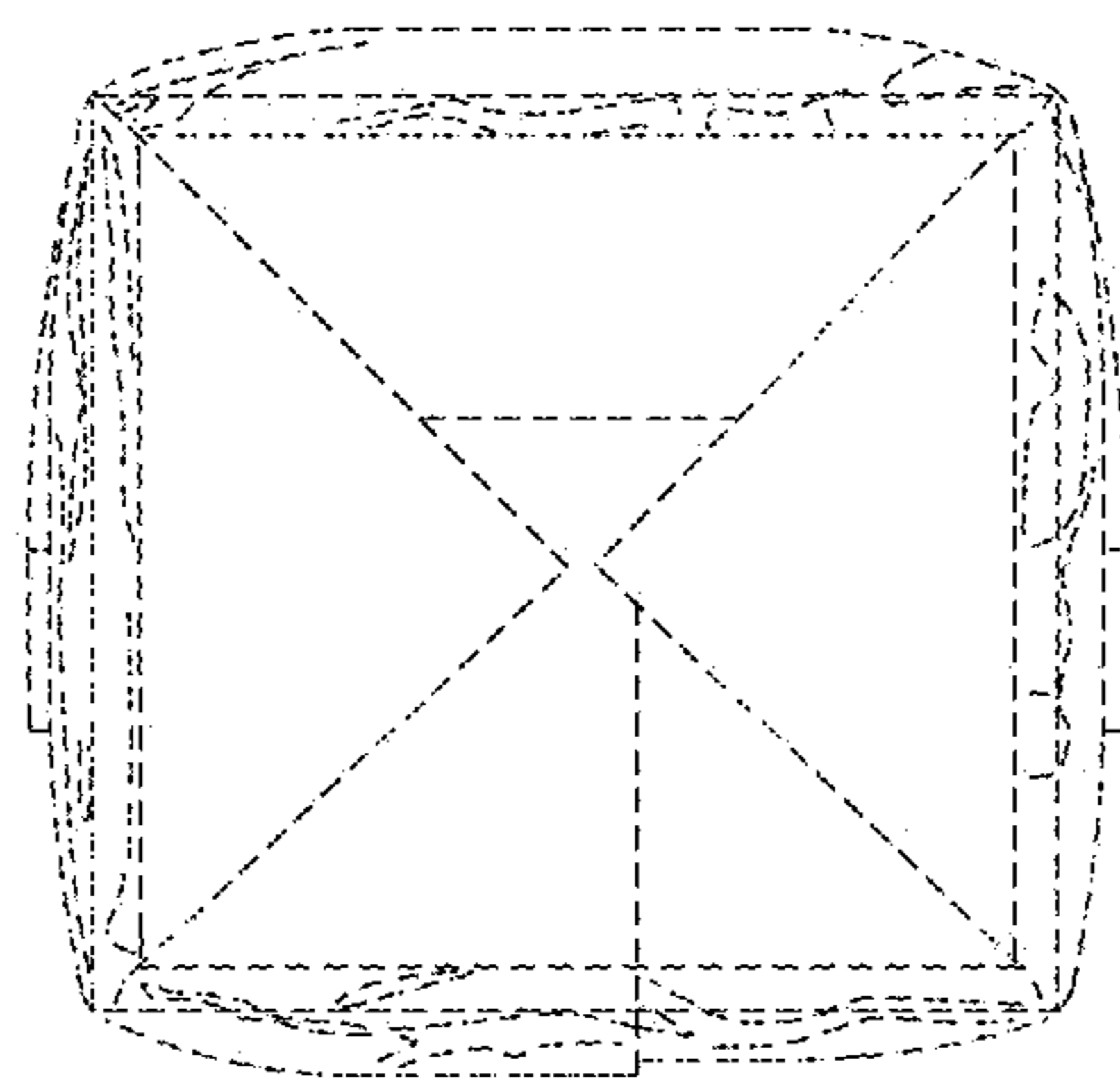

FIG. 21

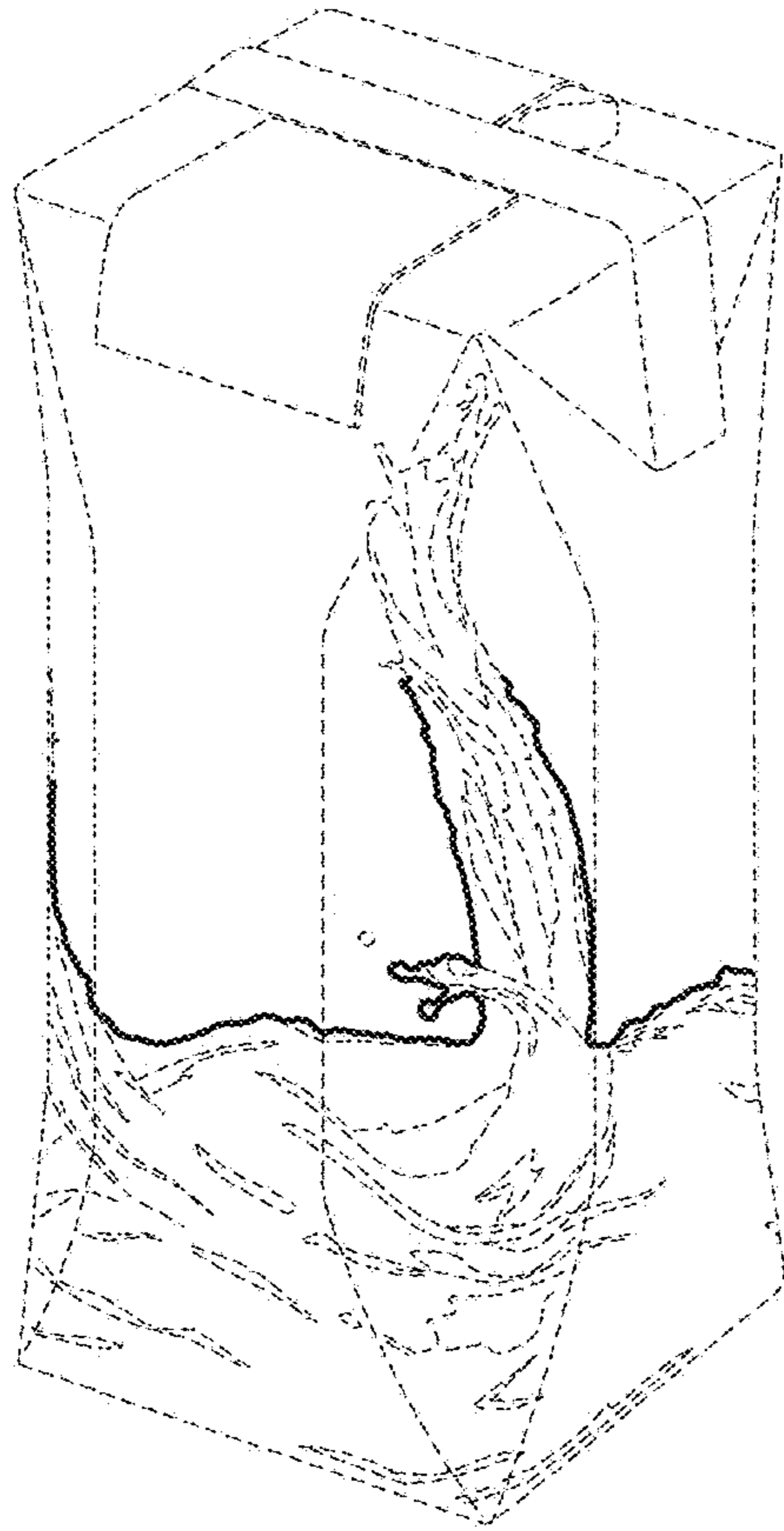

FIG. 22

FIG. 23



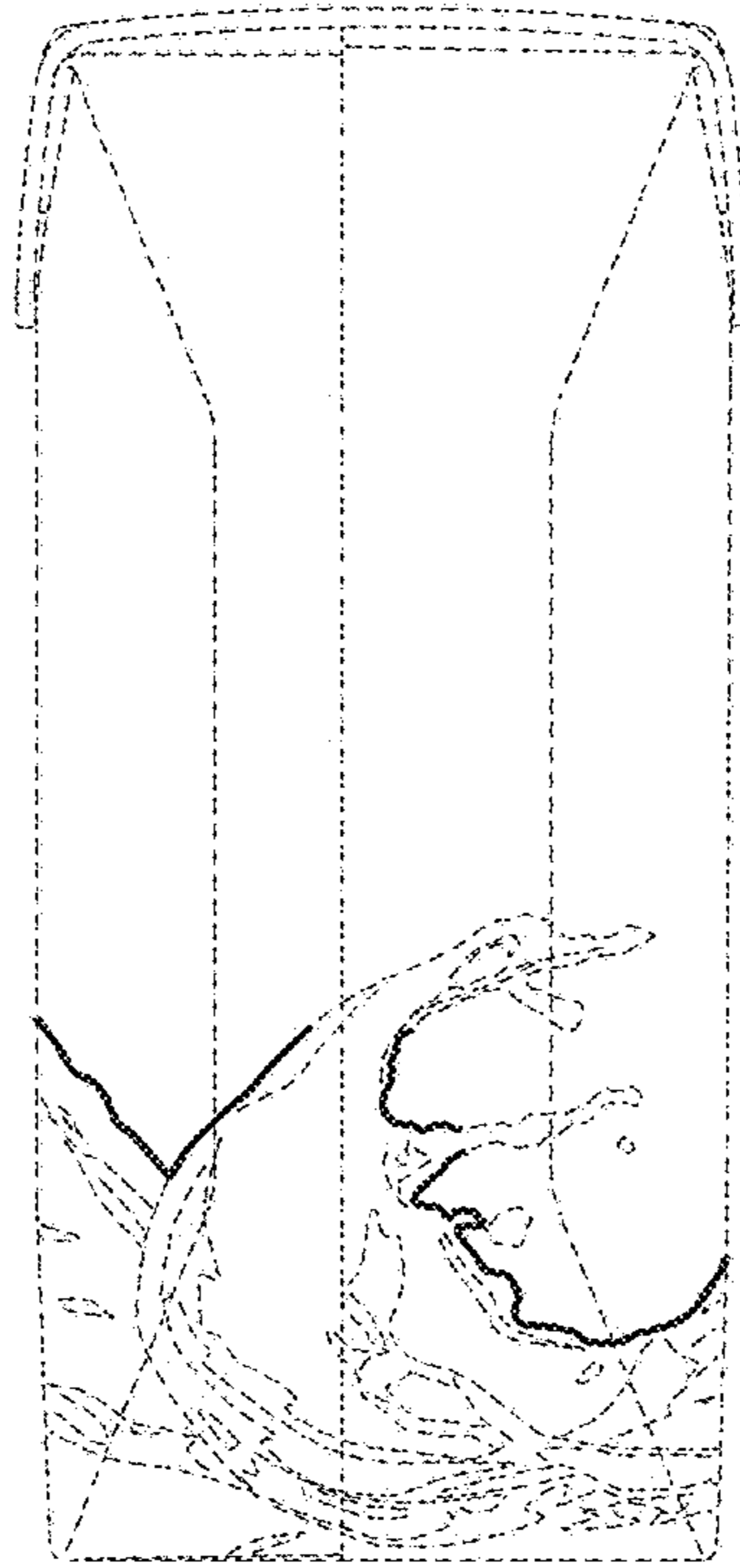

FIG. 24

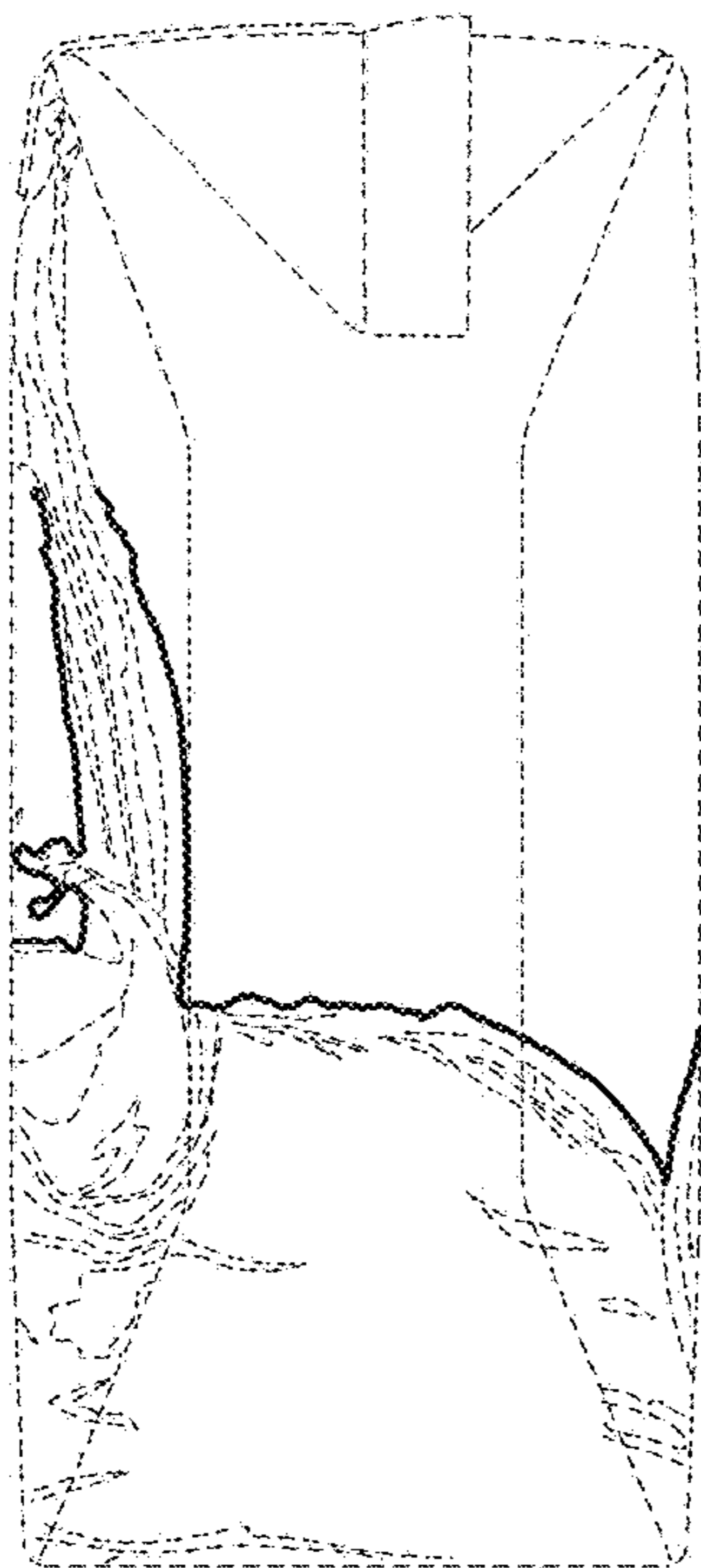

FIG. 25

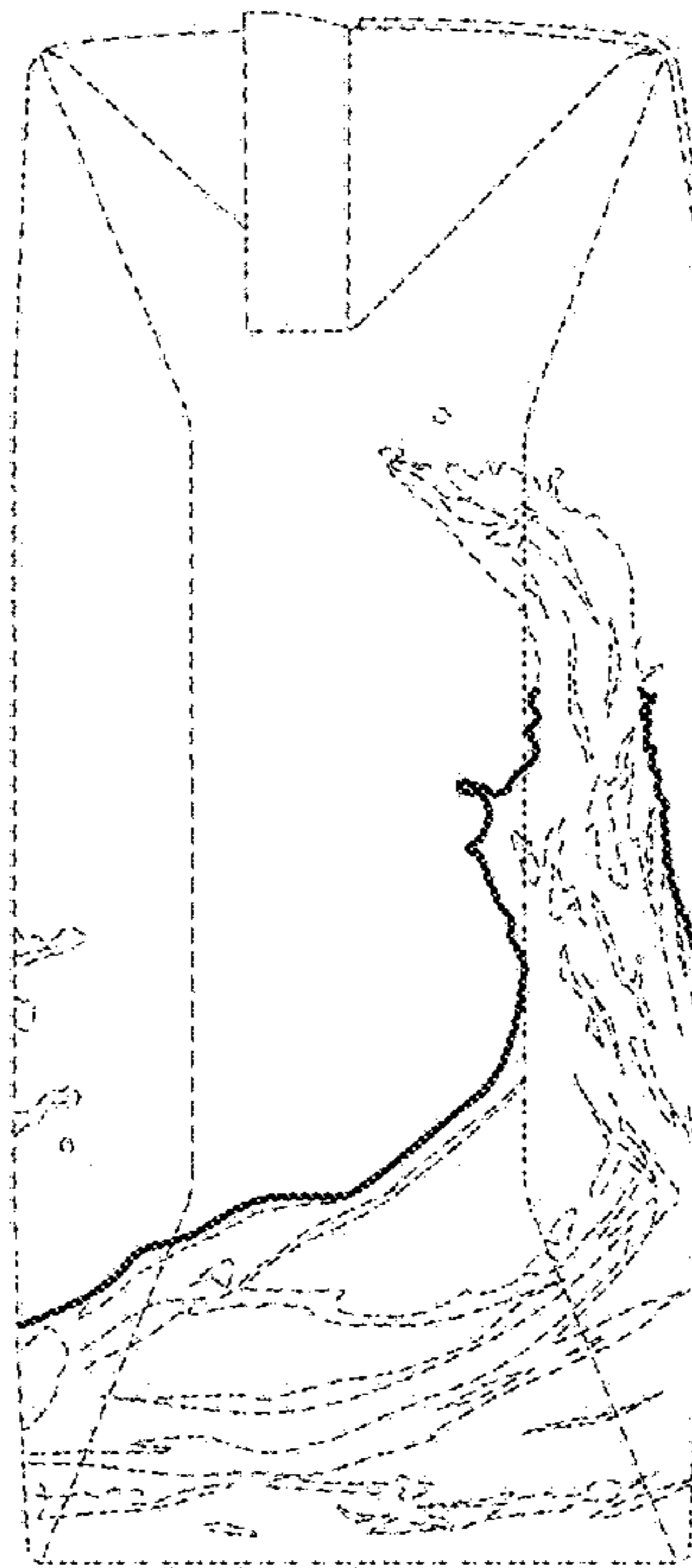

FIG. 26

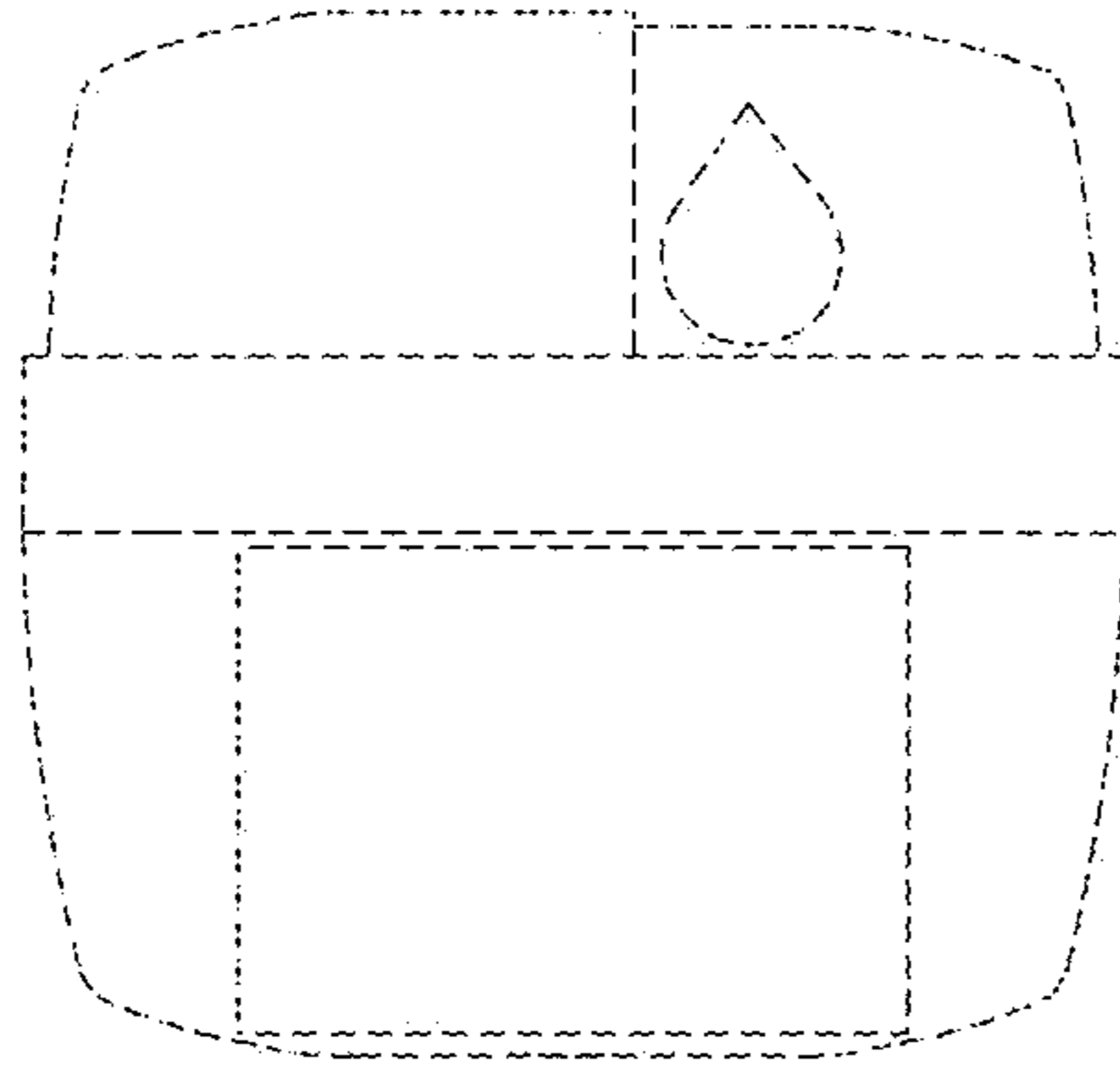

FIG. 27

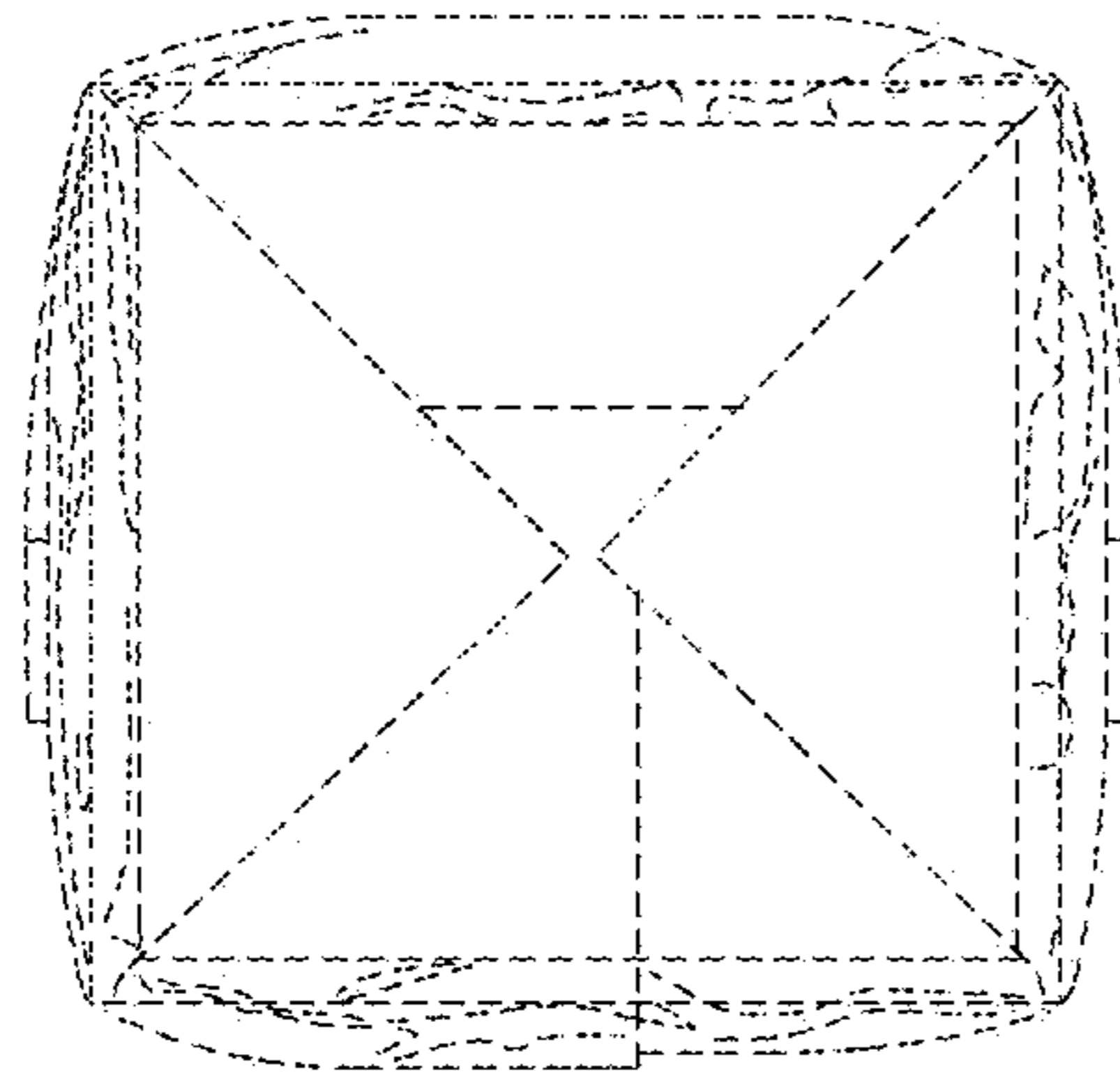

FIG. 28