



US00D835987S

(12) **United States Design Patent** (10) **Patent No.:** **US D835,987 S**
Moroni (45) **Date of Patent:** **** Dec. 18, 2018**

(54) **LIQUID CONTAINER**
(71) Applicant: **IPI S.r.l.**, San Sisto (PG) (IT)
(72) Inventor: **Luca Moroni**, Perugia (IT)
(73) Assignee: **IPI S.R.L.**, San Sisto (PG) (IT)

D652,316 S * 1/2012 Ren D9/432
D657,239 S * 4/2012 Gavrilencov D9/432
D676,742 S * 2/2013 Walter D9/434
D691,471 S * 10/2013 Walter D9/434
D697,789 S * 1/2014 Gerdes D9/417
(Continued)

(**) Term: **15 Years**
(21) Appl. No.: **29/602,483**

FOREIGN PATENT DOCUMENTS
CN 201330176535 * 5/2013
CN 201530033323 * 2/2015

(22) Filed: **May 1, 2017**

OTHER PUBLICATIONS

(30) **Foreign Application Priority Data**

Life Juices Repackaging. Online, published date Oct. 31, 2016.
Retrieved on Mar. 22, 2018 from URL: <http://georgeprobonas.com/project/life-juices-repackaging/>.
(Continued)

Nov. 3, 2016 (EM) 003446368-0009

(51) **LOC (11) Cl.** **09-03**

(52) **U.S. Cl.**
USPC **D9/432**

(58) **Field of Classification Search**
USPC D9/414-434, 442-445, 456, 457, 542,
D9/563, 600, 614-624, 648, 655, 657,
D9/658, 661, 685, 696, 697-699, 707,
D9/711, 754, 759, 772-776; D7/601,
D7/602, 709; D3/273, 276, 304, 309-313
CPC B65D 5/00; B65D 5/001; B65D 5/0015;
B65D 5/0227-5/0254; B65D 5/18; B65D
5/38; B65D 5/40; B65D 5/2033; B65D
5/48024; B65D 5/6605; B65D 1/22;
B65D 1/24; B65D 1/34; B65B 5/06
See application file for complete search history.

Primary Examiner — Karen S Acker
Assistant Examiner — Omeed Agilee
(74) *Attorney, Agent, or Firm* — Lucas & Mercanti, LLP

(57) **CLAIM**

The ornamental design for a liquid container, as shown and described.

DESCRIPTION

FIG. 1 is a front view thereof;
FIG. 2 is a first side view thereof;
FIG. 3 is a second side view thereof;
FIG. 4 is a bottom view thereof;
FIG. 5 is a top view thereof;
FIG. 6 is a front perspective view thereof; and,
FIG. 7 is a back perspective view thereof.
The evenly spaced broken lines in FIGS. 4-7 depict environmental subject matter that forms no part of the claimed design. The dot-dash-dot broken lines in FIG. 4 depict the boundaries of the claim and form no part thereof. Lines and areas within those boundaries form no part of the claimed design.

(56) **References Cited**

U.S. PATENT DOCUMENTS

3,795,359 A * 3/1974 Rausing B65D 5/065
229/120
6,929,171 B1 * 8/2005 Thiersch B65D 5/029
229/108
D562,129 S * 2/2008 Kortsmi D9/430
D596,027 S * 7/2009 Kalberer D9/432
D598,745 S * 8/2009 Bohache D9/430

1 Claim, 7 Drawing Sheets

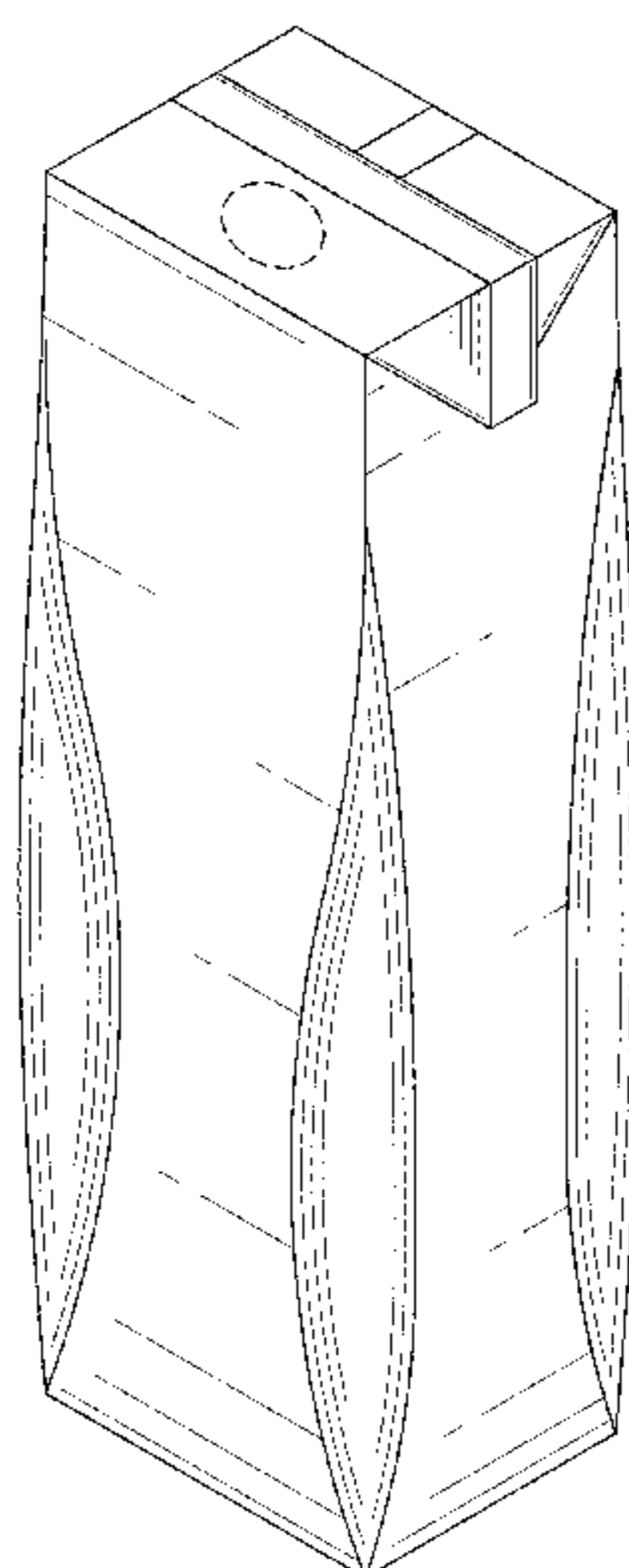

(56)

References Cited

U.S. PATENT DOCUMENTS

D714,638	S	*	10/2014	Mohn	D9/432
D715,640	S	*	10/2014	Okezawa	D9/430
D728,364	S	*	5/2015	Baker	D9/432
D734,144	S	*	7/2015	Sanfilippo	D9/416
D748,470	S	*	2/2016	Mohn	D9/432
D754,534	S	*	4/2016	Sanfilippo	D9/432
D764,283	S	*	8/2016	Mohn	D9/432
D764,284	S	*	8/2016	Mohn	D9/432
D795,686	S	*	8/2017	Mohn	D9/417
2008/0296359	A1	*	12/2008	Kortsmit	B65D 5/067 229/136

OTHER PUBLICATIONS

CHI Limited Introduces Chivita Active Vegetable, Fruit Nectar into Nigerian Market. Online, published date May 5, 2016. Retrieved on Mar. 22, 2018 from URL: <http://www.brandessencenigeria.com/chi-limited-introduces-chivita-active-vegetable-fruit-nectar-into-nigerian-market/>.*

* cited by examiner

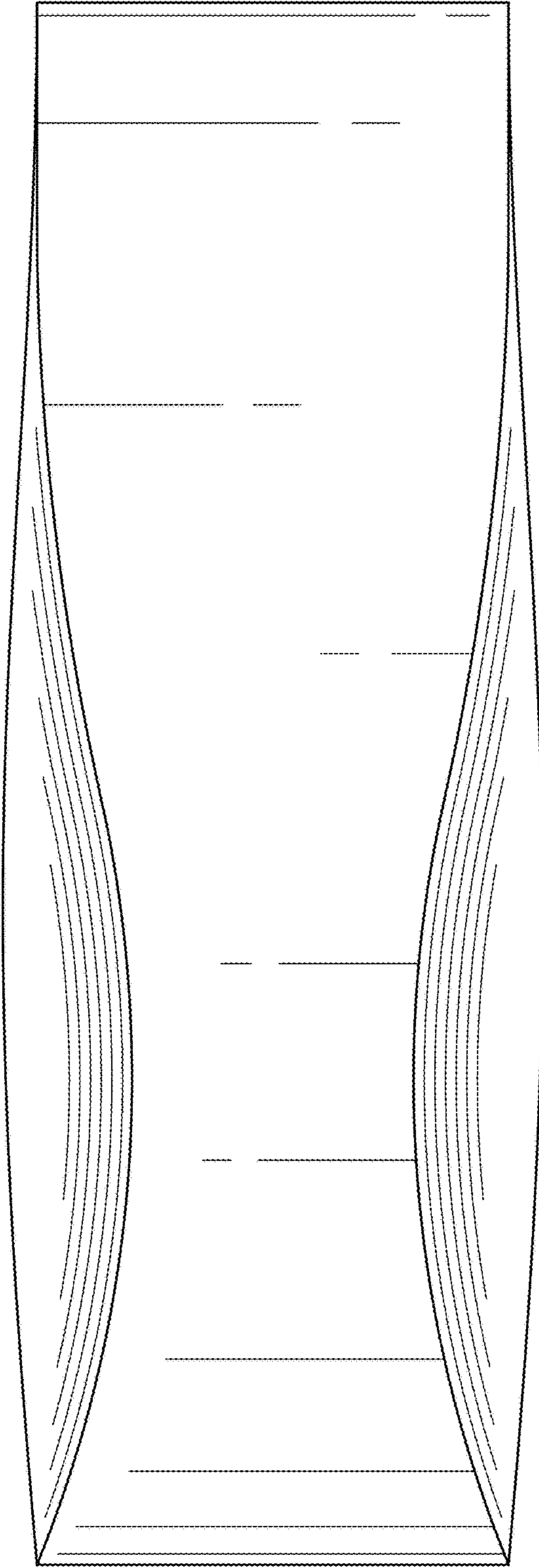

FIG. 1

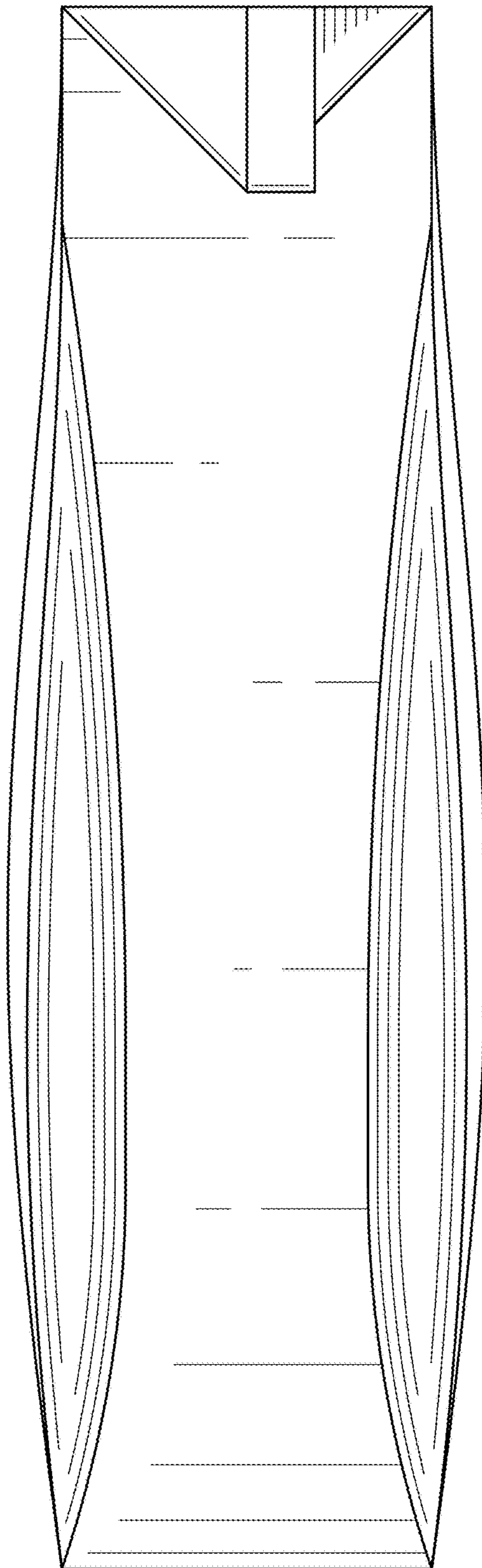

FIG. 2

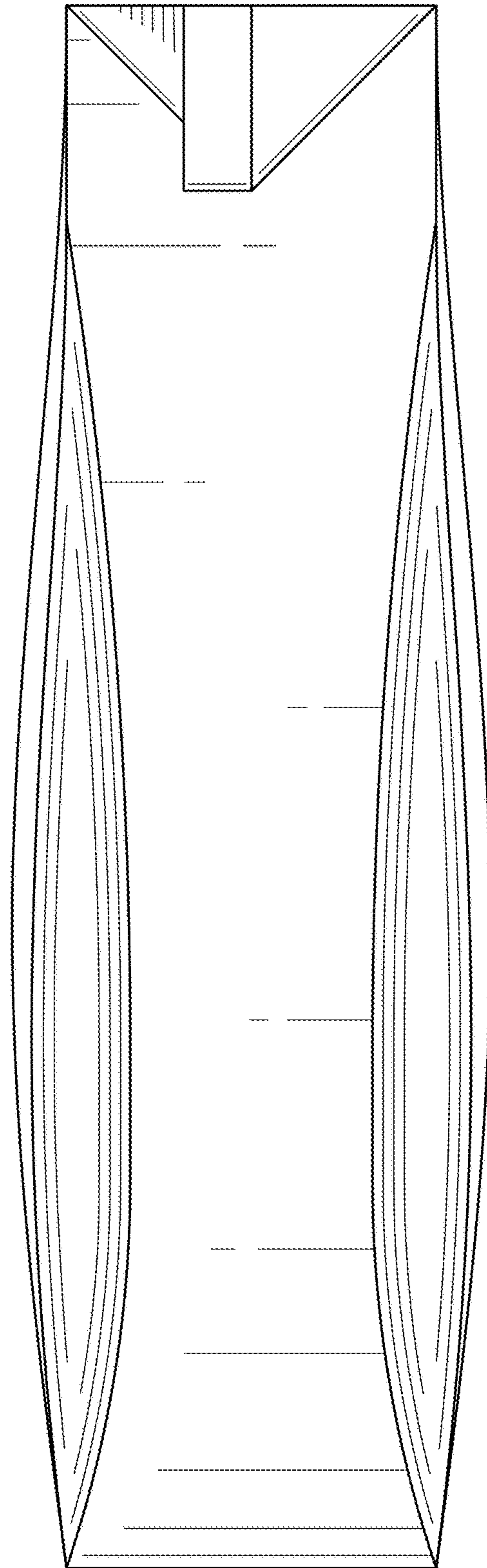

FIG. 3

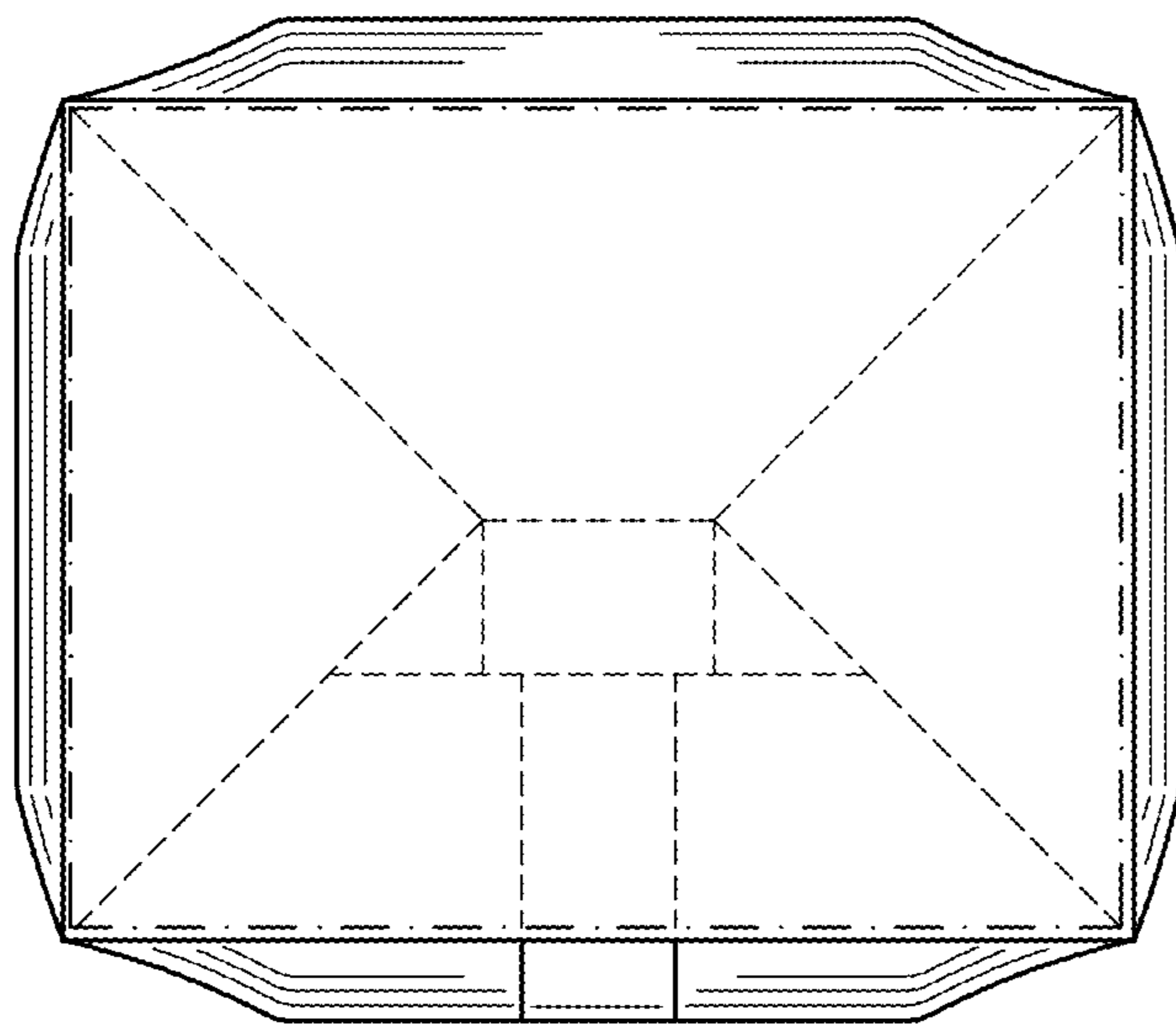

FIG. 4

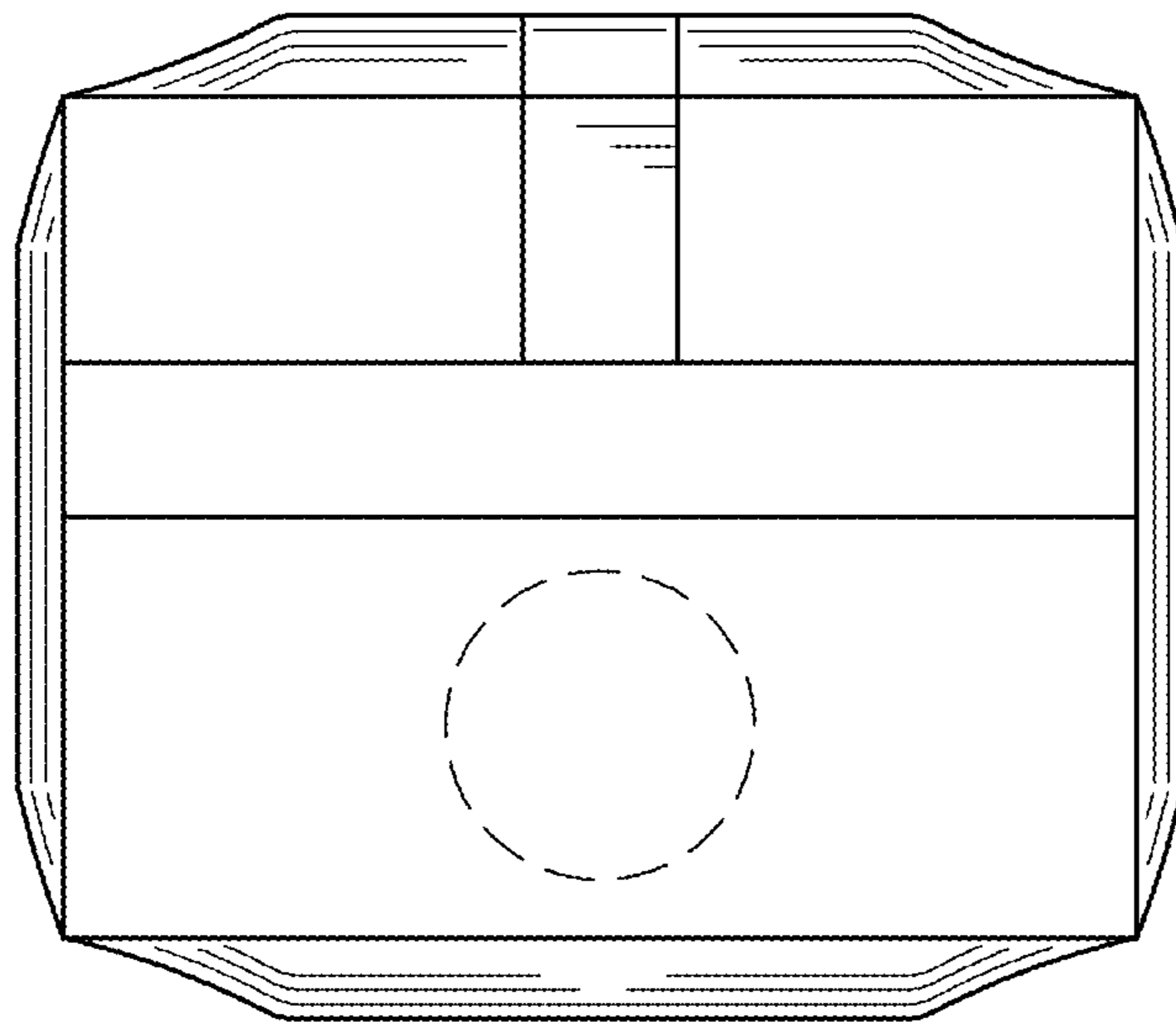

FIG. 5

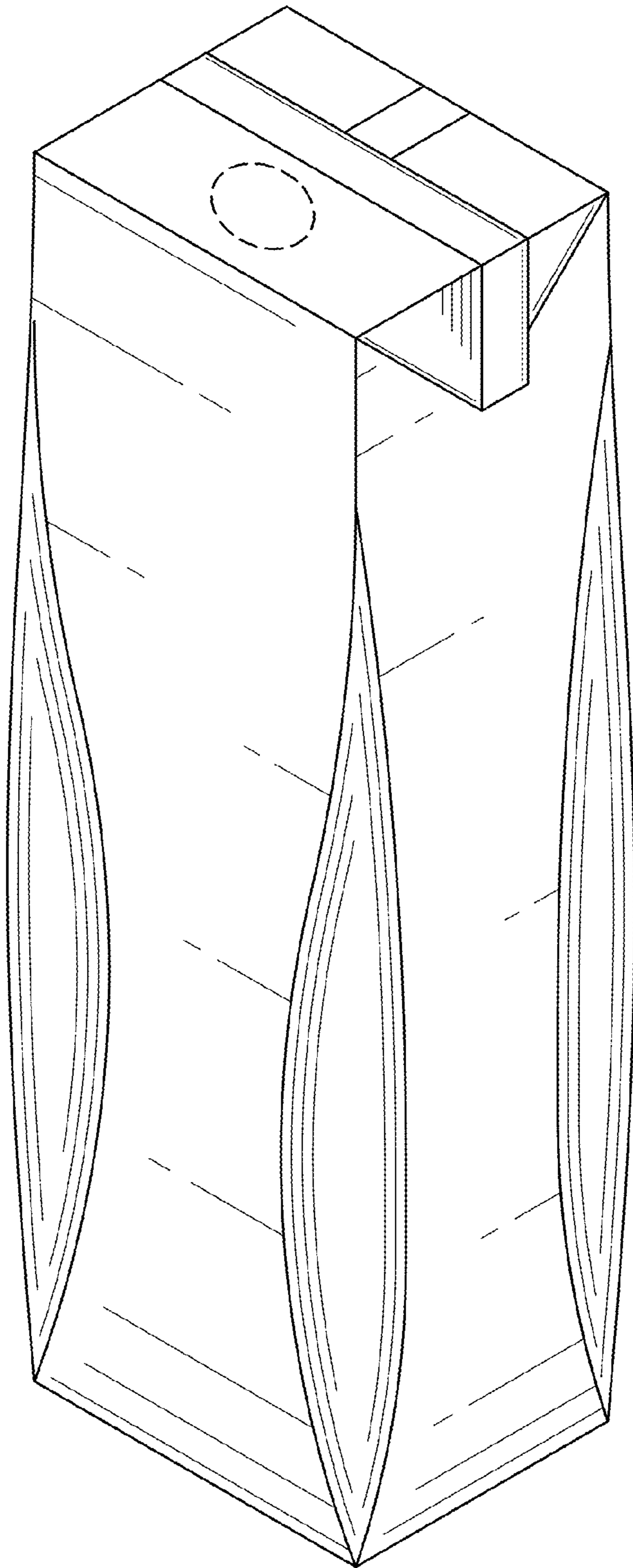

FIG. 6

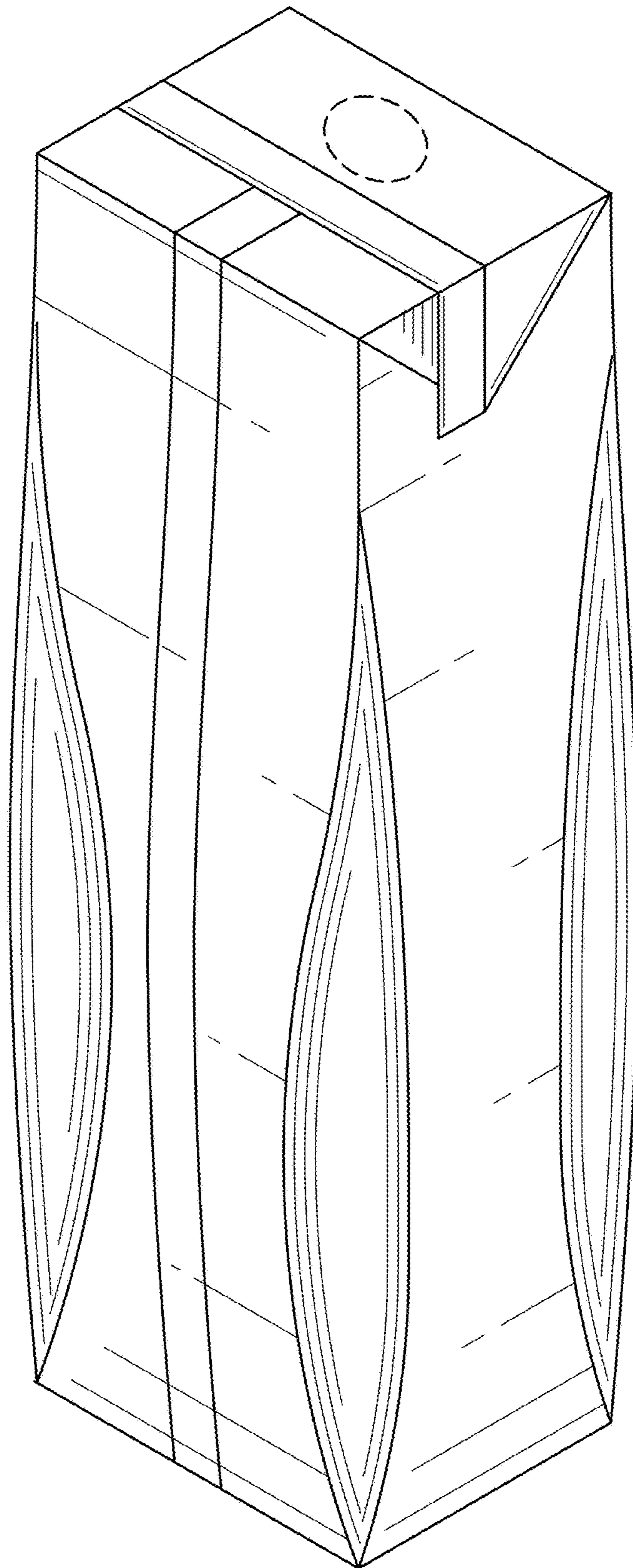

FIG. 7