



US00D835986S

(12) **United States Design Patent** (10) **Patent No.:** **US D835,986 S**
Stimpson (45) **Date of Patent:** **** Dec. 18, 2018**

(54) **PACKAGING**

(71) Applicant: **LIC INC LIMITED**, Rugby (GB)

(72) Inventor: **Harry Stimpson**, Welford (GB)

(**) Term: **15 Years**

(21) Appl. No.: **35/502,851**

(22) Filed: **Mar. 17, 2017**

(80) **Hague Agreement Data**

Int. Filing Date: **Mar. 17, 2017**

Int. Reg. No.: **DM/095633**

Int. Reg. Date: **Mar. 17, 2017**

Int. Reg. Pub. Date: **Apr. 28, 2017**

(51) **LOC (11) Cl.** **09-03**

(52) **U.S. Cl.**

USPC **D9/430**

CPC **B65D 5/16** (2013.01)

(58) **Field of Classification Search**

USPC D9/414-433, 711, 715, 721, 737;
206/315.9, 315.91, 592, 775, 777, 779,
206/780; 220/101, 103.2, 103.3, 108,
220/115, 116, 121, 122, 162.1,
220/162.4-162.6

CPC B65D 5/4204; B65D 2571/00728; B65D
5/029; B65D 5/16; B65D 2571/00716;
B65D 5/008; B65D 2571/00549; B65D
5/5021; B65D 5/2028; B65D 5/0254;
B65D 75/14; B65D 2571/0029; B65D
5/02; B65D 5/5035; B65D 81/113; B65D
5/42; B65D 5/5007; B65D 5/443; B65D
5/5016; B65D 81/133; B65D 5/2033;
B65D 25/54; B65D 73/0085; B65D
2571/00283; B65D 5/2042; B65D 75/50;
B65D 81/025; B65D 85/00; B65D 5/00;
B65D 5/5026; B65D 5/48048; B65D
75/522; B65D 15/22; B65D 77/02; B65D
85/1036; B65D 71/22; B65D 75/28;
B65D 5/2061; B65D 77/003; B65D
2519/00019

See application file for complete search history.

(56) **References Cited**

U.S. PATENT DOCUMENTS

D30,427 S *	3/1899	Becton	D9/759
D186,560 S *	11/1959	Bruening	D9/737
D253,456 S *	11/1979	Payne	D9/426
D266,631 S *	10/1982	Crutchfield	D3/294
D266,743 S *	11/1982	Brown	D9/416
D276,381 S *	11/1984	Nagle	D3/294
D308,826 S *	6/1990	Cyr	D9/426
D318,426 S *	7/1991	Vroonen	D9/418
D401,765 S *	12/1998	Soutullo	D4/199
D468,638 S *	1/2003	Nogami	D9/423
D518,370 S *	4/2006	Vanhoutte	D9/418
D602,352 S *	10/2009	Pendergrass	D9/424

(Continued)

Primary Examiner — Richard E Chilcot

(57) **CLAIM**

The ornamental design for packaging, as shown and described.

DESCRIPTION

- 1. Packaging
- 1.1 : Perspective
- 1.2 : Perspective view when open
- 1.3 : Front
- 1.4 : Back
- 1.5 : Right
- 1.6 : Left
- 1.7 : Bottom
- 1.8 : Top
- 1.9 : Unfolded plan view of insert
- 1.10 : Folded perspective view of insert
- 1.11 : side view of folded insert
- 1.12 : opposite side view of folded insert
- 1.13 : Insert-plan view from top
- 1.14 : Insert-plan view from bottom

The broken lines on the sides, top and bottom of the packaging represent functional and environmental aspects of the product and form no part of the claimed design.

1 Claim, 14 Drawing Sheets

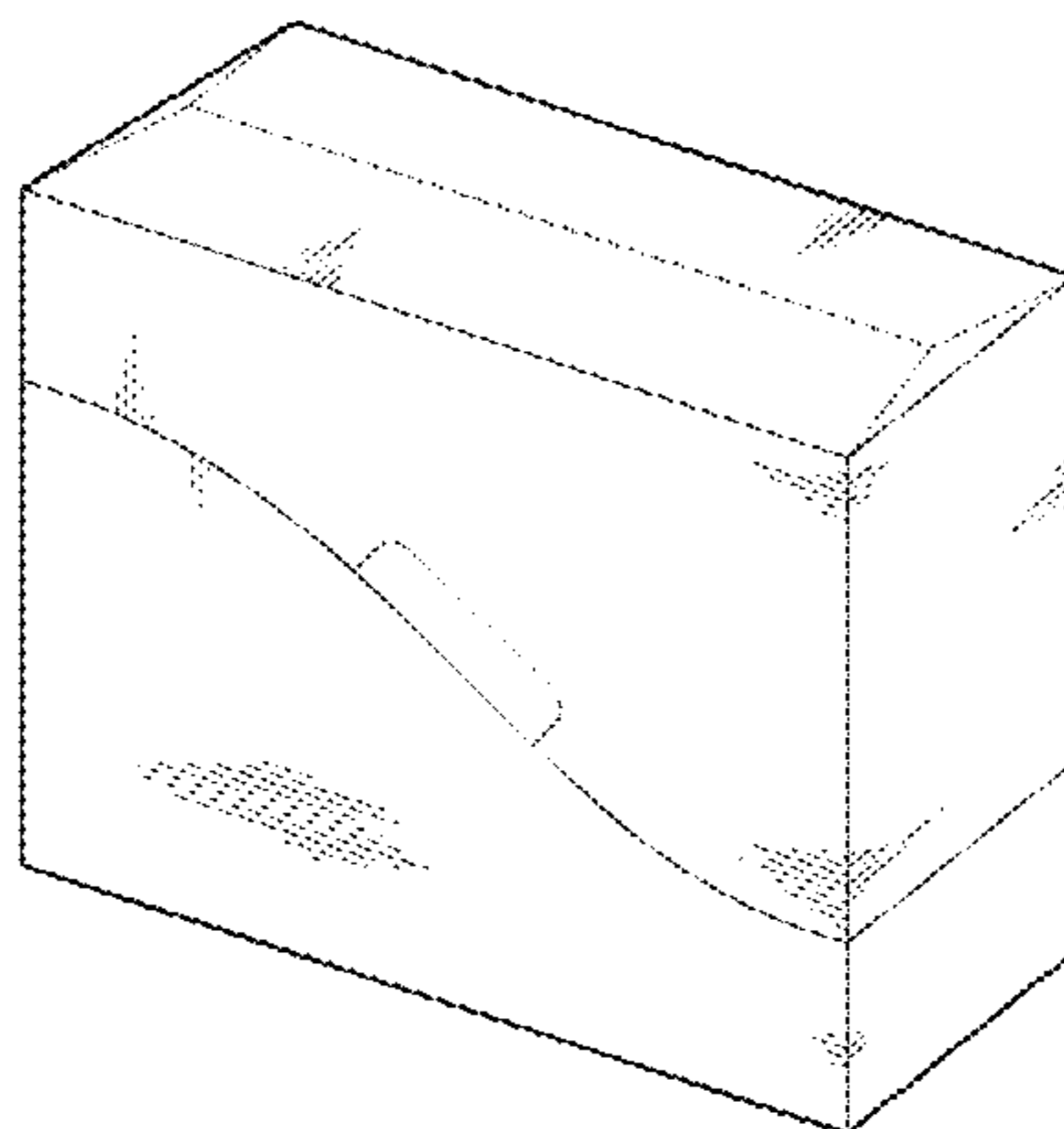

(56)

References Cited

U.S. PATENT DOCUMENTS

D618,998 S *	7/2010	Pendergrass	D9/424
D671,677 S *	11/2012	Wu	D27/189
D671,678 S *	11/2012	Wu	D27/189
D676,740 S *	2/2013	Golota	D9/420
D685,264 S *	7/2013	Lal	D9/430
D691,882 S *	10/2013	Barbieri	D9/430
D715,640 S *	10/2014	Okezawa	D9/430
D729,056 S *	5/2015	She	D9/420
D729,057 S *	5/2015	She	D9/420
D764,272 S *	8/2016	Hoglund	D9/420
D778,150 S *	2/2017	Kahawaiolaa	D9/416
D789,782 S *	6/2017	Kahawaiolaa	D9/414
D792,213 S *	7/2017	Schmal	B65D 71/10 D9/430
D806,531 S *	1/2018	Fan	D9/418
D808,793 S *	1/2018	Angeloni	D9/420

* cited by examiner

1.1

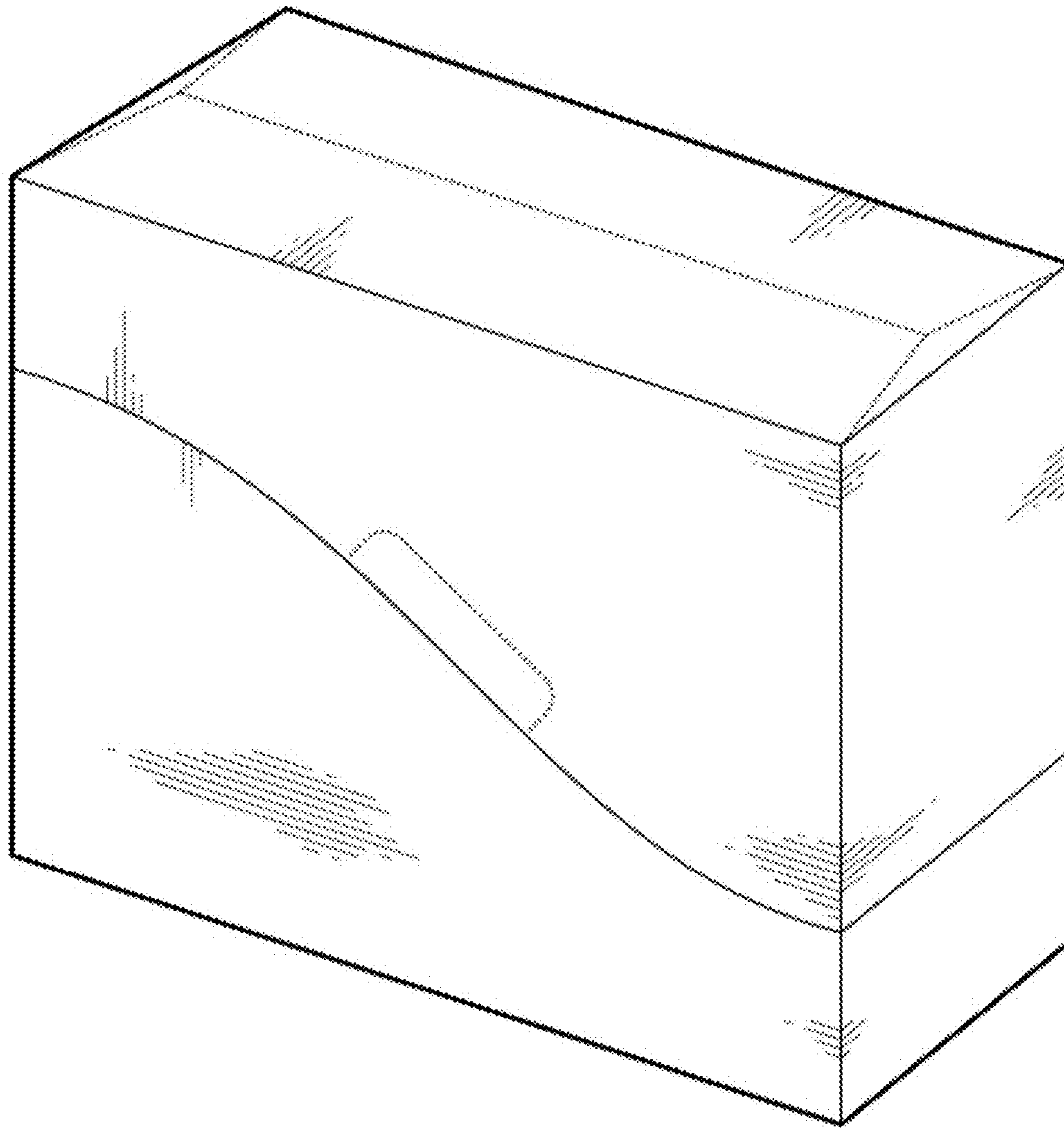

1.2

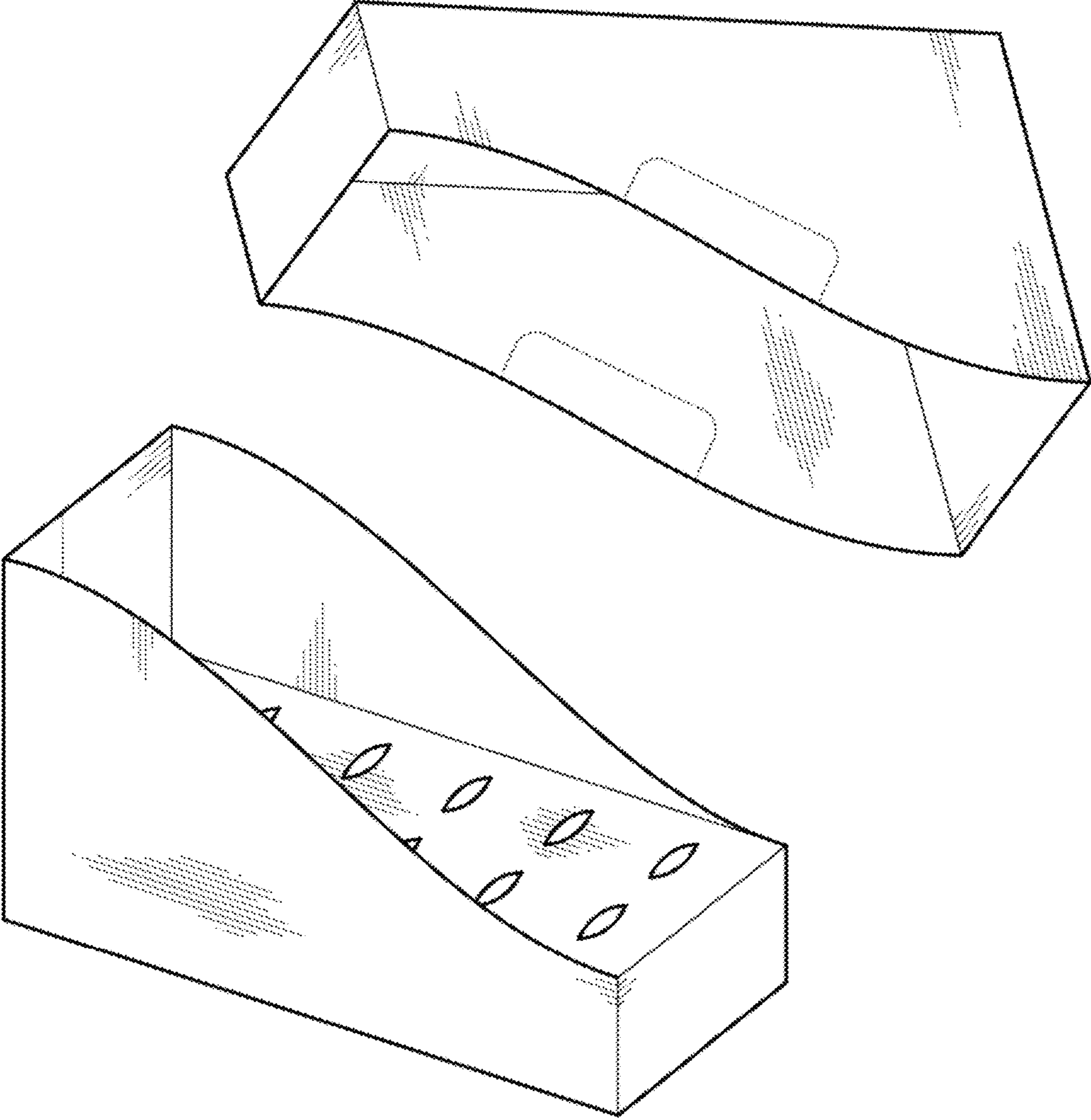

1.3

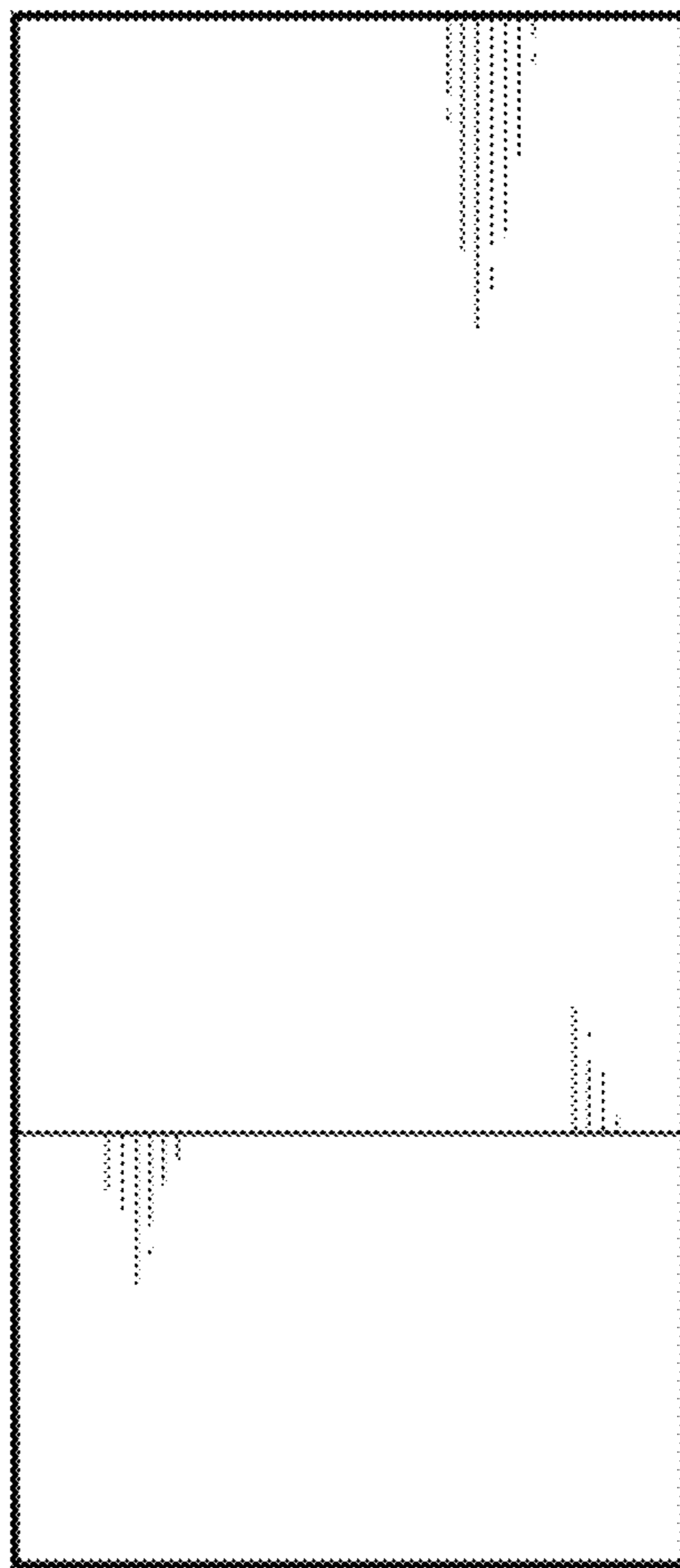

1.4

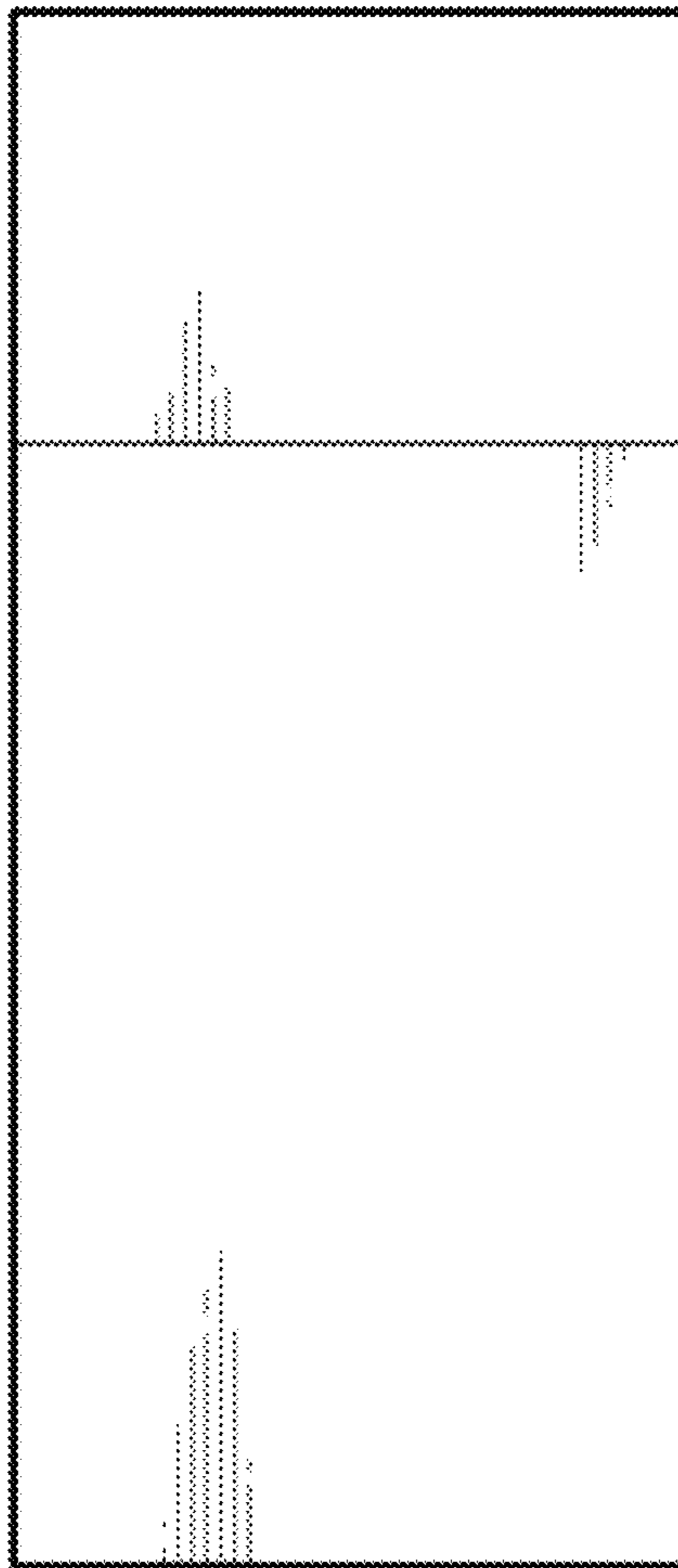

1.5

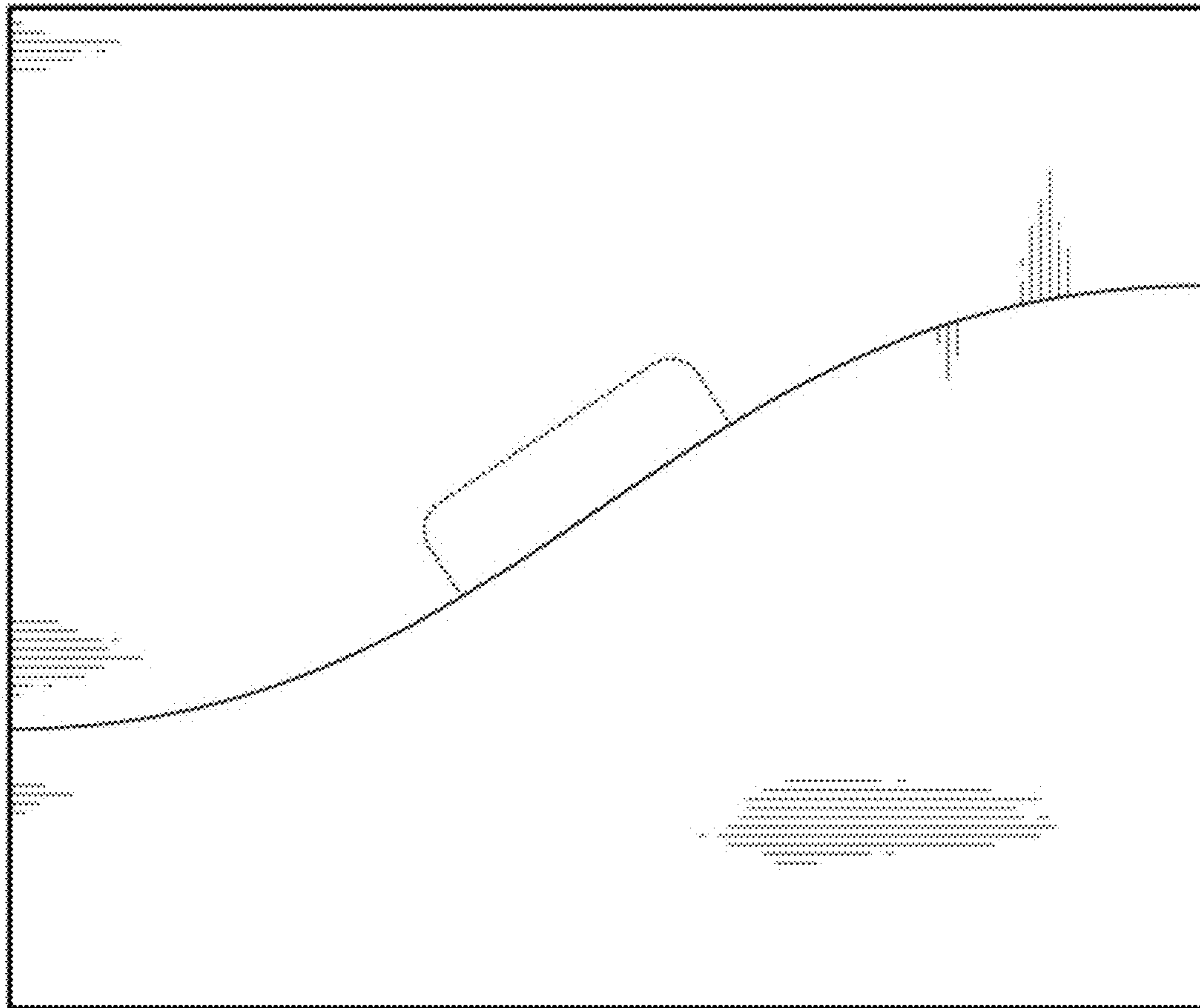

1.6

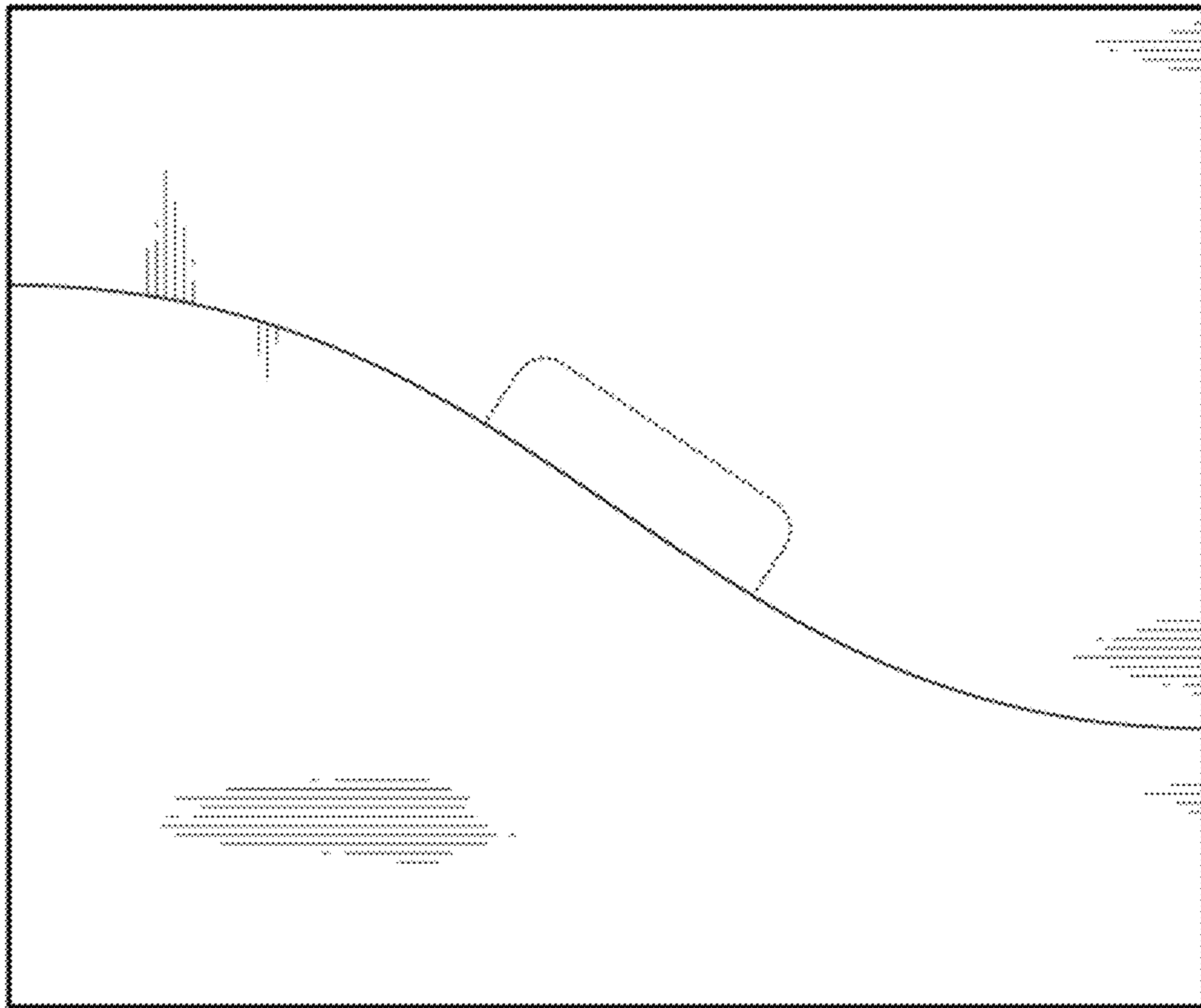

1.7

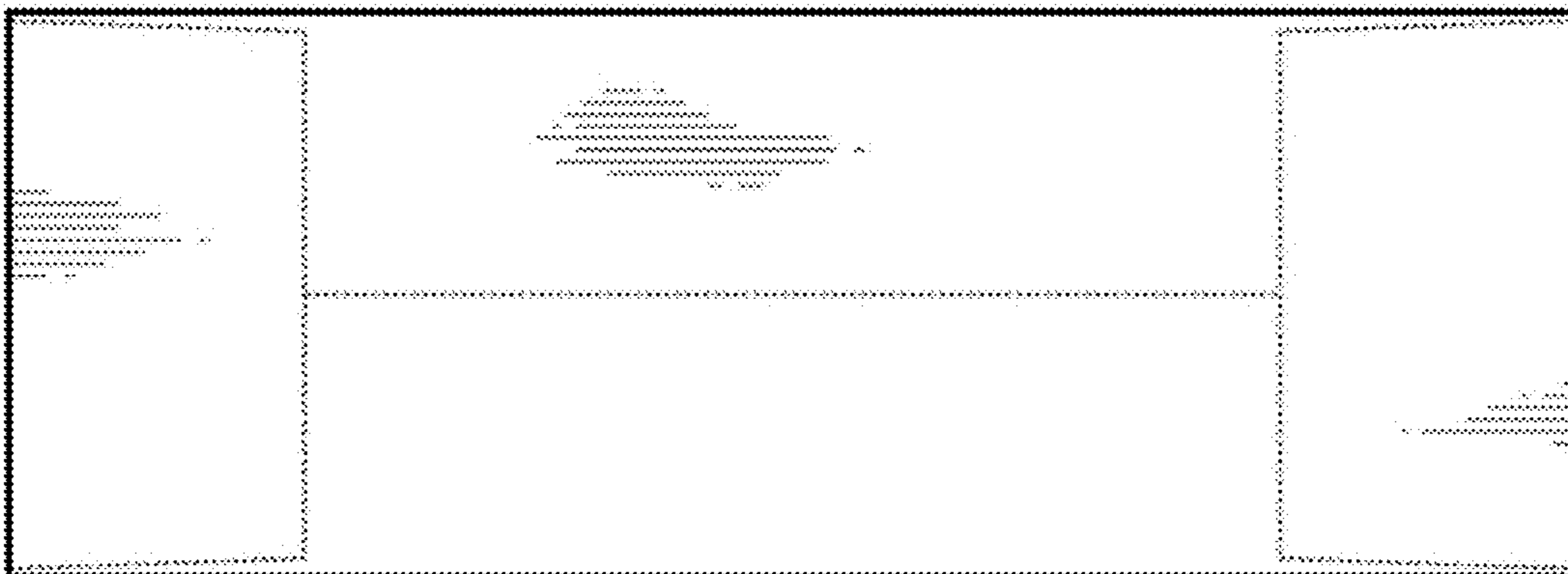

1.8

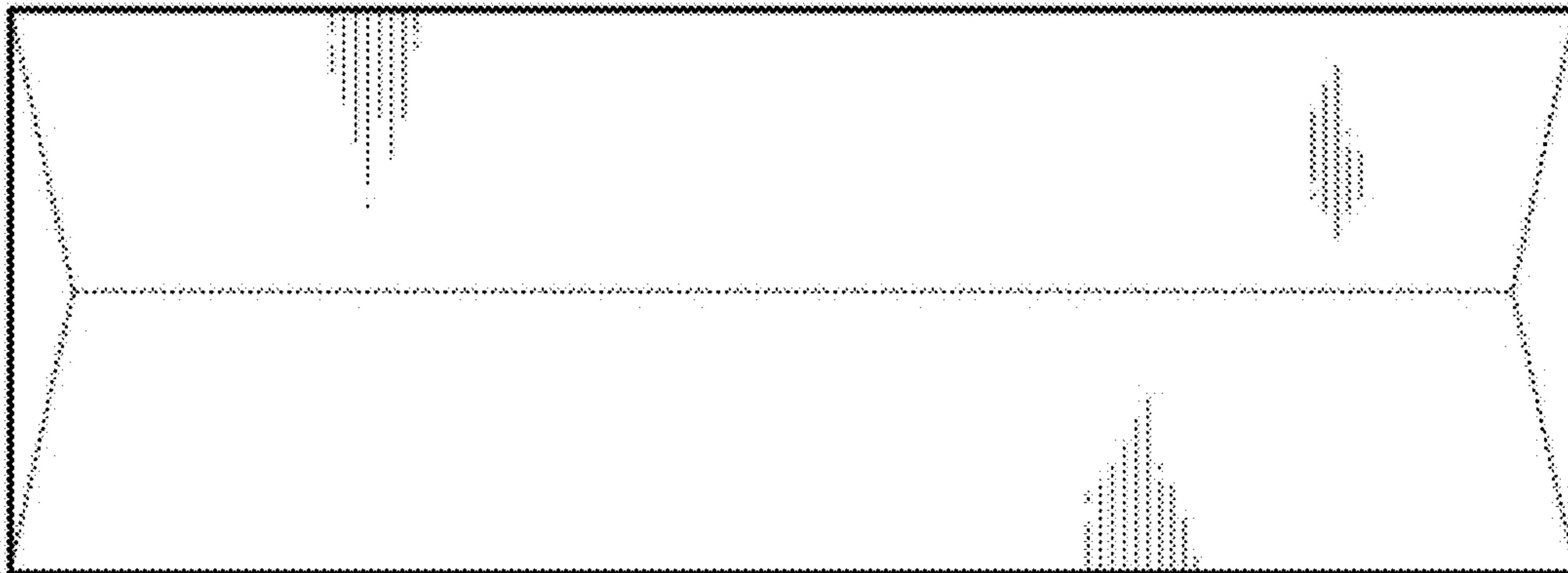

1.9

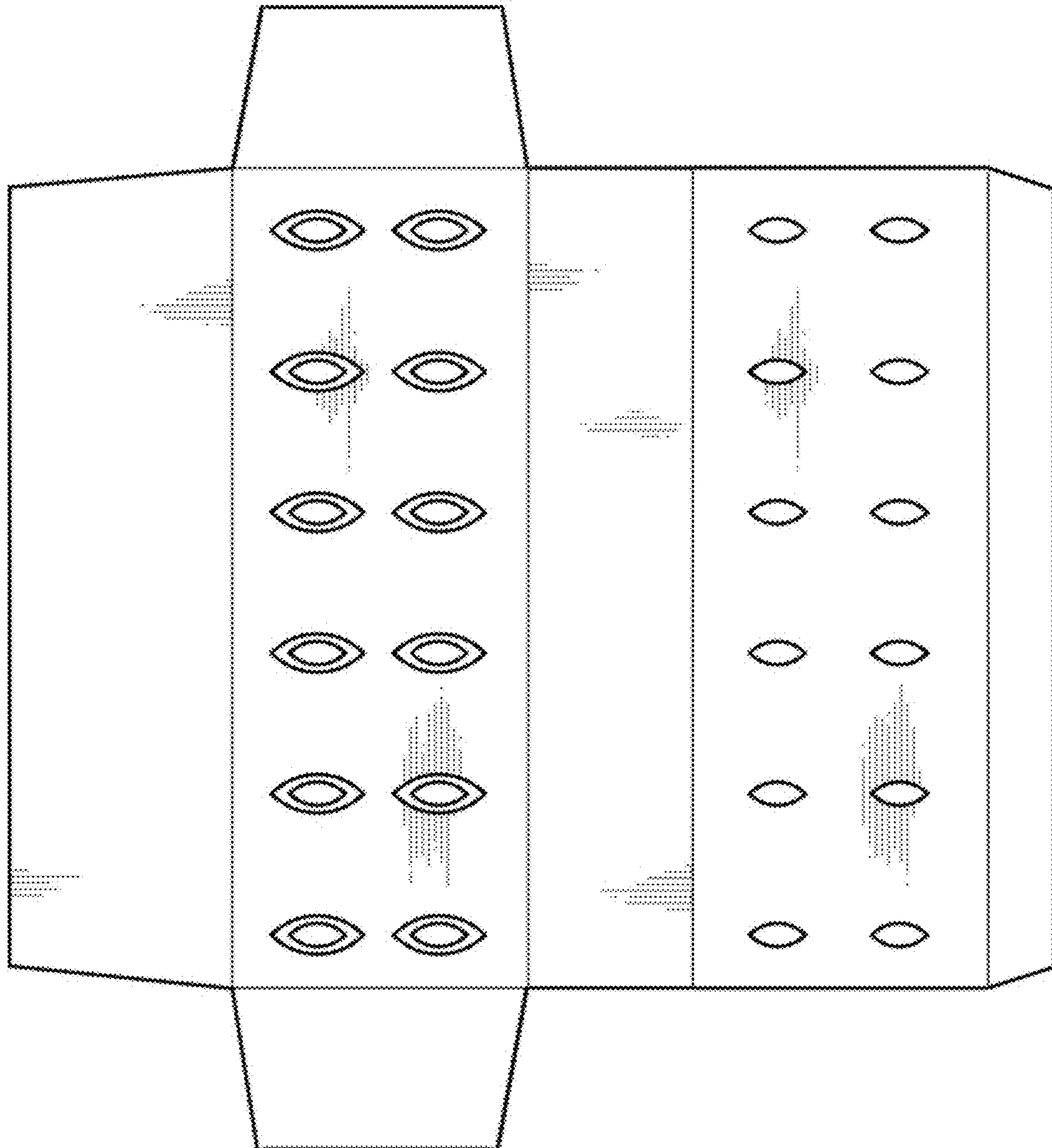

1.10

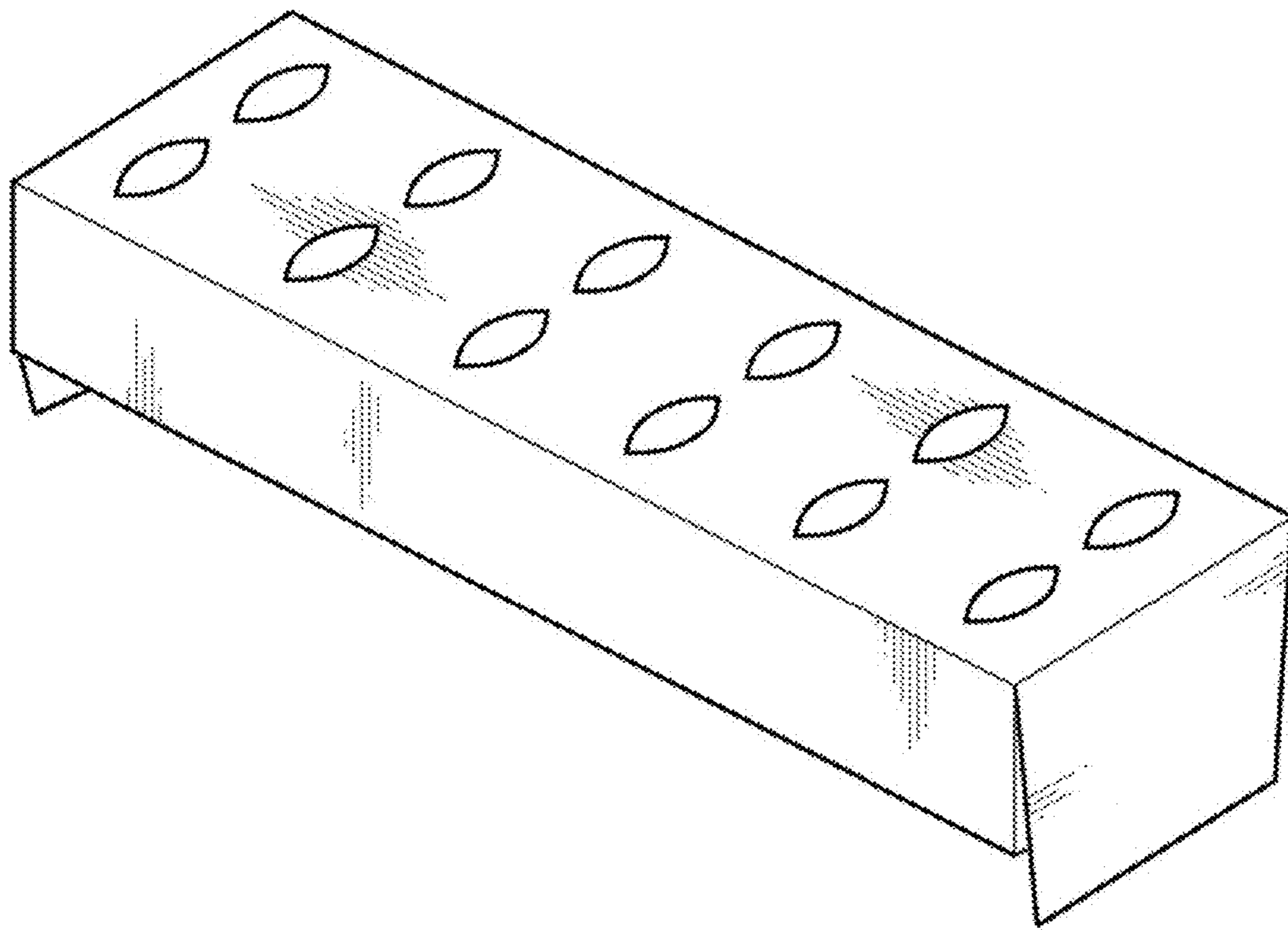

1.11

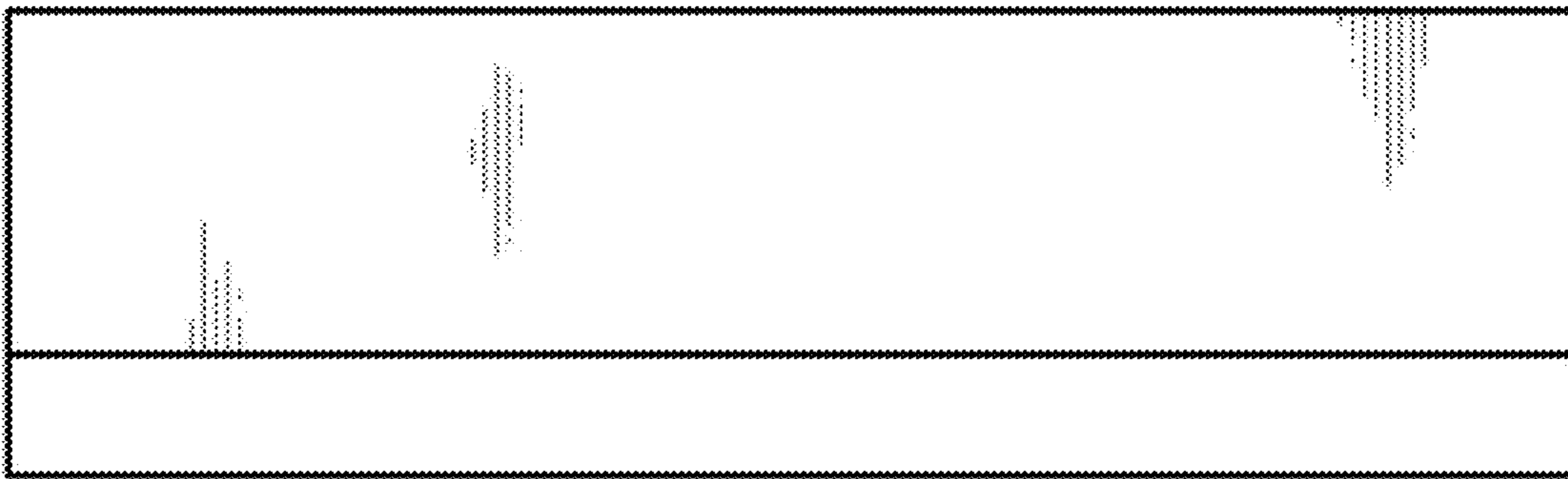

1.12

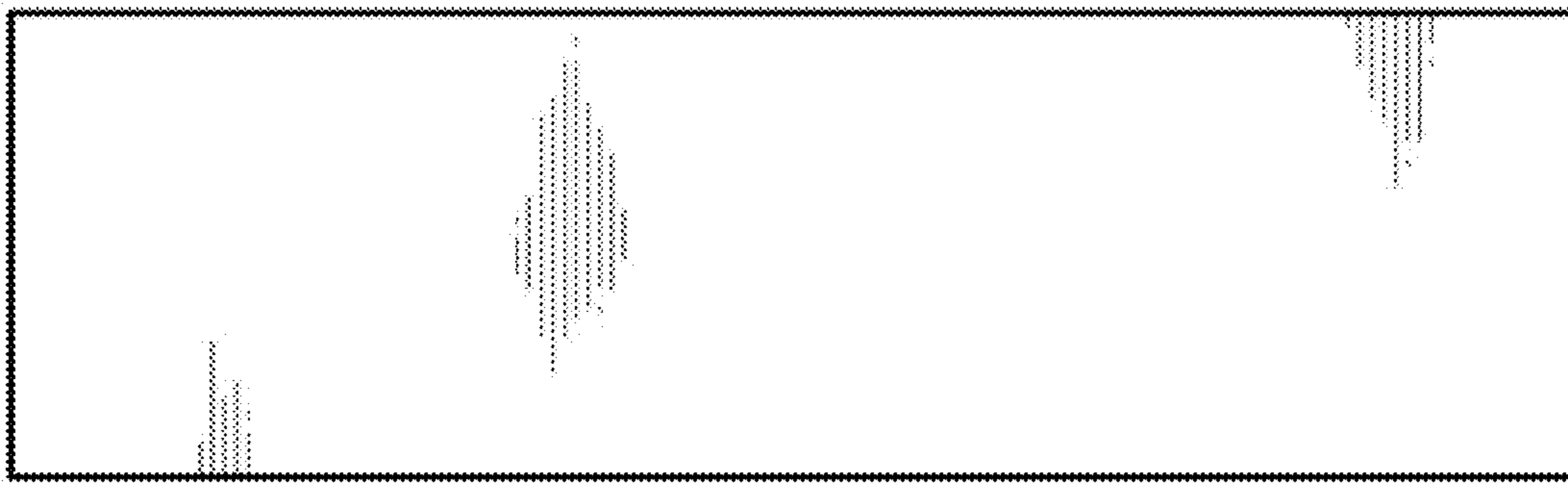

1.13

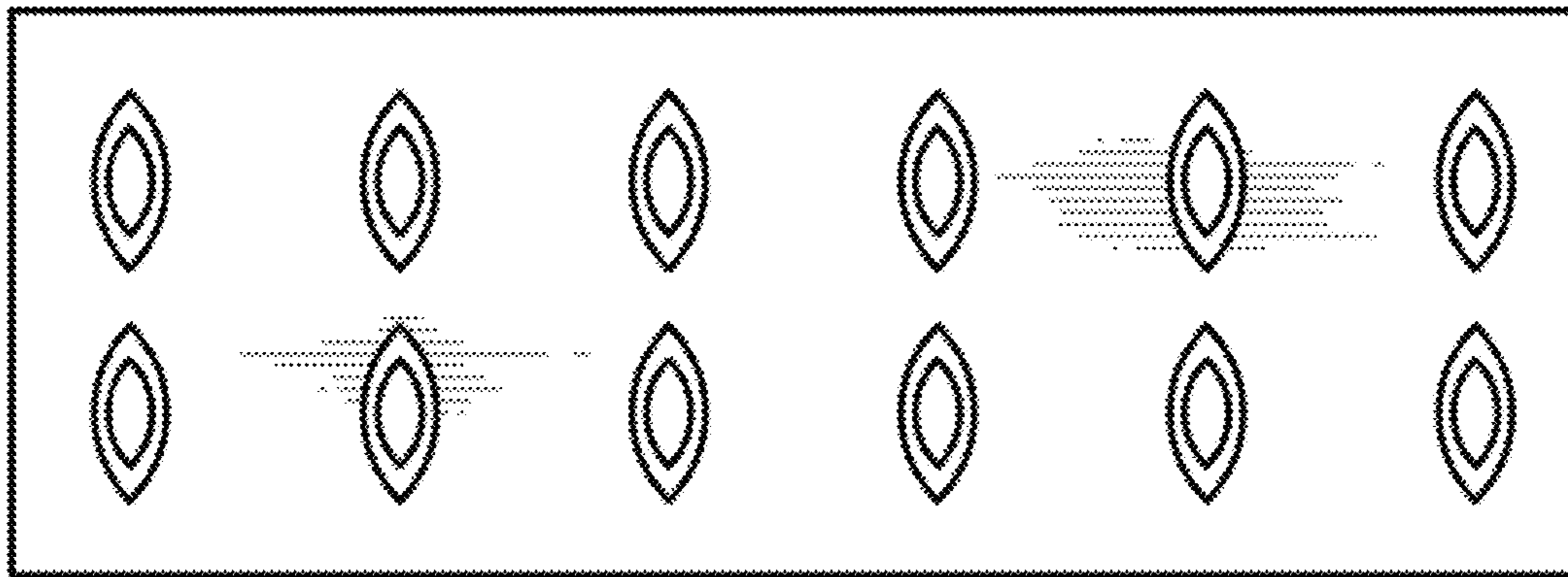

1.14

