



US00D835923S

(12) **United States Design Patent** (10) **Patent No.:** **US D835,923 S**
Buell et al. (45) **Date of Patent:** **** Dec. 18, 2018**

(54) **DISPENSER STAND**

(56) **References Cited**

(71) Applicant: **GOJO Industries, Inc.**, Akron, OH (US)
(72) Inventors: **Shelby Jay Buell**, Medina, OH (US); **Andrew P. Tojek**, Garfield Heights, OH (US); **Mark W. Moore**, Aurora, OH (US)
(73) Assignee: **GOJO Industries, Inc.**, Akron, OH (US)
(**) Term: **15 Years**
(21) Appl. No.: **29/631,834**
(22) Filed: **Jan. 3, 2018**

U.S. PATENT DOCUMENTS

D352,867 S *	11/1994	Morris	D7/589
D359,546 S *	6/1995	Savage	D23/207
D671,346 S *	11/2012	Zlatic	D23/208
D735,487 S *	8/2015	Marino	D6/515
D796,868 S *	9/2017	Johnson	D6/542
D812,395 S *	3/2018	Buell	D6/542
D812,928 S *	3/2018	Buell	D6/542
D814,208 S *	4/2018	Mann	D6/515
D815,454 S *	4/2018	Mann	D6/515
D818,739 S *	5/2018	Buell	D6/542

* cited by examiner

Primary Examiner — Wan Laymon
Assistant Examiner — Mark Booker

(74) *Attorney, Agent, or Firm* — Calfee, Halter & Griswold LLP

Related U.S. Application Data

(63) Continuation of application No. 29/585,808, filed on Nov. 29, 2016, now Pat. No. Des. 812,395.
(51) **LOC (11) Cl.** **23-02**
(52) **U.S. Cl.**
USPC **D6/542**; D6/515
(58) **Field of Classification Search**
USPC D6/542, 512, 513, 545, 543, 515;
D7/300, 306, 313, 397, 589; D9/733;
D20/1; D23/208; 206/225, 233, 389,
206/391; 211/13.1, 45; 221/26,
221/282–283; 222/108, 173
CPC A47K 5/00; B67D 3/0029; A47B 81/007;
A47F 9/04; F25D 2331/806; Y10T
225/238; A47G 19/183; A61C 15/043;
B65D 35/56; B65D 51/249
See application file for complete search history.

(57) **CLAIM**

The ornamental design for a dispenser stand, as shown and described.

DESCRIPTION

FIG. 1 is a perspective view of a dispenser stand of the new design;
FIG. 2 is front elevational view of the dispenser stand of FIG. 1;
FIG. 3 is a right side elevational view of the dispenser stand of FIG. 1;
FIG. 4 is a rear elevational view of the dispenser stand of FIG. 1;
FIG. 5 is a left side elevational view of the dispenser stand of FIG. 1;
FIG. 6 is a top plan view of the dispenser stand of FIG. 1; and,
FIG. 7 is bottom view of the dispenser stand of FIG. 1.
The broken lines shown in the Figures represent portions of the dispenser stand that form no part of the claimed design.

1 Claim, 4 Drawing Sheets

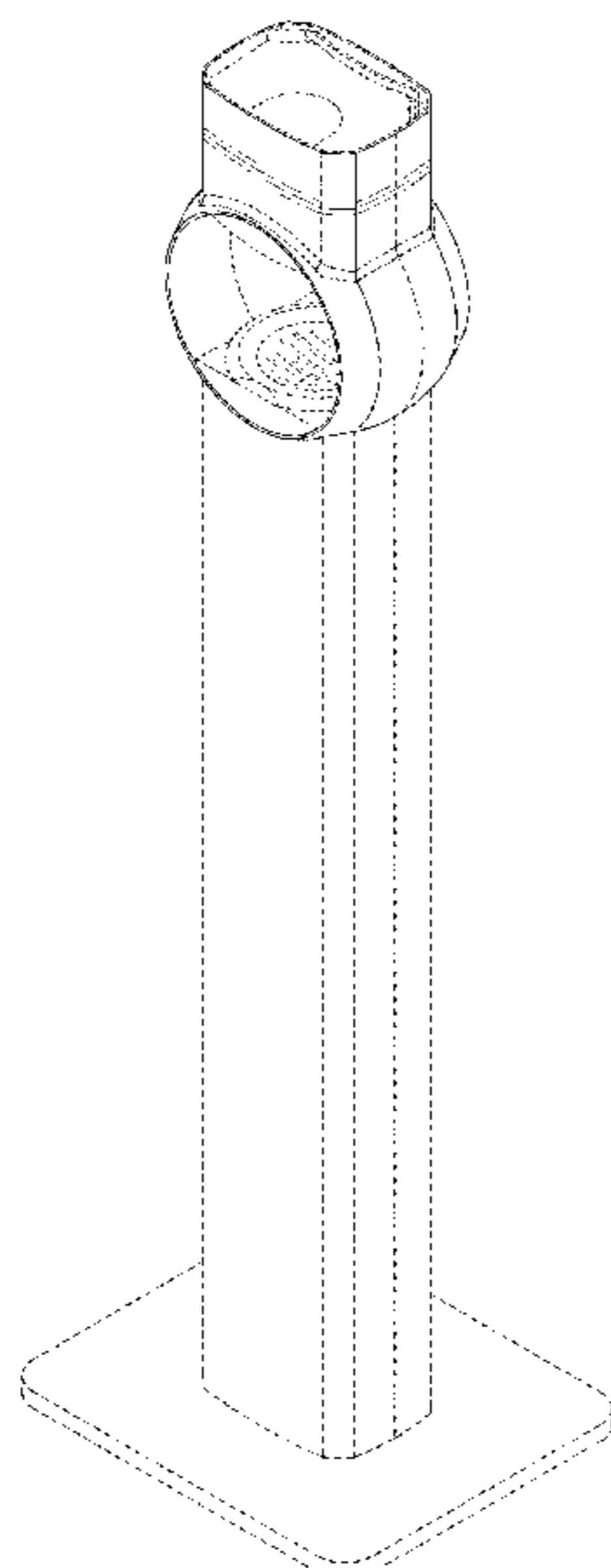

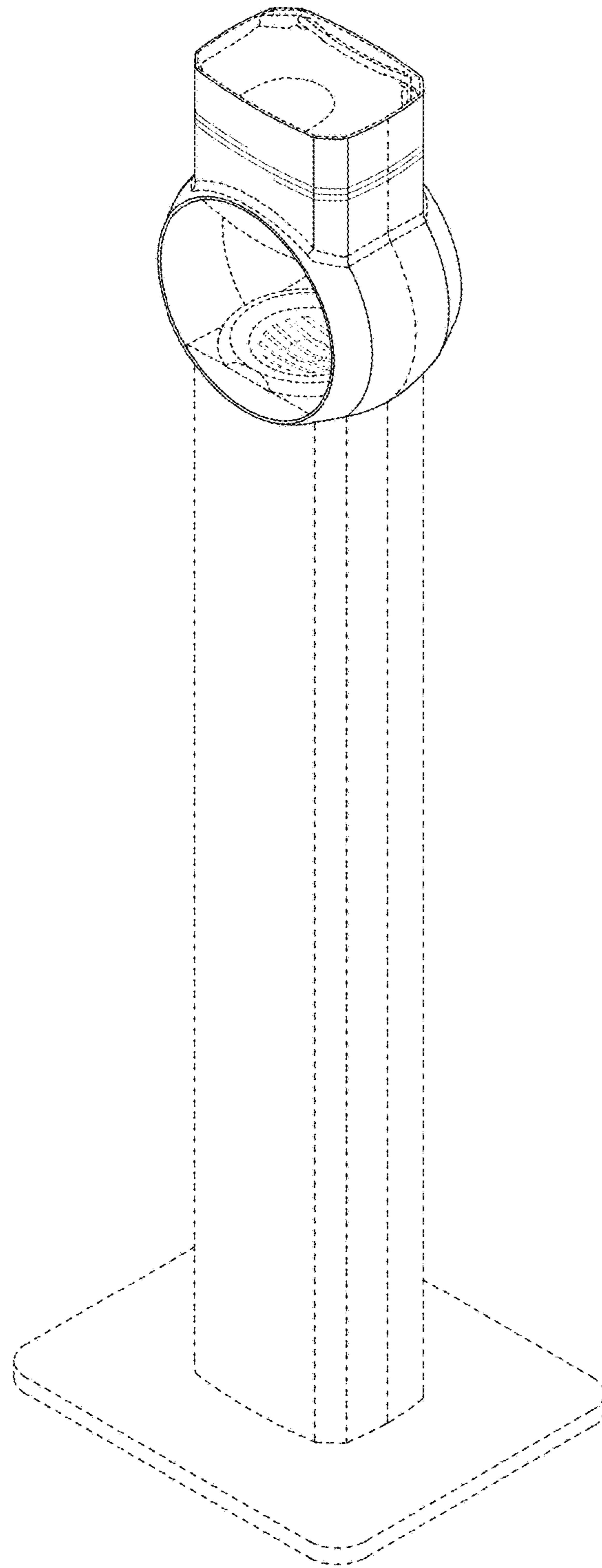

FIG. 1

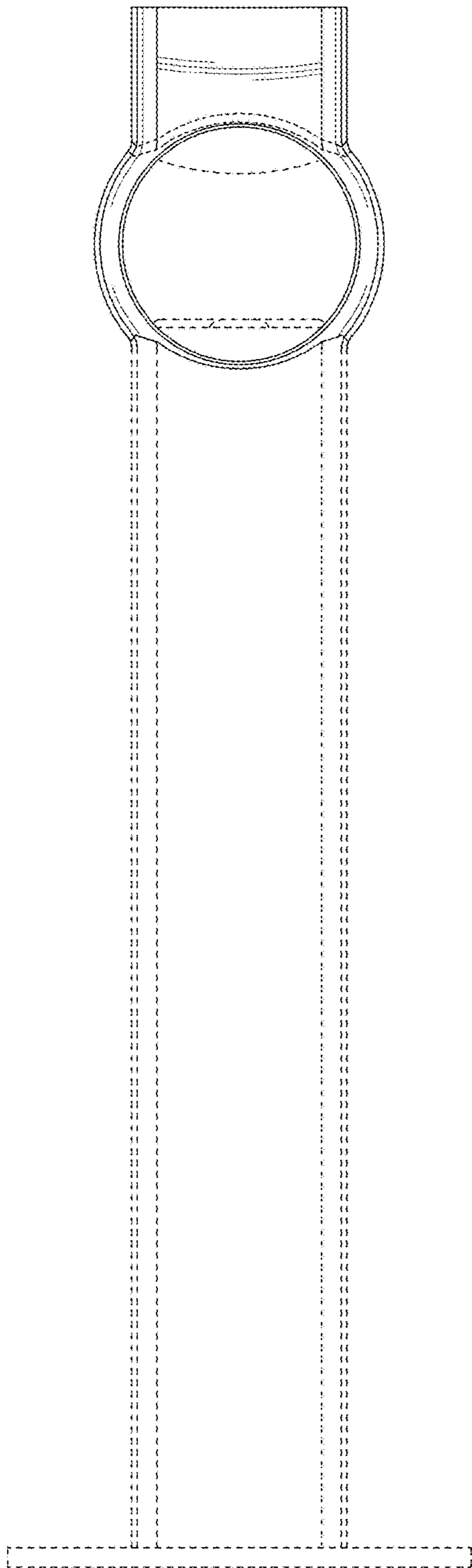

FIG. 2

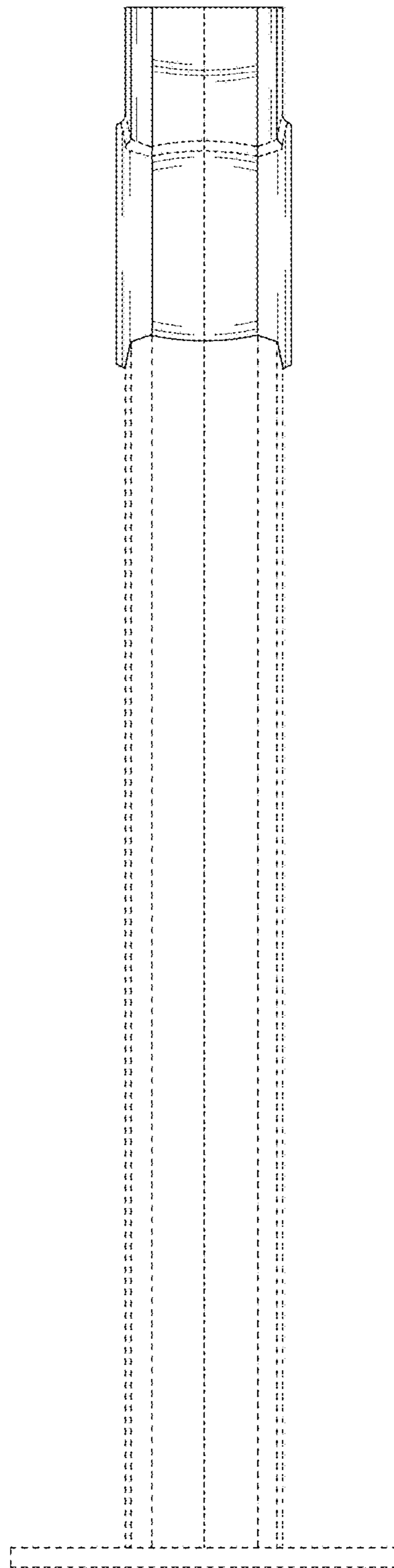

FIG. 3

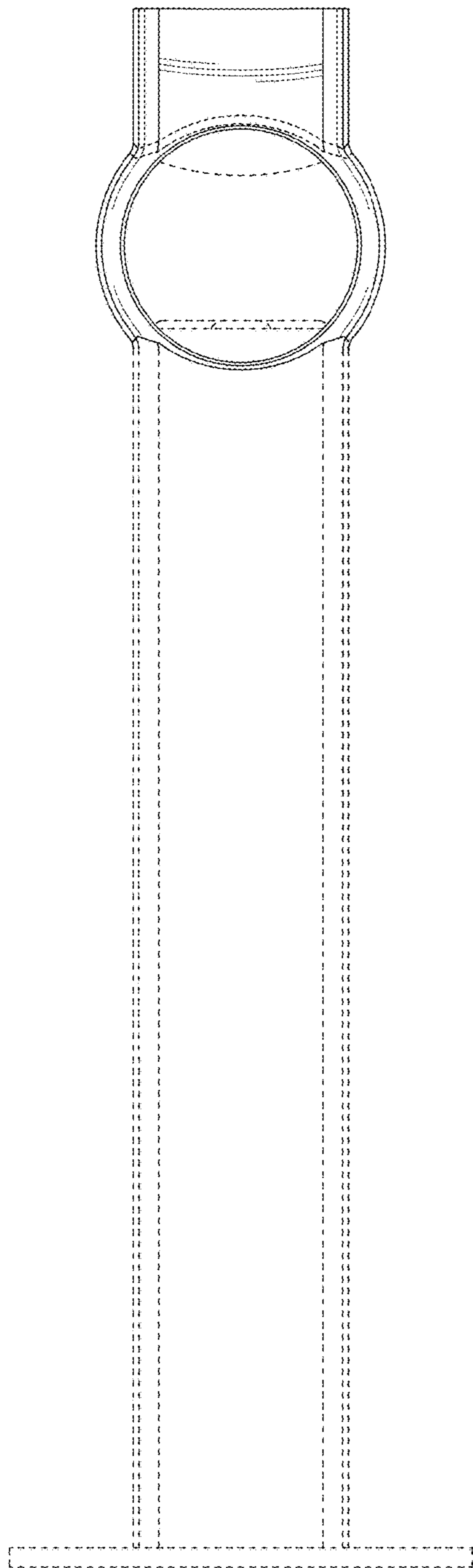

FIG. 4

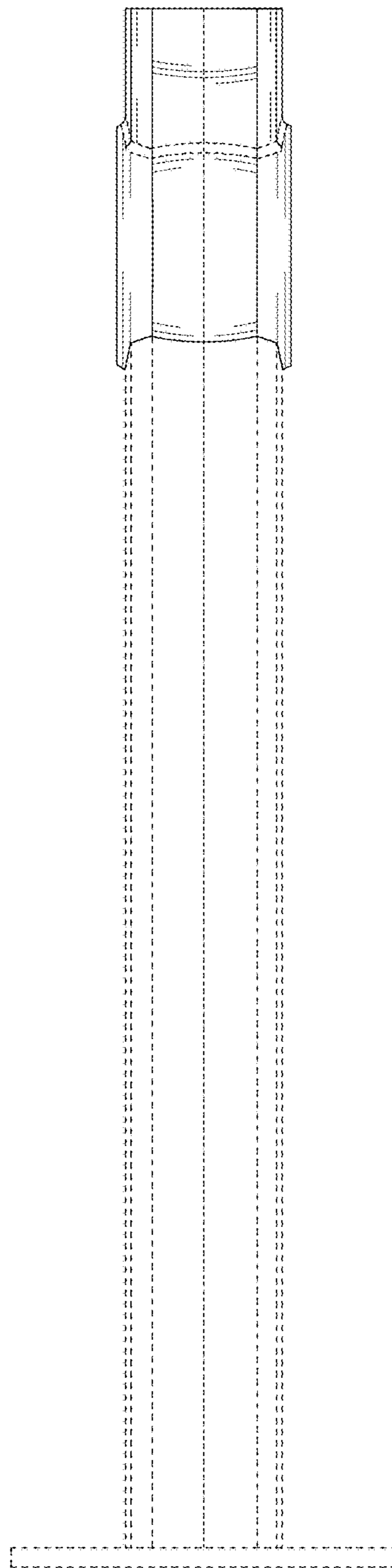

FIG. 5

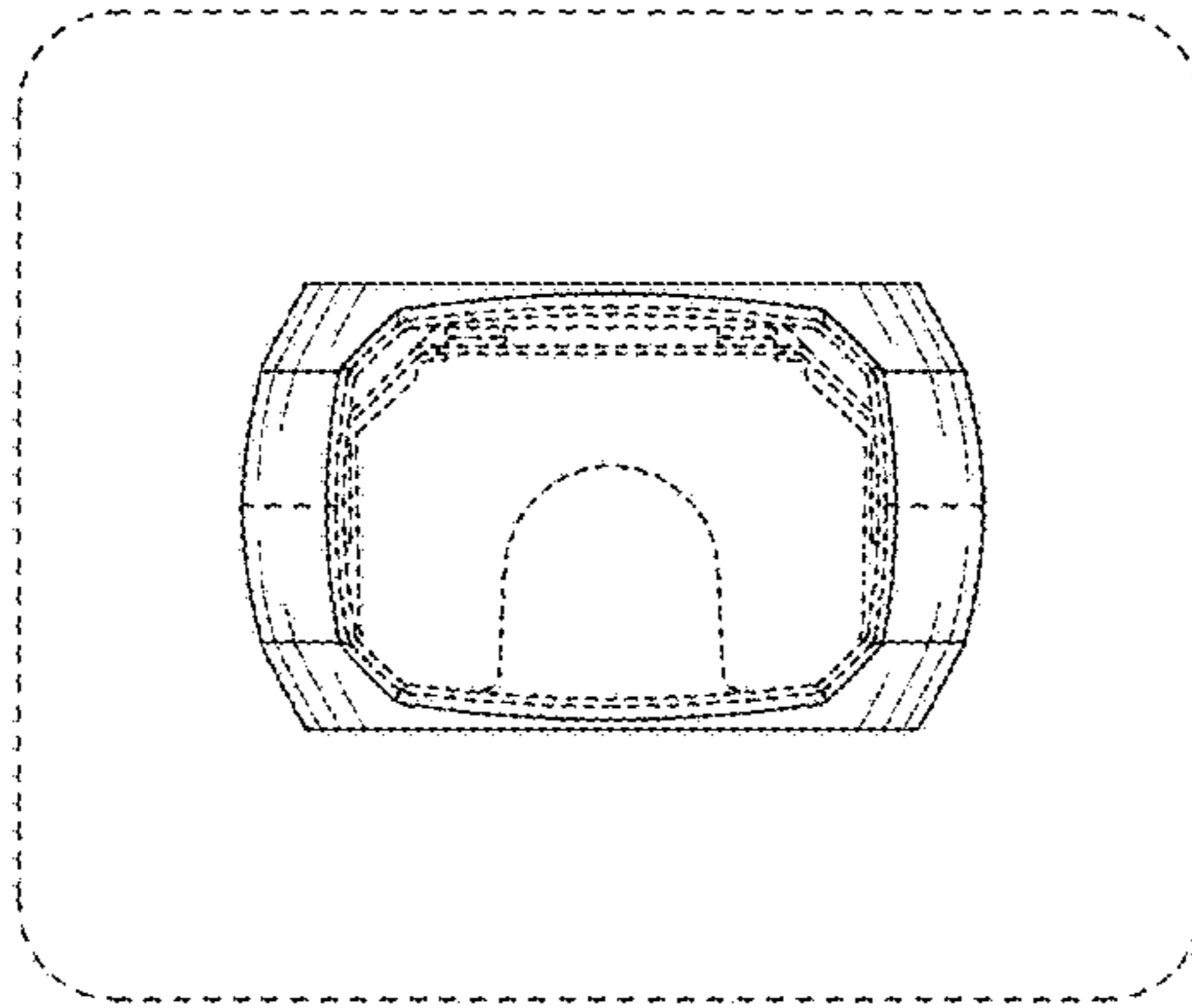

FIG. 6

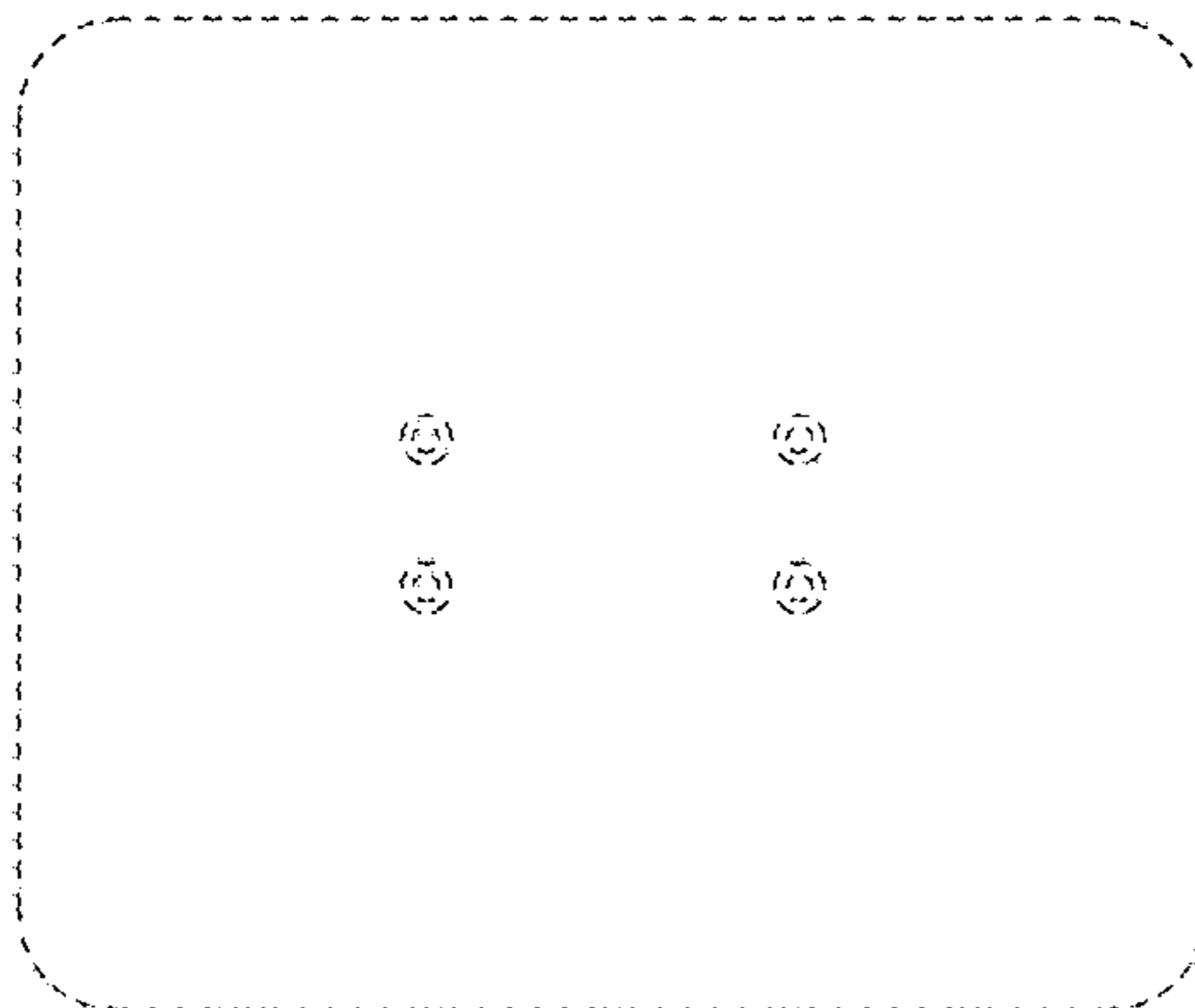

FIG. 7