

US00D835870S

(12) **United States Design Patent** (10) **Patent No.:** **US D835,870 S**
Kim (45) **Date of Patent:** **** Dec. 11, 2018**

(54) **DOOR FOR DRUM WASHING MACHINE**

FOREIGN PATENT DOCUMENTS

(71) Applicant: **SAMSUNG ELECTRONICS CO., LTD.**, Suwon-si, Gyeonggi-do (KR)

CN 303542646 S 1/2016
KR 300824965 8/2016

(Continued)

(72) Inventor: **Jinnam Kim**, Seoul (KR)

(73) Assignee: **SAMSUNG ELECTRONICS CO., LTD.**, Gyeonggi-do (KR)

OTHER PUBLICATIONS

Addwash 19kg WD19J9810KW white, (Copyright 1995-2016), pp. 1-13, Retrieved from Internet Dec. 20, 2016, <URL: <http://www.samsung.com/sec/consumer/living-appliances/washers-dryers/bubble-shot/WD19J9810KW>>.

(Continued)

(**) Term: **15 Years**

(21) Appl. No.: **29/647,270**

(22) Filed: **May 11, 2018**

Related U.S. Application Data

(63) Continuation of application No. 29/588,372, filed on Dec. 20, 2016, now Pat. No. Des. 819,284.

Primary Examiner — Cynthia Ramirez

Assistant Examiner — Laura H Yu

(74) *Attorney, Agent, or Firm* — Cantor Colburn LLP

(30) **Foreign Application Priority Data**

Aug. 26, 2016 (KR) 30-2016-0041872

(51) **LOC (11) Cl.** **15-05**

(52) **U.S. Cl.**
USPC **D32/25**

(58) **Field of Classification Search**

USPC D32/29.1, 29, 28, 6, 25, 8, 1, 5, 10;
312/288; 248/638, 673

CPC D06F 39/045; D06F 25/00; D06F 39/022;
D06F 33/02; D06F 2204/065; D06F
35/006; D06F 39/12; D06F 39/00; D06F
49/06; D06F 37/26; D06F 37/20; D06F
31/00; A47L 15/4418; F16M 9/00

See application file for complete search history.

(56) **References Cited**

U.S. PATENT DOCUMENTS

D700,409 S 2/2014 Takahashi
D706,999 S 6/2014 Cho et al.
D758,681 S 6/2016 Park et al.
D758,682 S 6/2016 Kim et al.

(Continued)

(57) **CLAIM**

The ornamental design for a door for drum washing machine, as shown and described.

DESCRIPTION

FIG. 1 is a perspective view of a door for drum washing machine, showing my new design;
FIG. 2 is a front view thereof;
FIG. 3 is a rear view thereof;
FIG. 4 is a side view thereof;
FIG. 5 is another side view thereof;
FIG. 6 is a top view thereof;
FIG. 7 is a bottom view thereof; and,
FIG. 8 is another perspective view thereof in an environment of use.

The broken lines in the figures illustrate portions of the door for drum washing machine that form no part of the claimed design. The additional broken lines in FIG. 8 illustrate environment that form no part of the claimed design.

1 Claim, 7 Drawing Sheets

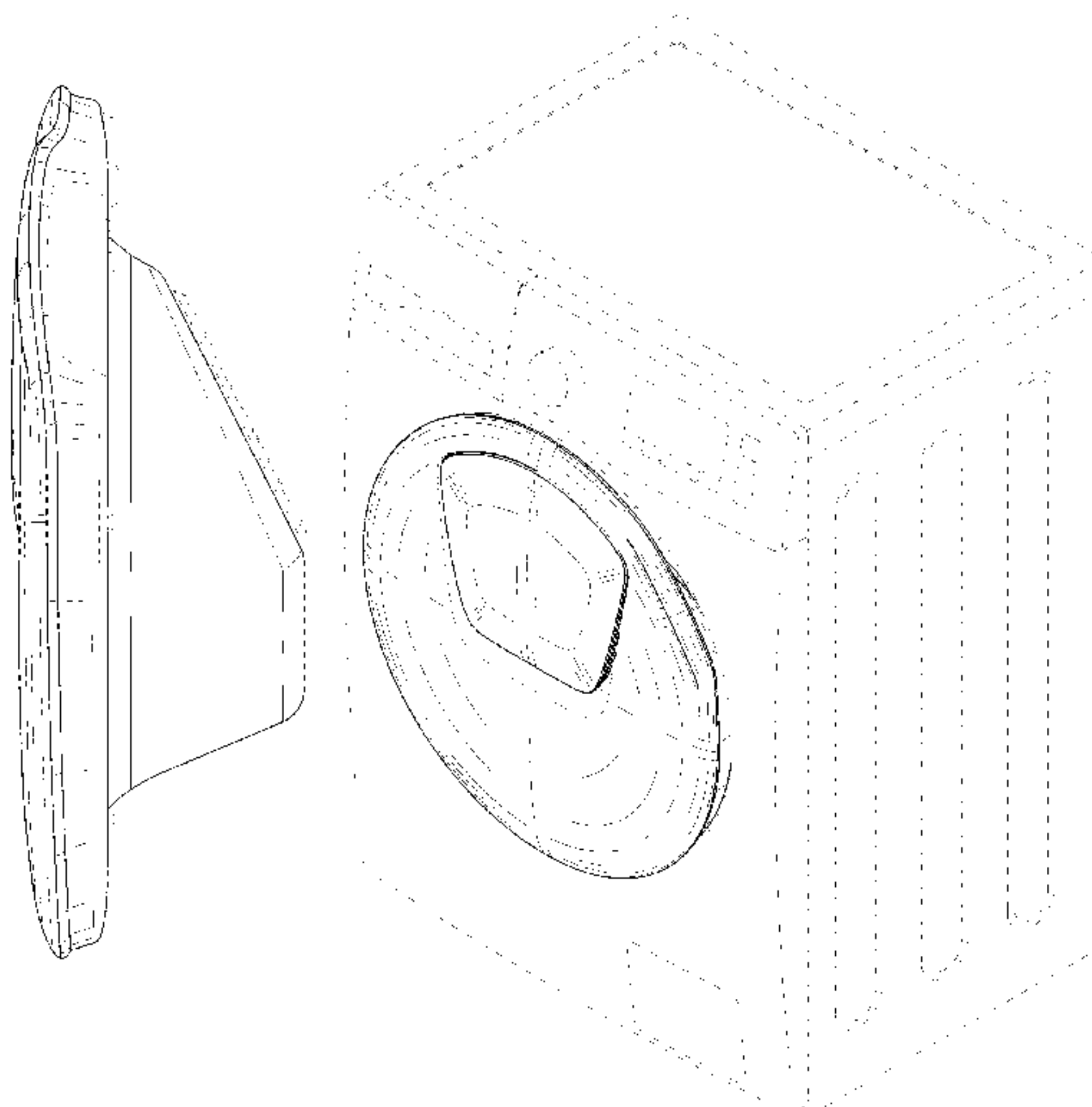

(56)

References Cited

U.S. PATENT DOCUMENTS

D772,499 S	11/2016	Yoon et al.	
D772,502 S	11/2016	Choi et al.	
D773,753 S	12/2016	Kim et al.	
D774,714 S	12/2016	Kang et al.	
D781,007 S	3/2017	Jang et al.	
D785,256 S	4/2017	Yoon et al.	
D785,882 S	5/2017	Kim et al.	
D791,419 S	7/2017	Kim et al.	
D792,663 S	7/2017	Kim et al.	
D793,013 S	7/2017	Kang et al.	
D794,266 S	8/2017	Yoon et al.	
D794,267 S	8/2017	Kang et al.	
D819,284 S *	5/2018	Kim	D32/25
D821,045 S *	6/2018	Kim	D32/25

FOREIGN PATENT DOCUMENTS

RU	00099638	7/2016
TR	201507180	12/2015

OTHER PUBLICATIONS

Samsung Add Wash posted by Review.com posted date Jan. 8, 2016, © YouTube, [online], [site visited Sep. 12, 2017]. Available from Internet, <https://www.youtube.com/watch?v=qQalwyHBbws>.

Samsung Washing Machine posted by Appliances Online Australia posted date Aug. 3, 2016, © YouTube, [online], [site visited Sep. 12, 2017]. Available from Internet, <https://www.youtube.com/watch?v=3bErlgz06Fs>.

Samsung Washing Machine posted by CNET posted date Jan. 5, 2016, © YouTube, [online], [site visited Sep. 12, 2017]. Available from Internet, <https://www.youtube.com/watch?v=9EORO3KiRjM>.

* cited by examiner

FIG. 1

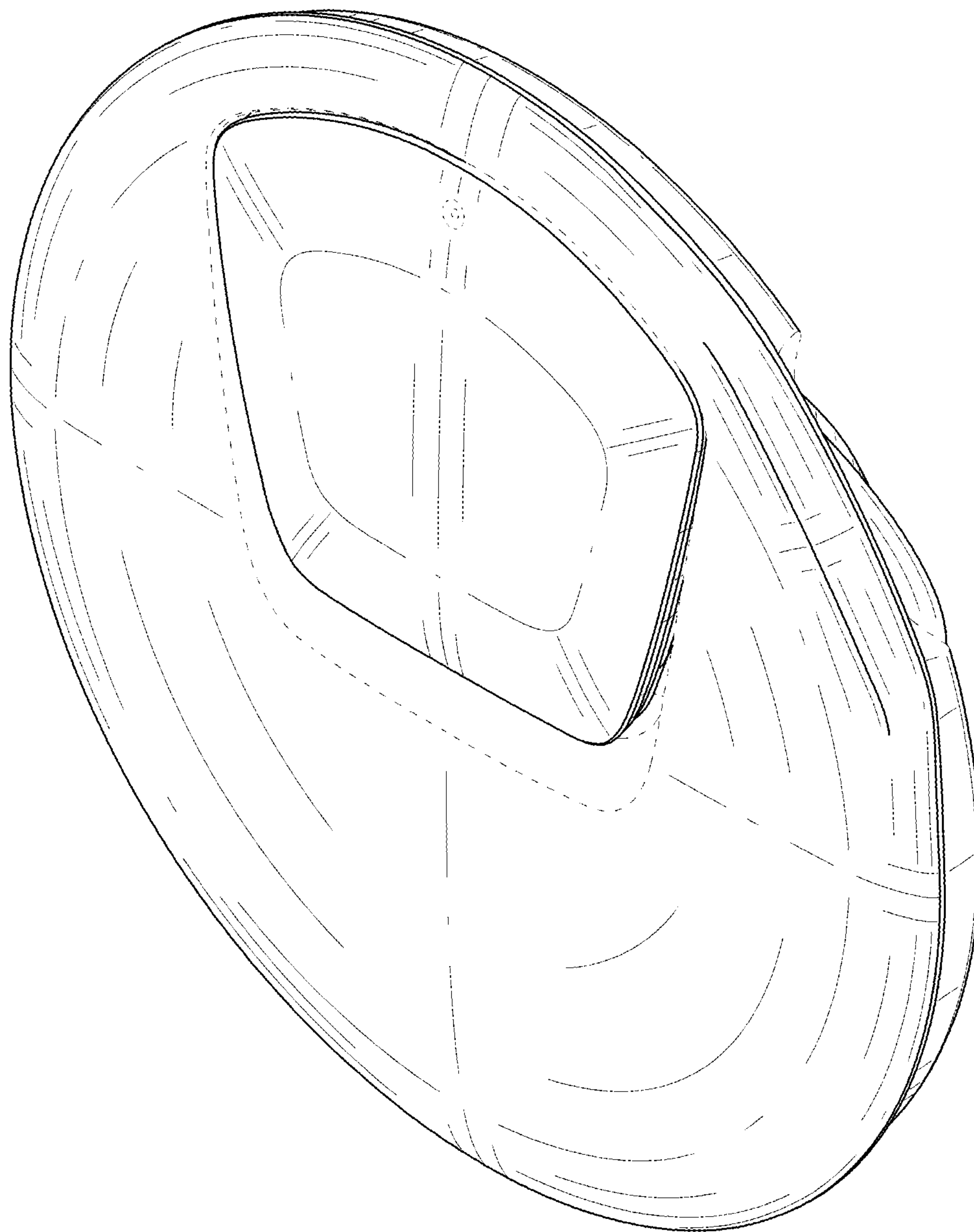

FIG. 2

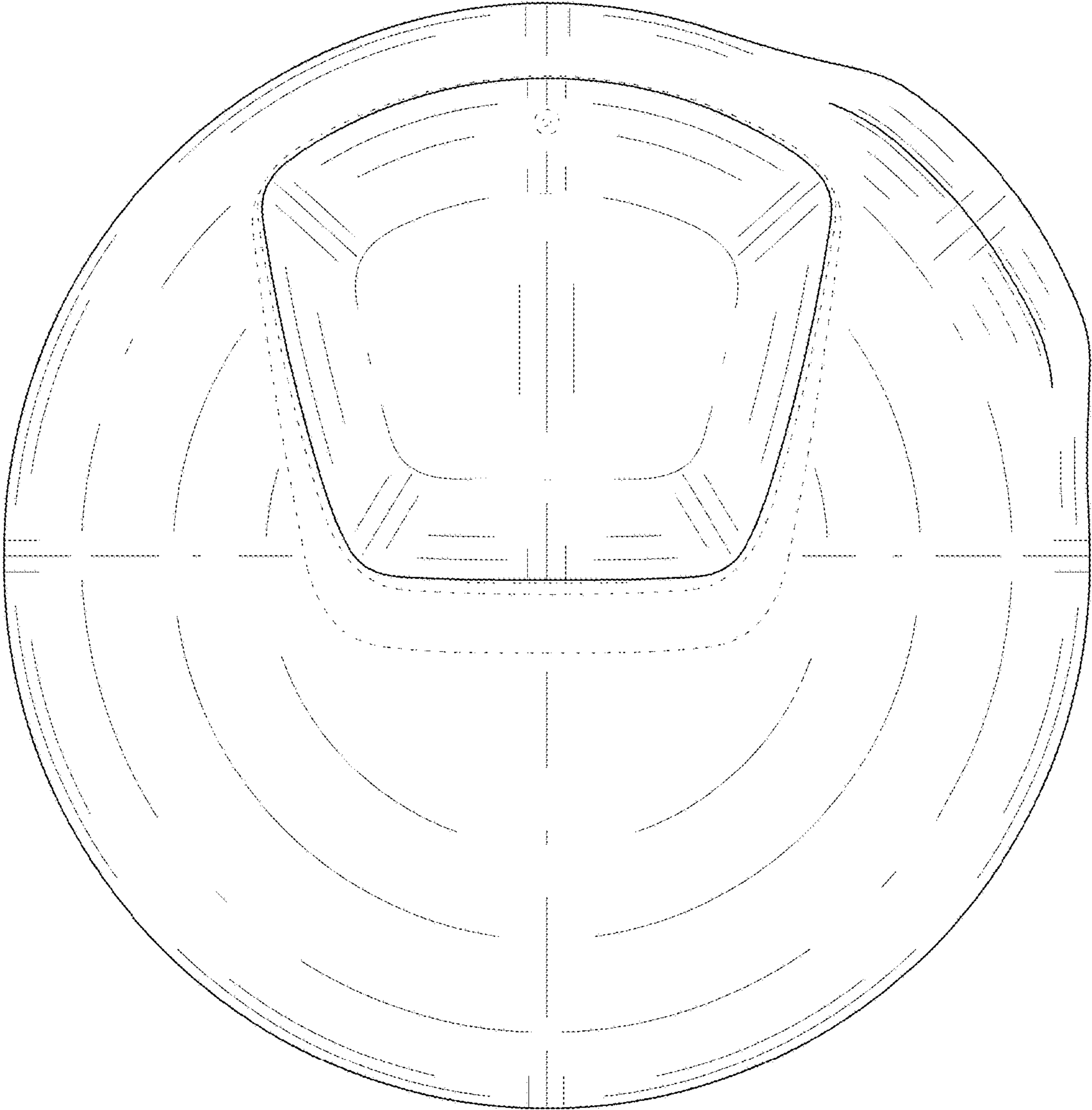

FIG. 3

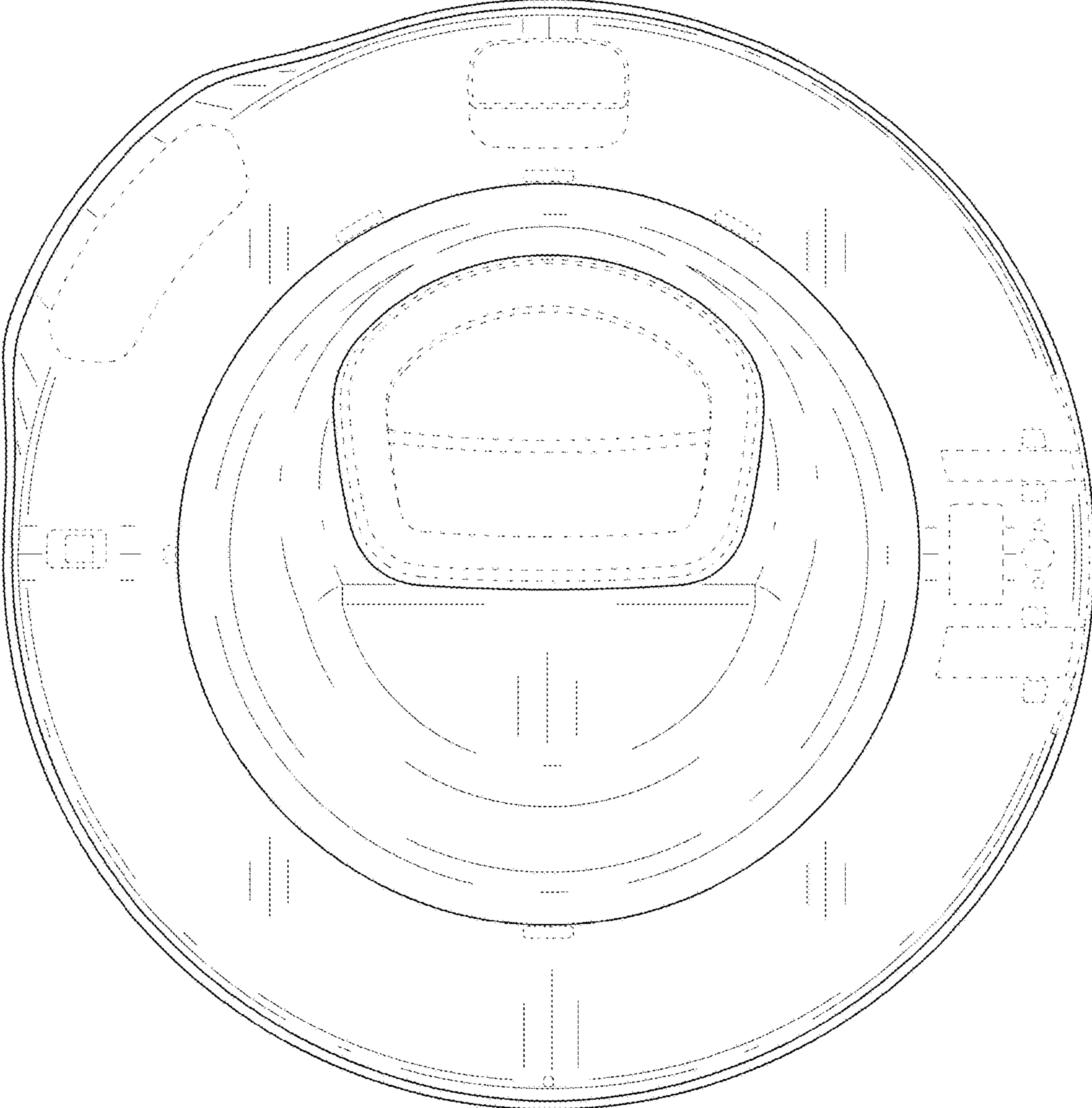

FIG. 4

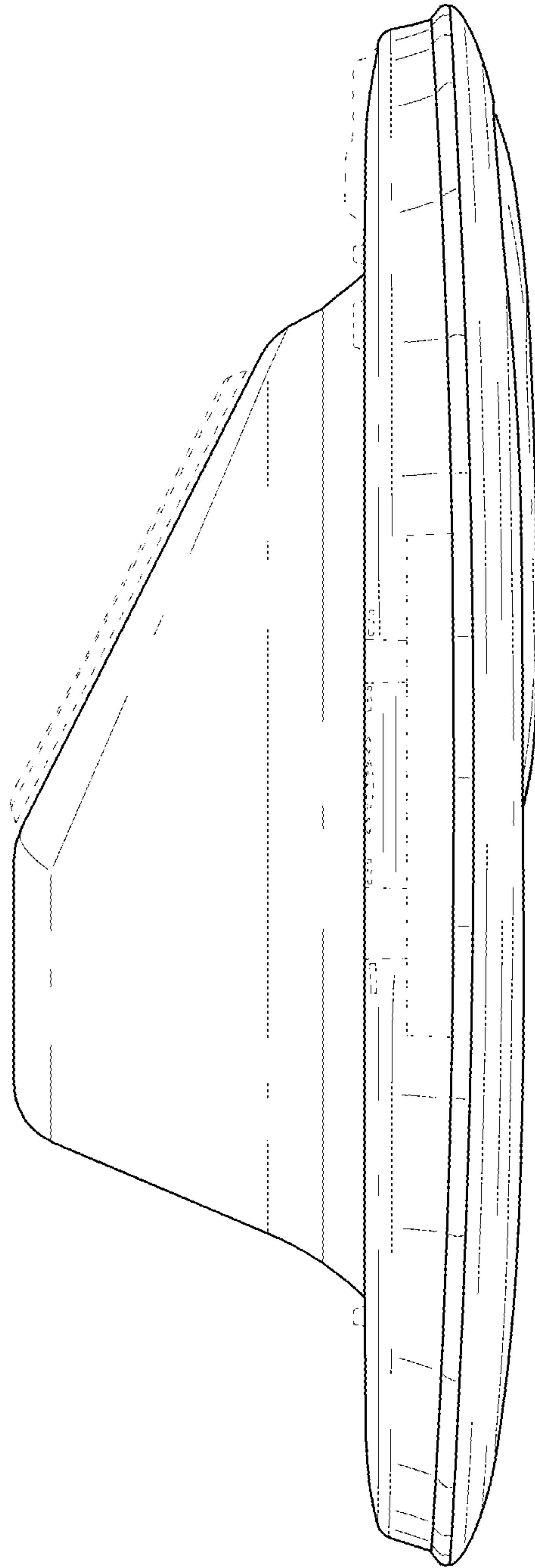

FIG. 5

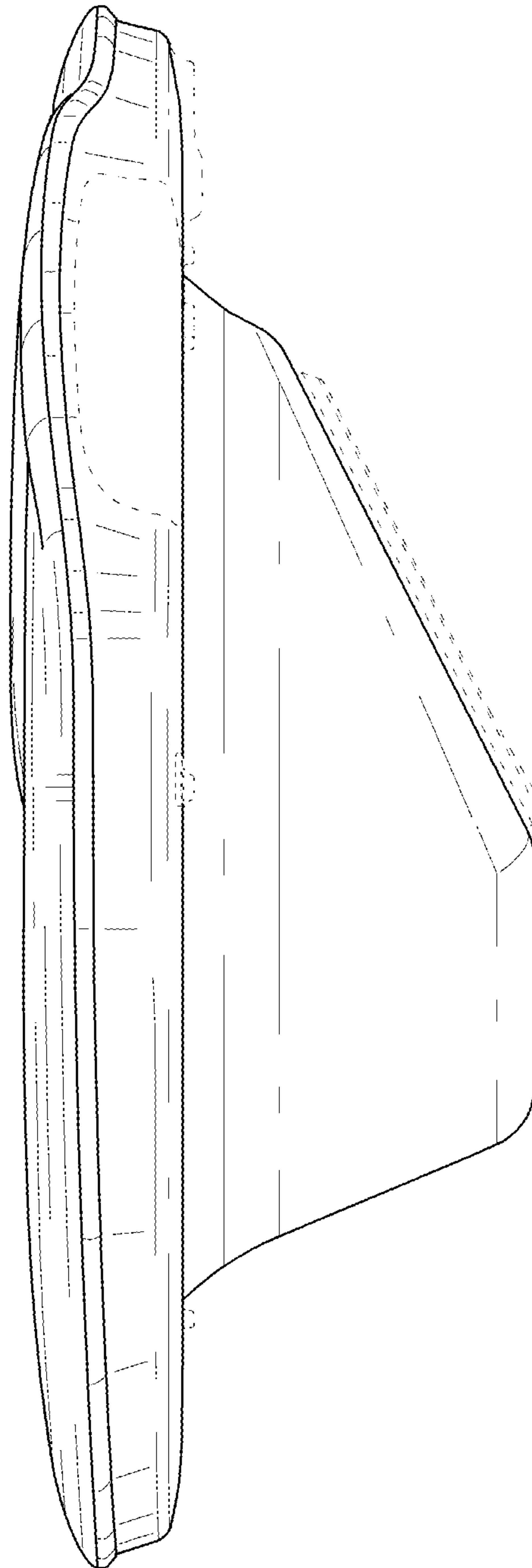

FIG. 6

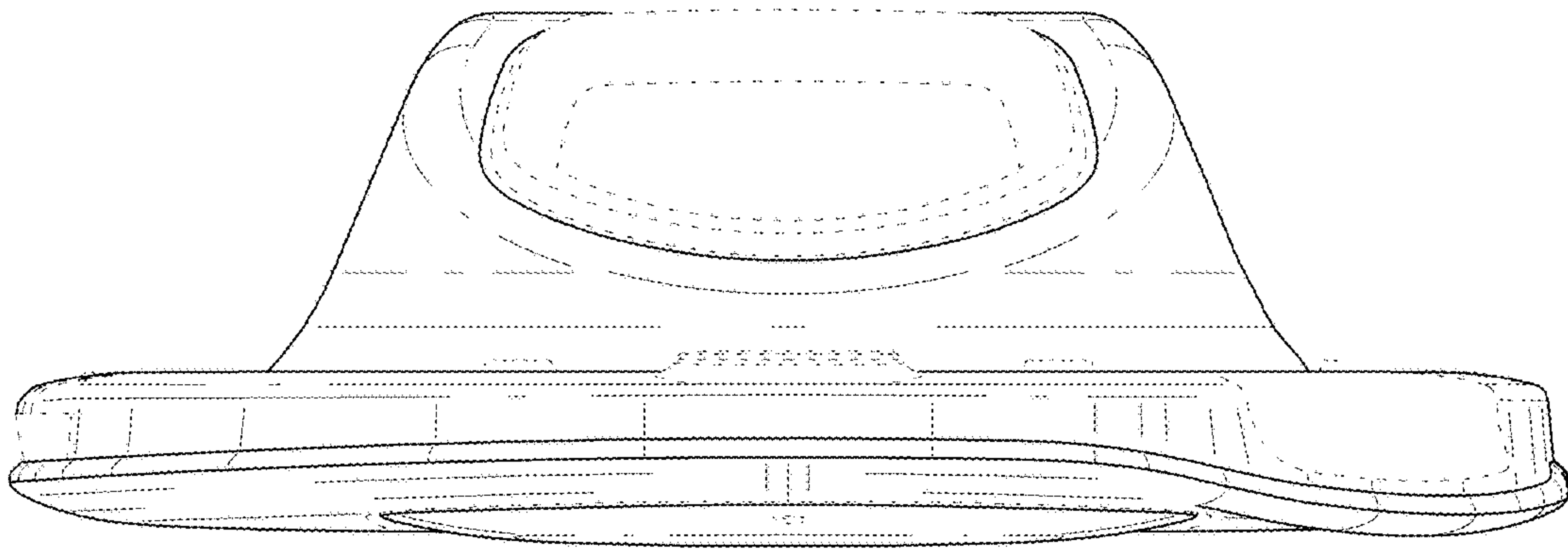

FIG. 7

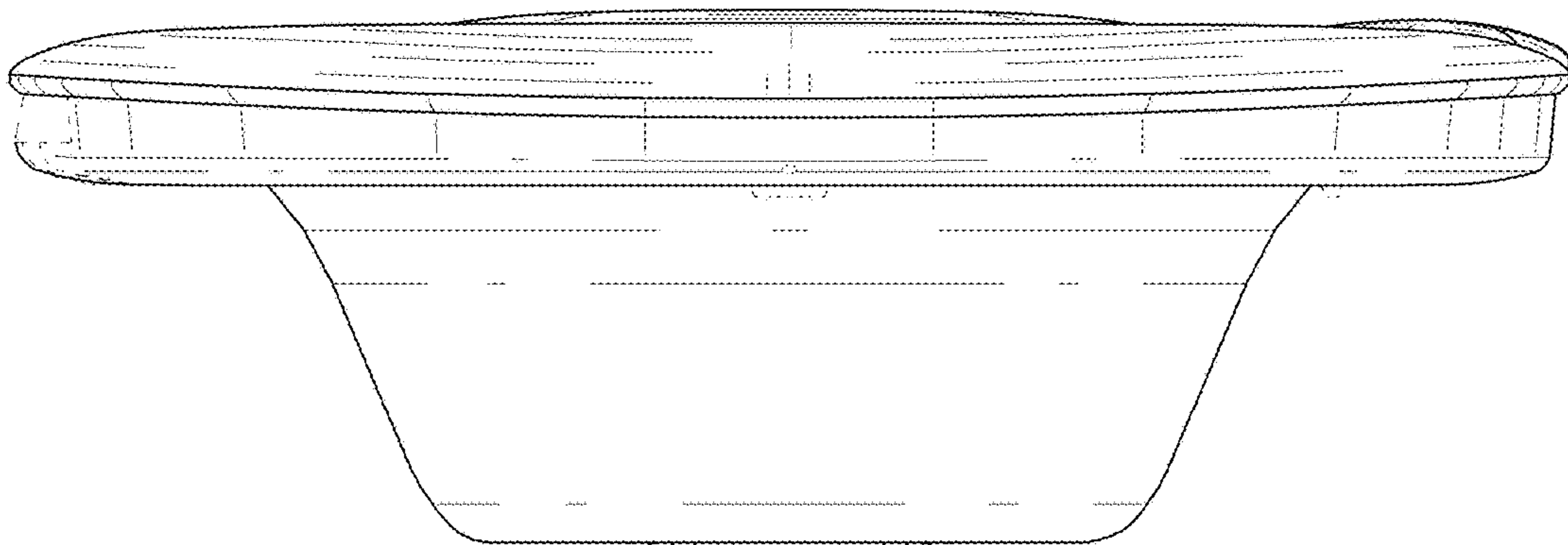

FIG. 8

